



FEATURES

P1dB output power: 28 dBm typical

Gain: 15.5 dB typical

Output IP3: 39 dBm typical

Self biased at $V_{DD} = 12\text{ V}$ at 345 mA typical

Optional bias control on V_{GG1} for I_{DQ} adjustment

Optional bias control on V_{GG2} for IP2 and IP3 optimization

50 Ω matched input/output

32-lead, 5 mm \times 5 mm LFCSP package: 25 mm²

APPLICATIONS

Military and space

Test instrumentation

FUNCTIONAL BLOCK DIAGRAM

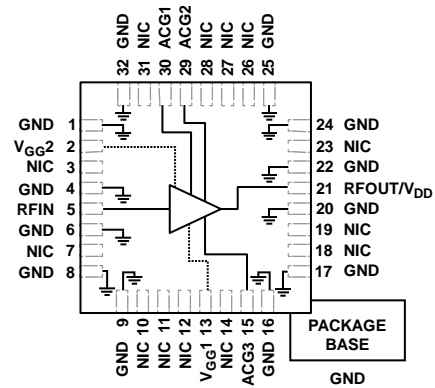

Figure 1.

GENERAL DESCRIPTION

The HMC637BPM5E is a gallium arsenide (GaAs), monolithic microwave integrated circuit (MMIC), pseudomorphic high electron mobility transistor (pHEMT), cascode distributed power amplifier. The device is self biased in normal operation and features optional bias control for quiescent current (I_{DQ}) adjustment and for second-order intercept (IP2) and third-order intercept (IP3) optimization. The amplifier operates from dc to 7.5 GHz, providing 15.5 dB of small signal gain, 28 dBm output power at 1 dB gain compression, a typical output IP3 of 39 dBm,

and a 3.5 dB noise figure, while requiring 345 mA from a 12 V supply voltage (V_{DD}). Gain flatness is excellent from dc to 7.5 GHz at ± 0.5 dB typical, making the HMC637BPM5E ideal for military, space, and test equipment applications. The HMC637BPM5E also features inputs/outputs (I/Os) that are internally matched to 50 Ω , housed in a RoHS-compliant, 5 mm \times 5 mm, premolded cavity, lead frame chip scale package (LFCSP), making the device compatible with high volume, surface-mount technology (SMT) assembly equipment.

TABLE OF CONTENTS

Features	1	Interface Schematics	6
Applications	1	Typical Performance Characteristic	7
Functional Block Diagram	1	Theory of Operation	17
General Description	1	Applications Information	18
Revision History	2	Typical Application Circuit	19
Specifications	3	Evaluation PCB.....	20
Frequency Range = DC to 7.5 GHz	3	Bill of Materials	20
Absolute Maximum Ratings	4	Outline Dimensions.....	21
Thermal Resistance	4	Ordering Guide	21
ESD Caution.....	4		
Pin Configuration and Function Descriptions	5		

REVISION HISTORY

8/2020—Rev. 0 to Rev. A

Changes to Figure 17 Caption	8
Added Figure 68; Renumbered Sequentially	16

5/2018—Revision 0: Initial Version

SPECIFICATIONS**FREQUENCY RANGE = DC TO 7.5 GHz**

$T_A = 25^\circ\text{C}$, $V_{DD} = 12\text{ V}$, $I_{DQ} = 345\text{ mA}$, $V_{GG1} = \text{GND}$, $V_{GG2} = \text{open}$, for nominal self biased operation, unless otherwise noted.

Table 1.

Parameter	Symbol	Min	Typ	Max	Unit	Test Conditions/Comments
FREQUENCY RANGE		DC		7.5	GHz	
GAIN		12.5	15.5		dB	
Gain Flatness			± 0.5		dB	
Gain Variation over Temperature			± 0.015		dB/ $^\circ\text{C}$	
NOISE FIGURE			3.5		dB	
RETURN LOSS						
Input			15		dB	
Output			15		dB	
OUTPUT						
Output Power for 1 dB Compression	P1dB	25	28		dBm	Measurement taken at output power (P_{OUT})/ tone = 10 dBm
Saturated Output Power	P_{SAT}		30.5		dBm	
Output Third-Order Intercept	IP3		39		dBm	
SUPPLY						
Current	I_{DQ}		345		mA	For the external bias condition, adjust the gate bias voltage (V_{GG1}) between -2 V up to $+0.5\text{ V}$ to achieve the desired quiescent current (I_{DQ})
Voltage	V_{DD}	8	12	13	V	

ABSOLUTE MAXIMUM RATINGS

Table 2.

Parameter ¹	Rating
Drain Bias Voltage (V_{DD})	14 V
Gate 1 Voltage (V_{GG1})	-2 V to +1 V
Gate 2 Voltage (V_{GG2})	3.5 V to 7 V
Radio Frequency (RF) Input Power (RFIN)	25 dBm
Continuous Power Dissipation (P_{DISS}), T = 85°C (Derate 63.29 mW/°C Above 85°C)	5.7 W
Output Load Voltage Standing Wave Ratio (VSWR)	7:1
Storage Temperature Range	-65°C to +150°C
Operating Temperature Range	-55°C to +85°C
Maximum Peak Reflow Temperature	260°C
ESD Sensitivity	
Human Body Model (HBM)	Class 1C
Junction Temperature to Maintain 1 Million Hour Mean Time to Failure (MTTF)	175°C
Nominal Junction Temperature (T = 85°C, V_{DD} = 12 V)	148.52°C

¹ When referring to a single function of a multifunction pin in the parameters, only the portion of the pin name that is relevant to the specification is listed. For full pin names of the multifunction pins, refer to the Pin Configuration and Function Descriptions section.

Stresses at or above those listed under Absolute Maximum Ratings may cause permanent damage to the product. This is a stress rating only; functional operation of the product at these or any other conditions above those indicated in the operational section of this specification is not implied. Operation beyond the maximum operating conditions for extended periods may affect product reliability.

THERMAL RESISTANCE

Thermal performance is directly linked to printed circuit board (PCB) design and operating environment. Careful attention to PCB thermal design is required.

θ_{JC} is the junction to case thermal resistance.

Table 3. Thermal Resistance

Package	θ_{JC}	Unit
CG-32-2 ¹	15.8	°C/W

¹ Thermal impedance simulated values are based on a JEDEC 252P thermal test board with 36 thermal vias. See JEDEC JESD51.

ESD CAUTION



ESD (electrostatic discharge) sensitive device. Charged devices and circuit boards can discharge without detection. Although this product features patented or proprietary protection circuitry, damage may occur on devices subjected to high energy ESD. Therefore, proper ESD precautions should be taken to avoid performance degradation or loss of functionality.

PIN CONFIGURATION AND FUNCTION DESCRIPTIONS

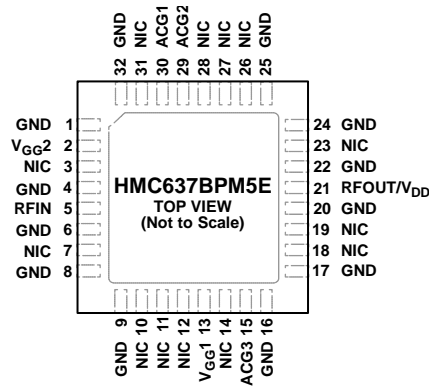

- NOTES**
- EXPOSED PAD. THE EXPOSED PAD MUST BE CONNECTED TO RF/DC GROUND.
 - NIC = NOT INTERNALLY CONNECTED.

16273-002

Figure 2. Pin Configuration

Table 4. Pin Function Descriptions

Pin No.	Mnemonic	Description
1, 4, 6, 8, 9, 16, 17, 20, 22, 24, 25, 32	GND	Ground. These pins and the exposed pad must be connected to RF/dc ground.
2	V _{GG2}	Gate Control 2 for the Amplifier. V _{GG2} is left open for self biased mode. Adjusting the voltage controls the gain response. External capacitors are required (see Figure 70). See Figure 7 for the interface schematic.
3, 7, 10 to 12, 14, 18, 19, 23, 26 to 28, 31	NIC	Not Internally Connected. These pins must be connected to RF/dc ground.
5	RFIN	RF Input. This pin is dc-coupled and matched to 50 Ω. See Figure 6 for the interface schematic.
13	V _{GG1}	Optional Gate Control for the Amplifier. If this pin is grounded, the amplifier runs in self biased mode at the standard current of 345 mA. Adjusting the voltage above or below the ground potential controls the drain current. External capacitors are required (see Figure 70). See Figure 8 for the interface schematic.
15, 29, 30	ACG1, ACG2, ACG3	Low Frequency Termination. External bypass capacitors are required on these pins (see Figure 70). See Figure 4 and Figure 5 for the interface schematics.
21	RFOUT/V _{DD}	RF Output for the Amplifier (RFOUT). Drain Bias Voltage (V _{DD}). Connect the dc bias (V _{DD}) network to provide the drain current, I _{DD} (see Figure 70). See Figure 5 for the interface schematic.
	EPAD	Exposed Pad. The exposed pad must be connected to RF/dc ground.

INTERFACE SCHEMATICS



Figure 3. GND Interface Schematic

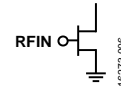

Figure 6. RFIN Interface Schematic

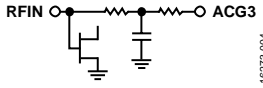

Figure 4. ACG3 Interface Schematic

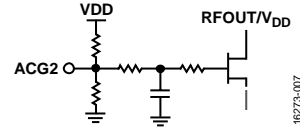

Figure 7. VGG2 Interface Schematic

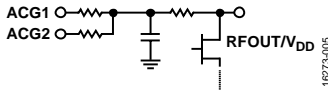

Figure 5. RFOUT/VDD, ACG1, ACG2 Interface Schematic

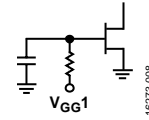

Figure 8. VGG1 Interface Schematic

TYPICAL PERFORMANCE CHARACTERISTIC

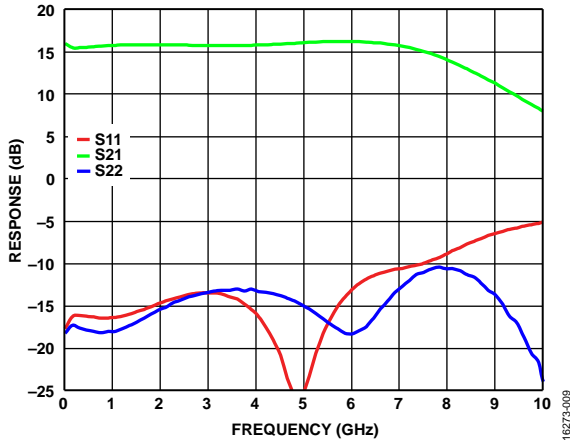

Figure 9. Gain and Return Loss Response vs. Frequency, Self Biased Mode, $V_{DD} = 12\text{ V}$, $V_{GG1} = \text{GND}$, $V_{GG2} = \text{Open}$

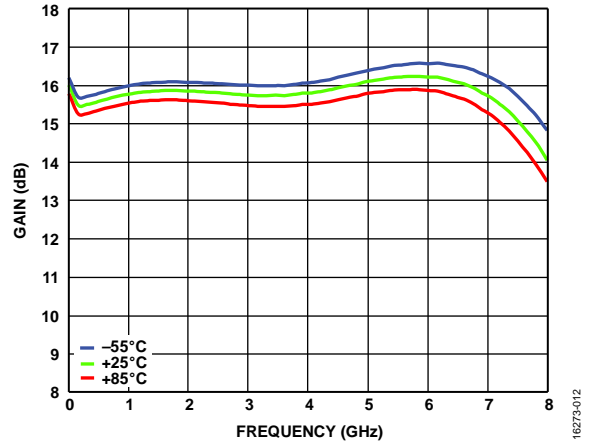

Figure 12. Gain vs. Frequency for Various Temperatures, Self Biased Mode, $V_{DD} = 12\text{ V}$, $V_{GG1} = \text{GND}$, $V_{GG2} = \text{Open}$

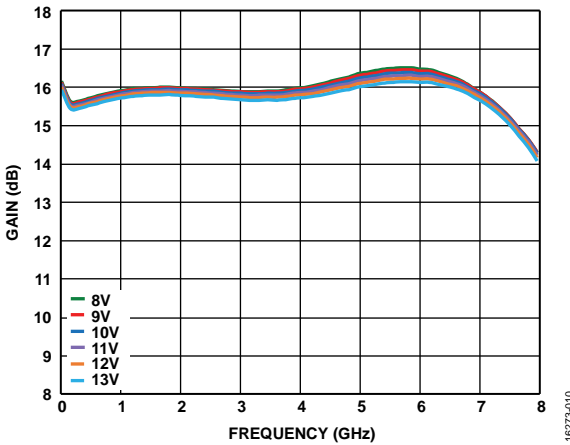

Figure 10. Gain vs. Frequency for Various Supply Voltages (V_{DD}), Self Biased Mode, $V_{GG1} = \text{GND}$, $V_{GG2} = \text{Open}$

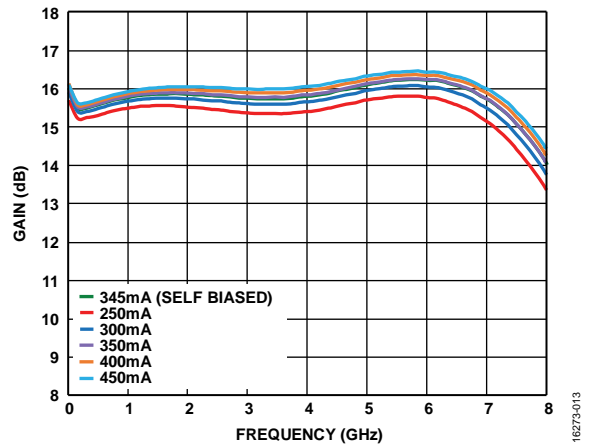

Figure 13. Gain vs. Frequency for Various Supply Currents (I_{DD}), Externally Biased Mode, $V_{DD} = 12\text{ V}$, $V_{GG2} = \text{Open}$, Controlled V_{GG1}

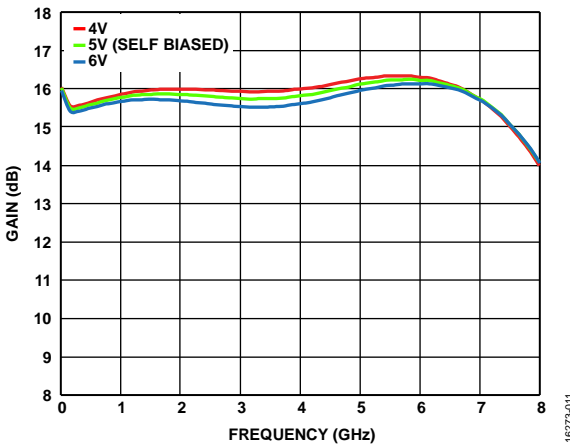

Figure 11. Gain vs. Frequency for Various V_{GG2} Values, $V_{DD} = 12\text{ V}$, $V_{GG1} = \text{GND}$

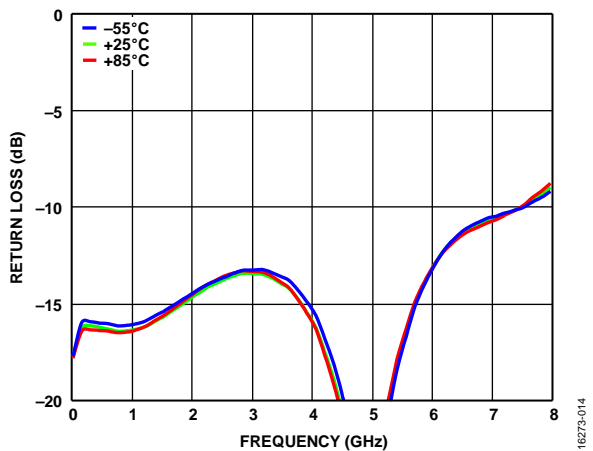

Figure 14. Input Return Loss vs. Frequency for Various Temperatures, Self Biased Mode, $V_{DD} = 12\text{ V}$, $V_{GG1} = \text{GND}$, $V_{GG2} = \text{Open}$

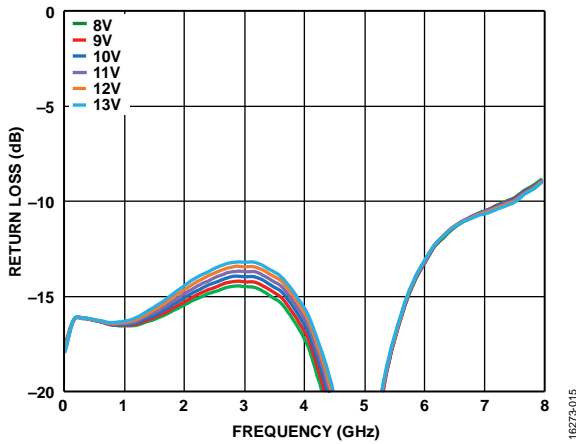

Figure 15. Input Return Loss vs. Frequency for Various Supply Voltages (V_{DD}), Self Biased Mode, $V_{GG2} = \text{Open}$, $V_{GG1} = \text{GND}$

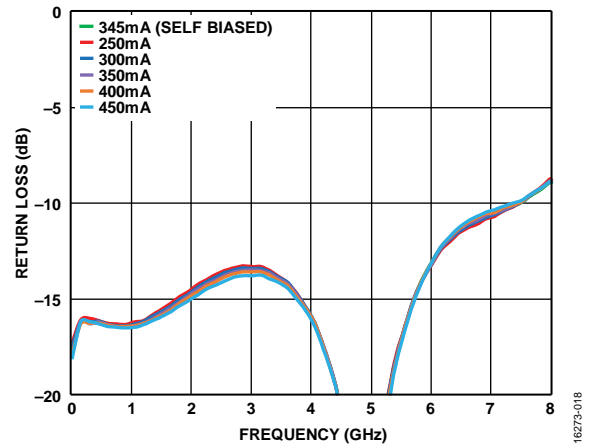

Figure 18. Input Return Loss vs. Frequency for Various Supply Currents (I_{DD}), Externally Biased Mode, $V_{DD} = 12 \text{ V}$, $V_{GG2} = \text{Open}$, Controlled V_{GG1}

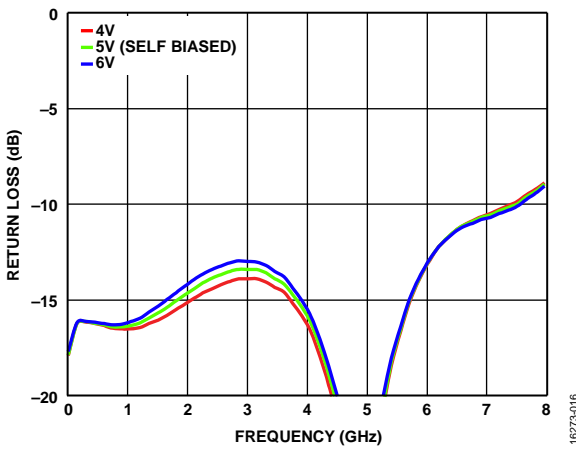

Figure 16. Input Return Loss vs. Frequency for Various V_{GG2} Values, $V_{DD} = 12 \text{ V}$, $V_{GG1} = \text{GND}$

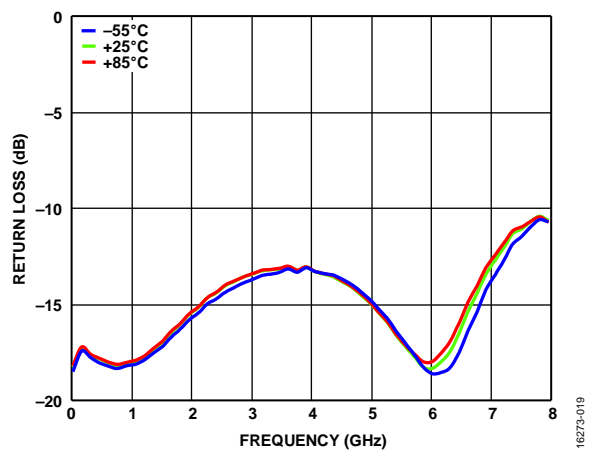

Figure 19. Output Return Loss vs. Frequency for Various Temperatures, Self Biased Mode, $V_{DD} = 12 \text{ V}$, $V_{GG2} = \text{Open}$, $V_{GG1} = \text{GND}$

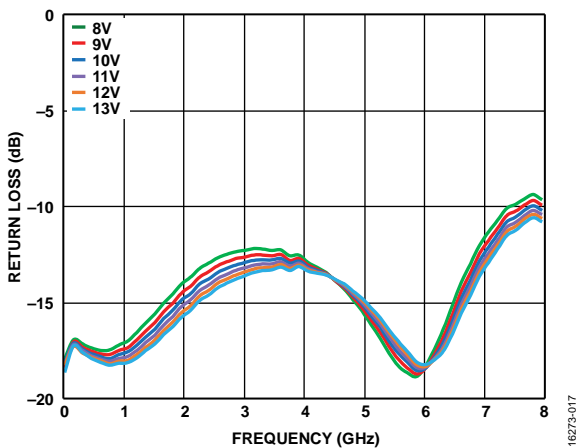

Figure 17. Output Return Loss vs. Frequency for Various Supply Voltages (V_{DD}), Self Biased Mode, $V_{GG2} = \text{Open}$, $V_{GG1} = \text{GND}$

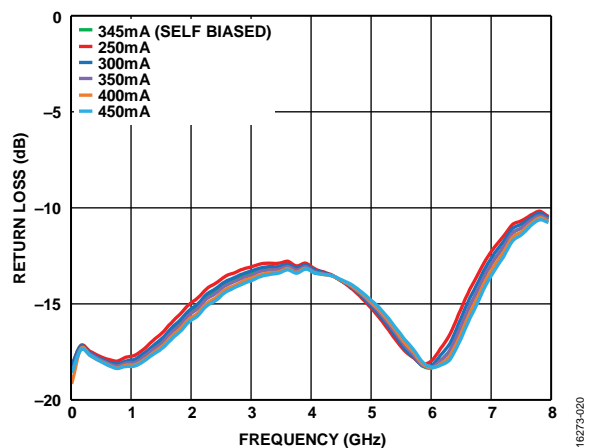

Figure 20. Output Return Loss vs. Frequency for Various Supply Currents (I_{DD}), External Biased condition, $V_{DD} = 12 \text{ V}$, $V_{GG2} = \text{Open}$, Controlled V_{GG1}

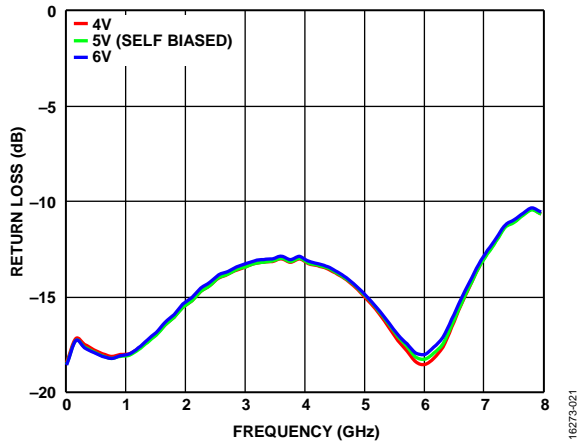

Figure 21. Output Return Loss vs. Frequency for Various V_{GG2} Values, $V_{DD} = 12\text{ V}$, $V_{GG1} = \text{GND}$

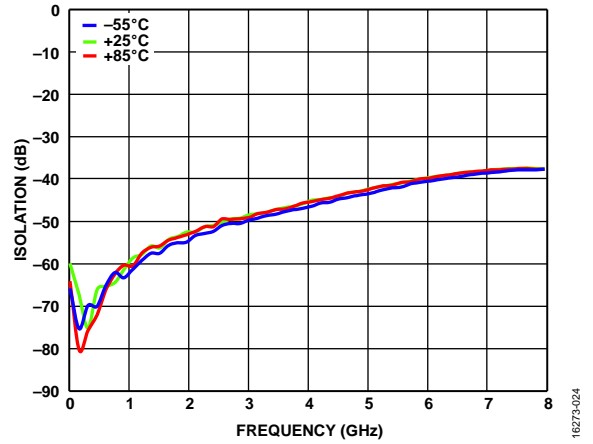

Figure 24. Reverse Isolation vs. Frequency for Various Temperatures, Self Biased Mode, $V_{DD} = 12\text{ V}$, $V_{GG2} = \text{Open}$, $V_{GG1} = \text{GND}$

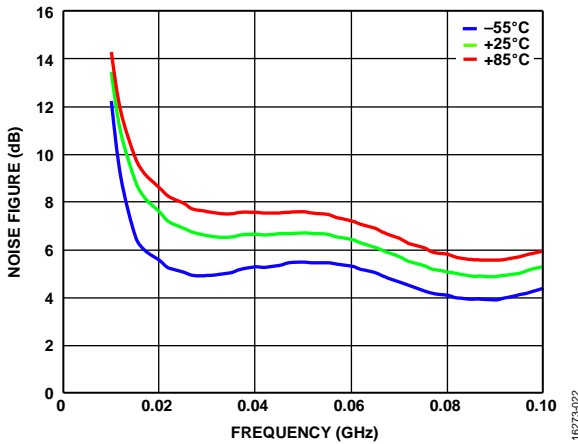

Figure 22. Noise Figure vs. Low Frequency for Various Temperatures, Self Biased Mode, $V_{DD} = 12\text{ V}$, $V_{GG2} = \text{Open}$, $V_{GG1} = \text{GND}$

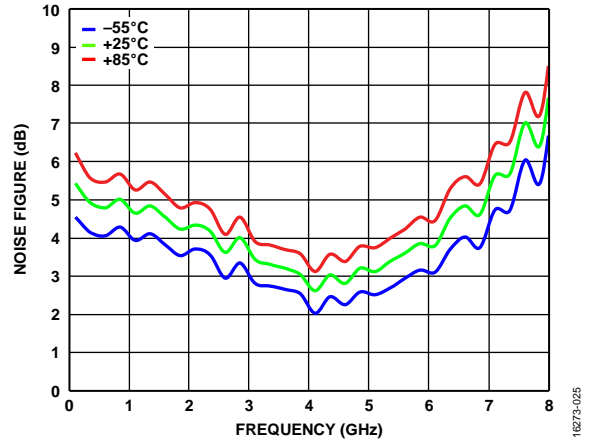

Figure 25. Noise Figure vs. Frequency for Various Temperatures, Self Biased Mode, $V_{DD} = 12\text{ V}$, $V_{GG2} = \text{Open}$, $V_{GG1} = \text{GND}$

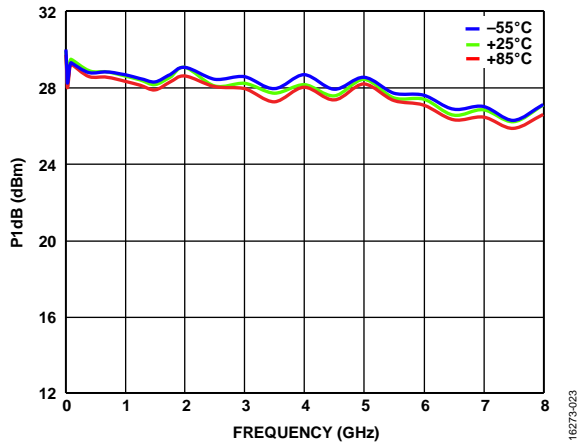

Figure 23. P1dB vs. Frequency for Various Temperatures, Self Biased Mode, $V_{DD} = 12\text{ V}$, $V_{GG2} = \text{Open}$, $V_{GG1} = \text{GND}$

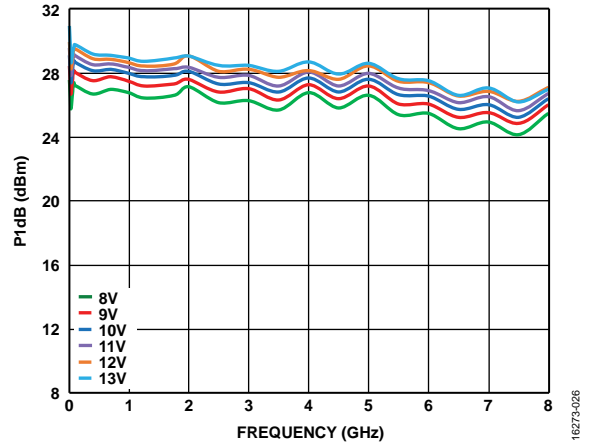

Figure 26. P1dB vs. Frequency for Various Supply Voltages (V_{DD}), $V_{GG2} = \text{Open}$, $V_{GG1} = \text{GND}$

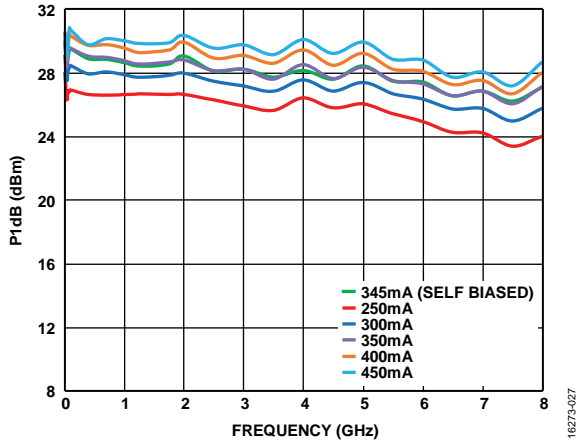

Figure 27. P1dB vs. Frequency for Various Supply Currents (I_{DD}), Externally Biased Mode, $V_{DD} = 12\text{ V}$, $V_{GG2} = \text{Open}$, Controlled V_{GG1}

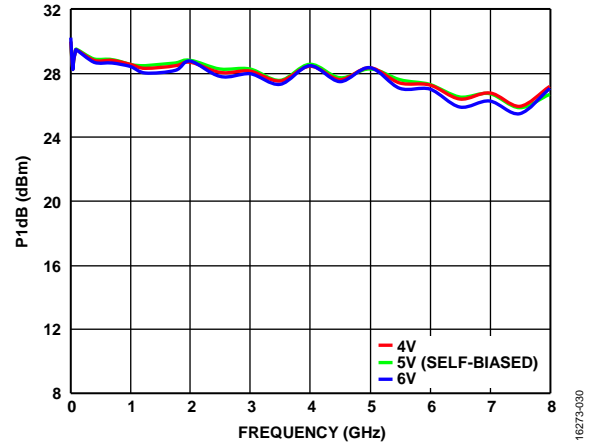

Figure 30. P1dB vs. Frequency for Various V_{GG2} Values, $V_{DD} = 12\text{ V}$, $V_{GG1} = \text{GND}$

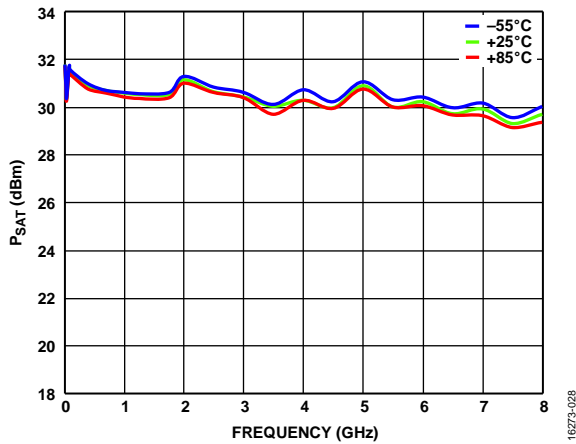

Figure 28. P_{SAT} vs. Frequency for Various Temperatures, Self Biased Mode, $V_{DD} = 12\text{ V}$, $V_{GG2} = \text{Open}$, $V_{GG1} = \text{GND}$

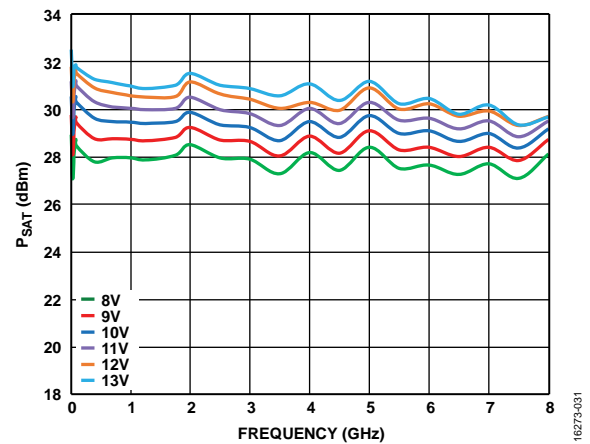

Figure 31. P_{SAT} vs. Frequency for Various Supply Voltages (V_{DD}), $V_{GG2} = \text{Open}$, $V_{GG1} = \text{GND}$

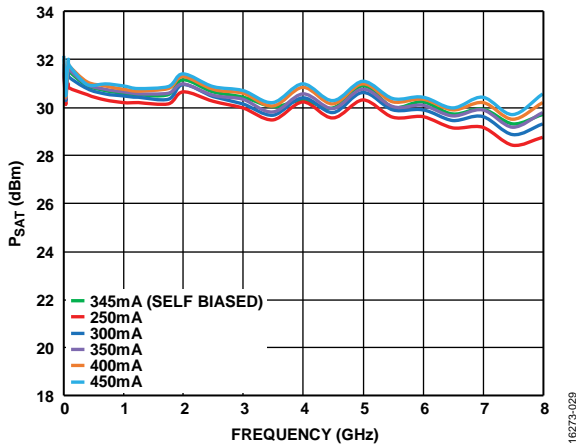

Figure 29. P_{SAT} vs. Frequency for Various Supply Currents (I_{DD}), $V_{DD} = 12\text{ V}$, $V_{GG2} = \text{Open}$, Controlled V_{GG1}

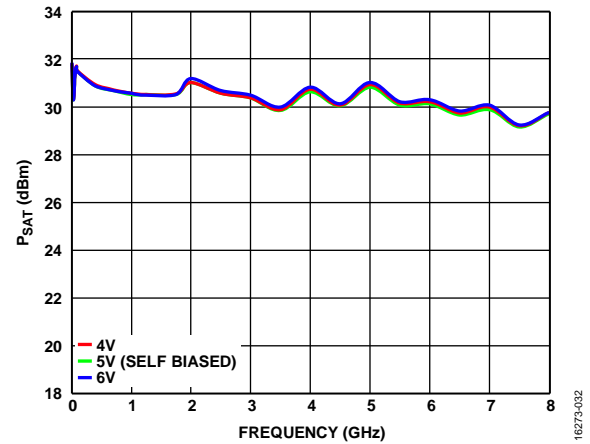

Figure 32. P_{SAT} vs. Frequency for Various V_{GG2} Values, $V_{DD} = 12\text{ V}$, $V_{GG1} = \text{GND}$

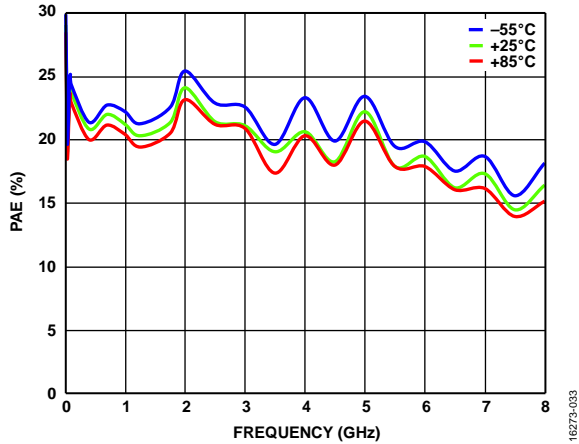

Figure 33. Power Added Efficiency (PAE) vs. Frequency for Various Temperatures, Self Biased Mode, $V_{DD} = 12\text{ V}$, $V_{GG2} = \text{Open}$, $V_{GG1} = \text{GND}$, PAE Measured at P_{SAT}

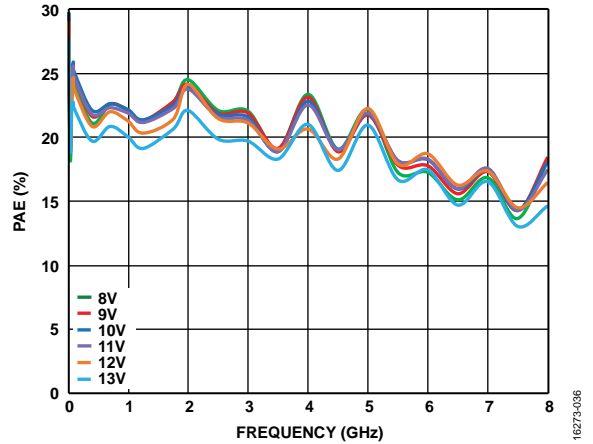

Figure 36. PAE vs. Frequency for Various Supply Voltages (V_{DD}), $V_{GG2} = \text{Open}$, $V_{GG1} = \text{GND}$, PAE Measured at P_{SAT}

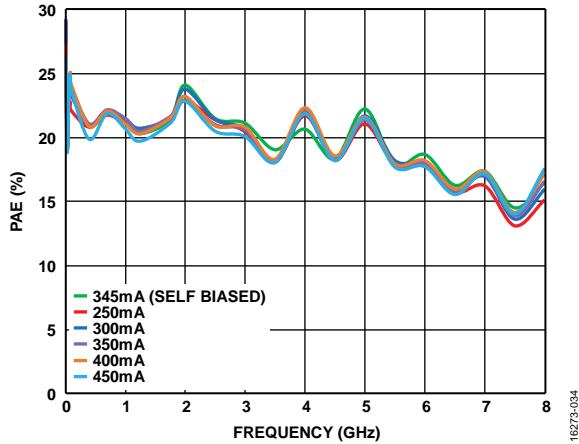

Figure 34. PAE vs. Frequency for Various Supply Currents (I_{DD}), $V_{DD} = 12\text{ V}$, $V_{GG2} = \text{Open}$, Controlled V_{GG1} , PAE Measured at P_{SAT}

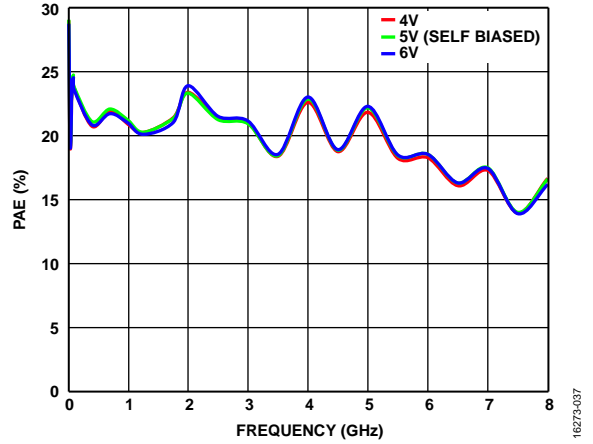

Figure 37. PAE vs. Frequency for Various V_{GG2} Values, $V_{DD} = 12\text{ V}$, $V_{GG1} = \text{GND}$, PAE Measured at P_{SAT}

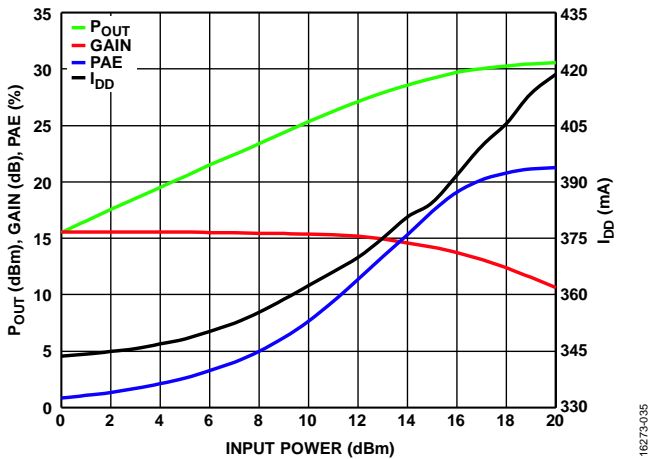

Figure 35. P_{OUT} , Gain, PAE, and I_{DD} vs. Input Power, 1 GHz, $V_{DD} = 12\text{ V}$, $V_{GG1} = \text{GND}$, $V_{GG2} = \text{Open}$

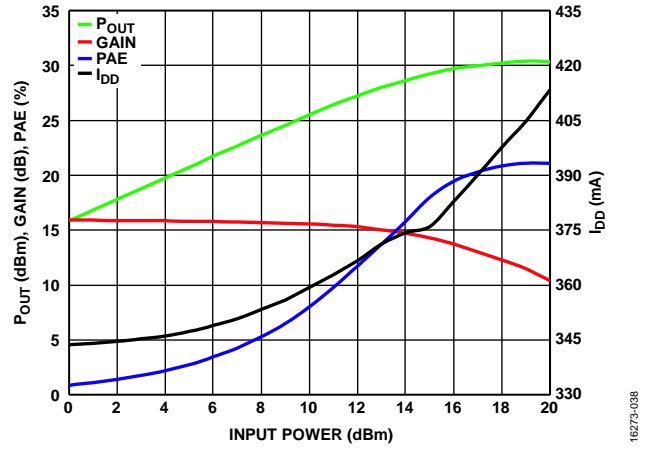

Figure 38. P_{OUT} , Gain, PAE, and I_{DD} vs. Input Power, 3 GHz, $V_{DD} = 12\text{ V}$, $V_{GG1} = \text{GND}$, $V_{GG2} = \text{Open}$

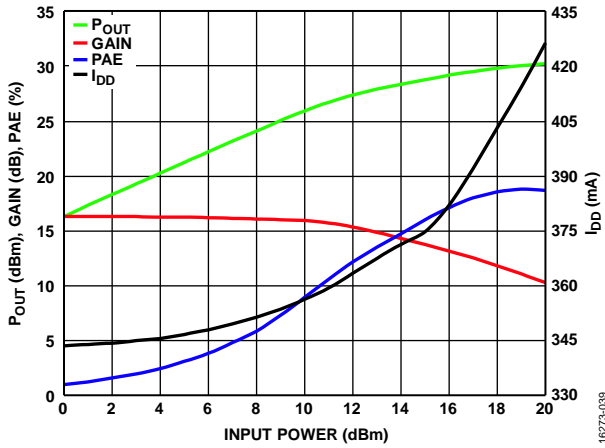

Figure 39. P_{OUT} , Gain, PAE, and I_{DD} vs. Input Power, 6 GHz, $V_{DD} = 12\text{ V}$, $V_{GG1} = \text{GND}$, $V_{GG2} = \text{Open}$

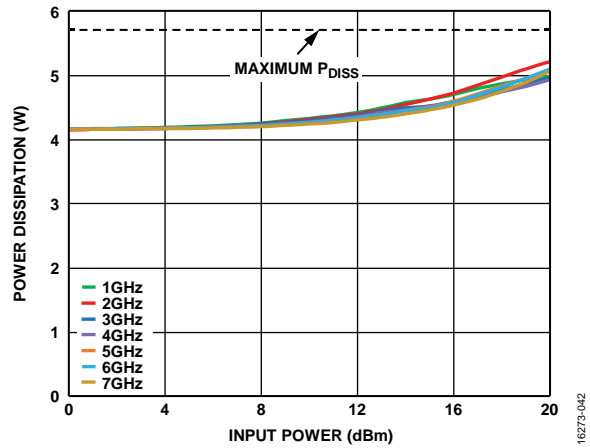

Figure 42. Power Dissipation vs. Input Power at $T_A = 85^\circ\text{C}$, $V_{DD} = 12\text{ V}$, $V_{GG1} = \text{GND}$, $V_{GG2} = \text{Open}$

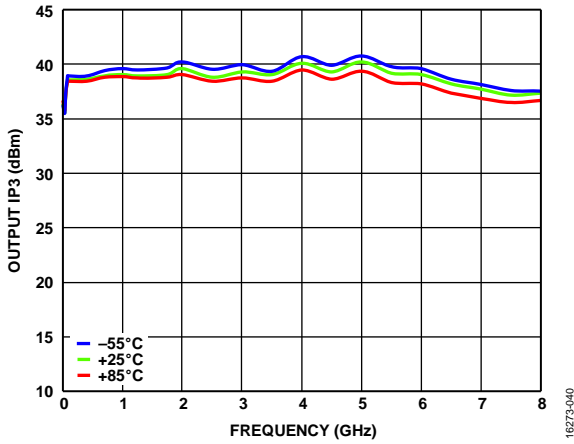

Figure 40. Output IP3 vs. Frequency for Various Temperatures, $P_{OUT}/\text{Tone} = 10\text{ dBm}$, Self Biased Mode, $V_{DD} = 12\text{ V}$, $V_{GG2} = \text{Open}$, $V_{GG1} = \text{GND}$

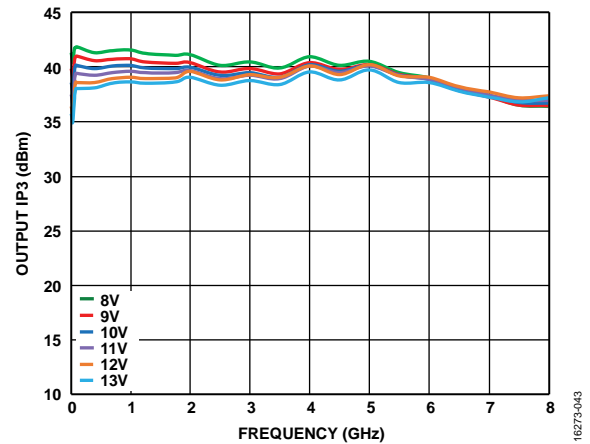

Figure 43. Output IP3 vs. Frequency for Various Supply Voltages (V_{DD}), $V_{GG2} = \text{Open}$, $V_{GG1} = \text{GND}$, $P_{OUT}/\text{Tone} = 10\text{ dBm}$

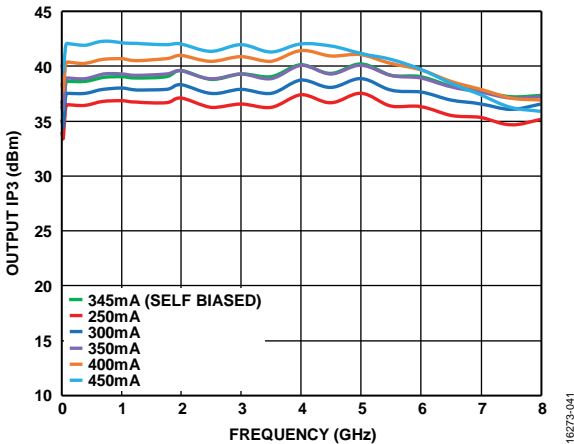

Figure 41. Output IP3 vs. Frequency for Various Supply Current (I_{DD}), $V_{DD} = 12\text{ V}$, $V_{GG2} = \text{Open}$, Controlled V_{GG1} , $P_{OUT}/\text{Tone} = 10\text{ dBm}$

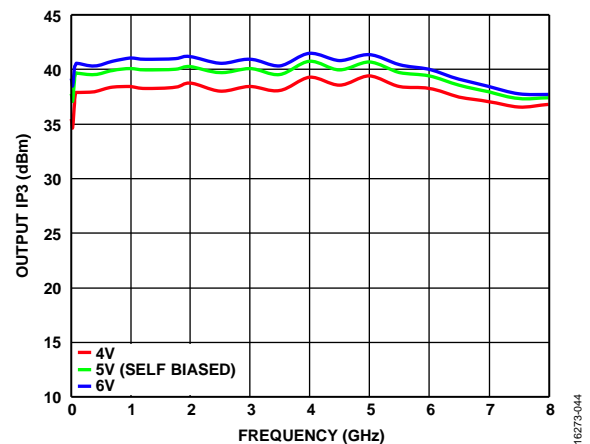

Figure 44. Output IP3 vs. Frequency for Various V_{GG2} Values, $V_{DD} = 12\text{ V}$, $V_{GG1} = \text{GND}$, $P_{OUT}/\text{Tone} = 10\text{ dBm}$

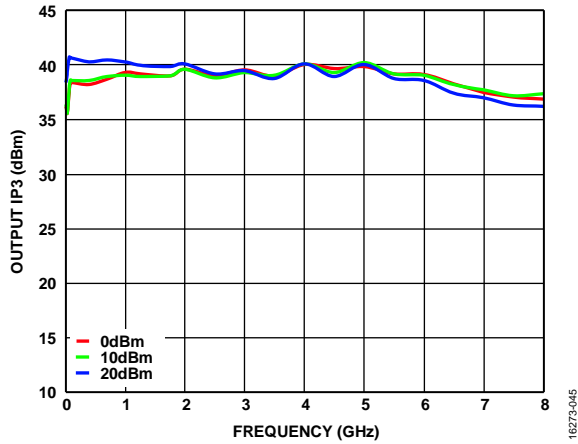

Figure 45. Output IP3 vs. Frequency for Various $P_{OUT}/Tone$, $V_{DD} = 12 V$, $V_{GG2} = Open$, $V_{GG1} = GND$

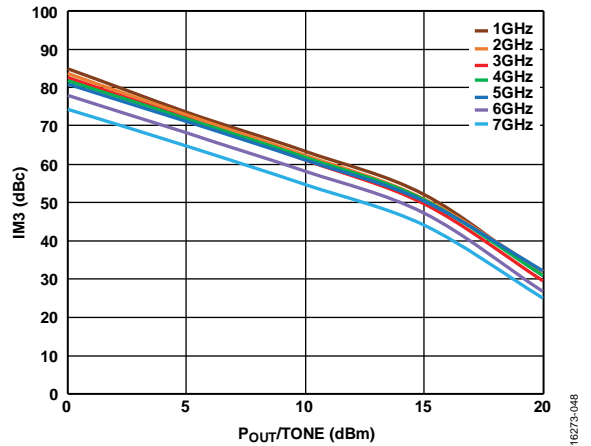

Figure 48. IM3 vs. $P_{OUT}/Tone$, $V_{DD} = 8 V$, $V_{GG2} = Open$, $V_{GG1} = GND$

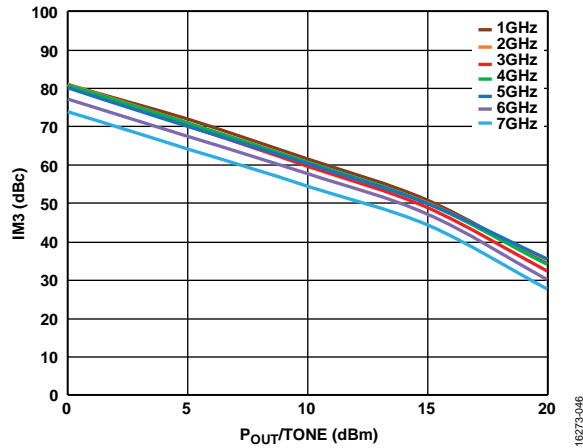

Figure 46. Third-Order Intermodulation Distortion Relative to Carrier (IM3) vs. $P_{OUT}/Tone$, $V_{DD} = 9 V$, $V_{GG2} = Open$, $V_{GG1} = GND$

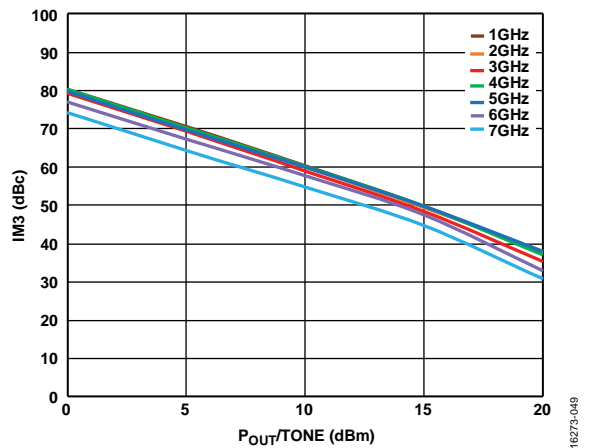

Figure 49. IM3 vs. $P_{OUT}/Tone$, $V_{DD} = 10 V$, $V_{GG2} = Open$, $V_{GG1} = GND$

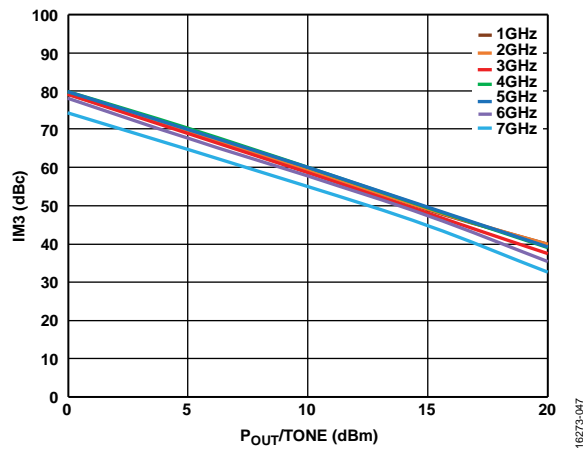

Figure 47. IM3 vs. $P_{OUT}/Tone$, $V_{DD} = 11 V$, $V_{GG2} = Open$, $V_{GG1} = GND$

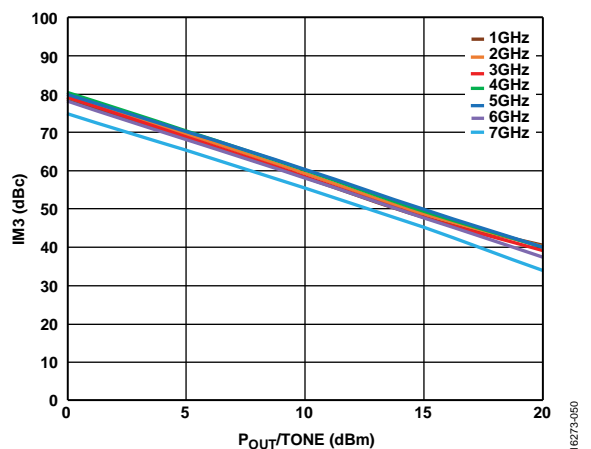

Figure 50. IM3 vs. $P_{OUT}/Tone$, $V_{DD} = 12 V$, $V_{GG2} = Open$, $V_{GG1} = GND$

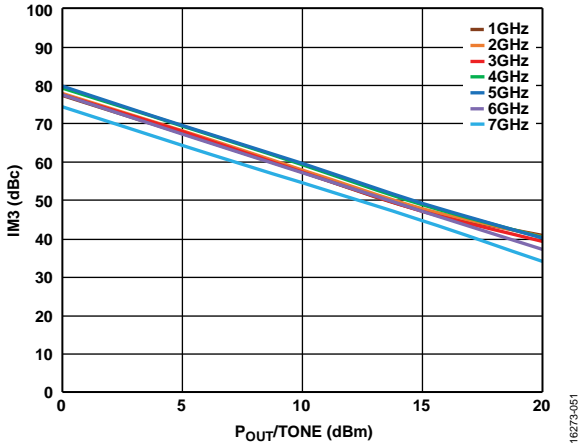

Figure 51. IM3 vs. $P_{OUT}/Tone$, $V_{DD} = 13\text{ V}$, $V_{GG2} = \text{Open}$, $V_{GG1} = \text{GND}$

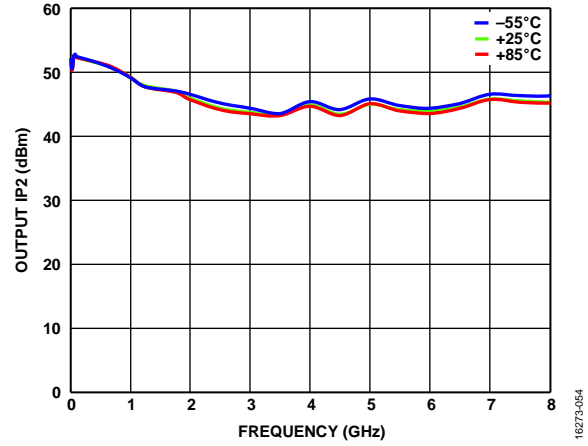

Figure 54. Output IP2 vs. Frequency for Various Temperatures, $P_{OUT}/Tone = 10\text{ dBm}$, $V_{DD} = 12\text{ V}$, $V_{GG2} = \text{Open}$, $V_{GG1} = \text{GND}$ (Self Biased)

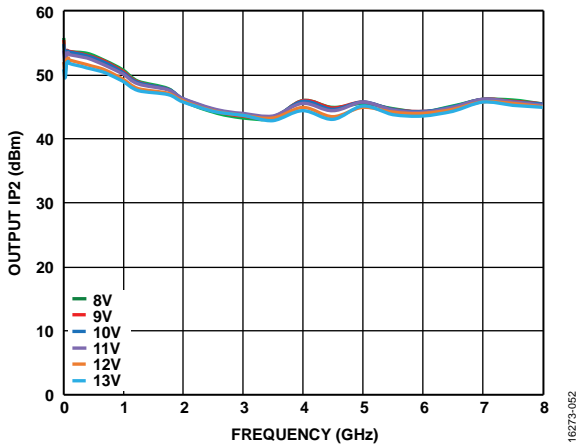

Figure 52. Output IP2 vs. Frequency for Various Supply Voltages (V_{DD}), $V_{GG2} = \text{Open}$, $V_{GG1} = \text{GND}$, $P_{OUT}/Tone = 10\text{ dBm}$

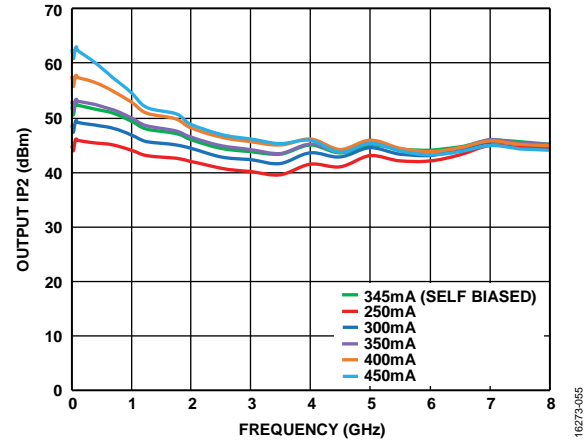

Figure 55. Output IP2 vs. Frequency for Various Supply Currents (I_{DD}), $V_{DD} = 12\text{ V}$, $V_{GG2} = \text{Open}$, Controlled V_{GG1} , $P_{OUT}/Tone = 10\text{ dBm}$

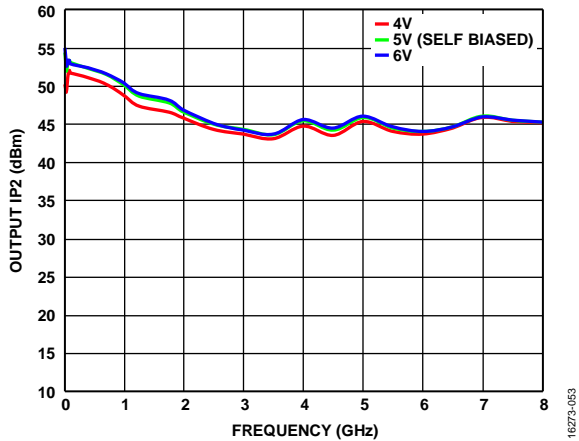

Figure 53. Output IP2 vs. Frequency for Various V_{GG2} Values, $V_{DD} = 12\text{ V}$, $V_{GG1} = \text{GND}$, $P_{OUT}/Tone = 10\text{ dBm}$

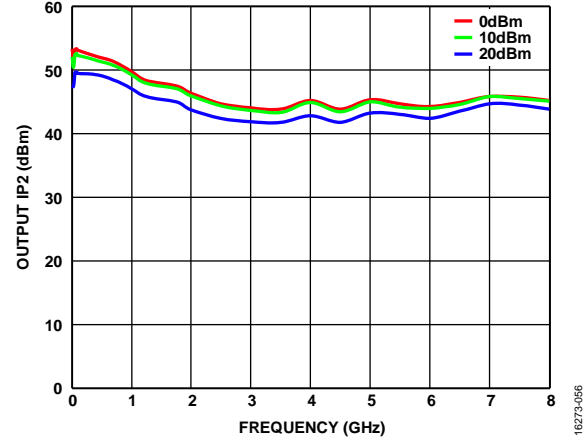

Figure 56. Output IP2 vs. Frequency for Various $P_{OUT}/Tone$ Values, $V_{DD} = 12\text{ V}$, $V_{GG2} = \text{Open}$, $V_{GG1} = \text{GND}$

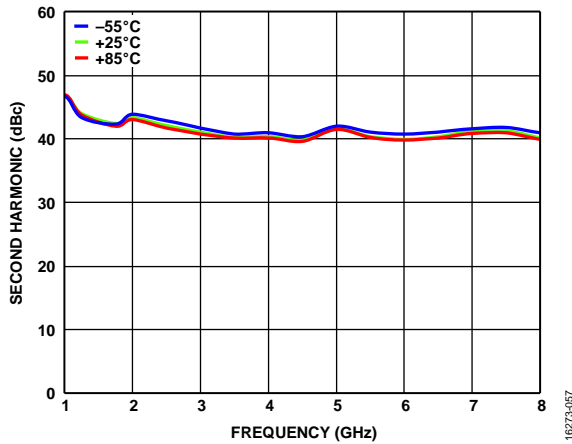

Figure 57. Second Harmonic vs. Frequency for Various Temperatures, $P_{OUT} = 10 \text{ dBm}$, $V_{DD} = 12 \text{ V}$, $V_{GG2} = \text{Open}$, $V_{GG1} = \text{GND (Self Biased)}$

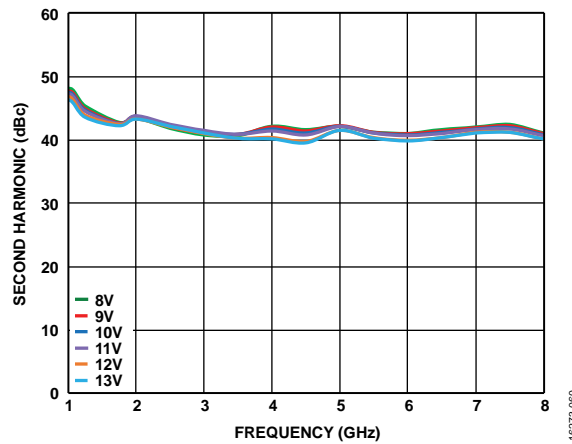

Figure 60. Second Harmonic vs. Frequency for Various Supply Voltages (V_{DD}), $P_{OUT} = 10 \text{ dBm}$, $V_{GG2} = \text{Open}$, $V_{GG1} = \text{GND}$

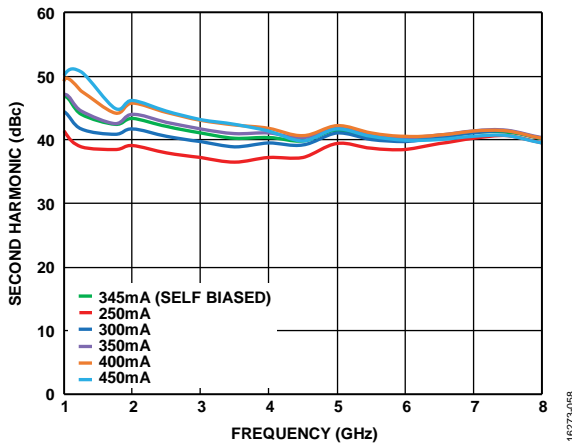

Figure 58. Second Harmonic vs. Frequency for Various Supply Currents (I_{DD}), $V_{DD} = 12 \text{ V}$, $V_{GG2} = \text{Open}$, Controlled V_{GG1} , $P_{OUT} = 10 \text{ dBm}$

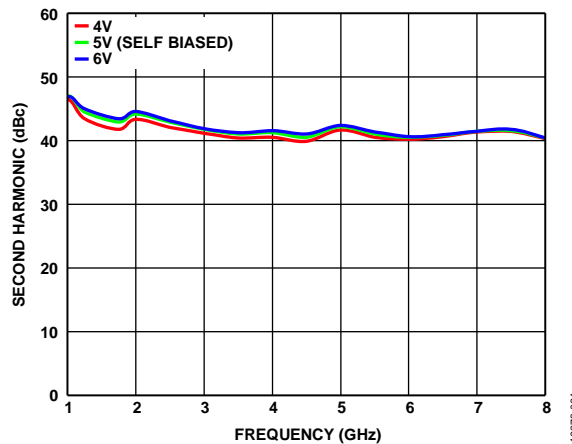

Figure 61. Second Harmonic vs. Frequency for Various V_{GG2} Values, $V_{DD} = 12 \text{ V}$, $V_{GG1} = \text{GND}$, $P_{OUT} = 10 \text{ dBm}$

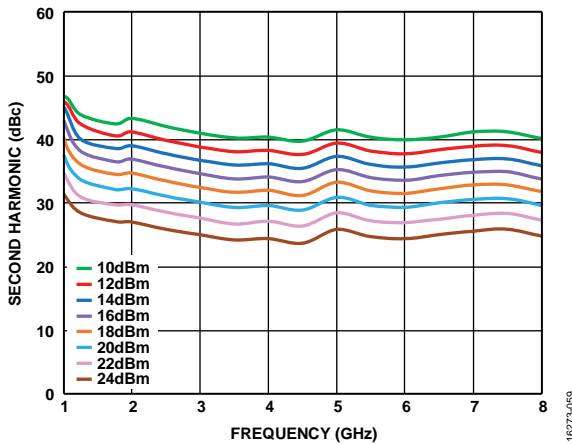

Figure 59. Second Harmonic vs. Frequency for Various P_{OUT} Values, $V_{DD} = 12 \text{ V}$, $V_{GG2} = \text{Open}$, $V_{GG1} = \text{GND (Self Biased)}$

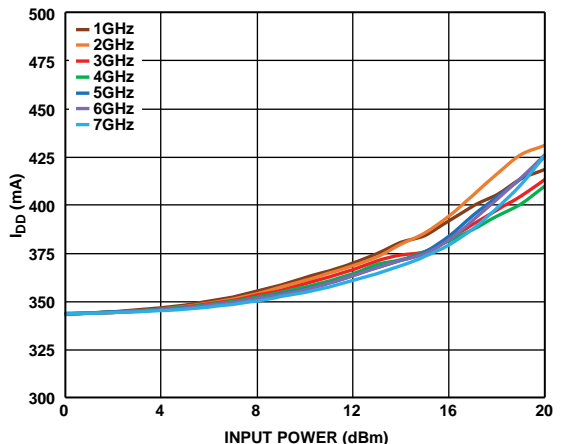

Figure 62. I_{DD} vs. Input Power for Various Frequencies, $V_{DD} = 12 \text{ V}$, $V_{GG2} = \text{Open}$, $V_{GG1} = \text{GND}$

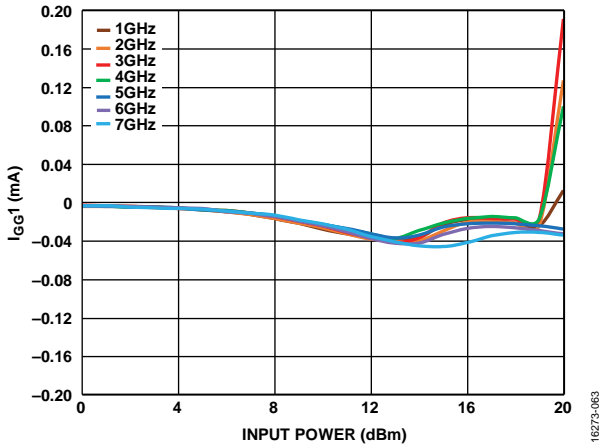

Figure 63. Gate 1 Current (I_{GG1}) vs. Input Power for Various Frequencies, $V_{DD} = 12\text{ V}$, $V_{GG2} = \text{Open}$, $V_{GG1} = \text{GND}$

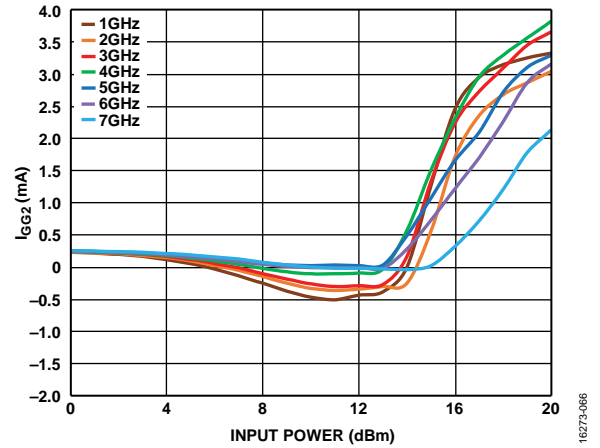

Figure 66. Gate 2 Current (I_{GG2}) vs. Input Power for Various Frequencies, $V_{DD} = 12\text{ V}$, $V_{GG2} = 5\text{ V}$, $V_{GG1} = \text{GND}$

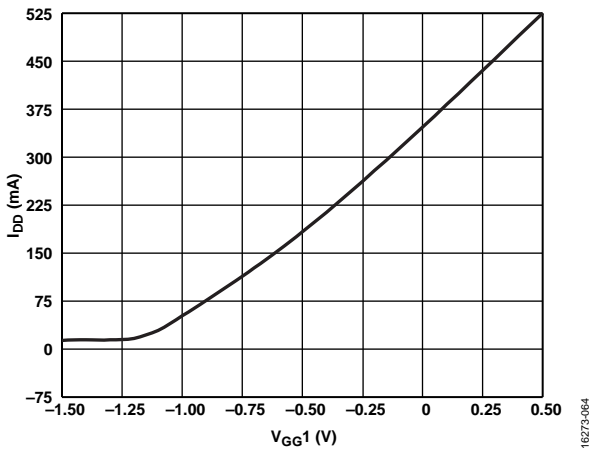

Figure 64. I_{DD} vs. V_{GG1} , $V_{DD} = 12\text{ V}$, $V_{GG2} = \text{Open}$

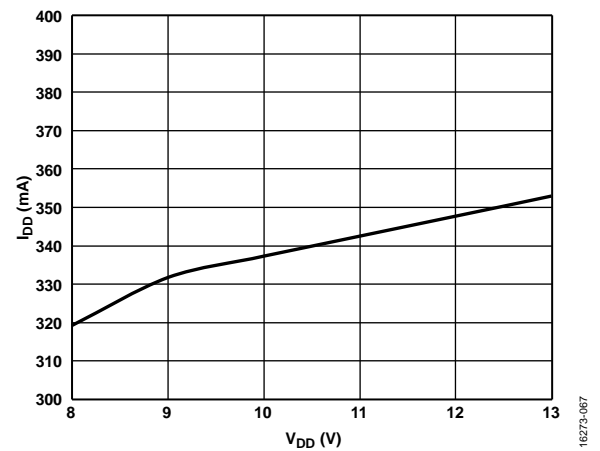

Figure 67. I_{DD} vs. V_{DD} , $V_{GG2} = \text{Open}$, $V_{GG1} = \text{GND}$

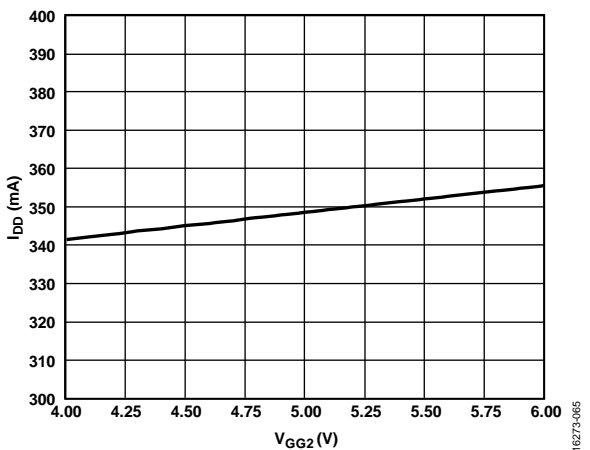

Figure 65. I_{DD} vs. V_{GG2} , $V_{DD} = 12\text{ V}$, $V_{GG1} = \text{GND}$

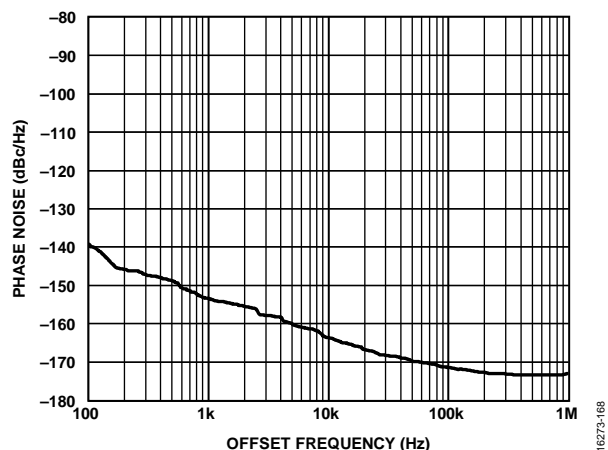

Figure 68. Additive Phase Noise vs. Offset Frequency, RF Frequency = 6 GHz, RF Input Power = 1 dBm (P1dB)

APPLICATIONS INFORMATION

Capacitive bypassing is required for V_{DD} and V_{GG1} , as shown in the typical application circuit in Figure 70. Both the RFIN and RFOUT/ V_{DD} pins are dc-coupled. Use of an external dc blocking capacitor at RFIN is recommended. Use of an external RF choke plus a dc blocking capacitor (for example, a bias tee) at RFOUT/

V_{DD} is required. For wideband applications, ensure that the frequency responses of the external biasing and blocking components are adequate for use across the entire frequency range of the application.

The HMC637BPM5E operates in either self biased or externally biased mode. To operate in self biased mode, ground the V_{GG1} pin and leave V_{GG2} open. For the externally biased configuration, adjust V_{GG1} within -2 V to $+0.5$ V to set the target drain current and adjust V_{GG2} from 4 V to 6 V for IP2 and IP3 control.

The recommended bias sequence during power-up for self biased operation is as follows:

1. Connect GND.
2. Set V_{DD} to 12 V.
3. Apply the RF signal.

The recommended bias sequence during power-down for self biased operation is as follows :

1. Turn off the RFIN signal.
2. Set V_{DD} to 0 V.

The recommended bias sequence during power-up for externally biased operation is as follows:

1. Connect GND.
2. Set V_{GG1} to -2 V.
3. Set V_{DD} to 12 V.
4. Increase V_{GG1} to achieve the desired quiescent current (I_{DQ}).
5. Apply the RF signal.
6. When using the IP2/IP3 control function, apply a voltage from 4 V to 6 V until the desired performance is obtained.

The recommended bias sequence during power-down for externally biased operation is as follows:

1. Turn off the RFIN signal.
2. Remove the V_{GG2} voltage.
3. Decrease V_{GG1} to -2 V to achieve a typical I_{DQ} of 0 mA.
4. Set V_{DD} to 0 V.
5. Set V_{GG1} to 0 V.

Adhere to the values shown in the Absolute Maximum Ratings section.

Unless otherwise noted, all measurements and data shown were taken using the typical application circuit (see Figure 70), and biased per the conditions in this section. The bias conditions described in this section are the operating points recommended to optimize the overall device performance. Operation using other bias conditions may result in performance that differs from what is shown in the Typical Performance Characteristic section. To obtain the best performance while avoiding damage to the device, follow the recommended biasing sequences described in this section.

TYPICAL APPLICATION CIRCUIT

In Figure 70, the drain bias (V_{DD}) must be applied through an external broadband bias tee connected at RFOUT/ V_{DD} and

connected to an external dc block at RFIN. Optional capacitors can be used if the device is to be operated below 200 MHz.

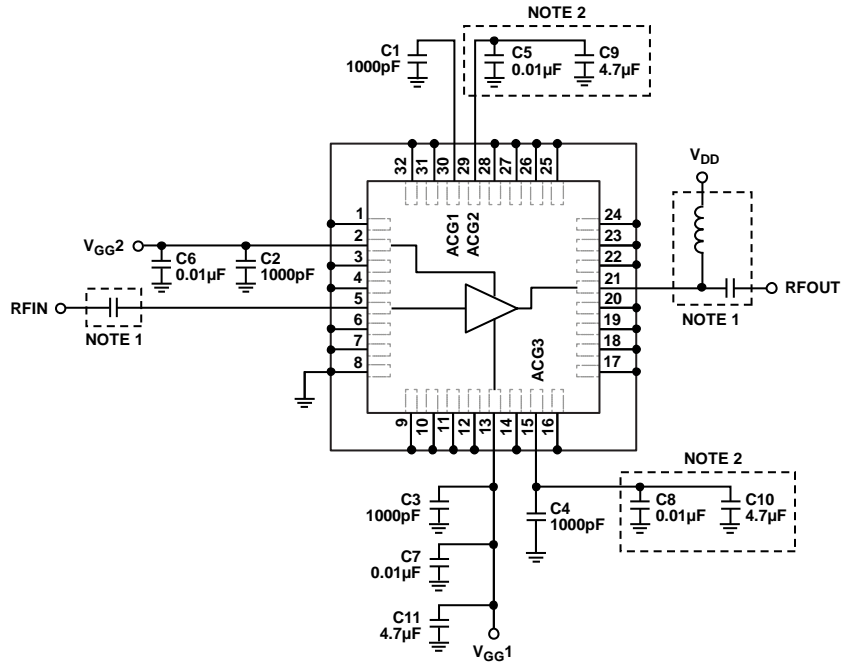

NOTES

1. DRAIN BIAS (V_{DD}) MUST BE APPLIED THROUGH AN ETERNAL BIAS TEE CONNECTED AT THE RFOUT/ V_{DD} PIN AND AN EXTERNAL DC BLOCK MUST BE CONNECTED AT THE RFIN PIN.
2. OPTIONAL CAPACITORS MUST BE USED IF THE DEVICE IS OPERATED BELOW 200MHZ.

Figure 70. Typical Application Circuit

16273-068

EVALUATION PCB

The EV1HMC637BPM5 (600-01711-00) evaluation PCB is shown in Figure 71.

BILL OF MATERIALS

Use RF circuit design techniques for the circuit board used in the application. Provide 50 Ω impedance for the signal lines and directly connect the package ground leads and exposed pad

to the ground plane, similar to what is shown in Figure 71. Use a sufficient number of via holes to connect the top and bottom ground planes, including the grounds directly beneath the ground pad to provide adequate electrical and thermal conduction. Use of a heat sink on the bottom side of the PCB is recommended. The evaluation PCB shown in Figure 71 is available from Analog Devices, Inc., upon request.

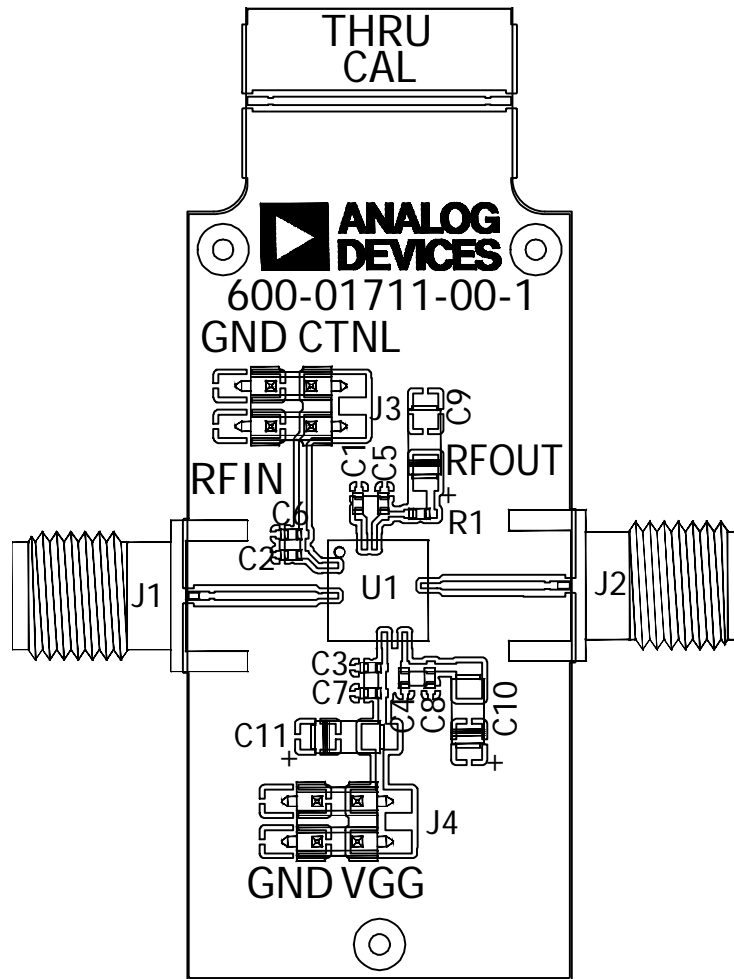

Figure 71. Evaluation PCB

Table 5. Bill of Materials for the Evaluation PCB EV1HMC637BPM5 (600-01711-00)

Item	Description
J1, J2	PCB Mount K connectors
J3, J4	DC pins
C1, C2, C3, C4	1000 pF capacitors, 0402 package
C5, C6, C7, C8	10000 pF capacitors, 0402 package
C9, C10, C11	4.7 μF capacitors, tantalum, 1206 package
R1	0 Ω resistor, 0402 package
U1	HMC637BPM5E
PCB	600-01711-00 evaluation PCB; circuit board material: Rogers 4350 or Arlon 25FR

OUTLINE DIMENSIONS

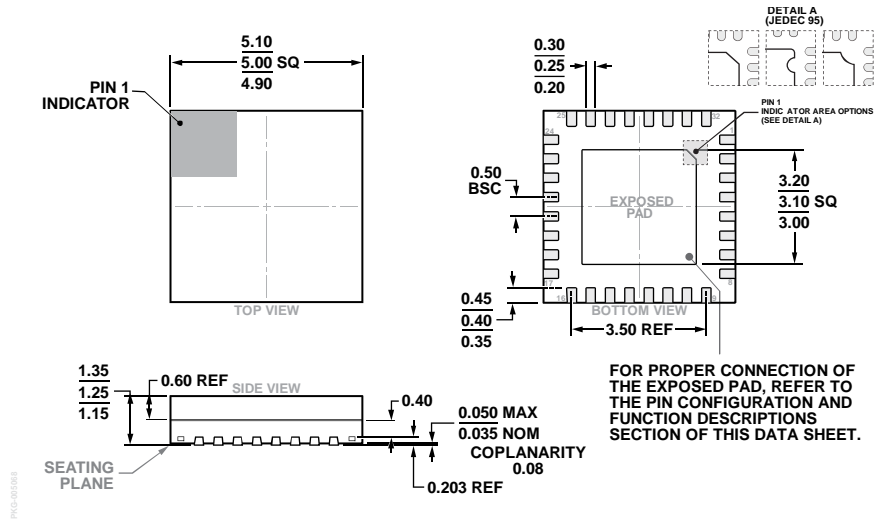

Figure 72. 32-Lead Lead Frame Chip Scale Package, Premolded Cavity [LFCSP_CAV]
 5 mm × 5 mm Body and 1.25 mm Package Height
 (CG-32-2)
 Dimensions shown in millimeter

ORDERING GUIDE

Model ^{1, 2}	Temperature	MSL Rating ³	Description ⁴	Package Option
HMC637BPM5E	-55°C to +85°C	3	32-Lead Lead Frame Chip Scale Package, Premolded Cavity [LFCSP_CAV]	CG-32-2
HMC637BPM5ETR	-55°C to +85°C	3	32-Lead Lead Frame Chip Scale Package, Premolded Cavity [LFCSP_CAV]	CG-32-2
EV1HMC637BPM5			Evaluation Board	

¹ All parts are RoHS Compliant.
² When ordering the evaluation board only, reference the model number, EV1HMC637BPM5.
³ See the Absolute Maximum Ratings section for additional information.
⁴ The lead finish of the HMC637BPM5E and the HMC637BPM5ETR is nickel palladium gold (NiPdAu).

X-ON Electronics

Largest Supplier of Electrical and Electronic Components

Click to view similar products for [RF Development Tools](#) category:

Click to view products by [Analog Devices](#) manufacturer:

Other Similar products are found below :

[MAAM-011117](#) [MAAP-015036-DIEEV2](#) [EV1HMC1113LP5](#) [EV1HMC6146BLC5A](#) [EV1HMC637ALP5](#) [EVAL-ADG919EBZ](#) [ADL5363-EVALZ](#) [LMV228SDEVAL](#) [SKYA21001-EVB](#) [SMP1331-085-EVB](#) [EV1HMC618ALP3](#) [EVAL01-HMC1041LC4](#) [MAAL-011111-000SMB](#)
[MAAM-009633-001SMB](#) [107712-HMC369LP3](#) [107780-HMC322ALP4](#) [SP000416870](#) [EV1HMC470ALP3](#) [EV1HMC520ALC4](#)
[EV1HMC244AG16](#) [MAX2614EVKIT#](#) [124694-HMC742ALP5](#) [SC20ASATEA-8GB-STD](#) [MAX2837EVKIT+](#) [MAX2612EVKIT#](#)
[MAX2692EVKIT#](#) [SKY12343-364LF-EVB](#) [108703-HMC452QS16G](#) [EV1HMC863ALC4](#) [EV1HMC427ALP3E](#) [119197-HMC658LP2](#)
[EV1HMC647ALP6](#) [ADL5725-EVALZ](#) [106815-HMC441LM1](#) [EV1HMC1018ALP4](#) [UXN14M9PE](#) [MAX2016EVKIT](#) [EV1HMC939ALP4](#)
[MAX2410EVKIT](#) [MAX2204EVKIT+](#) [EV1HMC8073LP3D](#) [SIMSA868-DKL](#) [SIMSA868C-DKL](#) [SKY65806-636EK1](#) [SKY68020-11EK1](#)
[SKY67159-396EK1](#) [SKY66181-11-EK1](#) [SKY65804-696EK1](#) [SKY13396-397LF-EVB](#) [SKY13380-350LF-EVB](#)