

GAAS PHEMT MMIC LOW NOISE AMPLIFIER, 4.8 - 6.0 GHz

Typical Applications

The HMC717ALP3E is ideal for:

- Fixed Wireless and LTE/WiMAX/4G
- BTS & Infrastructure
- Repeaters and Femtocells
- Public Safety Radio
- Access Points

Features

Noise Figure: 1.1 dB

Gain: 14.5 dB

Output IP3: +29.5 dBm

Single Supply: +3V to +5V

16 Lead 3x3mm QFN Package: 9 mm²

Functional Diagram

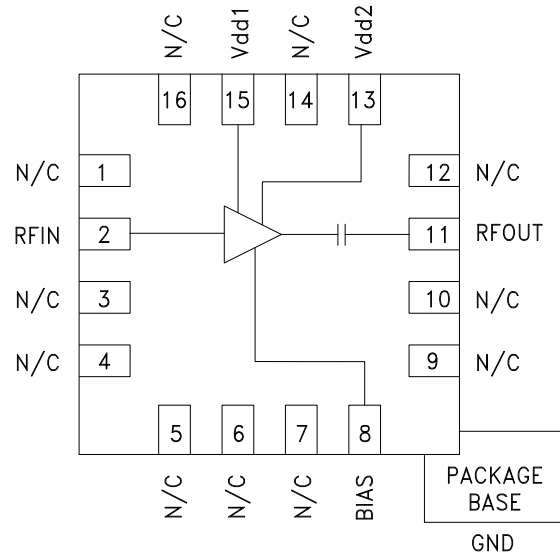

General Description

The HMC717ALP3E is a GaAs PHEMT MMIC Low Noise Amplifier that is ideal for fixed wireless and LTE/WiMAX/4G basestation front-end receivers operating between 4.8 and 6.0 GHz. The amplifier has been optimized to provide 1.1 dB noise figure, 14.5 dB gain and +29.5 dBm output IP3 from a single supply of +5V. Input and output return losses are excellent and the LNA requires minimal external matching and bias decoupling components. The HMC717ALP3E can be biased with +3V to +5V and features an externally adjustable supply current which allows the designer to tailor the linearity performance of the LNA for each application.

Electrical Specifications

$T_A = +25^\circ\text{C}$, $R_{bias} = 825\text{ Ohms}$ for $V_{dd} = 5V$, $R_{bias} = 5.76k\text{ Ohms}$ for $V_{dd} = 3V$ [1] [2]

| Parameter | Vdd = +3V | | | Vdd = +5V | | | Units |
|--|-----------|-------|------|-----------|------|------|-------|
| | Min. | Typ. | Max. | Min. | Typ. | Max. | |
| Frequency Range | 4.8 - 6.0 | | | 4.8 - 6.0 | | | GHz |
| Gain | | 12.5 | | 11.0 | 14.5 | | dB |
| Gain Variation Over Temperature | | 0.005 | | | 0.01 | | dB/°C |
| Noise Figure | | 1.3 | | | 1.3 | 1.8 | dB |
| Input Return Loss | | 8 | | | 9 | | dB |
| Output Return Loss | | 13 | | | 15 | | dB |
| Output Power for 1 dB Compression (P1dB) | | 12 | | | 18 | | dBm |
| Saturated Output Power (Psat) | | 14.5 | | | 19 | | dBm |
| Output Third Order Intercept (IP3) | | 23.5 | | | 29.5 | | dBm |
| Total Supply Current (Idd) | | 31 | | | 68 | 100 | mA |

[1] Rbias resistor sets current, see application circuit herein

[2] Vdd = Vdd1 = Vdd2

GAAS PHEMT MMIC LOW NOISE AMPLIFIER, 4.8 - 6.0 GHz

Broadband Gain & Return Loss [1][2]

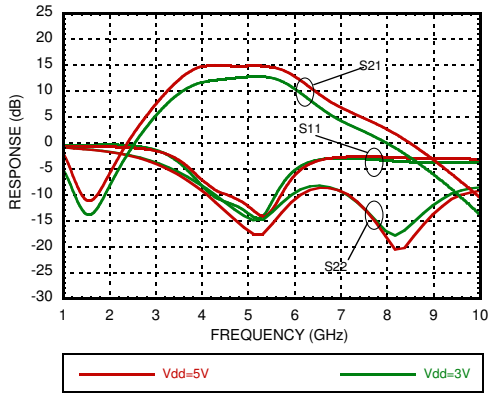

Gain vs. Temperature [1]

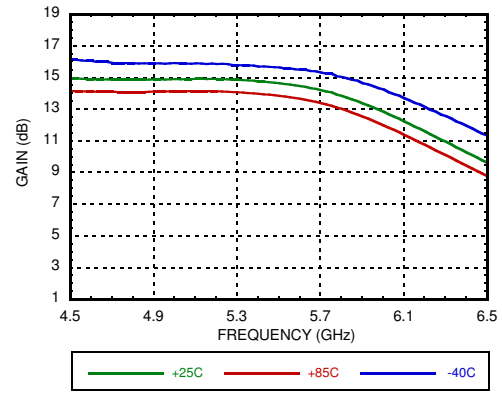

Gain vs. Temperature [2]

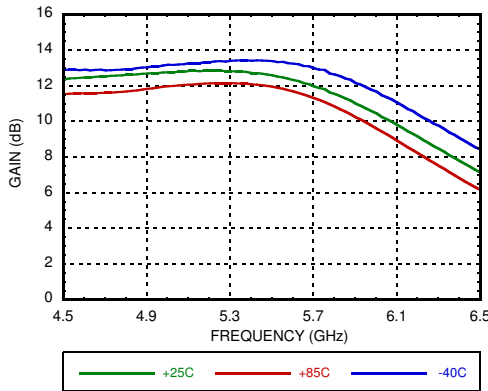

Input Return Loss vs. Temperature [1]

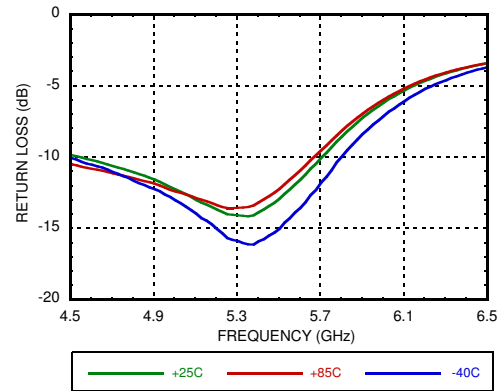

Output Return Loss vs. Temperature [1]

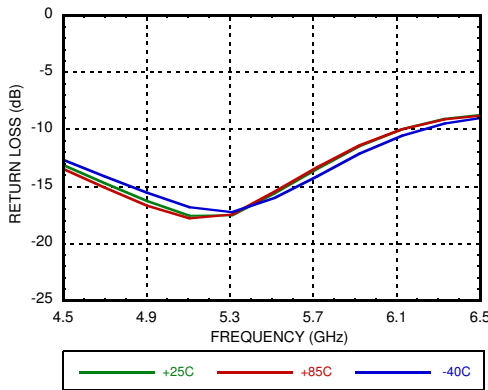

Reverse Isolation vs. Temperature [1]

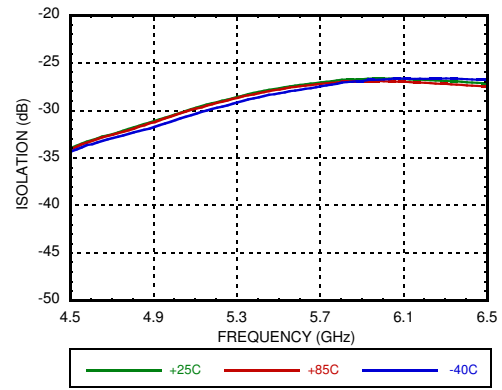

[1] Vdd = 5V, Rbias = 825Ω [2] Vdd = 3V, Rbias = 5.76kΩ

GAAS PHEMT MMIC LOW NOISE AMPLIFIER, 4.8 - 6.0 GHz

AMPLIFIER - LOW NOISE - SMT

Noise Figure vs. Temperature [1] [2]

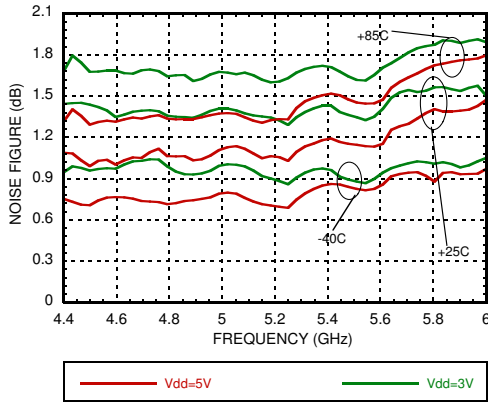

P1dB vs. Temperature [1] [2]

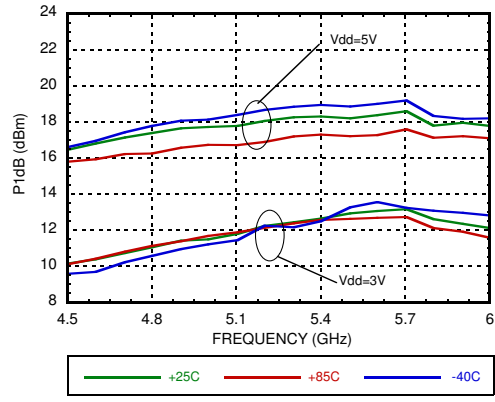

Psat vs. Temperature [1] [2]

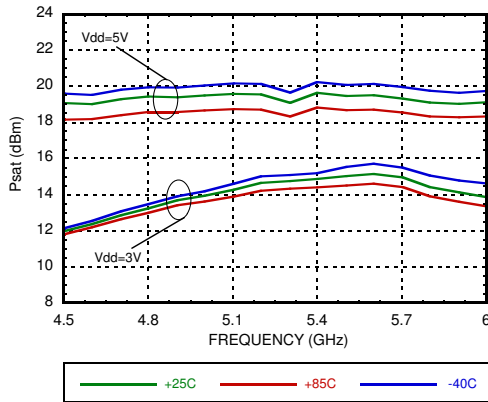

Output IP3 vs. Temperature [1] [2]

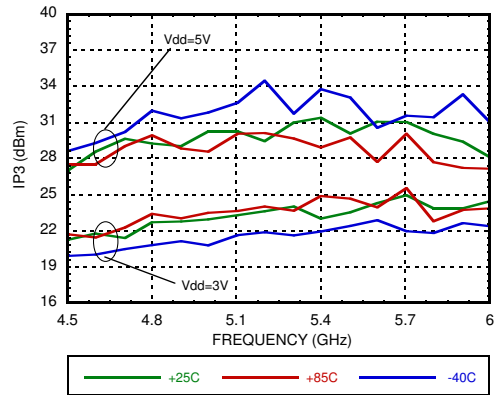

Output IP3 and Total Supply Current vs. Supply Voltage @ 4800 MHz [3]

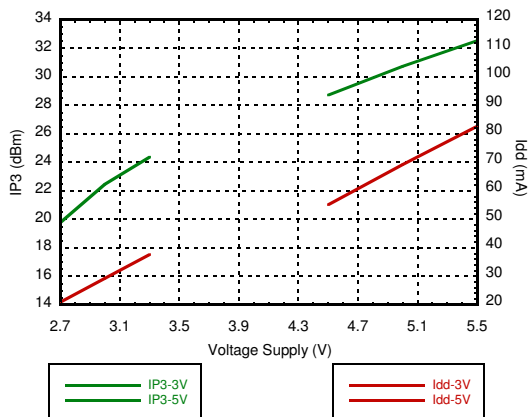

Output IP3 and Total Supply Current vs. Supply Voltage @ 5900 MHz [3]

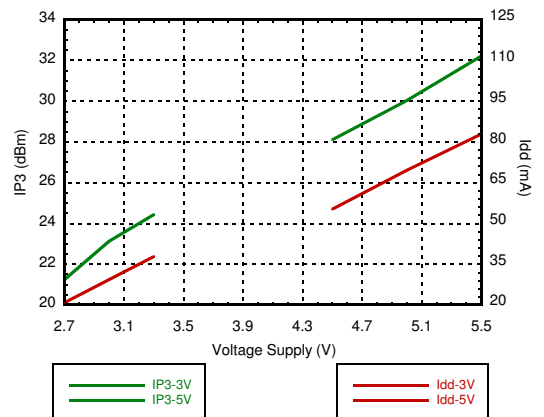

[1] Vdd = 5V, Rbias = 825Ω [2] Vdd = 3V, Rbias = 5.76kΩ
 [3] Rbias = 825Ω for Vdd = 5V, Rbias = 5.76kΩ for Vdd = 3V

GAAS PHEMT MMIC LOW NOISE AMPLIFIER, 4.8 - 6.0 GHz

Power Compression @ 4800 MHz [1]

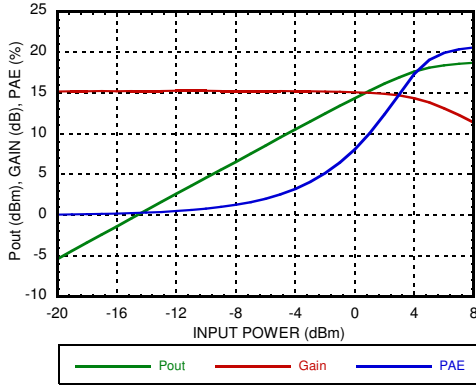

Power Compression @ 4800 MHz [2]

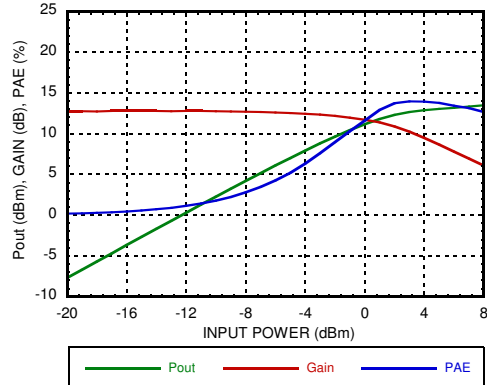

Power Compression @ 5900 MHz [1]

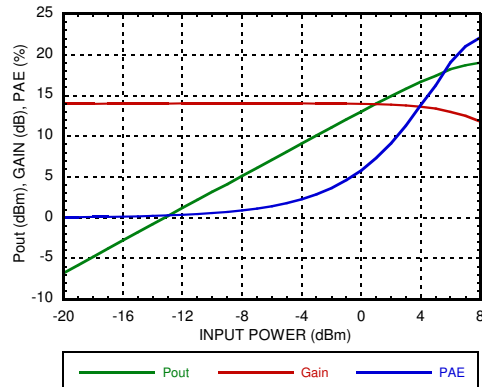

Power Compression @ 5900 MHz [2]

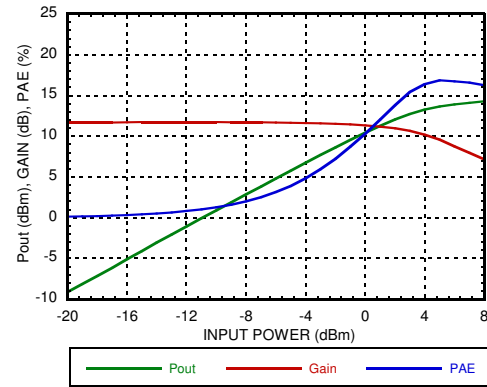

Gain, Power & Noise Figure vs. Supply Voltage @ 4800 MHz [3]

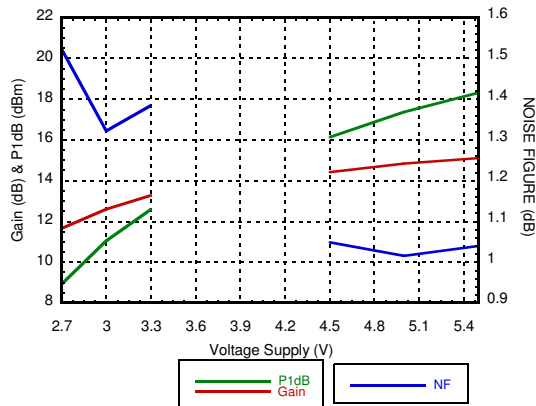

Gain, Power & Noise Figure vs. Supply Voltage @ 5900 MHz [3]

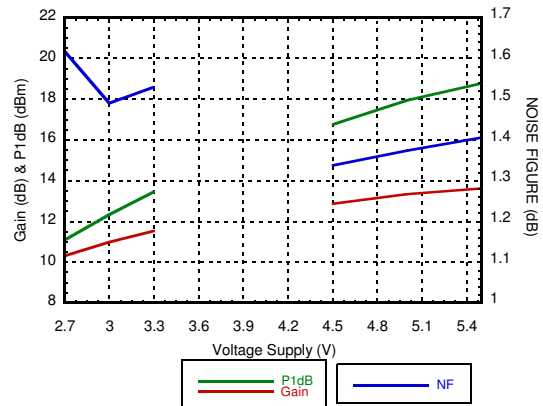

[1] Vdd = 5V, Rbias = 825Ω [2] Vdd = 3V, Rbias = 5.76kΩ [3] Rbias = 825Ω for Vdd = 5V, Rbias = 5.76kΩ for Vdd = 3V

GAAS PHEMT MMIC LOW NOISE AMPLIFIER, 4.8 - 6.0 GHz

Output IP3 vs. Rbias @ 4800 MHz

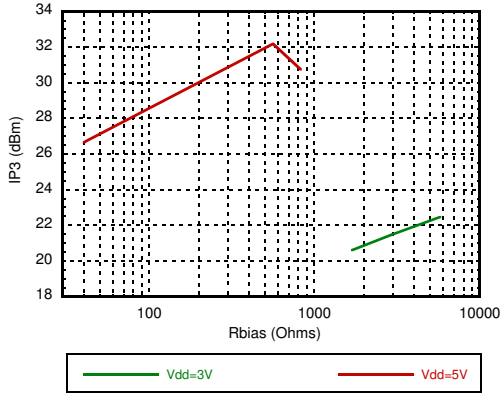

Gain, Noise Figure & Rbias @ 4800 MHz

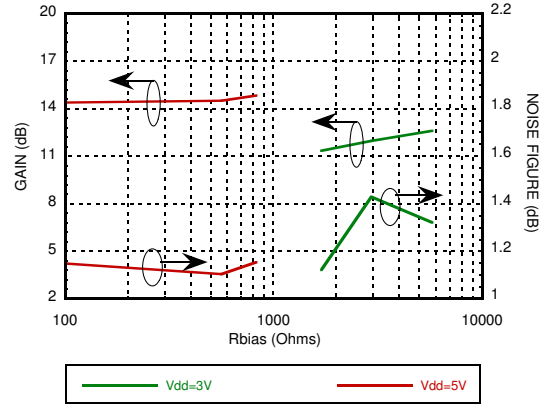

Output IP3 vs. Rbias @ 5900 MHz

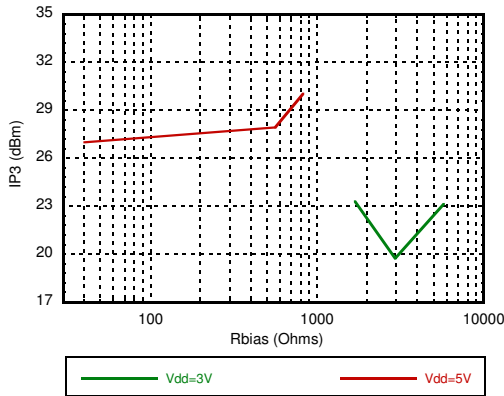

Gain, Noise Figure & Rbias @ 5900 MHz

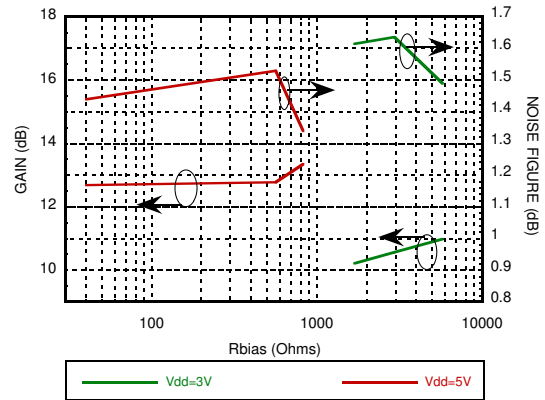

GAAS PHEMT MMIC LOW NOISE AMPLIFIER, 4.8 - 6.0 GHz

Absolute Bias Resistor Range & Recommended Bias Resistor Values

| Vdd (V) | Rbias (Ohms) | | | Idd (mA) |
|---------|----------------------|--------------|-------------|----------|
| | Min | Max | Recommended | |
| 3V | 1.69k ^[1] | Open Circuit | 1.69k | 20 |
| | | | 2.94k | 26 |
| | | | 5.76k | 30 |
| 5V | 40 ^[2] | Open Circuit | 40.2 | 48.4 |
| | | | 562 | 65.5 |
| | | | 825 | 72 |

[1] With Vdd= 3V and Rbias < 1.69kΩ may result in the part becoming conditionally stable which is not recommended.

[2] With Vdd = 5V and Rbias<40Ω may result in the part becoming conditionally stable which is not recommended.

Absolute Maximum Ratings

| | |
|---|----------------|
| Drain Bias Voltage (Vdd) | +5.5V |
| RF Input Power (RFIN) (Vdd = +5 Vdc) | +20 dBm |
| Channel Temperature | 150 °C |
| Continuous P _{diss} (T= 85 °C) (derate 8.0 mW/°C above 85 °C) | 0.52 W |
| Thermal Resistance (channel to ground paddle) | 125 °C/W |
| Storage Temperature | -65 to +150 °C |
| Operating Temperature | -40 to +85 °C |
| ESD Sensitivity (HBM) | Class 1A |



ELECTROSTATIC SENSITIVE DEVICE
OBSERVE HANDLING PRECAUTIONS

Typical Supply Current vs. Supply Voltage

| Rbias | Vdd (V) | Idd (mA) |
|-------|---------|----------|
| 5.76K | 2.7 | 20 |
| | 3.0 | 31 |
| | 3.3 | 39 |
| 825 | 4.5 | 57 |
| | 5.0 | 72 |
| | 5.5 | 86 |

Note: Amplifier will operate over full voltage ranges shown above.

**GAAS PHEMT MMIC LOW NOISE
AMPLIFIER, 4.8 - 6.0 GHz**

Outline Drawing

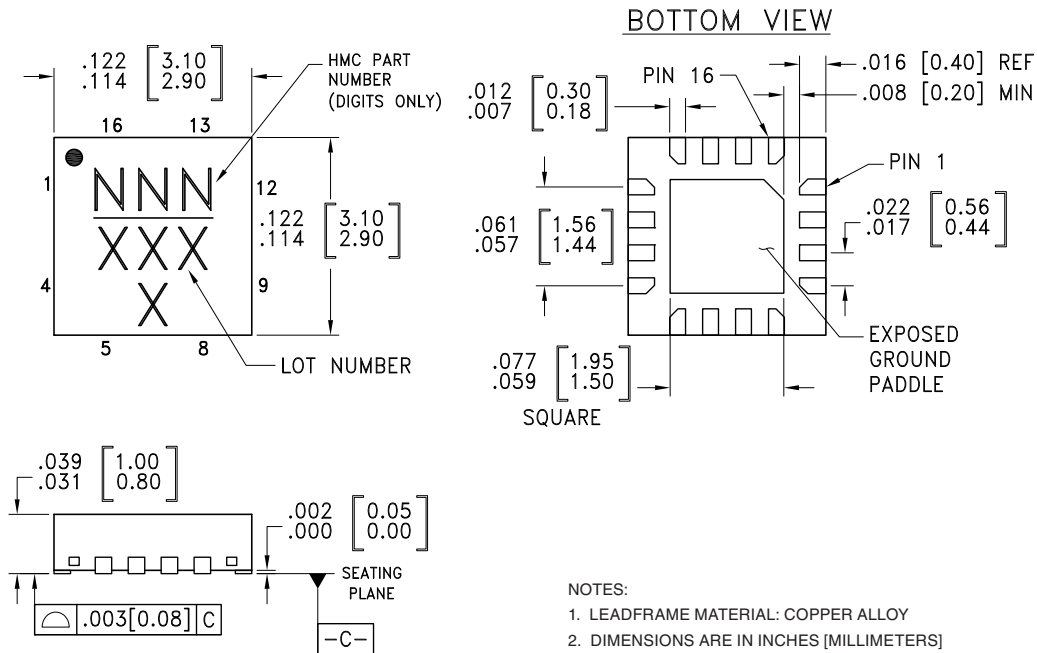

NOTES:

1. LEADFRAME MATERIAL: COPPER ALLOY
2. DIMENSIONS ARE IN INCHES [MILLIMETERS]
3. LEAD SPACING TOLERANCE IS NON-CUMULATIVE
4. PAD BURR LENGTH SHALL BE 0.15mm MAXIMUM.
PAD BURR HEIGHT SHALL BE 0.05mm MAXIMUM.
5. PACKAGE WARP SHALL NOT EXCEED 0.05mm.
6. ALL GROUND LEADS AND GROUND PADDLE
MUST BE SOLDERED TO PCB RF GROUND.
7. REFER TO HITTITE APPLICATION NOTE FOR
SUGGESTED LAND PATTERN.



Package Information

| Part Number | Package Body Material | Lead Finish | MSL Rating | Package Marking ^[3] |
|-------------|--|---------------|---------------------|--------------------------------|
| HMC717ALP3E | RoHS-compliant Low Stress Injection Molded Plastic | 100% matte Sn | MSL3 ^[2] | 717A XXXX |

[1] Max peak reflow temperature of 235 °C
 [2] Max peak reflow temperature of 260 °C
 [3] 4-Digit lot number XXXX

GAAS PHEMT MMIC LOW NOISE AMPLIFIER, 4.8 - 6.0 GHz

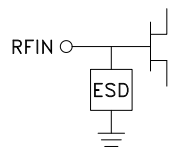
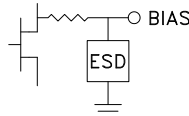
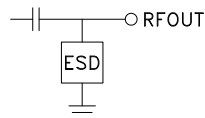
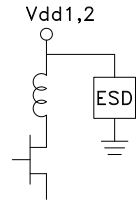
Pin Descriptions

| Pin Number | Function | Description | Interface Schematic |
|-----------------------------|------------|--|---|
| 1, 3 - 7, 9, 10, 12, 14, 16 | N/C | No connection required. These pins may be connected to RF/DC ground without affecting performance. | |
| 2 | RFIN | This pin is DC coupled See the application circuit for off-chip component. |  |
| 8 | BIAS | This pin is used to set the DC current of the amplifier by selection of the external bias resistor. See application circuit. |  |
| 11 | RFOUT | This pin is AC coupled and matched to 50 Ohms |  |
| 13, 15 | Vdd2, Vdd1 | Power supply voltage. Bypass capacitors are required. See application circuit. |  |
| | GND | Package bottom must be connected to RF/DC ground |  |

**GAAS PHEMT MMIC LOW NOISE
AMPLIFIER, 4.8 - 6.0 GHz**
THEORY OF OPERATION

The HMC717A is a gallium arsenide (GaAs), monolithic microwave integrated circuit (MMIC), pseudomorphic (pHEMT), low noise amplifier. The HMC717A amplifier uses two gain stages in series, the basic schematic for the amplifier is shown in Figure 3, which forms a low noise amplifier operating from 4.8 GHz to 6 GHz with excellent noise figure performance.

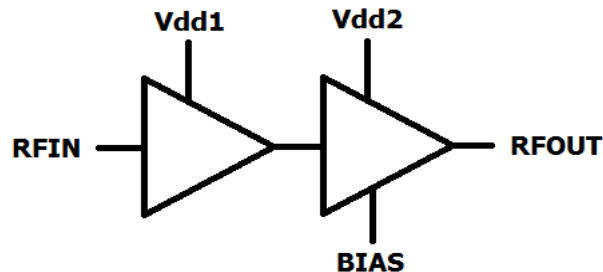

Basic Schematic for HMC717A

The HMC717A has single-ended input and output ports whose impedances are nominally equal to 50 Ω over the 4.8 GHz to 6 GHz frequency range. Consequently, it can directly insert into a 50 Ω system with no required impedance matching circuitry, which also means that multiple HMC717A amplifiers can be cascaded back to back without the need for external matching circuitry. The input and output impedances are sufficiently stable vs. variations in temperature and supply voltage that no impedance matching compensation is required. Note that it is critical to supply very low inductance ground connections to the backside exposed paddle to ensure stable operation. To achieve optimal performance from the HMC717A and prevent damage to the device, the absolute maximum ratings should not be exceeded.

APPLICATIONS INFORMATION

The figure above shows the basic connections for operating the HMC717A. AC couple the input with 1.2 pF capacitor. The RF output of the HMC717A has on chip DC block capacitor which eliminates the need for external AC coupling capacitor. Use the appropriate Rbias resistor values, given in the Absolute Bias Resistor Range & Recommended Bias Resistor Values table on page 6. The bias conditions previously listed (VDD = 5 V, Rbias = 825 Ω and VDD = 3 V, Rbias = 5.76k Ω) are the recommended operating points to achieve optimum performance. The data used in this data sheet was taken with the recommended bias conditions. When using the HMC717A with different bias conditions, different performance than what is shown in the Typical Performance Characteristics section may result. Increasing the Vdd level and changing the Rbias resistor to the recommended value, typically improves gain, IP3 and noise figure at the expense of power consumption. This behavior can be seen on Typical Performance Characteristics plots.

GAAS PHEMT MMIC LOW NOISE AMPLIFIER, 4.8 - 6.0 GHz

Application Circuit

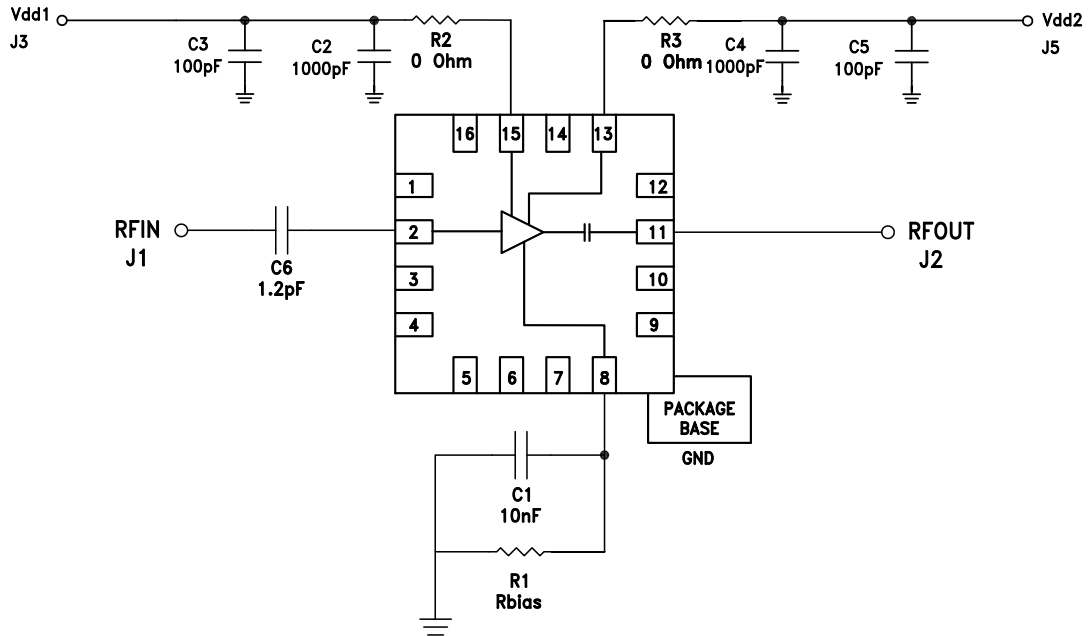

HMC717ALP3FE Evaluation Board Schematic

GAAS PHEMT MMIC LOW NOISE AMPLIFIER, 4.8 - 6.0 GHz

Evaluation PCB

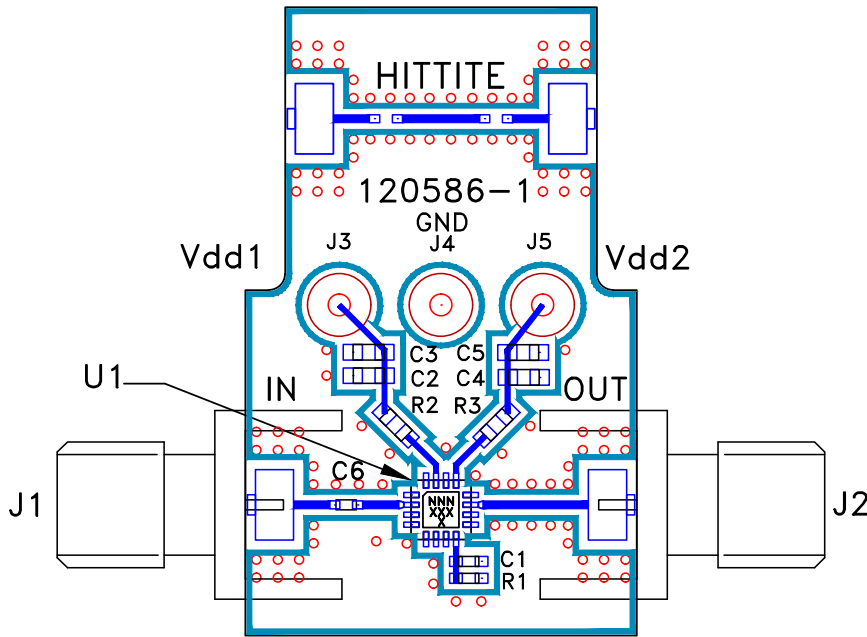

Evaluation Printed Circuit Board (PCB)

List of Materials for Evaluation PCB EV1HMC717ALP3 [1]

| Item | Description |
|---------|--|
| J1, J2 | PCB mount SMA RF connectors, Johnson 142-0701-851 |
| J3 - J5 | PCB mount SMA RF connectors, Johnson 142-0701-851 |
| C1 | Capacitor, ceramic, 10 nF, 16 V, X7R, 0402 package. |
| C2, C4 | Capacitor, ceramic, 1 nF, 50 V, X7R, 0603 package. |
| C3, C5 | Capacitor, ceramic, 0.1 μ F, 50 V, X7R, 0603 package. |
| C6 | Capacitor, ceramic, 1.2 pF, 25 V, COG, High Q, 0402 package. |
| R1 | Resistor, 825 Ohm 1%, 0402 Pkg. (Rbias) |
| R2, R3 | 0 Ohm Resistor, 0402 Pkg. |
| U1 | HMC717ALP3E Amplifier |
| PCB | 120586 evaluation PCB; circuit board material: Rogers 4350 |

[1] Reference this number when ordering complete evaluation PCB

The HMC717ALP3E evaluation board is a four-layer board fabricated using Rogers 4350 and using best practices for high frequency RF design. The RF input and RF output traces have a 50 Ω characteristic impedance.

The HMC717ALP3E evaluation board and populated components are designed to operate over the ambient temperature range of -40°C to $+85^{\circ}\text{C}$. For proper bias sequence, please see the Applications information section of the datasheet.

The HMC717ALP3E evaluation board schematic (HMC717ALP3FE Evaluation Board Schematic) is shown on page 10. A fully populated and tested evaluation board, shown above, is available from Analog Devices, Inc., upon request.

X-ON Electronics

Largest Supplier of Electrical and Electronic Components

Click to view similar products for [RF Development Tools](#) category:

Click to view products by [Analog Devices](#) manufacturer:

Other Similar products are found below :

[MAAM-011117](#) [MAAP-015036-DIEEV2](#) [EV1HMC1113LP5](#) [EV1HMC6146BLC5A](#) [EV1HMC637ALP5](#) [EVAL-ADG919EBZ](#) [ADL5363-EVALZ](#) [LMV228SDEVAL](#) [SKYA21001-EVB](#) [SMP1331-085-EVB](#) [EV1HMC618ALP3](#) [EVAL01-HMC1041LC4](#) [MAAL-011111-000SMB](#) [MAAM-009633-001SMB](#) [MASW-000936-001SMB](#) [107712-HMC369LP3](#) [107780-HMC322ALP4](#) [SP000416870](#) [EV1HMC470ALP3](#) [EV1HMC520ALC4](#) [EV1HMC244AG16](#) [MAX2614EVKIT#](#) [124694-HMC742ALP5](#) [SC20ASATEA-8GB-STD](#) [MAX2837EVKIT+](#) [MAX2612EVKIT#](#) [MAX2692EVKIT#](#) [EV1HMC629ALP4E](#) [SKY12343-364LF-EVB](#) [108703-HMC452QS16G](#) [EV1HMC863ALC4](#) [119197-HMC658LP2](#) [EV1HMC647ALP6](#) [ADL5725-EVALZ](#) [106815-HMC441LM1](#) [EV1HMC1018ALP4](#) [UXN14M9PE](#) [MAX2016EVKIT](#) [EV1HMC939ALP4](#) [MAX2410EVKIT](#) [MAX2204EVKIT+](#) [EV1HMC8073LP3D](#) [SIMSA868-DKL](#) [SIMSA868C-DKL](#) [SKY65806-636EK1](#) [SKY68020-11EK1](#) [SKY67159-396EK1](#) [SKY66181-11-EK1](#) [SKY65804-696EK1](#) [SKY13396-397LF-EVB](#)