

Evaluating the **ADF4355-2** Fractional-N/Integer-N PLL Frequency Synthesizer

FEATURES

Self contained board, including **ADF4355-2** frequency synthesizer with integrated VCO, differential 122.88 MHz temperature controlled crystal oscillator (TCXO), loop filter (20 kHz), USB interface, and voltage regulators
Windows®-based software allows control of synthesizer functions from a PC
Externally powered by 6 V

EVALUATION KIT CONTENTS

EV-ADF4355-2SD1Z
USB cable

EQUIPMENT NEEDED

Windows-based PC with USB port for evaluation software
System demonstration platform, serial only (**SDP-S**)
EVAL-SDP-CS1Z controller board
Power supply (6 V)
Spectrum analyzer
50 Ω terminators

ONLINE RESOURCES

Documents Needed

[ADF4355-2](#) data sheet
[EV-ADF4355-2SD1Z](#) user guide
[PLL Software Installation Guide](#)

Required Software

Analog Devices, Inc., [ADF4355-2](#) software, Version 0.46.1 or higher (available for download at www.analog.com/ADF4355-2)

GENERAL DESCRIPTION

The **EV-ADF4355-2SD1Z** evaluates the performance of the **ADF4355-2** frequency synthesizer with integrated VCO for phase-locked loops (PLLs). A photograph of the evaluation board is shown in Figure 1. The evaluation board contains the **ADF4355-2** frequency synthesizer with integrated VCO, a differential 122.88 MHz reference (TCXO), a loop filter, a USB interface, power supply connectors, and subminiature Version A (SMA) connectors. A USB cable is included to connect the board to a PC USB port.

For easy programming of the synthesizer, download the Windows-based software from www.analog.com/ADF4355-2.

This board requires an **SDP-S** (shown in Figure 1, but not supplied with the kit). The **SDP-S** allows software programming of the **EV-ADF4355-2SD1Z** device.

EVALUATION BOARD PHOTOGRAPH

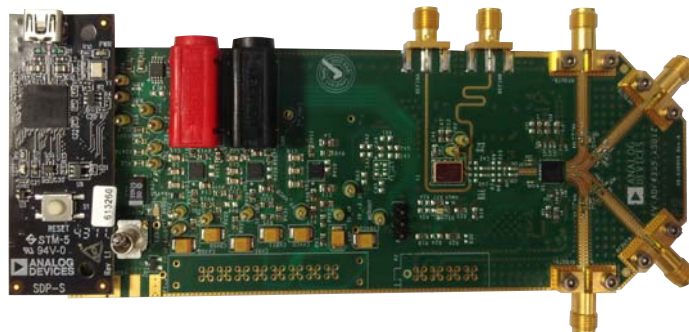

Figure 1. **EV-ADF4355-2SD1Z**

TABLE OF CONTENTS

Features	1	RF Output.....	4
Evaluation Kit Contents.....	1	Loop Filter.....	4
Equipment Needed.....	1	Reference Source	4
Online Resources.....	1	Default Configuration	4
General Description	1	Evaluation Board Setup	5
Evaluation Board Photograph.....	1	Evaluation Board Software.....	6
Revision History	2	Main Controls.....	6
Getting Started	3	Evaluation and Test	7
Software Installation Procedures.....	3	Evaluation Board Schematics and Artwork.....	8
Evaluation Board Setup Procedures.....	3	Ordering Information.....	17
Evaluation Board Hardware.....	4	Bill of Materials.....	17
Power Supplies	4		

REVISION HISTORY

5/15—Revision 0: Initial Version

GETTING STARTED

SOFTWARE INSTALLATION PROCEDURES

See the [ADF4355-2](#) product page for the [EV-ADF4355-2SD1Z](#) control software. For the software installation procedure, see the [PLL Software Installation Guide](#).

EVALUATION BOARD SETUP PROCEDURES

To run the software,

1. Click the **ADF4355-2** file on the desktop or from the **Start** menu.
2. On the **Select Device and Connection** tab, choose **ADF4355-2** and **SDP board (black)**, and then click **Connect** (see Figure 2).
3. When connecting the board, allow 5 sec to 10 sec for the label on the status bar to change.

Under the **File** menu, the current settings can be saved to, and loaded from, a text file.

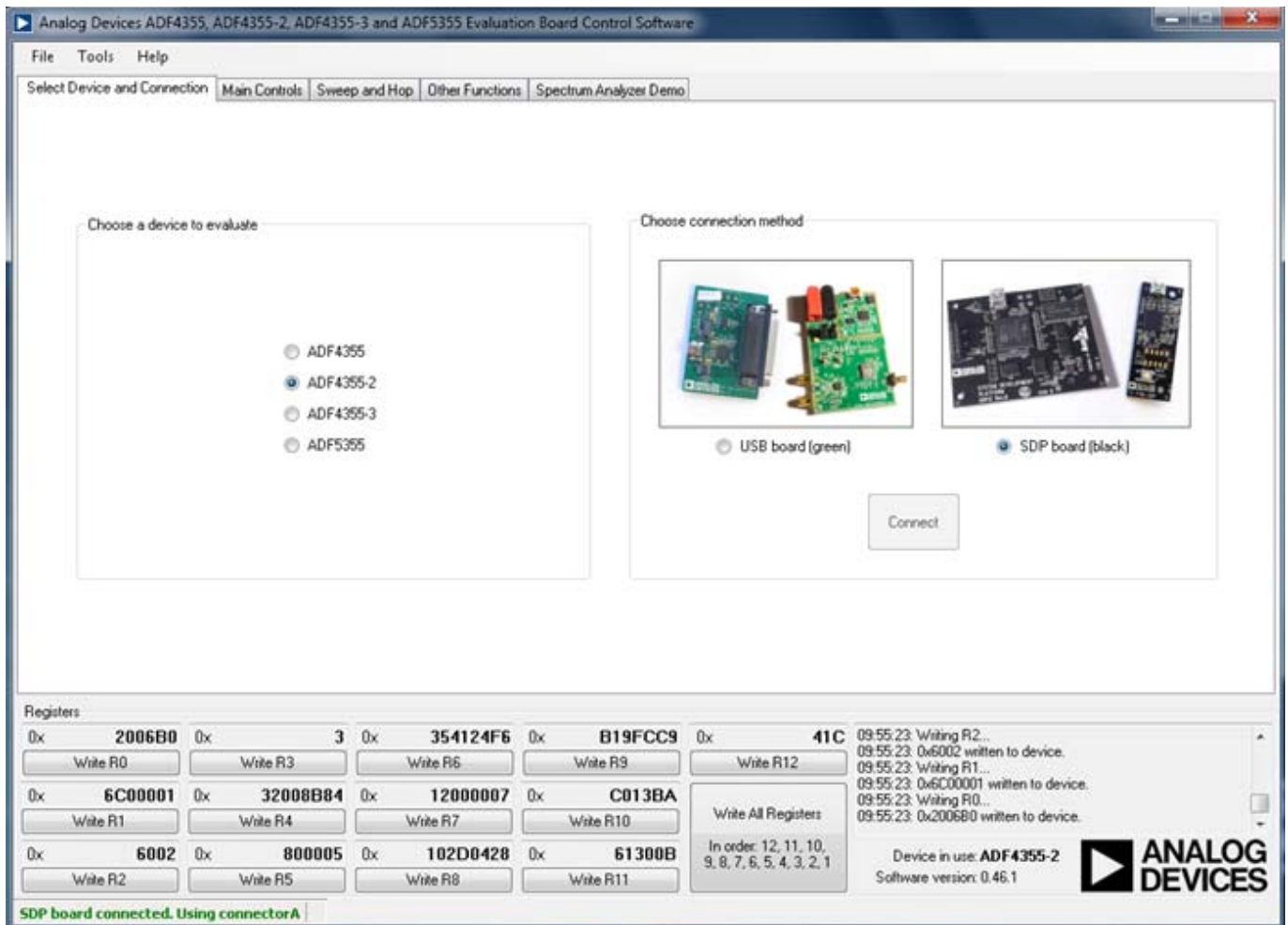

Figure 2. Software Front Panel Display—Select Device and Connection

EVALUATION BOARD HARDWARE

The [EV-ADF4355-2SD1Z](#) requires the [SDP-S](#) platform that uses the [EVAL-SDP-CS1Z](#). ([SDP-B](#) is not recommended.)

The [EV-ADF4355-2SD1Z](#) schematics are shown in Figure 7, Figure 8, and Figure 9. The silkscreens for the evaluation board are shown in Figure 10 and Figure 11.

POWER SUPPLIES

The board is powered by a 6 V power supply connected to the red and black banana connectors. Connect the red connector to a 6 V power supply and the black connector to ground.

The power supply circuitry allows the user two or three separate low dropout (LDO) regulators to feed the [ADF4355-2](#) (using fewer LDO regulators increases the risk of spur contaminated dc feeds).

The charge pump and VCO supply pins are driven from a 5 V [ADM7150](#) high performance, low noise regulator. The remaining supplies are powered from 3.3 V [ADM7150](#) high performance, low noise regulator.

LED1 indicates when the [ADF4355-2](#) is powered on. Use Switch S1 to switch the 6 V to the board on and off.

RF OUTPUT

The [EV-ADF4355-2SD1Z](#) has two pairs of SMA output connectors: RFOUTA+/RFOUTA– and RFOUTB+/RFOUTB– (differential outputs). Because they are sensitive to impedance mismatch, connect the RF outputs to equal load impedances. If only one port of a differential pair is used, terminate the complementary port with an equal load terminator (in general, a 50 Ω terminator).

LOOP FILTER

The loop filter schematic is included in the board schematic in Figure 7. Figure 3 shows the loop filter component placements. For lowest rms phase noise, use the following components (that are inserted on the evaluation board) with a 0.9 mA charge pump current:

- C60 = 1.2 nF, C59 = 33 nF, C61 = 390 pF, C73 = 10 pF
- R14 = 1 k Ω , R17 = 3.3 k Ω

Narrower loop filter bandwidths have lower spurious signals.

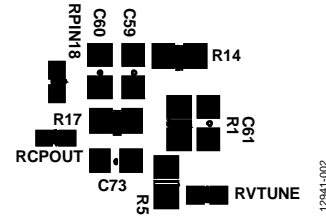

Figure 3. Loop Filter Placement

REFERENCE SOURCE

The evaluation board contains a 122.88 MHz differential output TCXO from Vectron International. If preferred, the user may supply either a single-ended or differential reference input to REFINA/REFINB SMA connectors. When using an external reference, remove R12 to disconnect the power rail to the TCXO.

To use a single-ended REFINx, connect a low noise 122.88 MHz reference source to SMA REFINB, and connect a 50 Ω terminator to SMA REFINA. Remove Resistor R27 (100 Ω). To use a differential REFINx, connect the differential signal to SMA REFINA and SMA REFINB. The differential REFINA/REFINB SMA connectors can operate to a 500 MHz input frequency.

In the schematic shown in Figure 7, the REF_{INA} pin of U1 ([ADF4355-2](#)) is connected to SMA REFINB, and the REF_{INB} pin of U1 ([ADF4355-2](#)) is connected to SMA REFINA. This schematic matches the evaluation board connections.

DEFAULT CONFIGURATION

All components necessary for local oscillator (LO) generation are inserted on the board. This board is shipped with the [ADF4355-2](#) synthesizer with an integrated VCO, a differential 122.88 MHz reference TCXO, and a 20 kHz loop filter (I_{CP} = 0.9 mA).

EVALUATION BOARD SETUP

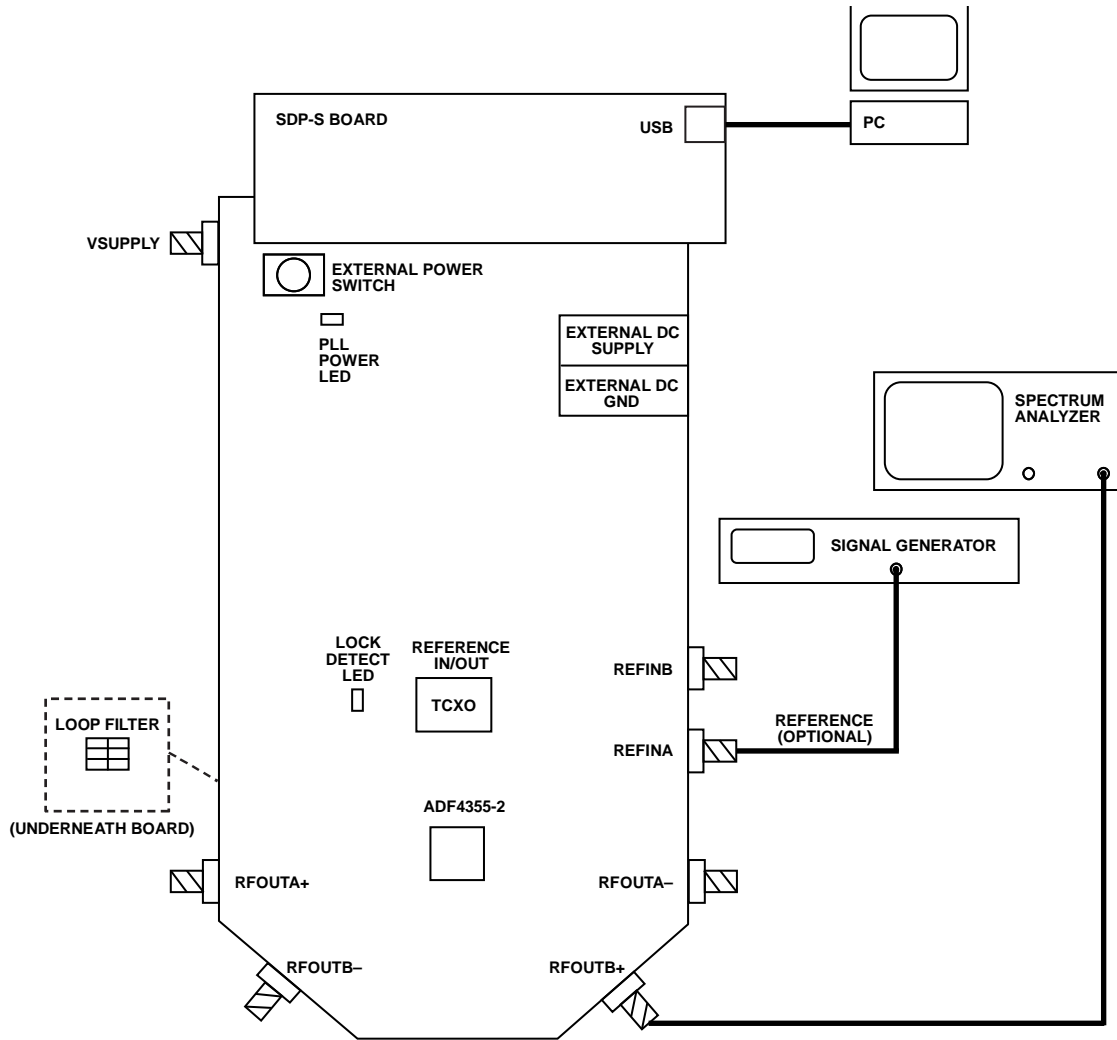

Figure 4. Evaluation Setup Block Diagram

125941-003

EVALUATION BOARD SOFTWARE

MAIN CONTROLS

The **Main Controls** tab (see Figure 5) selects the RF and user configurable register settings. Consult the register descriptions of the [ADF4355-2](#) data sheet for details. Default settings are recommended for most registers.

In the **RF Settings**, ensure that **VCOout(MHz)** equals the VCO frequency. Set the **Output divider** to give the required **RFoutA± (MHz)**.

Ensure that **Reference freq** equals the applied reference signal. The PFD frequency is calculated from the reference frequency, the R counter, the reference doubler, and the reference divide by 2. Ensure that the value in **PFD (MHz)** matches the value specified in the loop filter design.

In **Register 4**, program the **CP current** to match the value used for the loop filter design.

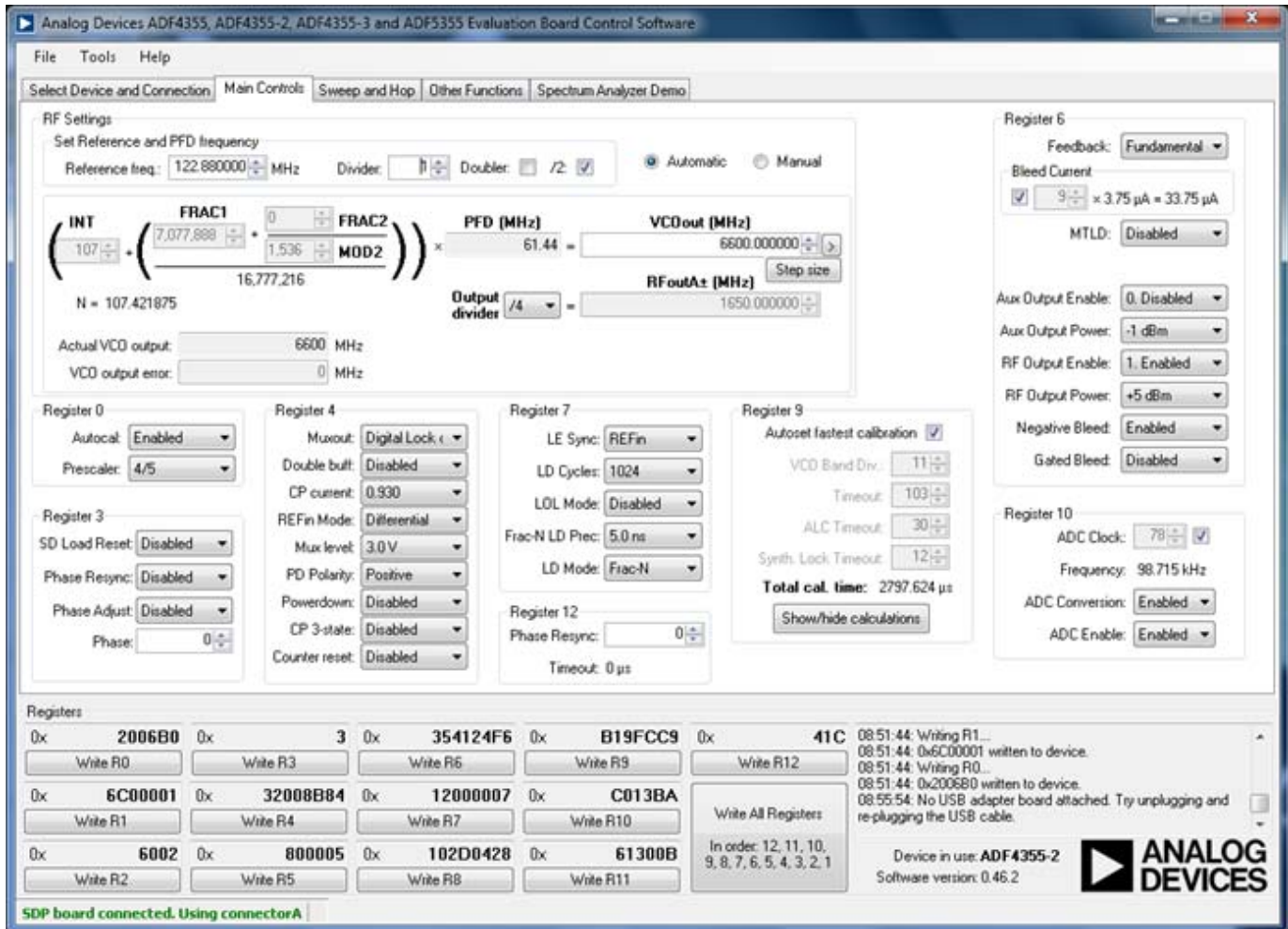

Figure 5. Software Front Panel Display—Main Controls

EVALUATION AND TEST

To evaluate and test the performance of the [ADF4355-2](#), use the following procedure:

1. Install the [ADF4355-2](#) software (see the [PLL Software Installation Guide](#)).
2. Follow the hardware driver installation procedure (Windows XP only).
3. Connect a 50 Ω terminator to RFOUTA-.
4. Connect the [EV-ADF4355-2SD1Z](#) board to the [SDP-S](#) board.
5. Connect the 6 V power supply to the banana connectors and power-on the board using S1 (check that LED1 is on).
6. Connect the USB cable from the [SDP-S](#) board to the PC.
7. Run the [ADF4355-2](#) software.
8. Select **ADF4355-2** and **SDP board (black)** in the **Select Device and Connection** tab of the software front panel display window (see Figure 2).
9. Click the **Main Controls** tab, and set the **VCOout (MHz)** to a frequency of 6600 MHz and the **Output divider** to 4 so that **RFoutA \pm (MHz)** equals 1.65 GHz.
10. Click **Write All Registers**.
11. Connect the spectrum analyzer to SMA connector RFOUTA+, see Figure 4 for a typical evaluation setup.
12. Measure the output spectrum and single sideband phase noise.

Figure 6 shows a phase noise plot of the SMA RFOUTA+ equal to 1.65 GHz.

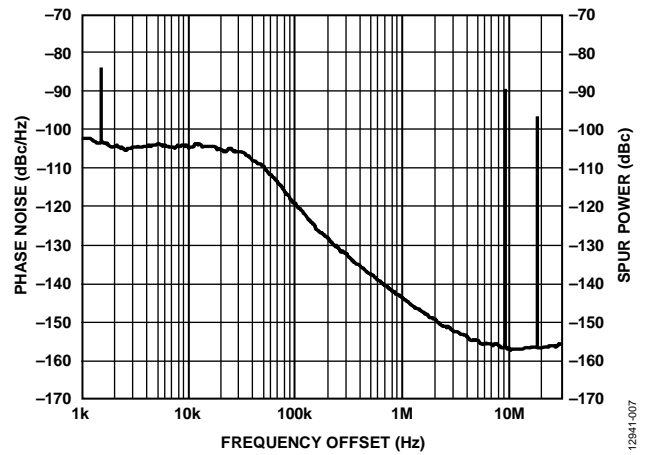
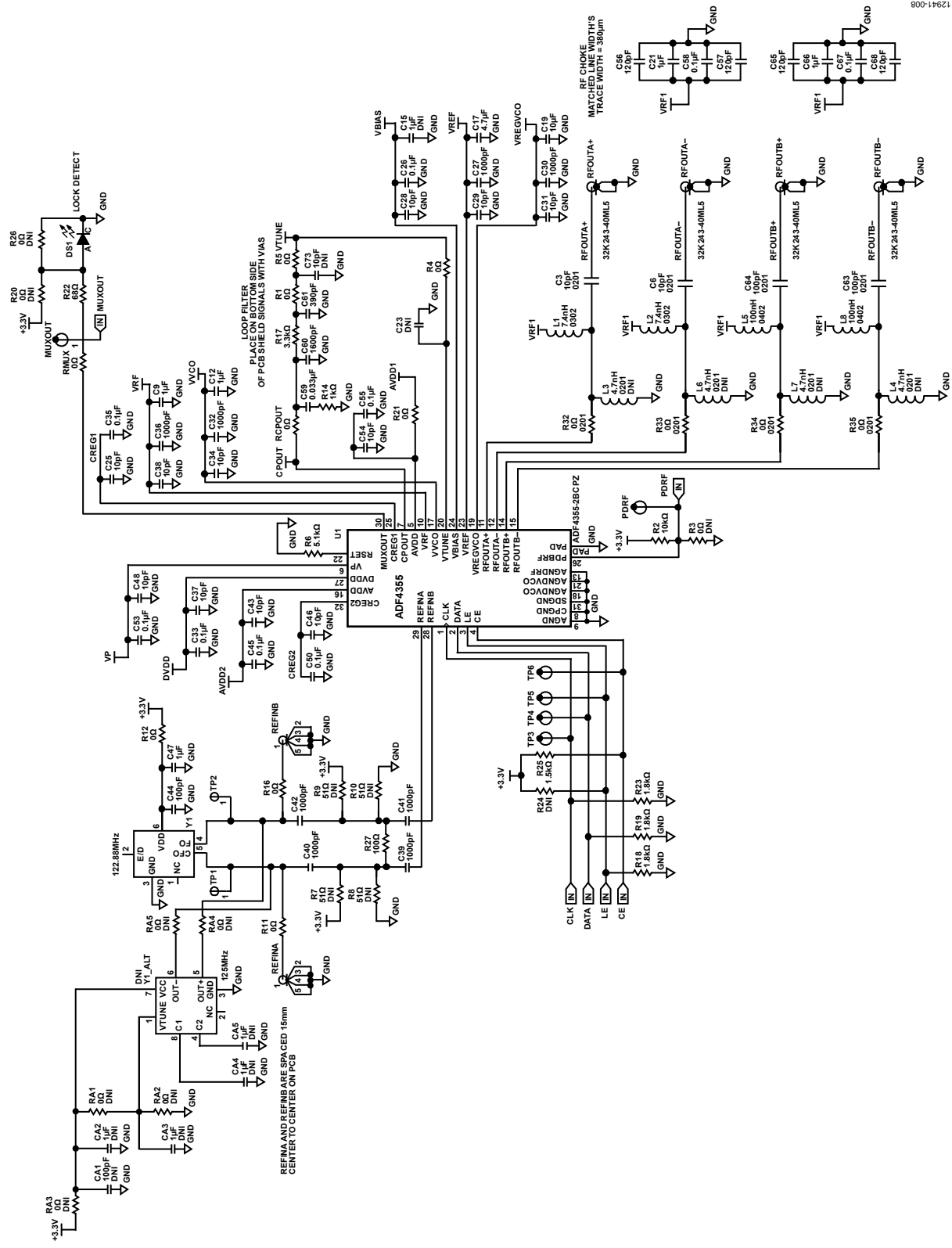

Figure 6. Single Sideband Phase Noise

EVALUATION BOARD SCHEMATICS AND ARTWORK



12941-008

Figure 7. Evaluation Board Schematic—Page 1

12941-009

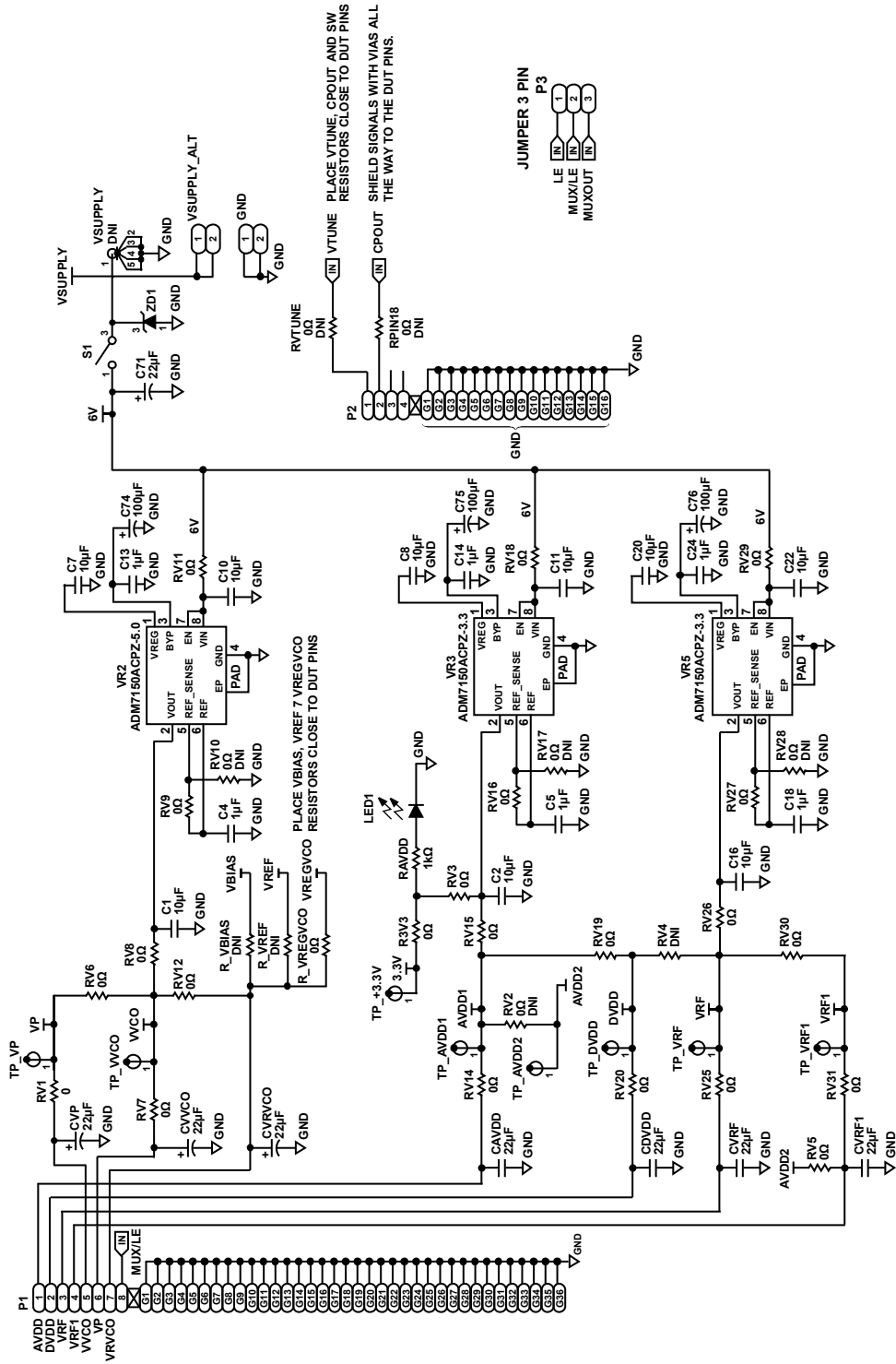

Figure 8. Evaluation Board Schematic—Page 2

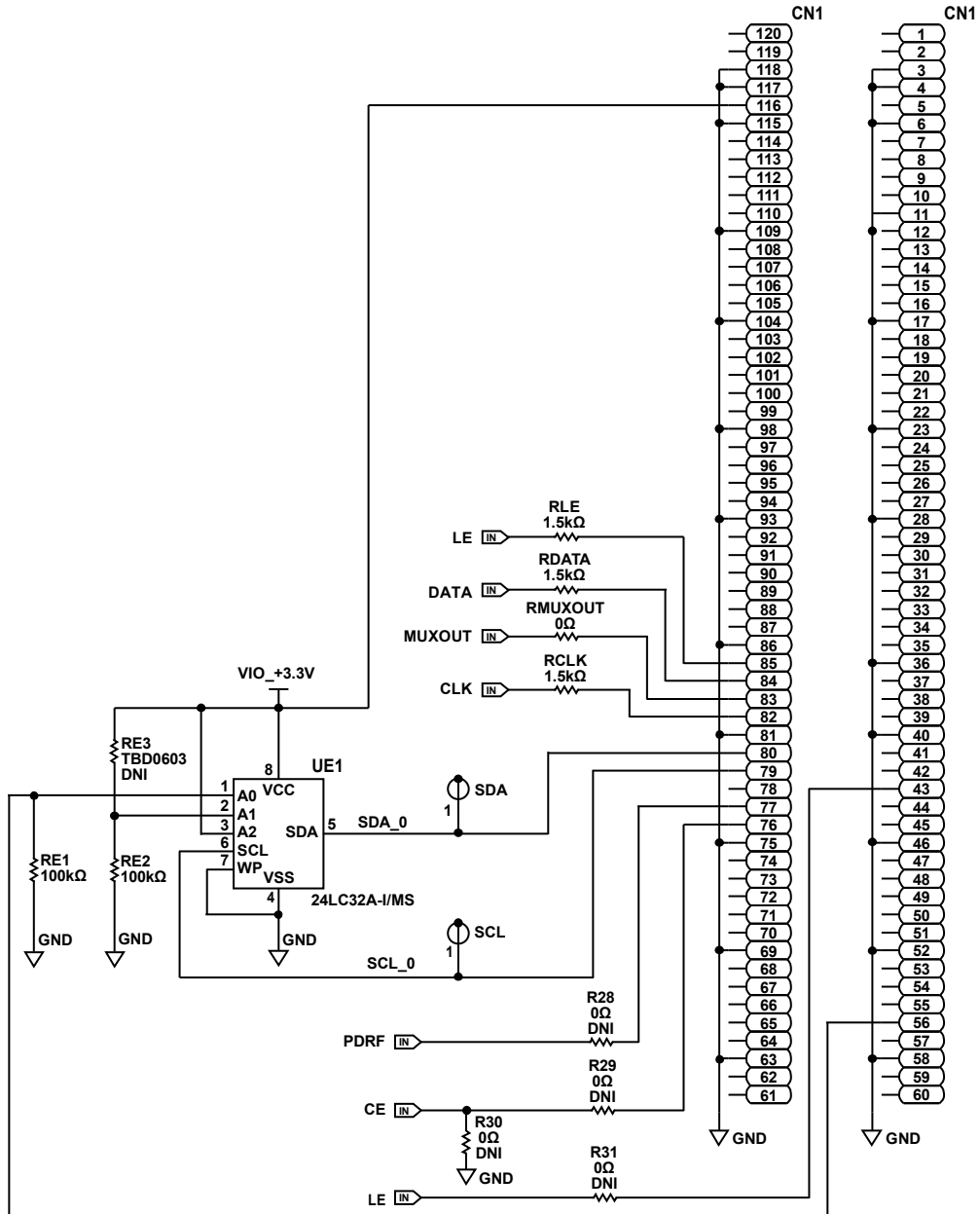

Figure 9. Evaluation Board Schematic—Page 3

12941-010

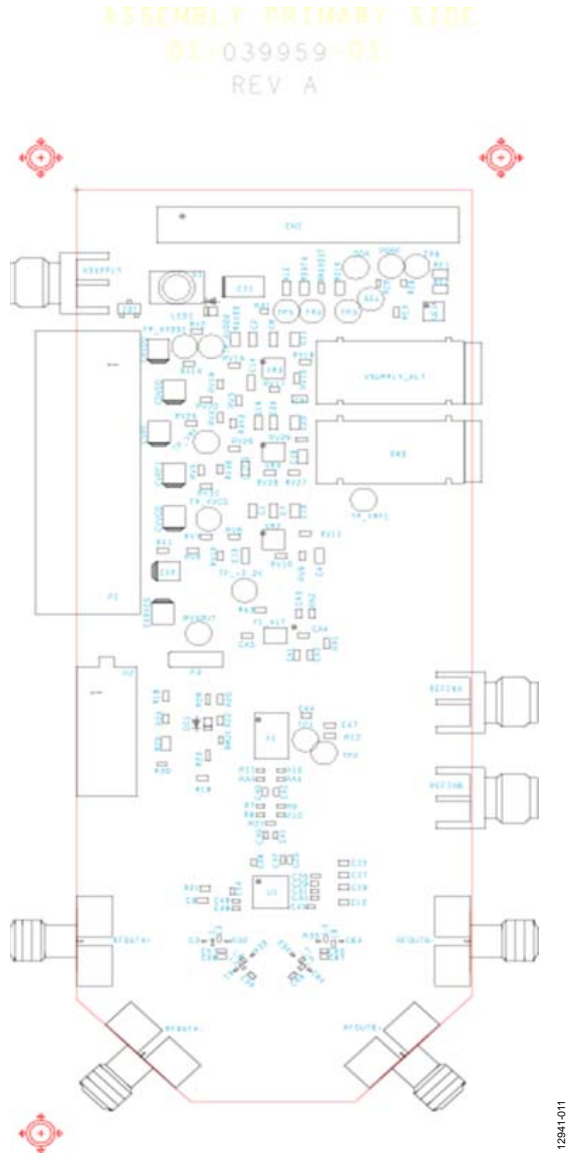
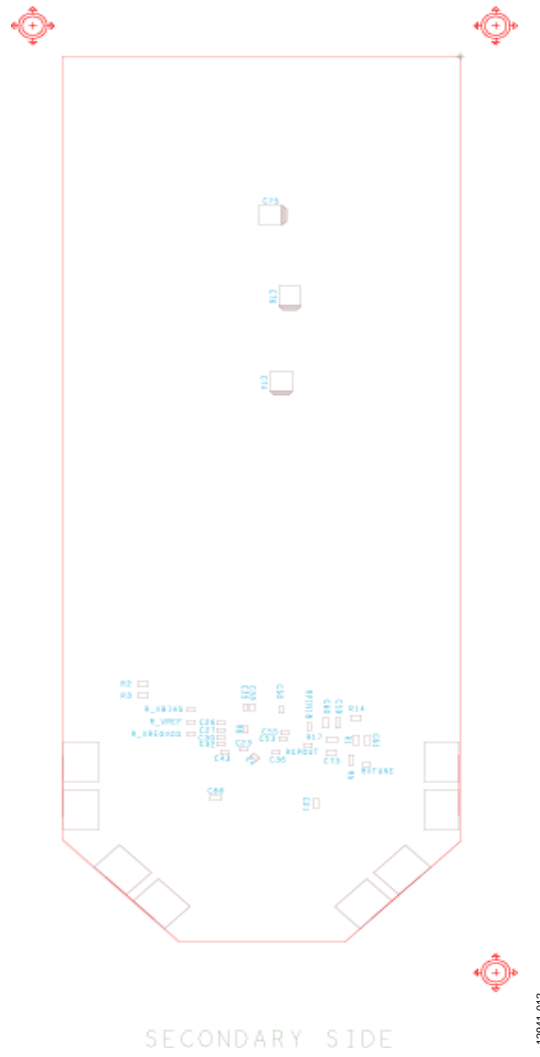

Figure 10. Evaluation Board Silk Screen—Top Side

ASSEMBLY SECONDARY SIDE
01-039959-02
REV-A



SECONDARY SIDE
Figure 11. Evaluation Board Silk Screen—Bottom Side

L2 GROUND
08-039959-08
REV A

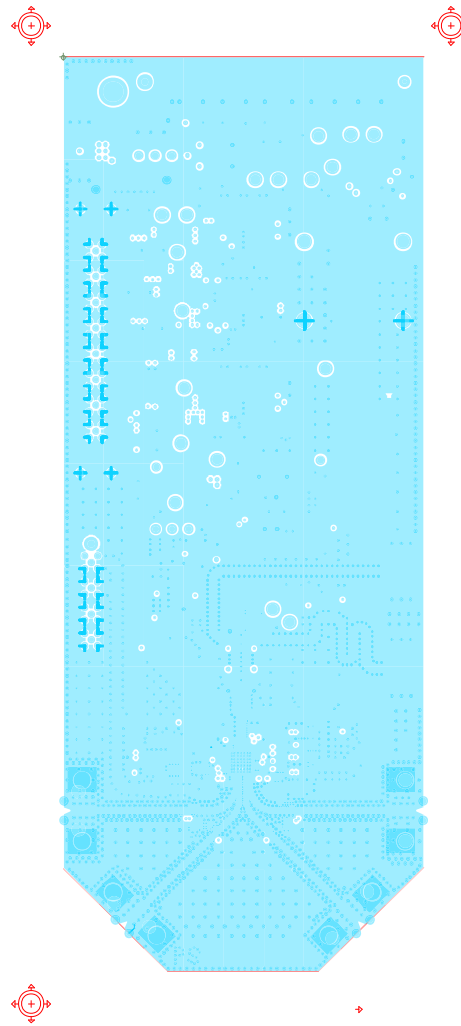

12941-014

Figure 13. Evaluation Board Layer 2—Ground

L3 POWER
08-039959-09
REV A

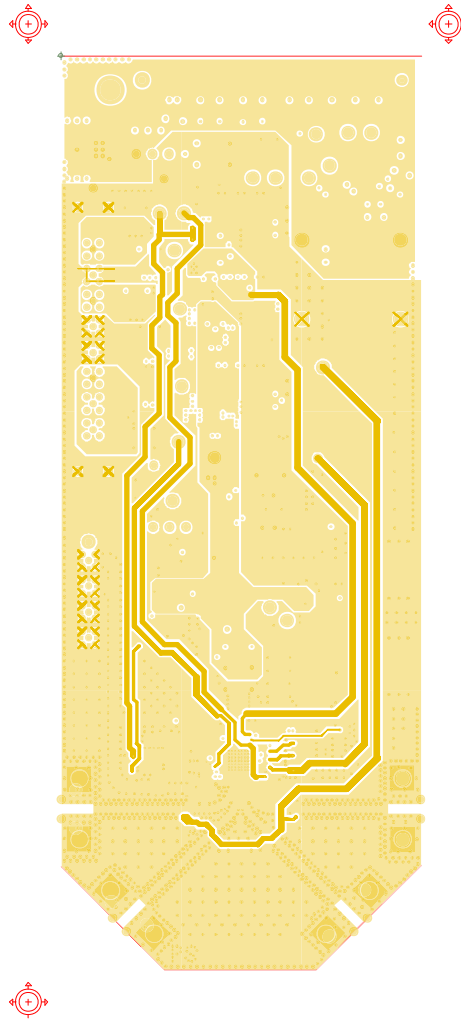

Figure 14. Evaluation Board Layer 3—Power

12941-015

L4 SECONDARY
08-039959-02
REV A

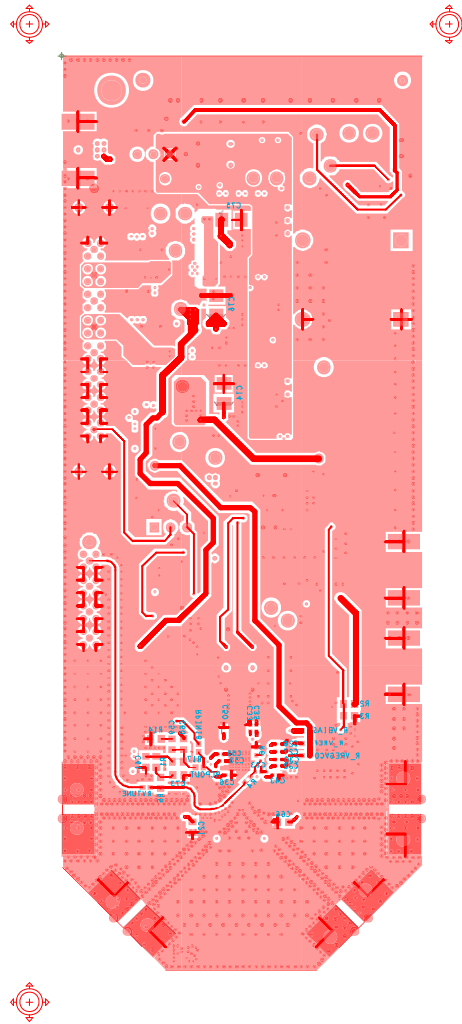

Figure 15. Evaluation Board Layer 4—Secondary

12941-016

ORDERING INFORMATION

BILL OF MATERIALS

Table 1.

Reference Designator	Description	Value	Manufacturer	Part Number
C1, C2, C7, C8, C10, C11, C16, C20, C22	Ceramic multilayer capacitor, X5R	10 μ F	TDK	C2012X5R1E106K085AC
C9, C12, C21, C47, C66	Ceramic capacitor, X7R	1 μ F	Allied Electronics	0603YC105KAT2A
C4, C5, C13, C14, C18, C24	Ceramic capacitor, X8R	1 μ F	TDK	C2012X8R1C105K125AB
C17	Ceramic capacitor, X5R	4.7 μ F	TDK	C1608X5R1C475K080AC
C19	Ceramic capacitor, X5R	10 μ F	TDK	C1608X5R1A106M080AC
C25, C28, C29, C31, C34, C37, C38, C43, C46, C48, C54	RF/microwave capacitor, C0G	10 pF	Allied Electronics	04025U100GAT2A
C26	Ceramic monochip capacitor, X5R	0.1 μ F	Murata	GRM155R61A104KA01D
C27, C30, C32, C36, C39 to C42	Ceramic capacitor, C0G, 0402	1000 pF	Murata	GRM1555C1H102JA01
C3, C6	Chip ceramic capacitor, RF	10 pF	Allied Electronics	0201ZK100GBSTR
C33, C35, C45, C50, C53, C55, C58, C67	Ceramic capacitor, X7R	0.1 μ F	KEMET	C0402C104K4RACTU
C44	Ceramic capacitor, NP0	100 pF	Yageo	2238 867 15101
C56, C57, C65, C68	Ceramic capacitor, C0G, 0402	120 pF	Murata	GRM1555C1H121JA01
C59	Ceramic capacitor, X7R, 0603	0.033 μ F	Murata	GRM188R71C333KA01D
C60	Monolithic, ceramic capacitor, NP0	1600 pF	Murata	GRM1885C1H162JA01D
C61	Chip capacitor, C0G, 0603	390 pF	TDK	C1608C0G1H391J
C63, C64	Ceramic capacitor, 0201, X7R	100 pF	Murata	GRM033R71E101KA01D
C71	Tantalum solid electrolytic capacitor	22 μ F	Allied Electronics	TCJC226M025R0100
C74 to C76	Tantalum chip capacitor	100 μ F	Allied Electronics	TAJB107K006R
CVP, CVRF, CAVDD, CDVDD, CVRF1, CVVCO, CVRVC0	Tantalum surface-mount device (SMD) capacitor	22 μ F	Allied Electronics	TAJB226K016R
CN1	Printed circuit board (PCB), vertical type receptacle, SMD connector		HRS	FX8-120S-SV(21)
DS1, LED1	570 nm SMD (green) LED		Avago Technologies	HSMG-C170
GND	PCB single socket (black) connector		Del-Tron Precision, Inc.	571-0100
L1, L2	Chip inductor	7.4 nH	Coilcraft	0302CS-7N4XJLU
L5, L8	Chip inductor	100 nH	Coilcraft	0402CS-R10XJLU
SCL, SDA, TP1 to TP6, PDRF, TP_VP, MUXOUT, TP_VRF, TP_DVDD, TP_VRF1, TP_VVCO, TP_+3.3V, TP_AVDD1, TP_AVDD2	PCB test point connector (yellow)		Components Corporation	TP-104-01-04
P3	Connector PCB, Header 3		Molex	22-28-4033
R1, R4, R5, R12, R21, RV1, RV3, RV5 to RV9, R3V3, RV11, RV12, RV14 to RV16, RV18 to RV20, RV25 to RV27, RV29 to RV31, RMUXOUT	Film SMD resistor, 0603	0 Ω	Multicomp	MC0603WG00000T5E-TC
R11, R16, RMUX, RCPOUT, R_VREGVCO	Thick film chip resistor	0 Ω	Multicomp	0402WGF0000TCE
R14	Film SMD resistor, 0603	1 k Ω	Multicomp	MC 0.063W 0603 1% 1K
R17	Film SMD resistor, 0603	3.3 k Ω	Multicomp	MC 0.063W 0603 1% 3K3
R18, R19, R23	Film SMD resistor, 0603	1.8 k Ω	Multicomp	MC 0.063W 0603 1% 1K8
R2	Thick film chip resistor	10 k Ω	Multicomp	MC 0.063W 0603 1% 10K
R22	Film SMD resistor, 0603	68 Ω	Multicomp	MC 0.063W 0603 1% 68R
R25, RLE, RCLK, RDATA	Precision thick film chip resistor, R0805	1.5 k Ω	Panasonic	ERJ-6ENF1501V
R27	High-frequency thin film chip resistor	100 Ω	Vishay	FC0402E1000BST1

Reference Designator	Description	Value	Manufacturer	Part Number
R32 to R35	Chip SMD resistor, 0201	0 Ω	Panasonic	ERJ-1GE0R00C
R6	STD thick film chip resistor	5.1 k Ω	Vishay	CRCW04025K10FKED
RAVDD	Precision thick film chip resistor, R0805	1 k Ω	Panasonic	ERJ-6ENF1001V
RE1, RE2	Precision thick film chip resistor, R0805	100 k Ω	Panasonic	ERJ-6ENF1003V
REFINA, REFINB	PCB coaxial SMA end launch connector		Johnson	142-0701-801
RFOUTA+, RFOUTA-, RFOUTB+, RFOUTB-	PCB SMA RA jack connector		Rosenberger	32K243-40ML5
S1	SW SPST momentary		Alcoswitch	TT11AGPC-1
U1	Microwave wideband synthesizer with integrated VCO		Analog Devices	ADF4355-2BCPZ
UE1	IC 32 kB serial EEPROM		Microchip Technology, Inc.	24LC32A-I/MS
VR2	800 mA, ultralow noise high power supply rejection ratio (PSRR), 5.0 V output RF linear regulator		Analog Devices	ADM7150ACPZ-5.0
VR3, VR5	800 mA, ultralow noise high PSRR, 3.3 V output RF linear regulator		Analog Devices	ADM7150ACPZ-3.3
VSUPPLY_ALT	PCB single socket(red) connector		Del-Tron Precision, Inc.	571-0500
Y1	IC crystal LVPECL, LVDS oscillator		Vectron International	VCC6-LAB-122M880000
ZD1	BZX84C 6.8 V Zener SOT-23 diode		Philips	BZX84-C6V8
VSUPPLY	PCB coaxial SMA end launch connector		Johnson	DNI

**ESD Caution**

ESD (electrostatic discharge) sensitive device. Charged devices and circuit boards can discharge without detection. Although this product features patented or proprietary protection circuitry, damage may occur on devices subjected to high energy ESD. Therefore, proper ESD precautions should be taken to avoid performance degradation or loss of functionality.

Legal Terms and Conditions

By using the evaluation board discussed herein (together with any tools, components documentation or support materials, the "Evaluation Board"), you are agreeing to be bound by the terms and conditions set forth below ("Agreement") unless you have purchased the Evaluation Board, in which case the Analog Devices Standard Terms and Conditions of Sale shall govern. Do not use the Evaluation Board until you have read and agreed to the Agreement. Your use of the Evaluation Board shall signify your acceptance of the Agreement. This Agreement is made by and between you ("Customer") and Analog Devices, Inc. ("ADI"), with its principal place of business at One Technology Way, Norwood, MA 02062, USA. Subject to the terms and conditions of the Agreement, ADI hereby grants to Customer a free, limited, personal, temporary, non-exclusive, non-sublicensable, non-transferable license to use the Evaluation Board FOR EVALUATION PURPOSES ONLY. Customer understands and agrees that the Evaluation Board is provided for the sole and exclusive purpose referenced above, and agrees not to use the Evaluation Board for any other purpose. Furthermore, the license granted is expressly made subject to the following additional limitations: Customer shall not (i) rent, lease, display, sell, transfer, assign, sublicense, or distribute the Evaluation Board; and (ii) permit any Third Party to access the Evaluation Board. As used herein, the term "Third Party" includes any entity other than ADI, Customer, their employees, affiliates and in-house consultants. The Evaluation Board is NOT sold to Customer; all rights not expressly granted herein, including ownership of the Evaluation Board, are reserved by ADI. CONFIDENTIALITY. This Agreement and the Evaluation Board shall all be considered the confidential and proprietary information of ADI. Customer may not disclose or transfer any portion of the Evaluation Board to any other party for any reason. Upon discontinuation of use of the Evaluation Board or termination of this Agreement, Customer agrees to promptly return the Evaluation Board to ADI. ADDITIONAL RESTRICTIONS. Customer may not disassemble, decompile or reverse engineer chips on the Evaluation Board. Customer shall inform ADI of any occurred damages or any modifications or alterations it makes to the Evaluation Board, including but not limited to soldering or any other activity that affects the material content of the Evaluation Board. Modifications to the Evaluation Board must comply with applicable law, including but not limited to the RoHS Directive. TERMINATION. ADI may terminate this Agreement at any time upon giving written notice to Customer. Customer agrees to return to ADI the Evaluation Board at that time. LIMITATION OF LIABILITY. THE EVALUATION BOARD PROVIDED HEREUNDER IS PROVIDED "AS IS" AND ADI MAKES NO WARRANTIES OR REPRESENTATIONS OF ANY KIND WITH RESPECT TO IT. ADI SPECIFICALLY DISCLAIMS ANY REPRESENTATIONS, ENDORSEMENTS, GUARANTEES, OR WARRANTIES, EXPRESS OR IMPLIED, RELATED TO THE EVALUATION BOARD INCLUDING, BUT NOT LIMITED TO, THE IMPLIED WARRANTY OF MERCHANTABILITY, TITLE, FITNESS FOR A PARTICULAR PURPOSE OR NON-INFRINGEMENT OF INTELLECTUAL PROPERTY RIGHTS. IN NO EVENT WILL ADI AND ITS LICENSORS BE LIABLE FOR ANY INCIDENTAL, SPECIAL, INDIRECT, OR CONSEQUENTIAL DAMAGES RESULTING FROM CUSTOMER'S POSSESSION OR USE OF THE EVALUATION BOARD, INCLUDING BUT NOT LIMITED TO LOST PROFITS, DELAY COSTS, LABOR COSTS OR LOSS OF GOODWILL. ADI'S TOTAL LIABILITY FROM ANY AND ALL CAUSES SHALL BE LIMITED TO THE AMOUNT OF ONE HUNDRED US DOLLARS (\$100.00). EXPORT. Customer agrees that it will not directly or indirectly export the Evaluation Board to another country, and that it will comply with all applicable United States federal laws and regulations relating to exports. GOVERNING LAW. This Agreement shall be governed by and construed in accordance with the substantive laws of the Commonwealth of Massachusetts (excluding conflict of law rules). Any legal action regarding this Agreement will be heard in the state or federal courts having jurisdiction in Suffolk County, Massachusetts, and Customer hereby submits to the personal jurisdiction and venue of such courts. The United Nations Convention on Contracts for the International Sale of Goods shall not apply to this Agreement and is expressly disclaimed.

©2015 Analog Devices, Inc. All rights reserved. Trademarks and registered trademarks are the property of their respective owners.
UG12941-0-5/15(0)



www.analog.com

X-ON Electronics

Largest Supplier of Electrical and Electronic Components

Click to view similar products for [Clock & Timer Development Tools](#) category:

Click to view products by [Analog Devices](#) manufacturer:

Other Similar products are found below :

[AD9517-0A/PCBZ](#) [AD9517-2A/PCBZ](#) [AD9522-4/PCBZ](#) [AD9520-5PCBZ](#) [AD9553/PCBZ](#) [ADCLK914PCBZ](#) [LMH2180SDEVAL](#) [DSC400-0333Q0032KE1-EVB](#) [TDGL013](#) [MAX2880EVKIT#](#) [MAX2750EVKIT](#) [MAX2752EVKIT](#) [ADCLK946PCBZ](#) [ADCLK946/PCBZ](#) [MAX2622EVKIT](#) [EKIT01-HMC1032LP6G](#) [Si5332-8IX-EVB](#) [RV-2251-C3-EVALUATION-BOARD](#) [Si5332-12IX-EVB](#) [RV-3029-C2-EVALUATION-BOARD-OPTION-B](#) [Si5332-6IX-EVB](#) [SKY72310-11-EVB](#) [EV1HMC8364LP6G](#) [RV-8263-C7-EVALUATION-BOARD](#) [EVK9FGV1002](#) [EVK9FGV1008](#) [EV1HMC6832ALP5L](#) [EVAL01-HMC830LP6GE](#) [EVAL01-HMC911LC4B](#) [TS3002DB](#) [125605-HMC702LP6CE](#) [LMX2487E-EVM](#) [MIKROE-2481](#) [2045](#) [EKIT01-HMC835LP6G](#) [EKIT01-HMC834LP6GE](#) [TS3006DB](#) [DSC-TIMEFLASH2-KIT1](#) [110227-HMC510LP5](#) [110227-HMC513LP5](#) [AD9515/PCBZ](#) [ADCLK948/PCBZ](#) [ADCLK954/PCBZ](#) [112261-HMC739LP4](#) [ADCLK925/PCBZ](#) [AD9522-0/PCBZ](#) [AD9520-4/PCBZ](#) [AC164147](#) [DFR0469](#) [LMK04133EVAL/NOPB](#)