



## GaAs MMIC SPDT NON-REFLECTIVE SWITCH, DC - 28.0 GHz

### Typical Applications

The HMC547LC3 is ideal for:

- Fiber Optics & Broadband Telecom
- Microwave Radio & VSAT
- Military Radios, Radar, & ECM
- Test Instrumentation

### Features

- High Isolation: 45 dB @ 10 GHz  
40 dB @ 20 GHz
- Low Insertion Loss: 1.6 dB @ 10 GHz  
1.9 dB @ 20 GHz
- Fast Switching: 6 ns
- Non-Reflective Design
- 16 Lead Ceramic 3x3 mm SMT Package: 9mm<sup>2</sup>

### Functional Diagram

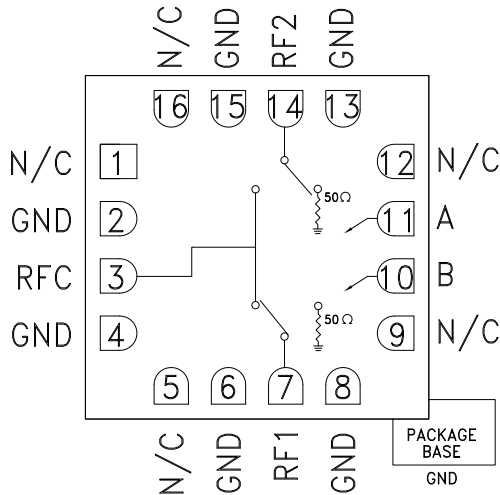

### General Description

The HMC547LC3 is a general purpose broadband high isolation non-reflective GaAs MESFET SPDT switch in a ceramic 3x3 mm leadless surface mount package. Covering DC to 28.0 GHz, the switch offers over 40 dB isolation and less than 2 dB insertion loss at midband. The wide bandwidth, fast switching, and compact size make this absorptive SPDT ideal for military EW/ECM and test equipment applications. The switch operates using complementary negative control voltage logic lines of -5/0V and requires no bias supply.

### Electrical Specifications, $T_A = +25^\circ C$ , With 0/-5V Control, 50 Ohm System

Parameter	Frequency	Min.	Typ.	Max.	Units
Insertion Loss	DC - 10.0 GHz		1.6	2.2	dB
	10.0 - 20.0 GHz		1.9	2.5	dB
	20.0 - 28.0 GHz		2.4	3.0	dB
Isolation	DC - 10.0 GHz	40	45		dB
	10.0 - 20.0 GHz	34	40		dB
	20.0 - 28.0 GHz	30	34		dB
Return Loss	"On State"		17		dB
Return Loss RF1, RF2	"Off State"		25		dB
	DC - 10.0 GHz		15		dB
	10.0 - 20.0 GHz		8		dB
Input Power for 1 dB Compression	DC - 0.5 GHz		16		dBm
	0.5 - 28.0 GHz	20	23		dBm
Input Third Order Intercept (Two-Tone Input Power= +7 dBm Each Tone)	DC - 0.5 GHz		26		dBm
	0.5 - 28.0 GHz		46		dBm
Switching Characteristics	DC - 28.0 GHz	tRISE, tFALL (10/90% RF)	3		ns
		tON, tOFF (50% CTL to 10/90% RF)	6		ns



**GaAs MMIC SPDT NON-REFLECTIVE SWITCH, DC - 28.0 GHz**

**Insertion Loss**

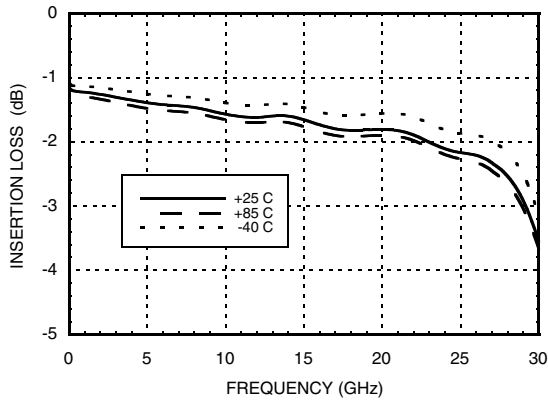

**Return Loss**

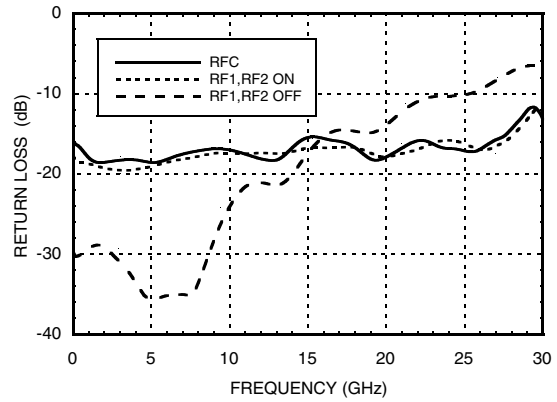

**Isolation Between Ports RFC and RF1/RF2**

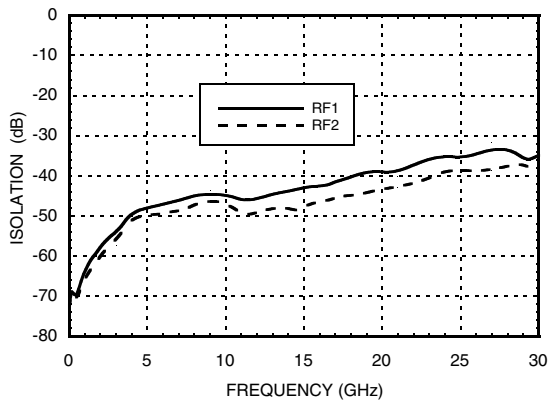

**Isolation Between Ports RF1 and RF2**

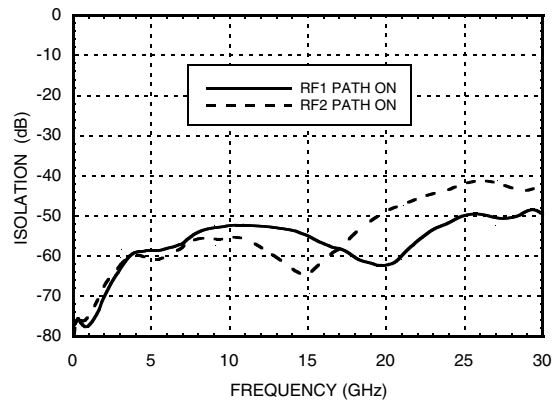

**Input P1dB and P0.1dB Compression Point**

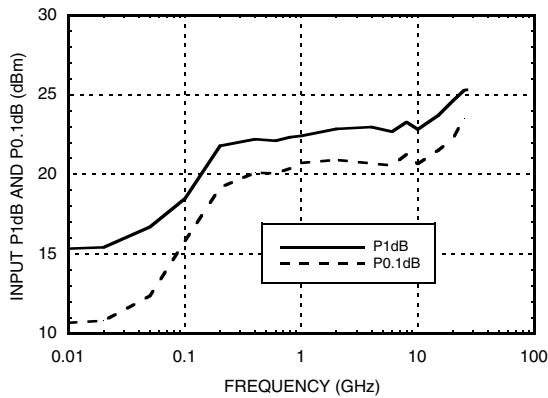

**Input Third Order Intercept Point**

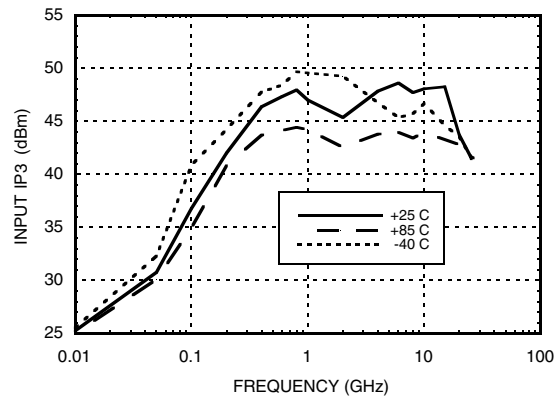

Information furnished by Analog Devices is believed to be accurate and reliable. However, no responsibility is assumed by Analog Devices for its use, nor for any infringements of patents or other rights of third parties that may result from its use. Specifications subject to change without notice. No license is granted by implication or otherwise under any patent or patent rights of Analog Devices. Trademarks and registered trademarks are the property of their respective owners.

For price, delivery, and to place orders: Analog Devices, Inc., One Technology Way, P.O. Box 9106, Norwood, MA 02062-9106 Phone: 781-329-4700 • Order online at [www.analog.com](http://www.analog.com) Application Support: Phone: 1-800-ANALOG-D



## GaAs MMIC SPDT NON-REFLECTIVE SWITCH, DC - 28.0 GHz

### Absolute Maximum Ratings

RF Input Power (A, B = 0V/-5V)	+25 dBm
Control Voltage Range (A & B)	+5.0V to -7.5V
Hot Switch Power Level (A, B = 0V/-5V)	+22 dBm
Channel Temperature	150 °C
Continuous Pdiss (T=85°C) (derate 3.3 mW/°C above 85°C) (Insertion Loss Path)	0.215 W
Thermal Resistance (Insertion Loss Path)	302 °C/W
Continuous Pdiss (T=85°C) (derate 5.6 mW/°C above 85°C) (Terminated Path)	0.363 W
Thermal Resistance (Terminated Path)	179 °C/W
Storage Temperature	-65 to +150 °C
Operating Temperature	-40 to +85 °C
ESD Sensitivity (HBM)	Class 1A

### Control Voltages

State	Bias Condition
Low	0 to -0.5V @ 10 uA Max.
High	-5V @ 3 uA Typ. to -7V @ 10 uA Typ. (± 0.5V)

### Truth Table

Control Input		Signal Path State	
A	B	RFC to RF1	RFC to RF2
High	Low	On	Off
Low	High	Off	On



**ELECTROSTATIC SENSITIVE DEVICE  
OBSERVE HANDLING PRECAUTIONS**



**GaAs MMIC SPDT NON-REFLECTIVE SWITCH, DC - 28.0 GHz**

**Outline Drawing**

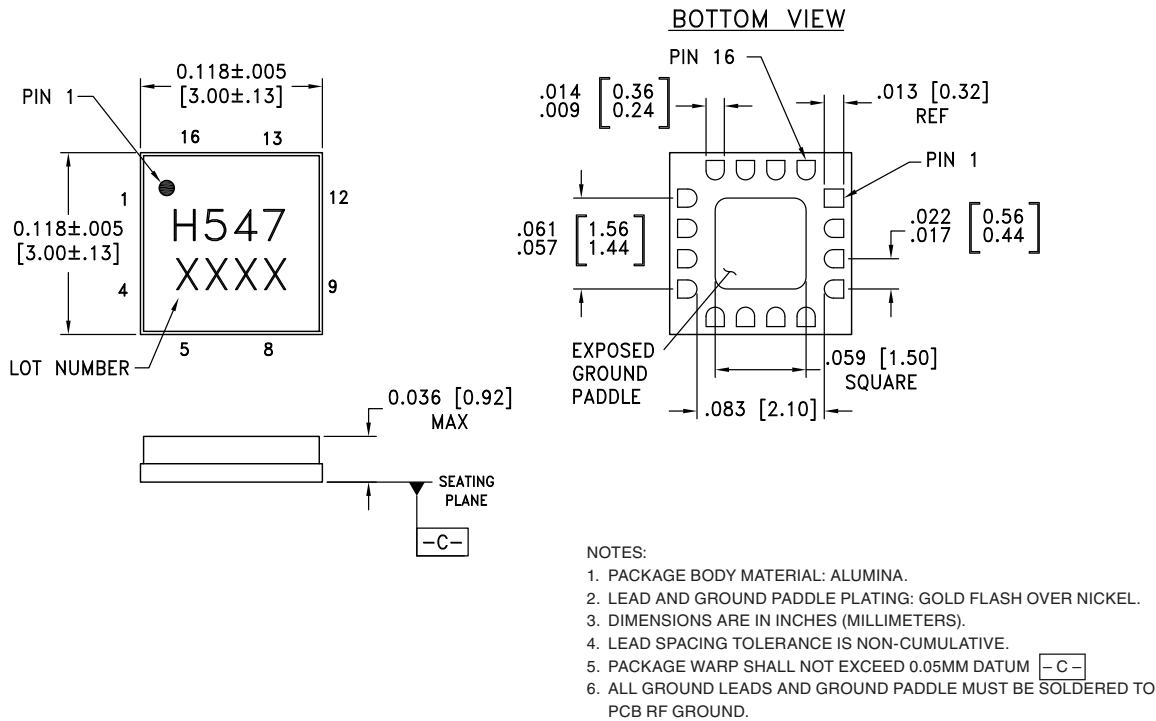

**Package Information**

Part Number	Package Body Material	Lead Finish	MSL Rating	Package Marking <sup>[2]</sup>
HMC547LC3	Alumina, White	Gold over Nickel	MSL3 <sup>[1]</sup>	H547 XXXX

[1] Max peak reflow temperature of 260 °C

[2] 4-Digit lot number XXXX

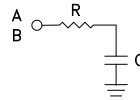

**GaAs MMIC SPDT NON-REFLECTIVE  
SWITCH, DC - 28.0 GHz**
**Pin Descriptions**

Pin Number	Function	Description	Interface Schematic
1, 5, 9, 12, 16	N/C	This pin should be connected to PCB RF ground to maximize isolation	
2, 4, 6, 8, 13, 15	GND	Package bottom has exposed metal paddle that must also be connected to PCB RF ground.	
3, 7, 14	RFC, RF1, RF2	This pin is DC coupled and matched to 50 Ohm. Blocking capacitors are required if RF line potential is not equal to 0V.	
10	B	See truth table and control voltage table.	
11	A	See truth table and control voltage table.	

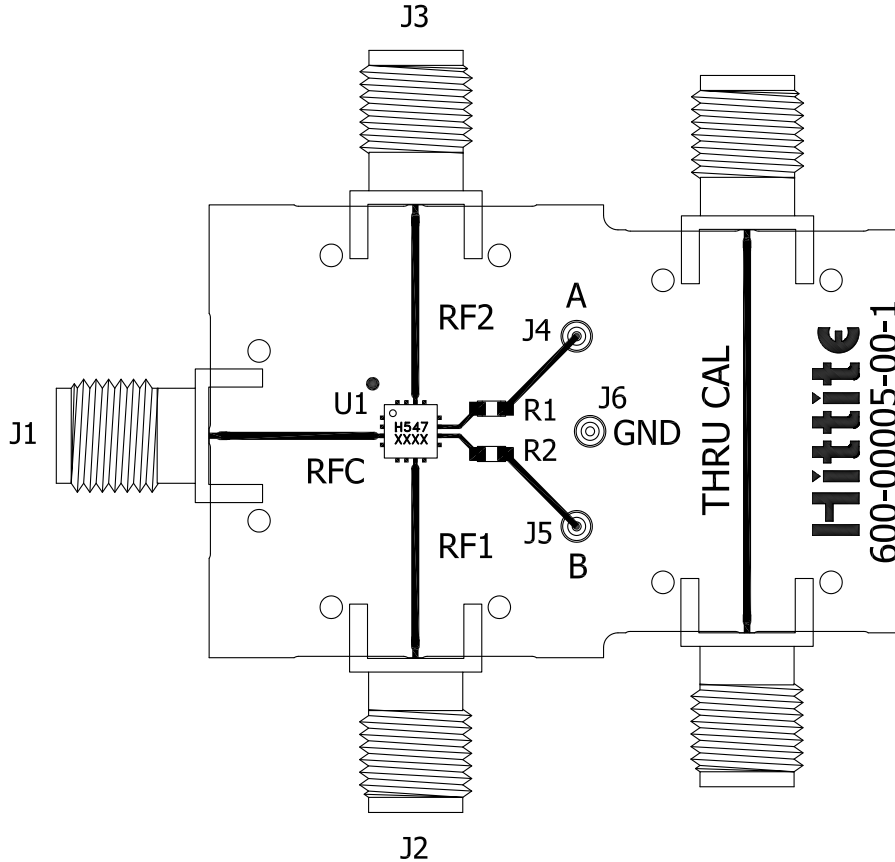

**GaAs MMIC SPDT NON-REFLECTIVE SWITCH, DC - 28.0 GHz**

**Evaluation PCB**



**List of Materials for Evaluation PCB EVAL01-HMC547LC3 [1]**

Item	Description
J1 - J3	PCB Mount SRI SMA Connector
J4 - J6	DC Pin
R1 - R2	100 Ohm Resistor, 0603 Pkg.
U1	HMC547LC3 SPDT Switch
PCB [2]	600-00005-00-1 Evaluation PCB

[1] Reference this number when ordering complete evaluation PCB

[2] Circuit Board Material: Rogers 4350

The circuit board used in the application should be generated with proper RF circuit design techniques. Signal lines at the RF port should have 50 Ohm impedance and the package ground leads and package bottom should be connected directly to the ground plane similar to that shown above. The evaluation circuit board shown above is available from Hittite Microwave Corporation upon request.

## X-ON Electronics

Largest Supplier of Electrical and Electronic Components

*Click to view similar products for [RF Development Tools](#) category:*

*Click to view products by [Analog Devices](#) manufacturer:*

Other Similar products are found below :

[MAAP-015036-DIEEV2](#) [EV1HMC1113LP5](#) [EV1HMC252AQS24](#) [EV1HMC6146BLC5A](#) [EV1HMC637ALP5](#) [EVAL01-HMC1048LC3B](#)  
[EVAL01-HMC661LC4B](#) [EVAL-ADF7020-1DBZ4](#) [EVAL-ADF7020-1DBZ5](#) [EVAL-ADF7020-1DBZ6](#) [EVAL-ADF7020-1DBZ8](#) [EVAL-](#)  
[ADF7021DB9Z](#) [EVAL-ADF7021DBJZ](#) [EVAL-ADF7021DBZ2](#) [EVAL-ADF7021DBZ6](#) [EVAL-ADF7021-NDBZ2](#) [EVAL-ADF7021-VDB3Z](#)  
[EVAL-ADF7023DB3Z](#) [EVAL-ADF7023-JDB3Z](#) [EVAL-ADF70XXEKZ1](#) [EVAL-ADF7241DB1Z](#) [F0440EVBI](#) [F1241EVBI](#) [F1423EVB-DI](#)  
[F1423EVB-SI](#) [F1701EVBI](#) [F1751EVBI](#) [F2250EVBI](#) [MICRF219A-433 EV](#) [122410-HMC686LP4E](#) [AD6679-500EBZ](#) [126223-](#)  
[HMC789ST89E](#) [ADL5363-EVALZ](#) [ADL5369-EVALZ](#) [130437-HMC1010LP4E](#) [131352-HMC1021LP4E](#) [131372-HMC951LP4E](#) [130436-](#)  
[HMC1010LP4E](#) [DEMOBOARD-U2790B](#) [ATR2406-PNQW](#) [EKIT01-HMC1197LP7F](#) [Si4705-D60-EVB](#) [Si4835-Demo](#) [LMV228SDEVAL](#)  
[SKYA21001-EVB](#) [SMP1331-08-EVB](#) [EV1HMC618ALP3](#) [EV1HMC641ALC4](#) [EV1HMC8410LP2F](#) [EVAL\\_PAN4555ETU](#)