

GaAs pHEMT MMIC 4 WATT POWER AMPLIFIER, 12 - 16 GHz

Typical Applications

The HMC5879LS7 is ideal for:

- Point-to-Point Radios
- Point-to-Multi-Point Radios
- VSAT & SATCOM
- Military & Space

Features

- Saturated Output Power: +37 dBm @ 22% PAE
- High Output IP3: +44 dBm
- High Gain: 28 dB
- DC Supply: +7V @ 2400 mA
- No External Matching Required
- 18 Lead 7x7 mm SMT Package: 49 mm²

Functional Diagram

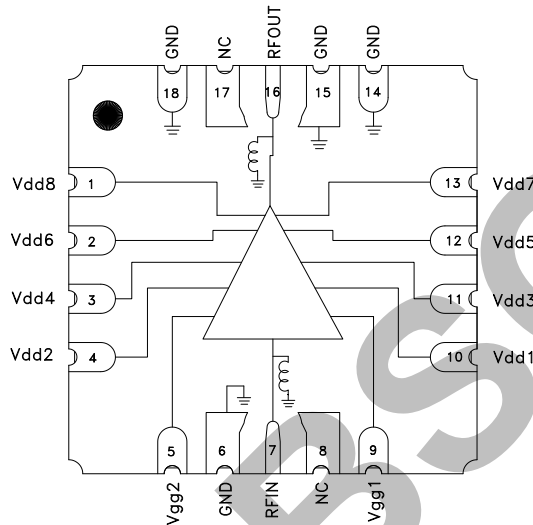

General Description

The HMC5879LS7 is a 4 stage GaAs pHEMT MMIC 4 Watt Power Amplifier which operates between 12 and 16 GHz. The HMC5879LS7 provides 28 dB of gain, +37 dBm of saturated output power, and 22% PAE from a +7V supply. The HMC5879LS7 exhibits excellent linearity and is optimized for high capacity digital microwave radio. It is also ideal for 13.75 to 14.5 GHz Ku Band VSAT transmitters as well as SATCOM applications.

Electrical Specifications

$T_A = +25^\circ\text{C}$, Vdd1, 2, 3, 4, 5, 6, 7, 8 = +7V, Idd = 2400mA^[1]

Parameter	Min.	Typ.	Max.	Units
Frequency Range		12-16		GHz
Gain	24	27		dB
Gain Variation Over Temperature		0.06		dB/ °C
Input Return Loss		13		dB
Output Return Loss		13		dB
Output Power for 1 dB Compression (P1dB)	34.5	36		dBm
Saturated Output Power (P _{sat})		37		dBm
Output Third Order Intercept (IP ₃) ^[2]		44		dBm
Total Supply Current (I _{dd})		2400		mA

[1] Adjust Vgg between -2 to 0V to achieve I_{dd} = 2400mA typical.

[2] Measurement taken at +7V @ 2400mA, P_{out} / Tone = +22 dBm

GaAs pHEMT MMIC 4 WATT POWER AMPLIFIER, 12 - 16 GHz

Broadband Gain & Return Loss vs. Frequency

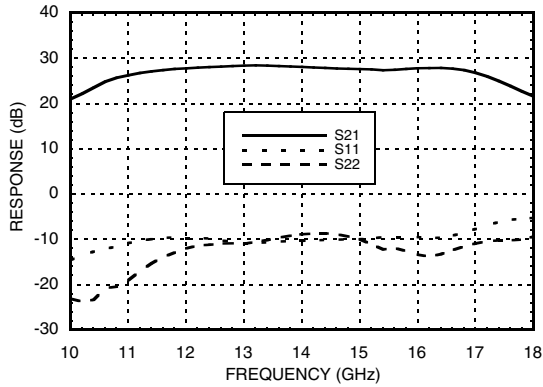

Gain vs. Temperature

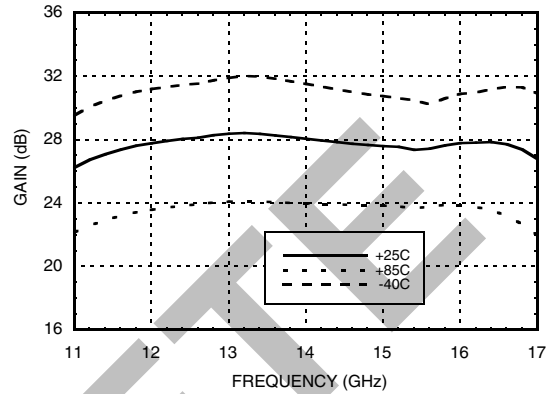

Input Return Loss vs. Temperature

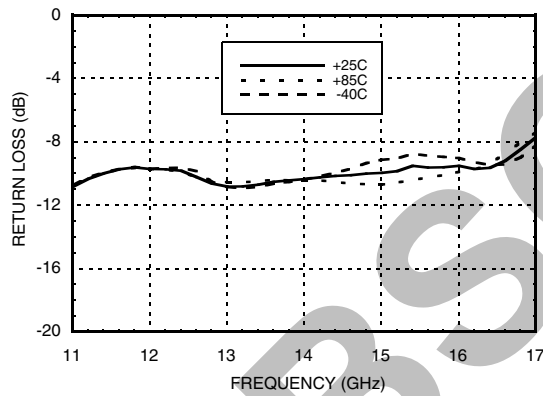

Output Return Loss vs. Temperature

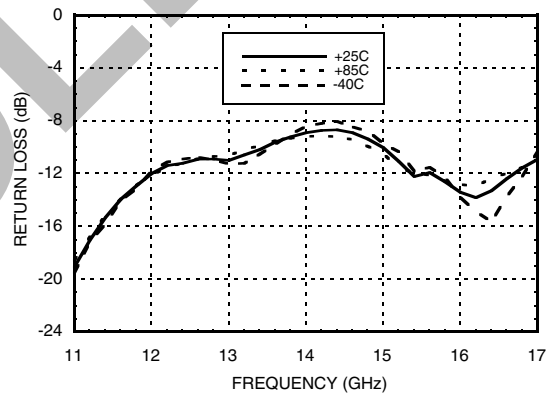

P1dB vs. Temperature

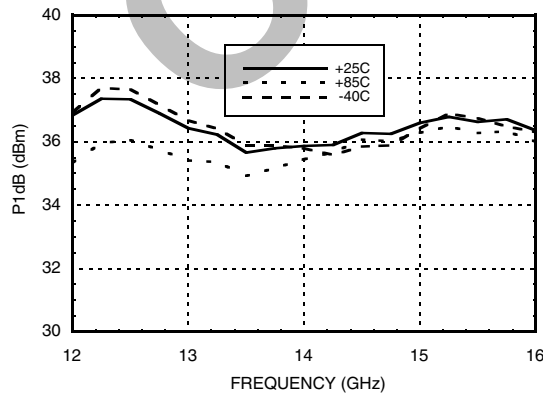

P1dB vs. Supply Voltage

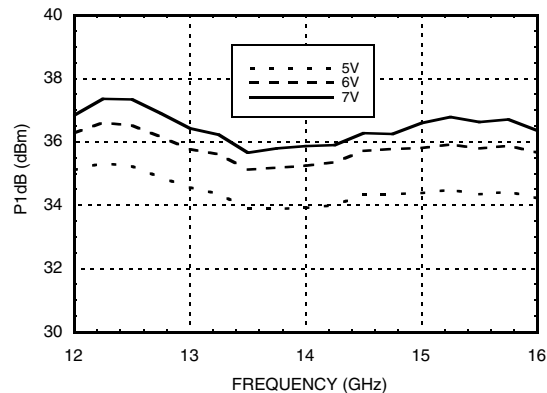

GaAs pHEMT MMIC 4 WATT POWER AMPLIFIER, 12 - 16 GHz

Psat vs. Temperature

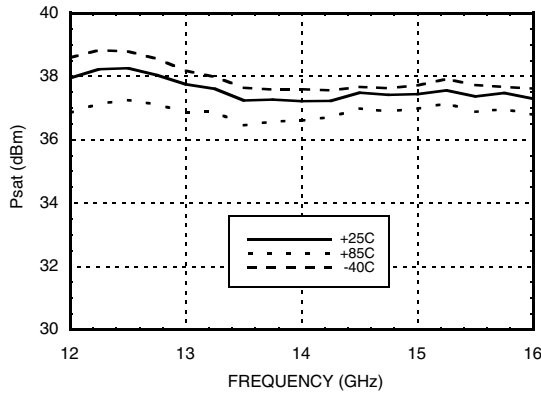

Psat vs. Supply Voltage

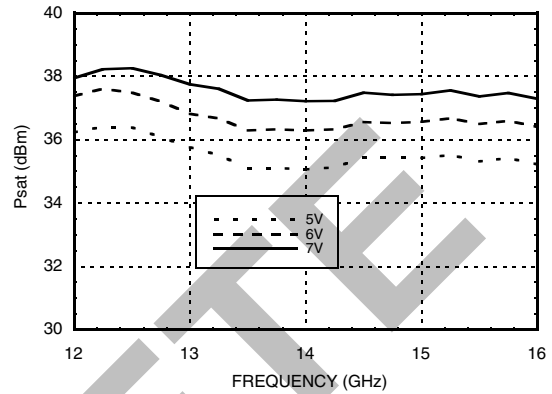

P1dB vs. Supply Current (Idd)

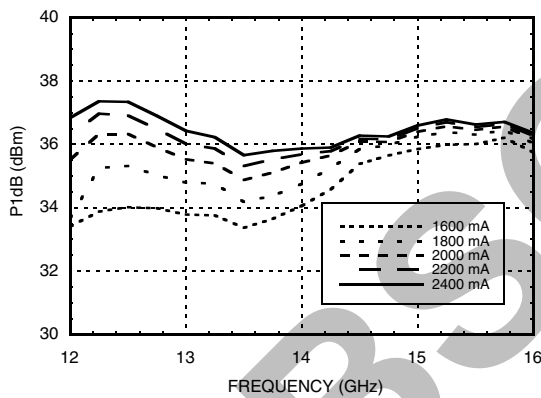

Psat vs. Supply Current (Idd)

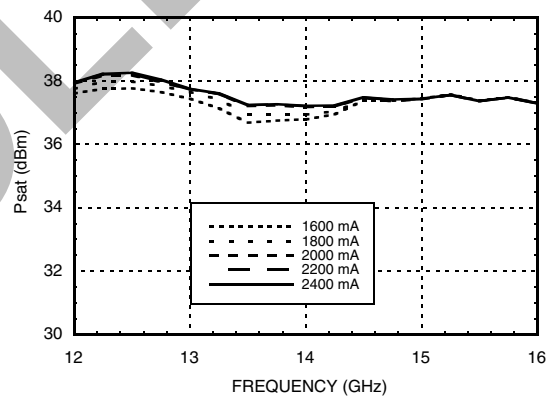

Output IP3 vs. Temperature, Pout/Tone = +22 dBm

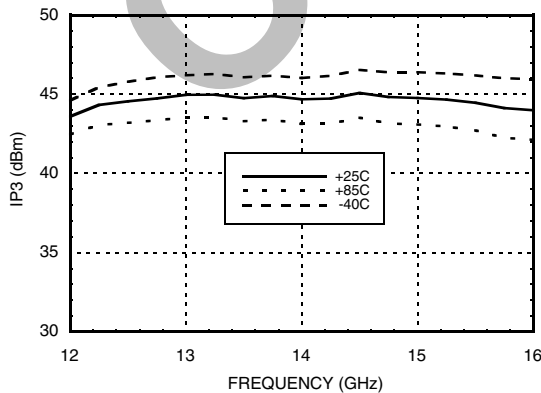

Output IP3 vs. Supply Current, Pout/Tone = +22 dBm

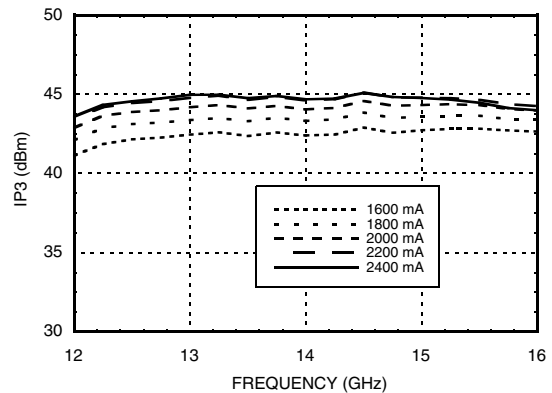

GaAs pHEMT MMIC 4 WATT POWER AMPLIFIER, 12 - 16 GHz

Output IP3 vs. Supply Voltage, Pout/Tone = +22 dBm

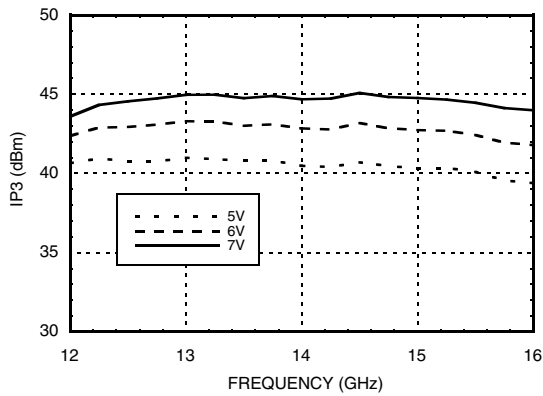

Output IM3 @ Vdd = +5V

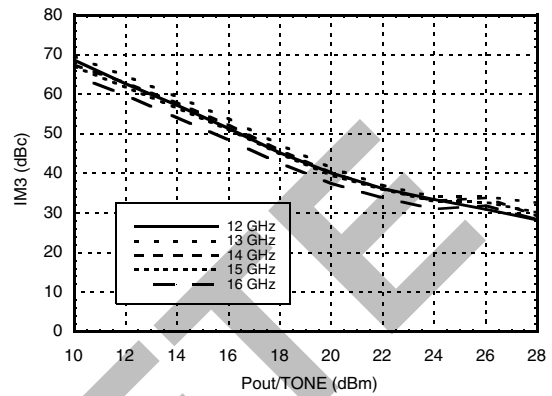

Output IM3 @ Vdd = +6V

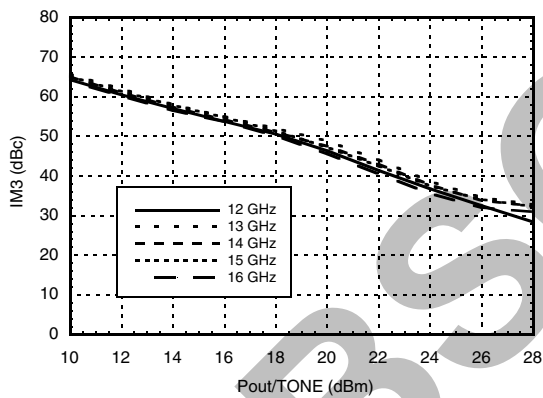

Output IM3 @ Vdd = +7V

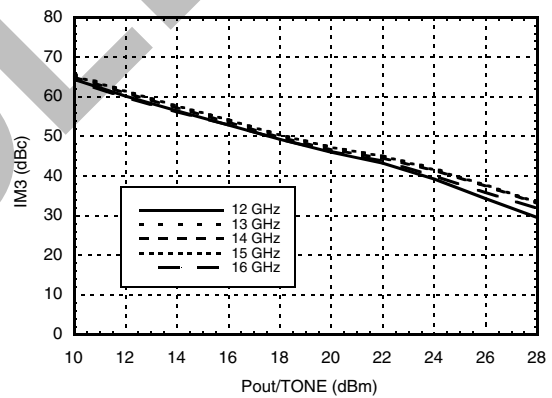

Power Compression @ 13 GHz

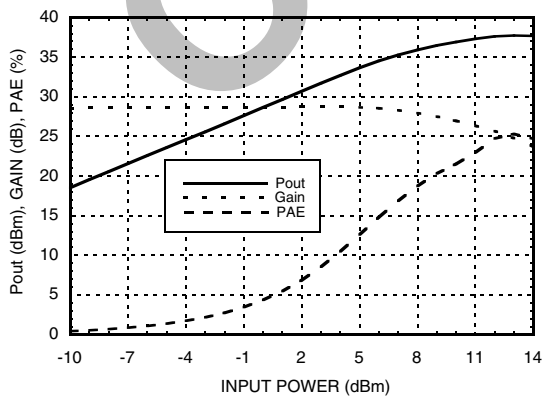

Power Compression @ 14 GHz

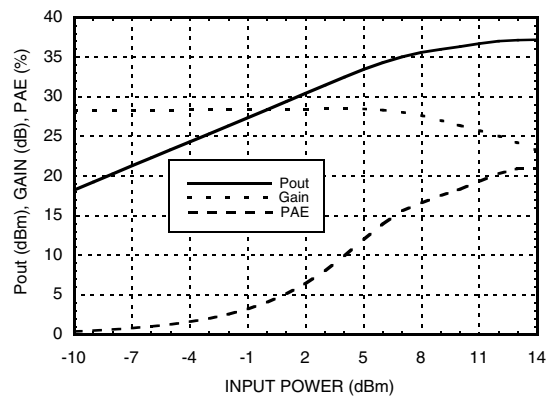

GaAs pHEMT MMIC 4 WATT POWER AMPLIFIER, 12 - 16 GHz

Power Compression @ 15 GHz

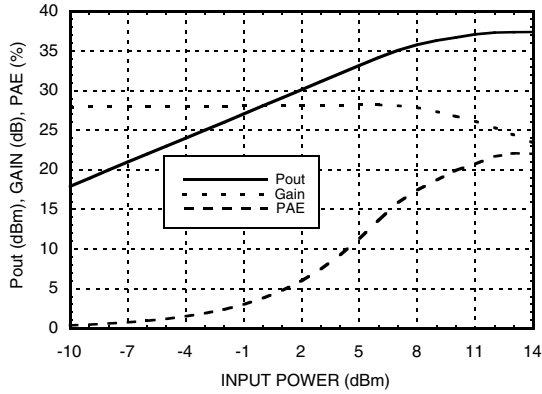

Reverse Isolation vs. Temperature

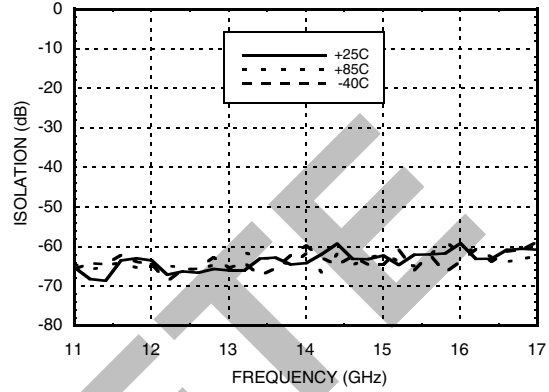

Gain & Power vs. Supply Current @ 14 GHz

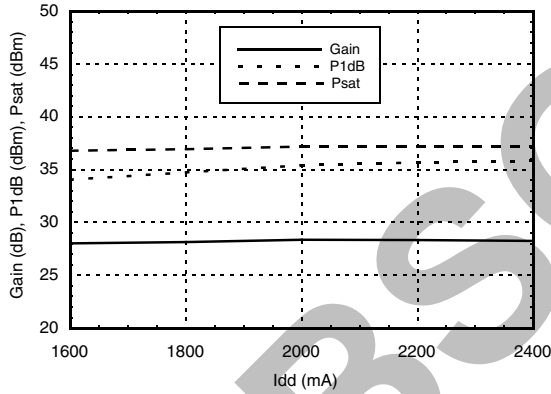

Gain & Power vs. Supply Voltage @ 14 GHz

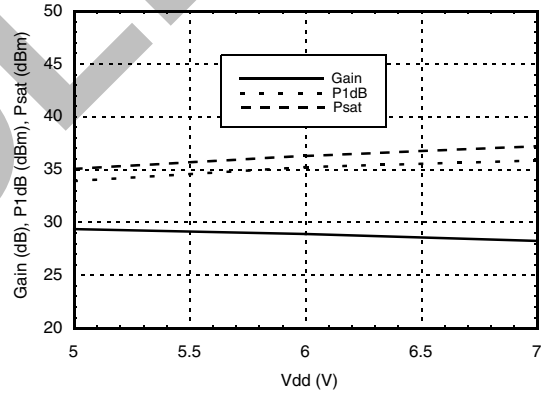

Power Dissipation

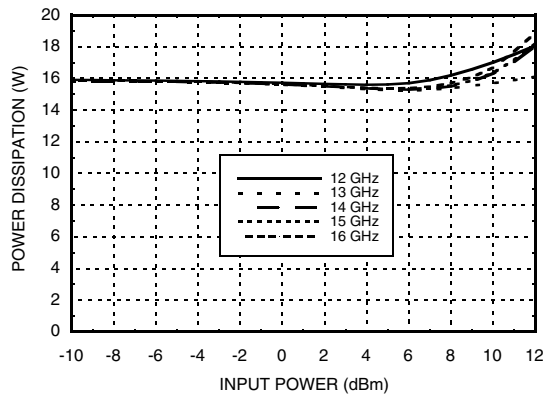

GaAs pHEMT MMIC 4 WATT POWER AMPLIFIER, 12 - 16 GHz

Absolute Maximum Ratings

Drain Bias Voltage (Vdd1 - Vdd8)	+8V
Gate Bias Voltage (Vgg1, Vgg2)	-3V to 0V
RF Input Power (RFIN)	+27 dBm
Channel Temperature	150 °C
Continuous Pdiss (T= 85 °C) (derate 280 mW/°C above 85 °C)	18.20 W
Thermal Resistance (channel to ground paddle)	3.57 °C/W
Storage Temperature	-65 to +150 °C
Operating Temperature	-55 to +85 °C
ESD Sensitivity (HBM)	Class 0, passed 150V

Typical Supply Current vs. Vdd

Vdd (V)	Idd (mA)
+5.0	2400
+6.0	2400
+7.0	2400

Note: Amplifier will operate over full voltage ranges shown above. Vgg adjusted to achieve Idd = 2400 mA.



**ELECTROSTATIC SENSITIVE DEVICE
OBSERVE HANDLING PRECAUTIONS**

Outline Drawing

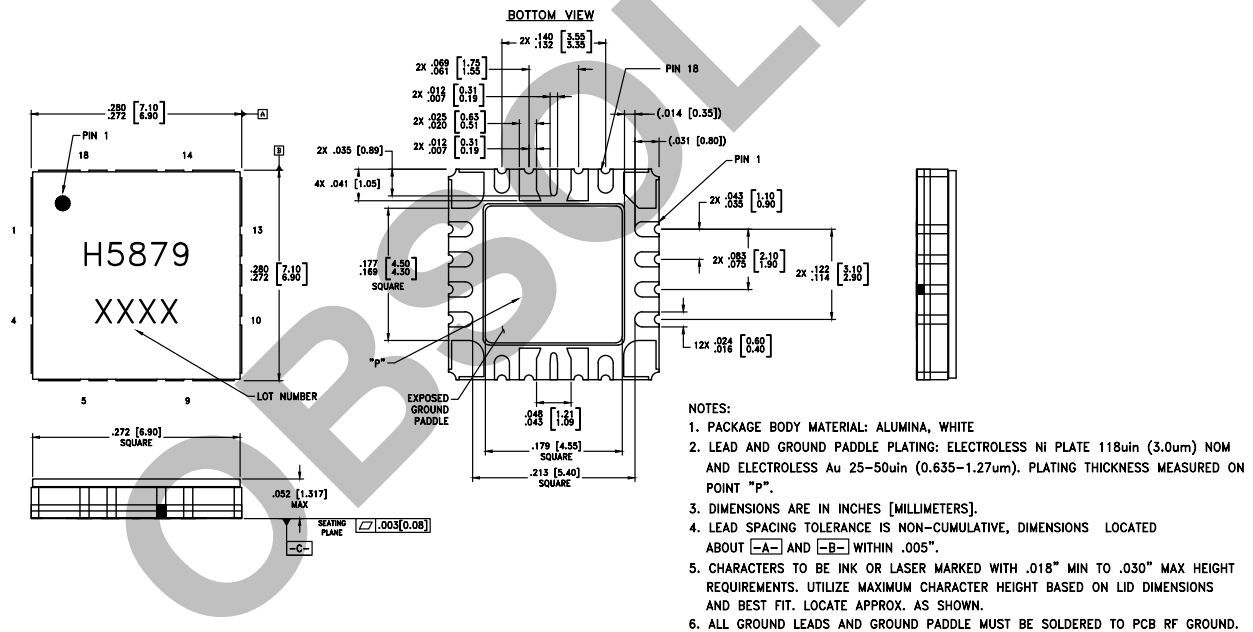

Package Information

Part Number	Package Body Material	Lead Finish	MSL Rating	Package Marking
HMC5879LS7	ALUMINA, WHITE	Gold over Nickel	MSL3	H5879 XXXX

GaAs pHEMT MMIC 4 WATT POWER AMPLIFIER, 12 - 16 GHz

Pin Descriptions

Pin Number	Function	Description	Interface Schematic
1-4 10-13	Vdd8, Vdd6 Vdd4, Vdd2 Vdd1, Vdd3 Vdd5, Vdd7	Drain bias for the amplifier. External bypass capacitors of 100pF, 0.01uF, and 4.7uF are required.	
5, 9	Vgg1, Vgg2	Gate control for amplifier. External bypass capacitors of 100pF, 0.01uF, and 4.7uF are required. The pins are connected to each other internally. Either pin 5 or pin 9 can be used for gate bias.	
6, 14, 15, 18	GND	These pins and the exposed ground paddle must be connected to RF/DC ground.	
7	RFIN	This pin is DC coupled and matched to 50 Ohms over the operating frequency range.	
8, 17	N/C	These pins are not connected internally; however all data shown herein was measured with these pins connected to RF/DC ground externally.	
16	RFOUT	This pin is DC coupled and matched to 50 Ohms.	

Application Circuit

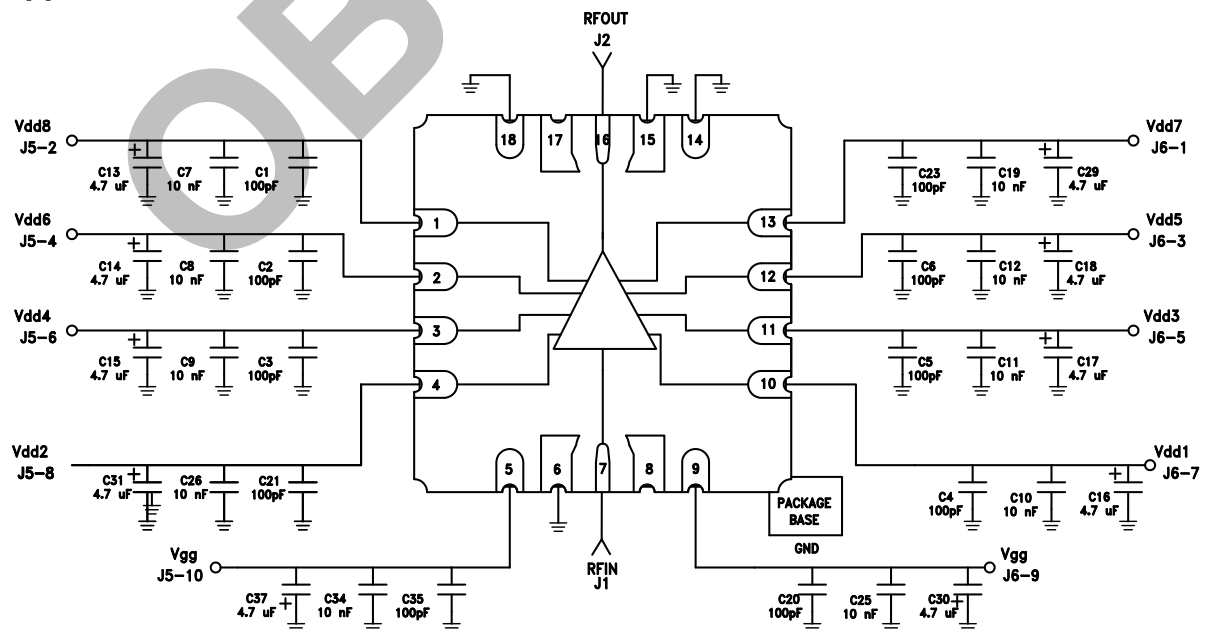

**GaAs pHEMT MMIC 4 WATT
POWER AMPLIFIER, 12 - 16 GHz**

Evaluation PCB

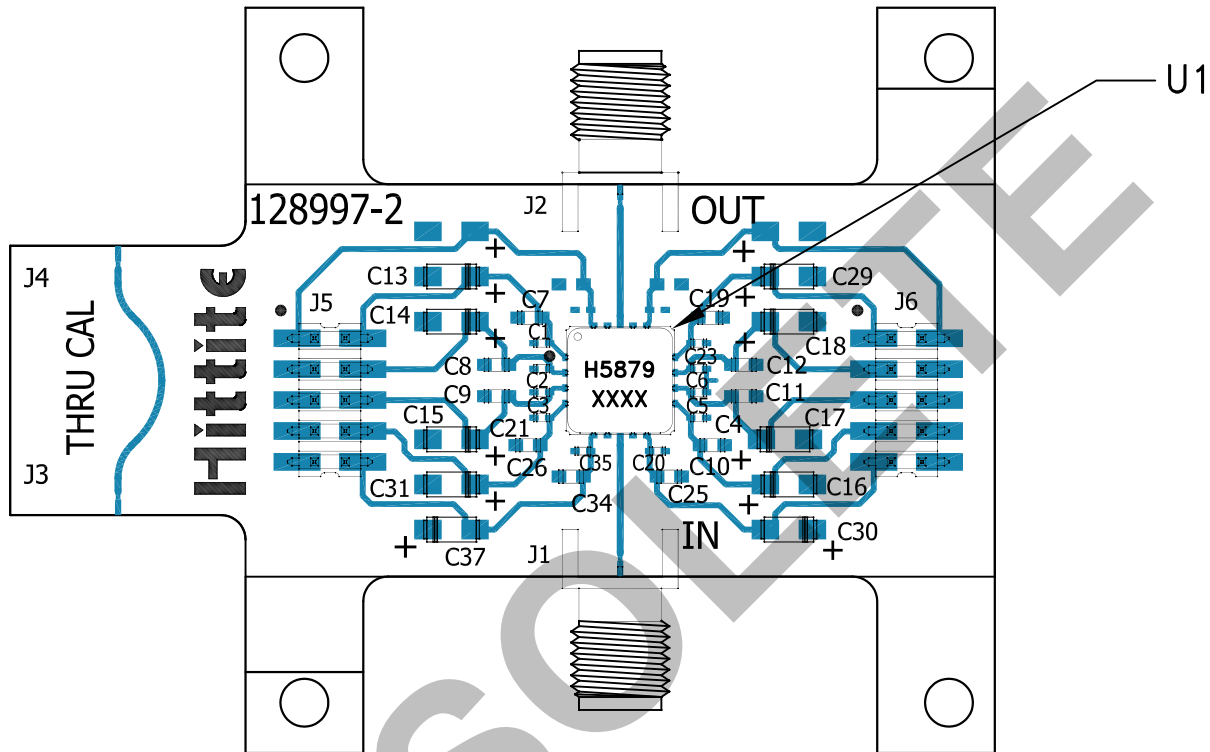

List of Materials for Evaluation PCB EVAL01-HMC5879LS7 [1]

Item	Description
J1, J2	"K" Connector, SRI
J5, J6	DC Pin
C1 - C6, C20, C21, C23, C35	100 pF Capacitor, 0402 Pkg.
C7 - C12, C19, C25, C26, C34	10000 pF Capacitor, 0603 Pkg
C13 - C18, C29 - C30, C31, C37	4.7uF Capacitor, Case A Pkg.
U1	HMC5879LS7 Amplifier
PCB [2]	128997-2 Eval Board

[1] Reference this number when ordering complete evaluation PCB

[2] Circuit Board Material: Rogers 4350

The circuit board used in the application should use RF circuit design techniques. Signal lines should have 50 Ohm impedance while the package ground leads and exposed paddle should be connected directly to the ground plane similar to that shown. A sufficient number of via holes should be used to connect the top and bottom ground planes. The evaluation board should be mounted to an appropriate heat sink. The evaluation circuit board shown is available from Analog Devices, upon request.

X-ON Electronics

Largest Supplier of Electrical and Electronic Components

Click to view similar products for [RF Development Tools](#) category:

Click to view products by [Analog Devices](#) manufacturer:

Other Similar products are found below :

[MAAP-015036-DIEEV2](#) [EV1HMC1113LP5](#) [EV1HMC252AQS24](#) [EV1HMC6146BLC5A](#) [EV1HMC637ALP5](#) [EVAL01-HMC1048LC3B](#)
[EVAL01-HMC661LC4B](#) [EVAL-ADF7020-1DBZ4](#) [EVAL-ADF7020-1DBZ5](#) [EVAL-ADF7020-1DBZ6](#) [EVAL-ADF7020-1DBZ8](#) [EVAL-](#)
[ADF7021DB9Z](#) [EVAL-ADF7021DBJZ](#) [EVAL-ADF7021DBZ2](#) [EVAL-ADF7021DBZ6](#) [EVAL-ADF7021-NDBZ2](#) [EVAL-ADF7021-VDB3Z](#)
[EVAL-ADF7023DB3Z](#) [EVAL-ADF7023-JDB3Z](#) [EVAL-ADF70XXEKZ1](#) [EVAL-ADF7241DB1Z](#) [F0440EVBI](#) [F1241EVBI](#) [F1423EVB-DI](#)
[F1423EVB-SI](#) [F1701EVBI](#) [F1751EVBI](#) [F2250EVBI](#) [MICRF219A-433 EV](#) [122410-HMC686LP4E](#) [AD6679-500EBZ](#) [126223-](#)
[HMC789ST89E](#) [ADL5363-EVALZ](#) [ADL5369-EVALZ](#) [130437-HMC1010LP4E](#) [131352-HMC1021LP4E](#) [131372-HMC951LP4E](#) [130436-](#)
[HMC1010LP4E](#) [DEMOBOARD-U2790B](#) [ATR2406-PNQW](#) [EKIT01-HMC1197LP7F](#) [Si4705-D60-EVB](#) [Si4835-Demo](#) [LMV228SDEVAL](#)
[SKYA21001-EVB](#) [SMP1331-08-EVB](#) [EV1HMC618ALP3](#) [EV1HMC641ALC4](#) [EV1HMC8410LP2F](#) [EVAL_PAN4555ETU](#)