

## FEATURES

**High saturated output power ( $P_{SAT}$ ): 40.5 dBm typical**

**High small signal gain: 18.5 dB typical**

**High power added efficiency (PAE): 69% typical**

**Instantaneous bandwidth: 0.01 GHz to 1.1 GHz**

**Supply voltage:  $V_{DD} = 28\text{ V}$  at 100 mA**

**Internal prematching**

**Simple and compact external tuning for optimal performance**

**32-lead, 5 mm × 5 mm, LFCSP package: 25 mm<sup>2</sup>**

## APPLICATIONS

**Extended battery operation for public mobile radios**

**Power amplifier stage for wireless infrastructures**

**Test and measurement equipment**

**Commercial and military radars**

**General-purpose transmitter amplification**

## GENERAL DESCRIPTION

The **HMC1099** is a gallium nitride (GaN), broadband power amplifier delivering >10 W with up to 69% PAE across an instantaneous bandwidth of 0.01 GHz to 1.1 GHz, and with a  $\pm 0.5$  dB typical gain flatness.

The **HMC1099** is ideal for pulsed or continuous wave (CW) applications, such as wireless infrastructure, radars, public mobile radios, and general-purpose amplification.

The **HMC1099** amplifier is externally tuned using low cost, surface-mount components and is available in a compact LFCSP package.

Multifunction pin names may be referenced by their relevant function only.

## FUNCTIONAL BLOCK DIAGRAM

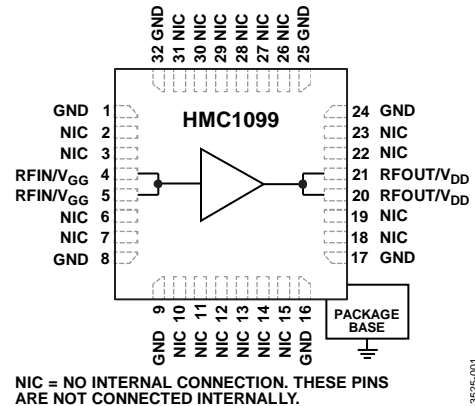

## TABLE OF CONTENTS

Features .....	1	Interface Schematics .....	6
Applications.....	1	Typical Performance Characteristics .....	7
General Description .....	1	Theory of Operation .....	13
Functional Block Diagram .....	1	Applications Information .....	14
Revision History .....	2	Typical Application Circuit.....	14
Specifications.....	3	Evaluation PCB.....	15
Electrical Specifications.....	3	Bill of Materials.....	15
Total Supply Current by $V_{DD}$ .....	4	Outline Dimensions .....	16
Absolute Maximum Ratings.....	5	Ordering Guide .....	16
ESD Caution.....	5		
Pin Configuration and Function Descriptions.....	6		

## REVISION HISTORY

### 12/2016—Rev. 0 to Rev. A

Changed HCP-32-2 to CG-32-1 .....	Throughout
Updated Outline Dimensions .....	16
Changes to Ordering Guide .....	16

### 1/2016—Revision 0: Initial Version

## SPECIFICATIONS

### ELECTRICAL SPECIFICATIONS

$T_A = 25^\circ\text{C}$ ,  $V_{DD} = 28\text{ V}$ ,  $I_{DD} = 100\text{ mA}$ , frequency range = 0.01 GHz to 0.4 GHz.

Table 1.

Parameter	Symbol	Min	Typ	Max	Unit	Test Conditions/Comments
FREQUENCY RANGE		0.01		0.4	GHz	
GAIN						
Small Signal Gain		18	20		dB	
Gain Flatness			$\pm 1$		dB	
RETURN LOSS						
Input			12		dB	
Output			15		dB	
POWER						
Output Power for 4 dB Compression	P4dB		40		dBm	>10 W saturated output power
Power Gain for P4dB Compression			15		dB	
Saturated Output Power	$P_{SAT}$		40.5		dBm	
Power Gain for $P_{SAT}$			13		dB	
Power Added Efficiency	PAE		73		%	
OUTPUT THIRD-ORDER INTERCEPT	IP3		49		dBm	Measurement taken at $P_{OUT}/\text{tone} = 30\text{ dBm}$
NOISE FIGURE			8		dB	
TOTAL SUPPLY CURRENT	$I_{DD}$		100		mA	Adjust the gate bias control voltage ( $V_{GG}$ ) between $-8\text{ V}$ to $0\text{ V}$ to achieve an $I_{DD} = 100\text{ mA}$ typical

$T_A = 25^\circ\text{C}$ ,  $V_{DD} = 28\text{ V}$ ,  $I_{DD} = 100\text{ mA}$ , frequency range = 0.4 GHz to 0.7 GHz.

Table 2.

Parameter	Symbol	Min	Typ	Max	Unit	Test Conditions/Comments
FREQUENCY RANGE		0.4		0.7	GHz	
GAIN						
Small Signal Gain		16.5	18.5		dB	
Gain Flatness			$\pm 0.25$		dB	
RETURN LOSS						
Input			9.5		dB	
Output			14		dB	
POWER						
Output Power for 4 dB Compression	P4dB		40.5		dBm	>10 W saturated output power
Power Gain for P4dB Compression			14		dB	
Saturated Output Power	$P_{SAT}$		40.5		dBm	
Power Gain for $P_{SAT}$			13		dB	
Power Added Efficiency	PAE		69		%	
OUTPUT THIRD-ORDER INTERCEPT	IP3		48		dBm	Measurement taken at $P_{OUT}/\text{tone} = 30\text{ dBm}$
NOISE FIGURE			5.5		dB	
TOTAL SUPPLY CURRENT	$I_{DD}$		100		mA	Adjust the gate bias control voltage ( $V_{GG}$ ) between $-8\text{ V}$ to $0\text{ V}$ to achieve an $I_{DD} = 100\text{ mA}$ typical

$T_A = 25^\circ\text{C}$ ,  $V_{DD} = 28\text{ V}$ ,  $I_{DD} = 100\text{ mA}$ , frequency range = 0.7 GHz to 1.1 GHz.

Table 3.

Parameter	Symbol	Min	Typ	Max	Unit	Test Conditions/Comments
FREQUENCY RANGE		0.7		1.1	GHz	
GAIN						
Small Signal Gain		16.5	18.5		dB	
Gain Flatness			$\pm 0.5$		dB	
RETURN LOSS						
Input			12		dB	
Output			17		dB	
POWER						
Output Power for 4 dB Compression	P4dB		41.5		dBm	>10 W saturated output power
Power Gain for P4dB Compression			14		dB	
Saturated Output Power	$P_{SAT}$		41.5		dBm	
Power Gain for $P_{SAT}$			13.5		dB	
Power Added Efficiency	PAE		69		%	
OUTPUT THIRD-ORDER INTERCEPT	IP3		47		dBm	Measurement taken at $P_{OUT}/\text{tone} = 30\text{ dBm}$
NOISE FIGURE			5		dB	
TOTAL SUPPLY CURRENT	$I_{DD}$		100		mA	Adjust the gate bias control voltage ( $V_{GG}$ ) between $-8\text{ V}$ to $0\text{ V}$ to achieve an $I_{DD} = 100\text{ mA}$ typical

### TOTAL SUPPLY CURRENT BY $V_{DD}$

Table 4.

Parameter	Symbol	Min	Typ	Max	Unit	Test Conditions/Comments
SUPPLY CURRENT	$I_{DD}$					Adjust the gate bias control voltage ( $V_{GG}$ ) between $-8\text{ V}$ to $0\text{ V}$ to achieve an $I_{DD} = 100\text{ mA}$ typical
$V_{DD} = 24\text{ V}$			100		mA	
$V_{DD} = 28\text{ V}$			100		mA	

## ABSOLUTE MAXIMUM RATINGS

Table 5.

Parameter <sup>1</sup>	Rating
Drain Bias Voltage ( $V_{DD}$ )	32 V dc
Gate Bias Voltage ( $V_{GG}$ )	-8 V to 0 V dc
Radio Frequency (RF) Input Power (RFIN)	33 dBm
Maximum Forward Gate Current	4 mA
Maximum Voltage Standing Wave Ratio (VSWR) <sup>2</sup>	6:1
Channel Temperature	225°C
Maximum Peak Reflow Temperature (MSL3) <sup>3</sup>	260°C
Continuous Power Dissipation, $P_{DISS}$ ( $T_A = 85^\circ\text{C}$ , Derate 89 mW/°C Above 85°C)	12.5 W
Thermal Resistance (Junction to Back of Paddle)	11.2°C/W
Storage Temperature Range	-55°C to +150°C
Operating Temperature Range	-40°C to +85°C
ESD Sensitivity (Human Body Model)	Class 1B, passed 500 V

<sup>1</sup> When referring to a single function of a multifunction pin in the parameters, only the portion of the pin name that is relevant to the Absolute Maximum Rating is listed. For full pin names of multifunction pins, refer to the Pin Configuration and Function Descriptions section.

<sup>2</sup> Restricted by maximum power dissipation.

<sup>3</sup> See the Ordering Guide for additional information.

Stresses at or above those listed under Absolute Maximum Ratings may cause permanent damage to the product. This is a stress rating only; functional operation of the product at these or any other conditions above those indicated in the operational section of this specification is not implied. Operation beyond the maximum operating conditions for extended periods may affect product reliability.

### ESD CAUTION



**ESD (electrostatic discharge) sensitive device.** Charged devices and circuit boards can discharge without detection. Although this product features patented or proprietary protection circuitry, damage may occur on devices subjected to high energy ESD. Therefore, proper ESD precautions should be taken to avoid performance degradation or loss of functionality.

# PIN CONFIGURATION AND FUNCTION DESCRIPTIONS

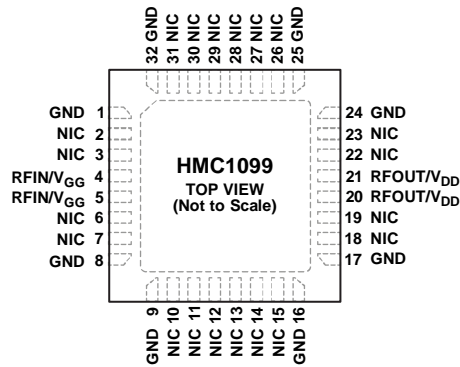

- NOTES
1. EXPOSED PAD. EXPOSED PAD MUST BE CONNECTED TO RF/DC GROUND.
  2. NO INTERNAL CONNECTION. THESE PINS ARE NOT CONNECTED INTERNALLY.

13525-002

Figure 2. Pin Configuration

Table 6. Pad Function Descriptions

Pin No.	Mnemonic	Description
1, 8, 9, 16, 17, 24, 25, 32	GND	Ground. These pins must be connected to RF/dc ground. See Figure 3 for the GND interface schematic.
2, 3, 6, 7, 10 to 15, 18, 19, 22, 23, 26 to 31	NIC	No Internal Connection. These pins are not connected internally. However, all data was measured with these pins connected to RF/dc ground externally.
4, 5	RFIN/V <sub>GG</sub>	RF Input (RFIN)/Gate Bias Control Voltage (V <sub>GG</sub> ). This pin is a multifunction pin. The RFIN/V <sub>GG</sub> pin is dc-coupled with internal prematching and requires external matching to 50 Ω, as shown in Figure 38. See Figure 4 for the RFIN/V <sub>GG</sub> interface schematic.
20, 21	RFOUT/V <sub>DD</sub>	RF Output (RFOUT)/Drain Bias Voltage (V <sub>DD</sub> ). This is a multifunction pin. The RFOUT/V <sub>DD</sub> pin is dc-coupled and requires external matching to 50 Ω, as shown in Figure 38. See Figure 4 for the RFOUT/V <sub>DD</sub> interface schematic.
	EPAD	Exposed Pad. The exposed pad must be connected to RF/dc ground.

## INTERFACE SCHEMATICS



Figure 3. GND Interface

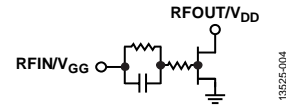

Figure 4. RFIN/V<sub>GG</sub> and RFOUT/V<sub>DD</sub> Interface

### TYPICAL PERFORMANCE CHARACTERISTICS

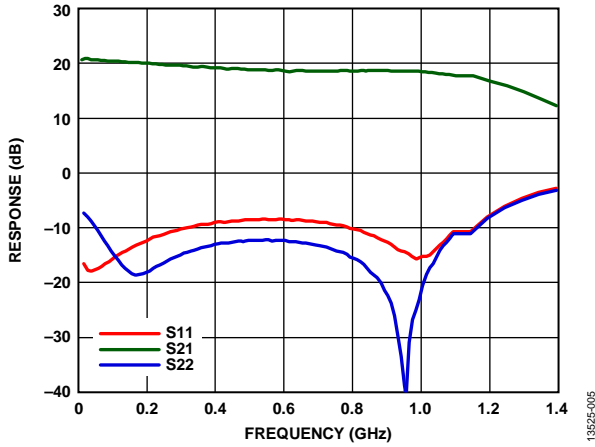

Figure 5. Response (Gain and Return Loss) vs. Frequency

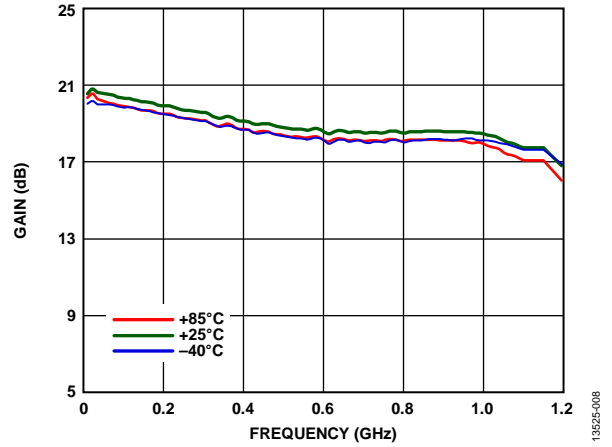

Figure 8. Gain vs. Frequency at Various Temperatures

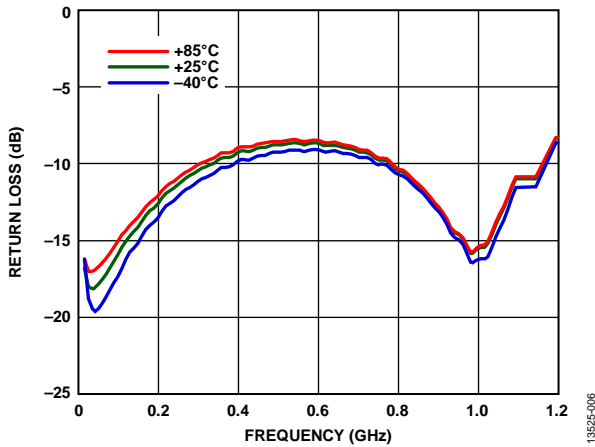

Figure 6. Input Return Loss vs. Frequency at Various Temperatures

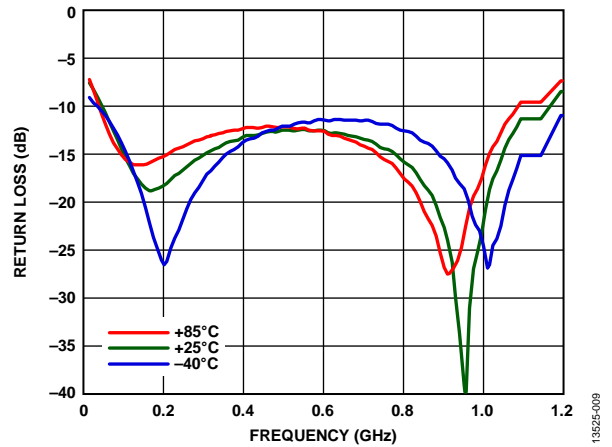

Figure 9. Output Return Loss vs. Frequency at Various Temperatures

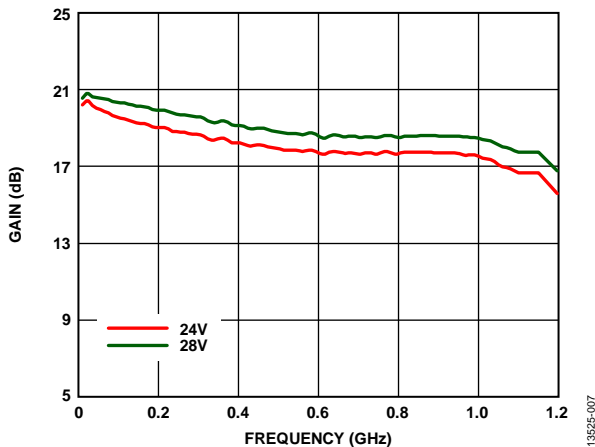

Figure 7. Gain vs. Frequency at Various Supply Voltages

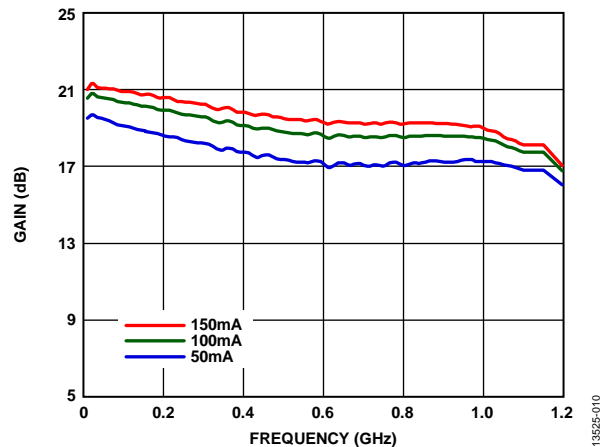

Figure 10. Gain vs. Frequency at Various Supply Currents

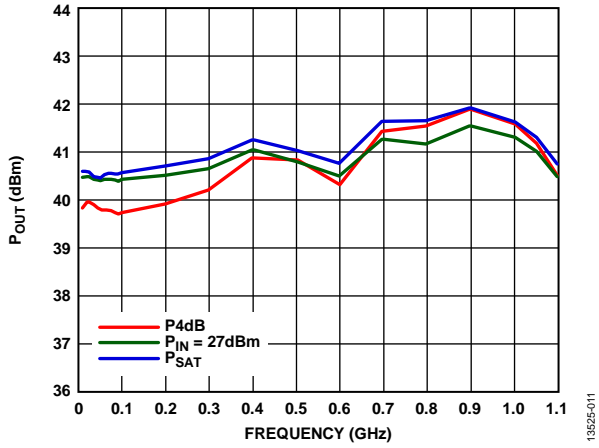

Figure 11. Power Output ( $P_{OUT}$ ) vs. Frequency

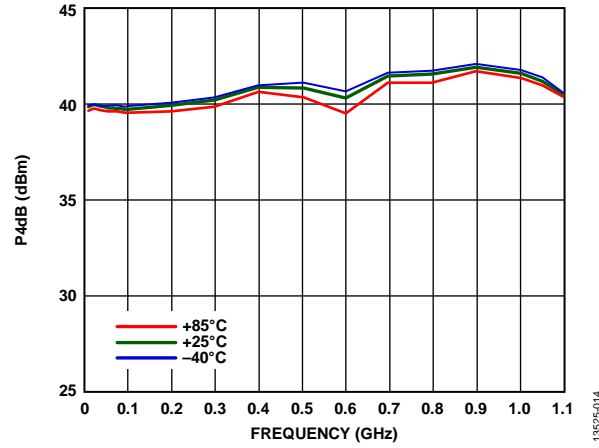

Figure 14. Output Power for 4 dB Compression ( $P_{4dB}$ ) vs. Frequency at Various Temperatures

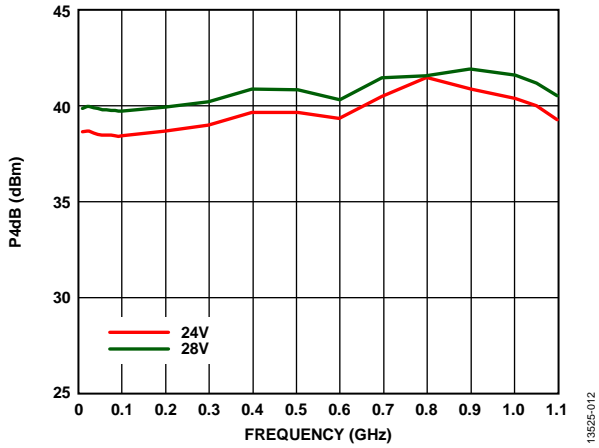

Figure 12. Output Power for 4 dB Compression ( $P_{4dB}$ ) vs. Frequency at Various Supply Voltages

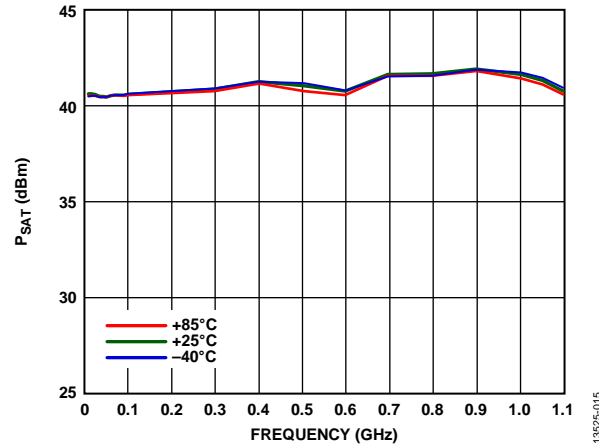

Figure 15. Saturated Output Power ( $P_{SAT}$ ) vs. Frequency at Various Temperatures

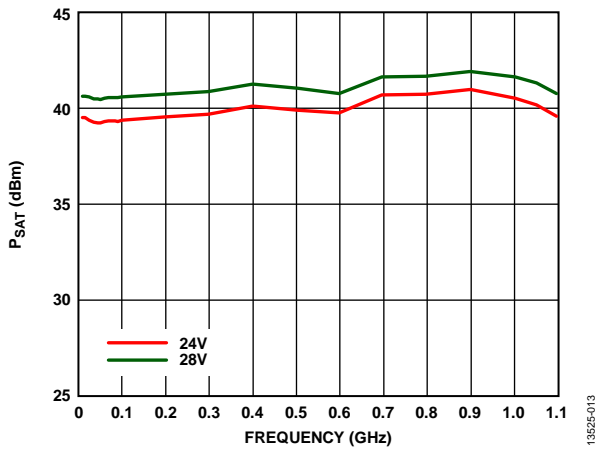

Figure 13. Saturated Output Power ( $P_{SAT}$ ) vs. Frequency at Various Supply Voltages

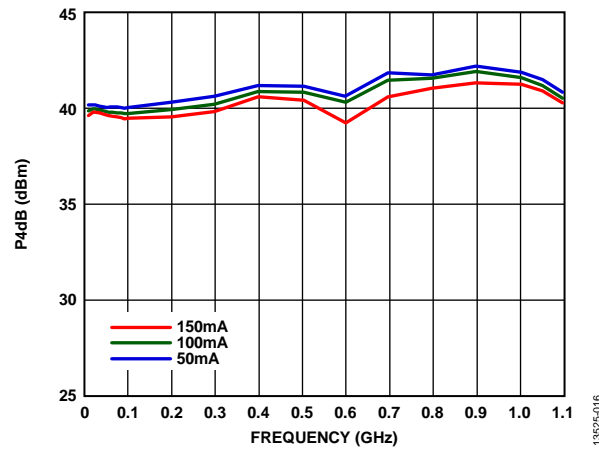

Figure 16. Output Power for 4 dB Compression ( $P_{4dB}$ ) vs. Frequency at Various Supply Currents



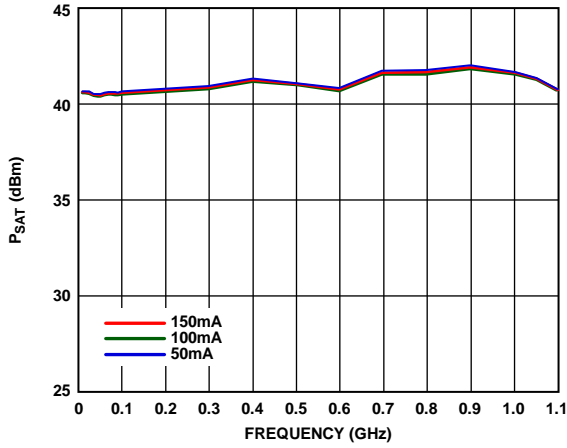

Figure 17. Saturated Output Power ( $P_{SAT}$ ) vs. Frequency at Various Supply Currents

13525-017

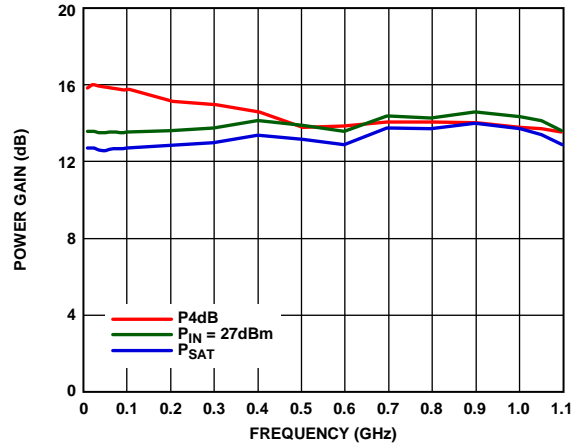

Figure 20. Power Gain vs. Frequency

13525-020

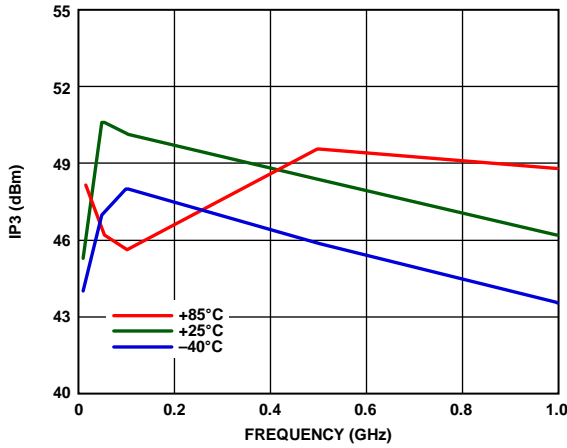

Figure 18. Output Third-Order Intercept ( $IP3$ ) vs. Frequency at Various Temperatures,  $P_{OUT}/Tone = 30 dBm$

13525-018

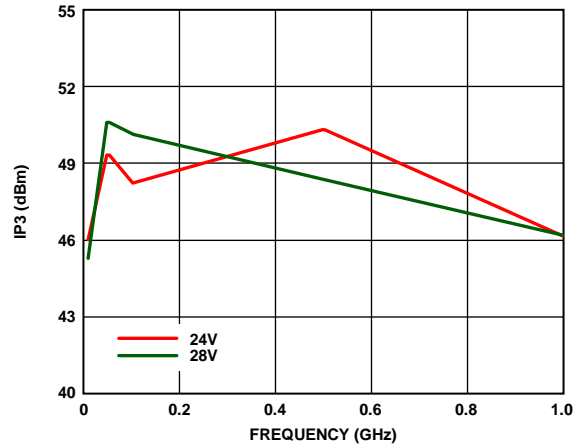

Figure 21. Output Third-Order Intercept ( $IP3$ ) vs. Frequency at Various Supply Voltages,  $P_{OUT}/Tone = 30 dBm$

13525-021

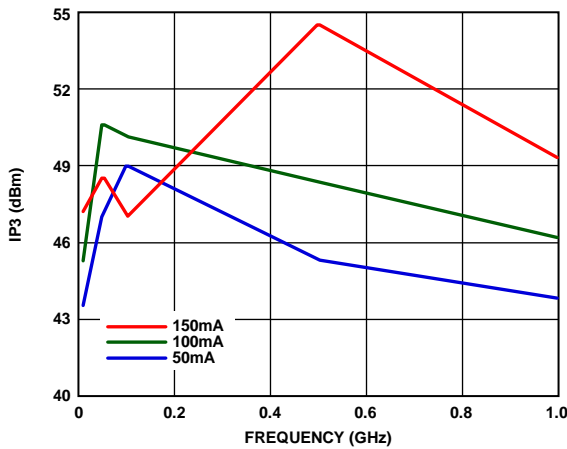

Figure 19. Output Third-Order Intercept ( $IP3$ ) vs. Frequency at Various Supply Currents,  $P_{OUT}/Tone = 30 dB$

13525-019

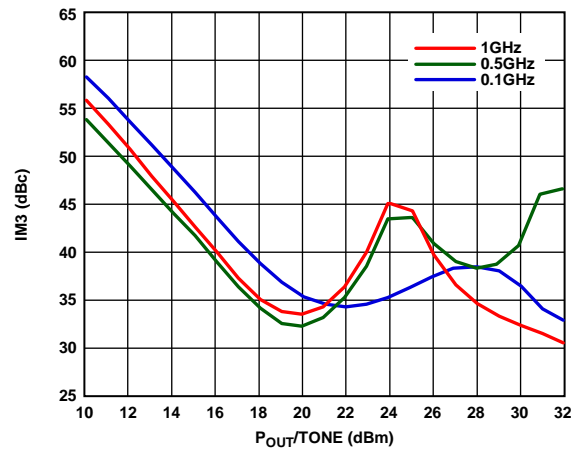

Figure 22. Output Third-Order Intermodulation ( $IM3$ ) vs.  $P_{OUT}/TONE$  at  $V_{DD} = 24 V$

13525-022

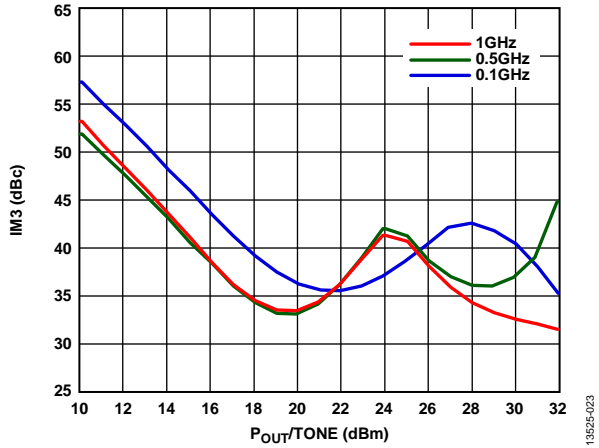

Figure 23. Output Third-Order Intermodulation (IM3) vs.  $P_{OUT}/TONE$  at  $V_{DD} = 28 V$

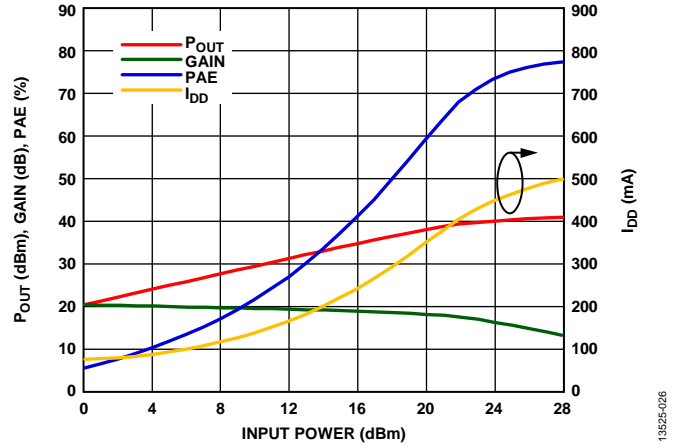

Figure 26. Power Output ( $P_{OUT}$ ), GAIN, Power Added Efficiency (PAE), and Total Supply Current ( $I_{DD}$ ) vs. Input Power at 0.1 GHz

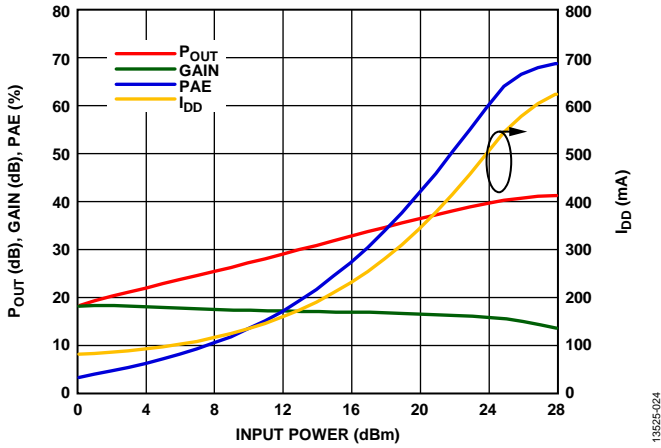

Figure 24. Power Output ( $P_{OUT}$ ), GAIN, Power Added Efficiency (PAE), and Total Supply Current ( $I_{DD}$ ) vs. Input Power at 0.5 GHz

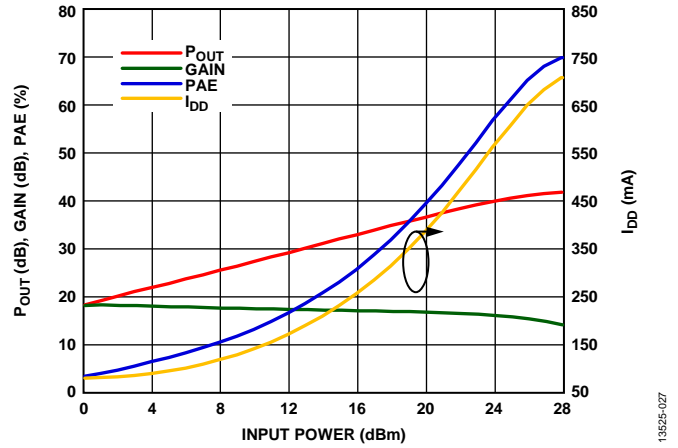

Figure 27. Power Output ( $P_{OUT}$ ), GAIN, Power Added Efficiency (PAE), and Total Supply Current ( $I_{DD}$ ) vs. Input Power at 1 GHz

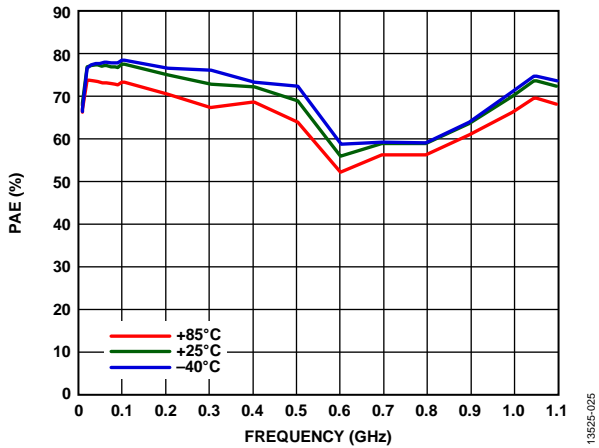

Figure 25. Power Added Efficiency (PAE) vs. Frequency at Various Temperatures

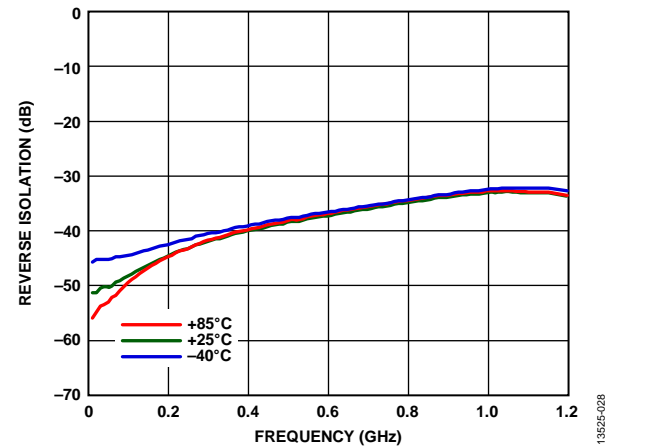

Figure 28. Reverse Isolation vs. Frequency at Various Temperatures

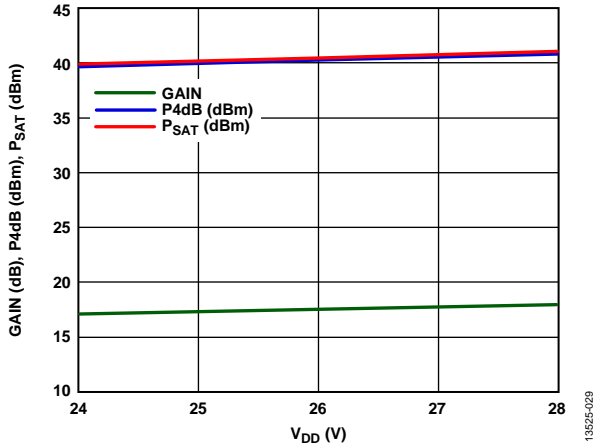

Figure 29. Gain, Output Power for 4 dB Compression (P4dB), and Saturated Output Power (PSAT) vs. Supply Voltage (VDD) at 0.5 GHz

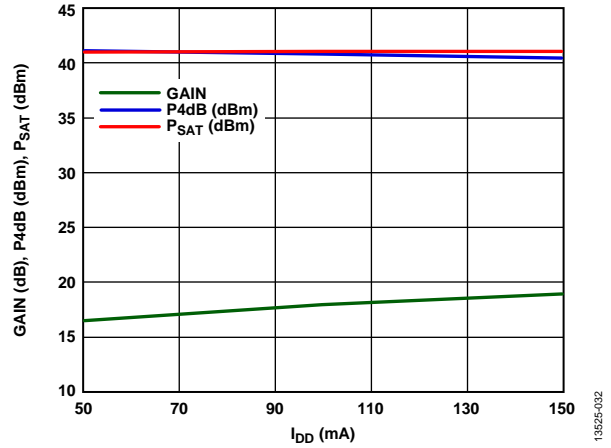

Figure 32. Gain, Output Power for 4 dB Compression (P4dB), and Saturated Output Power (PSAT) vs. Supply Current (IDD) at 0.5 GHz

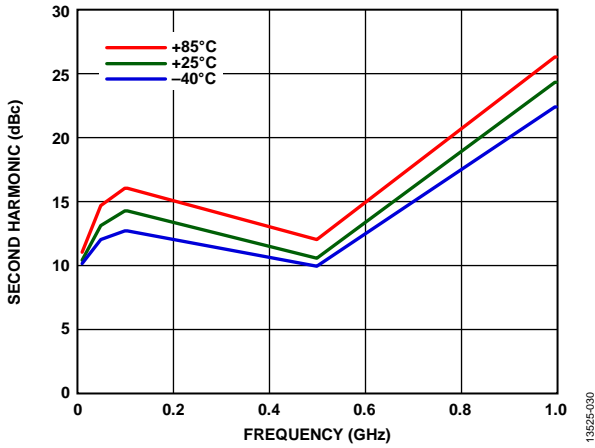

Figure 30. Second Harmonic vs. Frequency at Various Temperatures

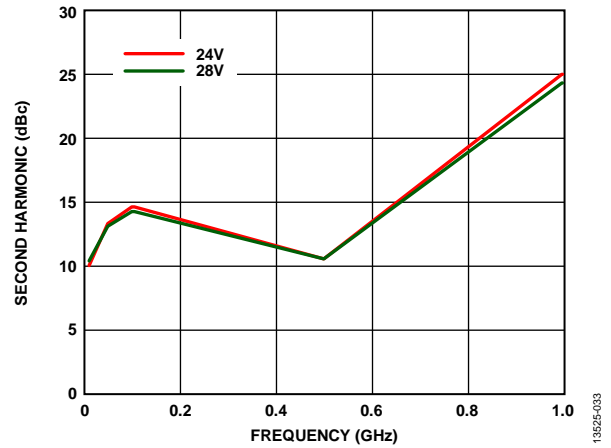

Figure 33. Second Harmonic vs. Frequency at Various Supply Voltages

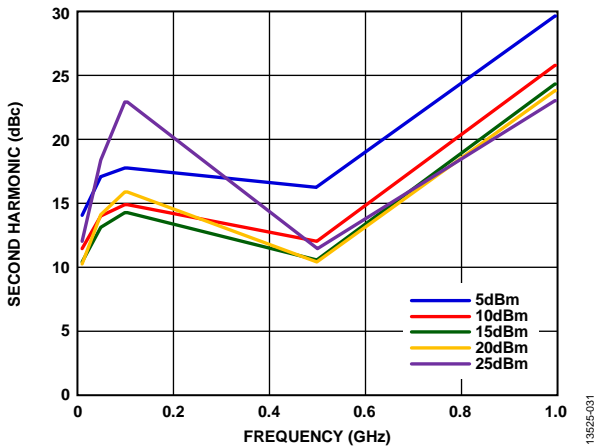

Figure 31. Second Harmonic vs. Frequency at Various Input Power Levels

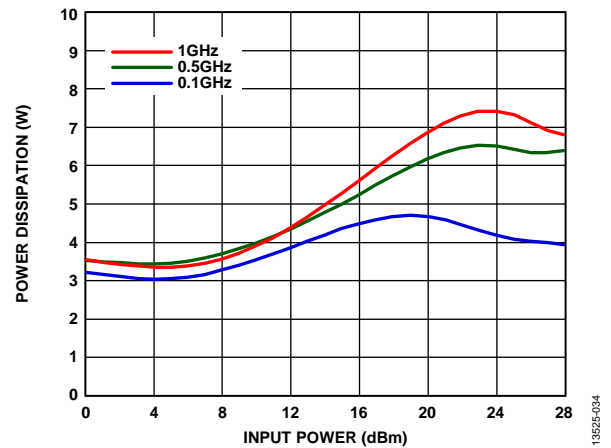

Figure 34. Power Dissipation vs. Input Power at Various Frequencies

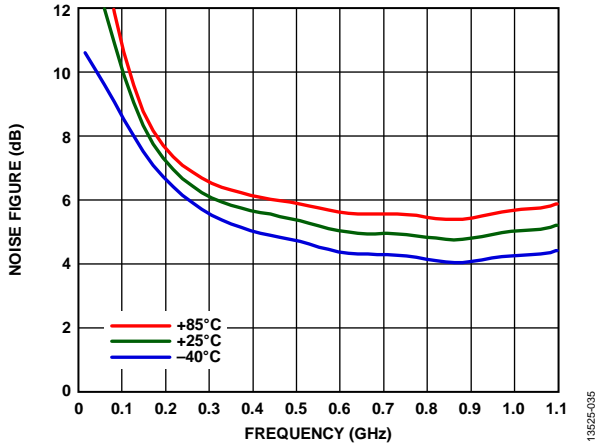

Figure 35. Noise Figure vs. Frequency at Various Temperatures

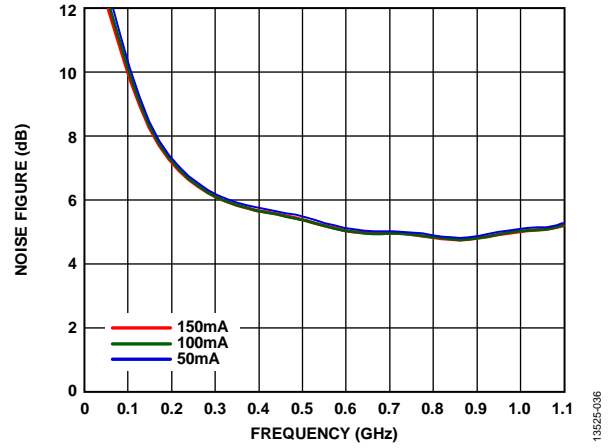

Figure 37. Noise Figure vs. Frequency at Various Supply Currents

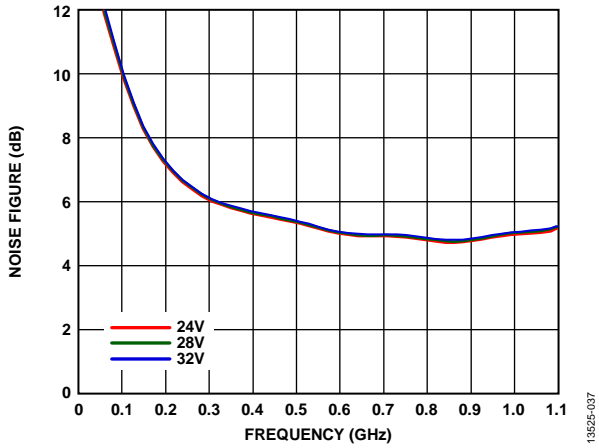

Figure 36. Noise Figure vs. Frequency at Various Supply Voltages

## THEORY OF OPERATION

The HMC1099 is a >10 W, gallium nitride (GaN), power amplifier that consists of a single gain stage that effectively operates like a single field effect transistor (FET). The device is internally prematched so that a simple, external matching network optimizes the performance across the entire operating

frequency range. The recommended dc bias conditions put the device in deep Class AB operation, resulting in high saturated output power (40.5 dBm typical) at improved levels of power efficiency (69% typical).

## APPLICATIONS INFORMATION

The drain bias voltage is applied through the RFOUT/ $V_{DD}$  pin, and the gate bias voltage is applied through the RFIN/ $V_{GG}$  pin. For operation of a single application circuit across the entire frequency range, it is recommended to use the external matching components specified in the typical application circuit (L1, C1, L3, and C8) shown in Figure 38. If operation is only required across a narrower frequency range, performance may be optimized additionally through the implementation of alternate matching networks. Capacitive bypassing of  $V_{DD}$  and  $V_{GG}$  is recommended.

The recommended power-up bias sequence follows:

1. Connect to the GND pin.
2. Set  $V_{GG}$  to  $-8$  V to pinch off the drain current.
3. Set  $V_{DD}$  to 28 V (drain current is pinched off).
4. Adjust  $V_{GG}$  more positive (approximately  $-2.5$  V to  $-3.0$  V) until a quiescent of  $I_{DD} = 100$  mA is obtained.
5. Apply the RF signal.

The recommended power-down bias sequence follows:

1. Turn off the RF signal.
2. Set  $V_{GG}$  to  $-8$  V to pinch off the drain current.
3. Set  $V_{DD}$  to 0 V.
4. Set  $V_{GG}$  to 0 V.

All measurements for this device were taken using the typical application circuit, configured as shown in the assembly diagram (see Figure 38). The bias conditions shown in the electrical specifications table (see Table 1 to Table 3) are the operating points recommended to optimize the overall performance. Unless otherwise noted, the data shown was taken using the recommended bias conditions. Operation of the [HMC1099](#) under other bias conditions may provide performance that differs from what is shown in the Typical Performance Characteristics section.

The evaluation printed circuit board (PCB) provides the [HMC1099](#) in its typical application circuit, allowing easy operation using standard dc power supplies and 50  $\Omega$  RF test equipment.

## TYPICAL APPLICATION CIRCUIT

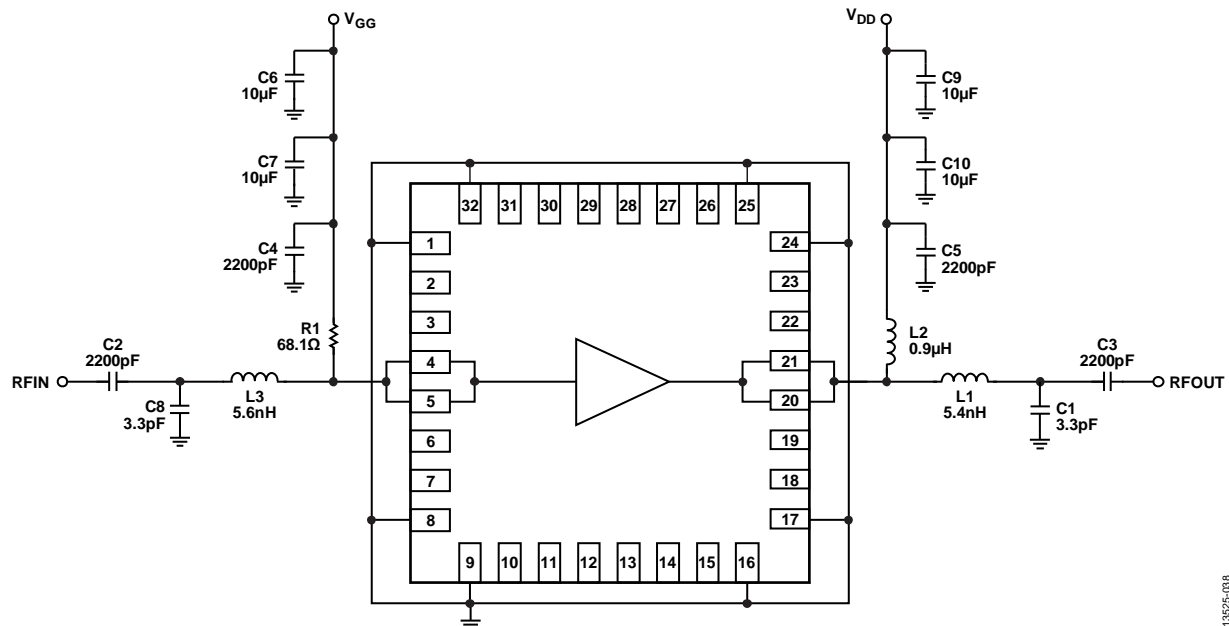

Figure 38. Typical Application Circuit

13525-03B

**EVALUATION PCB**

Use RF circuit design techniques for the circuit board used in the application. Provide 50 Ω impedance for the signal lines and directly connect the package ground leads and exposed paddle to the ground plane, similar to that shown in Figure 39. Use a

sufficient number of via holes to connect the top and bottom ground planes. The evaluation circuit board shown in Figure 39 is available from Analog Devices, Inc., upon request.

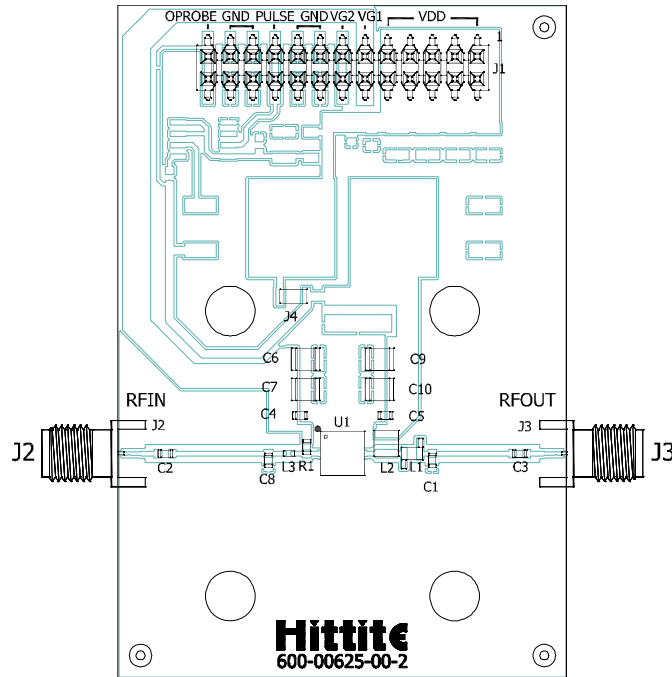

Figure 39. Evaluation Printed Circuit Board

**BILL OF MATERIALS**

Table 7. Bill of Materials for Evaluation PCB EV1HMC1099LP5D

Item	Description
J2, J3	SMA connectors
J1	DC pin
J4	Preform jumper
C1, C8	3.3 pF capacitors, 0603 package
C2 to C5	2200 pF capacitors, 0603 package
C6, C7, C9, C10	10 μF capacitors, 1210 package
L1	5.4 nH inductor, 0906 package
L2	0.9 μH inductor, 1008 package
L3	5.6 nH inductor, 0402 package
R1	68.1 Ω resistor, 0603 package
U1	<a href="#">HMC1099LP5DE</a>
PCB	600-00625-00-2 evaluation PCB, circuit board material: Rogers 4350 or Arlon 25FR

OUTLINE DIMENSIONS

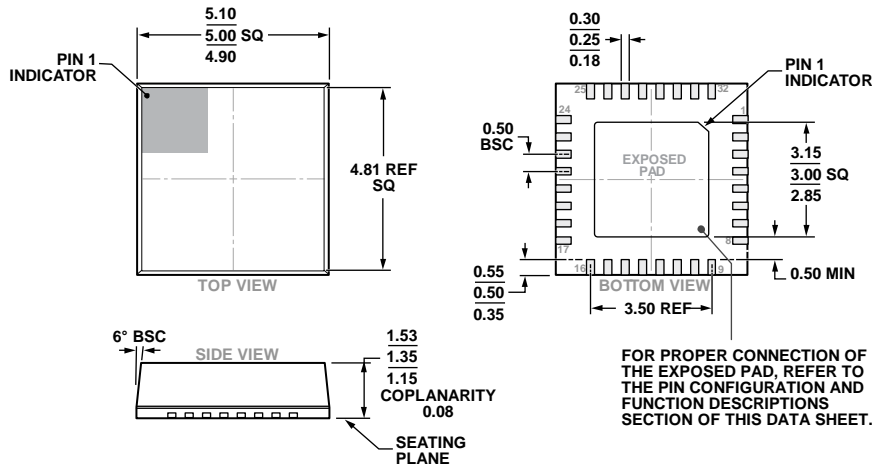

Figure 40. 32-Lead Lead Frame Chip Scale Package, Premolded Cavity [LFCSP\_CAV]  
 5 mm x 5 mm Body and 1.34 mm Package Height  
 (CG-32-1)  
 Dimensions shown in millimeters

ORDERING GUIDE

Model <sup>1,2</sup>	Temperature	MSL Rating <sup>3</sup>	Description <sup>4</sup>	Package Option	Branding <sup>5</sup>
HMC1099LP5DE	-40°C to +85°C	MSL3	32-Lead LFCSP_CAV	CG-32-1	H1099 XXXX
HMC1099LP5DETR	-40°C to +85°C	MSL3	32-Lead LFCSP_CAV	CG-32-1	H1099 XXXX
EV1HMC1099LP5D			Evaluation PCB		

<sup>1</sup> The HMC1099LP5DE and the HMC1099LP5DETR are LFCSP premolded copper alloy lead frame and RoHS Compliant.  
<sup>2</sup> When ordering the evaluation board only, reference the model number, EV1HMC1099LP5D.  
<sup>3</sup> See the Absolute Maximum Ratings section for additional information.  
<sup>4</sup> The lead finish of the HMC1099LP5DE and the HMC1099LP5DETR are nickel palladium gold (NiPdAu).  
<sup>5</sup> The 4-digit lot number for the HMC1099LP5DE and the HMC1099LP5DETR are represented by XXXX.



## X-ON Electronics

Largest Supplier of Electrical and Electronic Components

*Click to view similar products for [RF Amplifier](#) category:*

*Click to view products by [Analog Devices](#) manufacturer:*

Other Similar products are found below :

[A82-1](#) [BGA622H6820XTSA1](#) [BGA 728L7 E6327](#) [BGB719N7ESDE6327XTMA1](#) [HMC397-SX](#) [HMC405](#) [HMC561-SX](#) [HMC8120-SX](#)  
[HMC8121-SX](#) [HMC-ALH382-SX](#) [HMC-ALH476-SX](#) [SE2433T-R](#) [SMA3101-TL-E](#) [SMA39](#) [A66-1](#) [A66-3](#) [A67-1](#) [A81-2](#) [LX5535LQ](#)  
[LX5540LL](#) [MAAM02350](#) [HMC3653LP3BETR](#) [HMC549MS8GETR](#) [HMC-ALH435-SX](#) [SMA101](#) [SMA32](#) [SMA411](#) [SMA531](#)  
[SST12LP19E-QX6E](#) [WPM0510A](#) [HMC5929LS6TR](#) [HMC5879LS7TR](#) [HMC1087F10](#) [HMC1086](#) [HMC1016](#) [SMA1212](#) [MAX2689EWS+T](#)  
[MAAMSS0041TR](#) [MAAM37000-A1G](#) [LTC6430AIUF-15#PBF](#) [SMA70-2](#) [SMA4011](#) [A231](#) [HMC-AUH232](#) [LX5511LQ](#) [LX5511LQ-TR](#)  
[HMC7441-SX](#) [HMC-ALH310](#) [XD1001-BD-000V](#) [A4011](#)