

## FEATURES

- Output power for 1 dB compression (P1dB): 12.5 dBm typical at 8 GHz to 30 GHz**
- Saturated output power (P<sub>SAT</sub>): 17.5 dBm typical at 8 GHz to 30 GHz**
- Gain: 14.5 dB typical at 30 GHz to 50 GHz**
- Output third-order intercept (IP3): 23 dBm typical at 8 GHz to 30 GHz**
- Supply voltage: 5 V at 80 mA**
- 50 Ω matched input/output**
- Die size: 2.7 mm × 1.45 mm × 0.1 mm**

## APPLICATIONS

- Test instrumentation
- Microwave radios and VSATs
- Military and space
- Telecommunications infrastructure
- Fiber optics

## GENERAL DESCRIPTION

The [HMC1127](#) is a gallium arsenide (GaAs), pseudomorphic high electron mobility transfer (pHEMT), monolithic microwave integrated circuit (MMIC), distributed power amplifier that operates between 2 GHz and 50 GHz. The [HMC1127](#) provides 14.5 dB of gain, 23 dBm output IP3 and 12.5 dBm of output power at 1 dB gain compression while

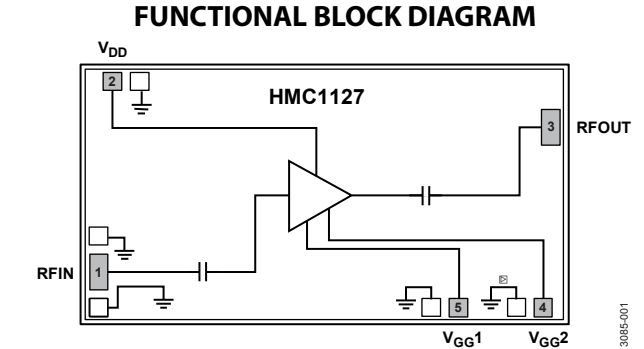

Figure 1.

requiring 80 mA from a 5 V supply. The [HMC1127](#) amplifier inputs/outputs are internally matched to 50 Ω facilitating integration into multichip modules (MCMs). All data is taken with the chip connected via two 0.025 mm (1 mil) wire bonds of minimal length 0.31 mm (12 mils).

## TABLE OF CONTENTS

Features .....	1	ESD Caution.....	5
Applications.....	1	Pin Configuration and Function Descriptions.....	6
Functional Block Diagram .....	1	Interface Schematics .....	7
General Description .....	1	Typical Performance Characteristics .....	8
Revision History .....	2	Applications Information .....	13
Specifications.....	3	Mounting and Bonding Techniques for Millimeterwave GaAs MMICs.....	13
2 GHz to 8 GHz Frequency Range.....	3	Application Circuit.....	15
8 GHz to 30 GHz Frequency Range.....	3	Assembly Diagram .....	15
30 GHz to 40 GHz Frequency Range.....	4	Outline Dimensions .....	16
40 GHz to 50 GHz Frequency Range.....	4	Ordering Guide .....	16
Absolute Maximum Ratings.....	5		

## REVISION HISTORY

### 1/2018—Rev. A to Rev. B

Changes to Figure 1 .....	1
Changes to Figure 4.....	7
Changes to Ordering Guide .....	16

### 5/2015—Rev. 00.1214 to Rev. A

This Hittite Microwave Products data sheet has been reformatted to meet the styles and standards of Analog Devices, Inc.

Updated Format.....	Universal
Changes to Table 5.....	5
Added Applications Information Section and Figure 35;	
Renumbered Sequentially.....	13
Added Ordering Guide Section .....	16

## SPECIFICATIONS

### 2 GHz TO 8 GHz FREQUENCY RANGE

$T_A = +25^\circ\text{C}$ ,  $V_{DD} = +5\text{ V}$ ,  $V_{GG2} = +1.4\text{ V}$ ,  $I_{DD} = 80\text{ mA}$ . Adjust  $V_{GG1}$  between  $-2\text{ V}$  and  $0\text{ V}$  to achieve  $I_{DD} = 80\text{ mA}$  typical.

Table 1.

Parameter	Symbol	Test Conditions/Comments	Min	Typ	Max	Unit
FREQUENCY RANGE			2		8	GHz
GAIN			12	15		dB
Gain Variation Over Temperature				0.005		dB/ $^\circ\text{C}$
RETURN LOSS						
Input				17		dB
Output				10		dB
OUTPUT POWER						
Output Power for 1 dB Compression	P1dB		11	14		dBm
Saturated Output Power	$P_{SAT}$			18.5		dBm
Output Third-Order Intercept	IP3	Measurement taken at $P_{OUT}/\text{tone} = 10\text{ dBm}$		25.5		dBm
NOISE FIGURE				8		dBm
SUPPLY CURRENT	$I_{DD}$	$V_{DD} = 4\text{ V}, V_{DD} = 5\text{ V}, V_{DD} = 6\text{ V}, V_{DD} = 7\text{ V}, \text{ or } V_{DD} = 8\text{ V}$		80		mA

### 8 GHz TO 30 GHz FREQUENCY RANGE

$T_A = +25^\circ\text{C}$ ,  $V_{DD} = +5\text{ V}$ ,  $V_{GG2} = +1.4\text{ V}$ ,  $I_{DD} = 80\text{ mA}$ . Adjust  $V_{GG1}$  between  $-2\text{ V}$  and  $0\text{ V}$  to achieve  $I_{DD} = 80\text{ mA}$  typical.

Table 2.

Parameter	Symbol	Test Conditions/Comments	Min	Typ	Max	Unit
FREQUENCY RANGE			8		30	GHz
GAIN			10.5	13.5		dB
Gain Variation Over Temperature				0.006		dB/ $^\circ\text{C}$
RETURN LOSS						
Input				18		dB
Output				20		dB
OUTPUT POWER						
1 dB Compression (P1dB)	P1dB		9.5	12.5		dBm
Saturated Output Power ( $P_{SAT}$ )	$P_{SAT}$			17.5		dBm
Output Third-Order Intercept	IP3	Measurement taken at $P_{OUT}/\text{tone} = 10\text{ dBm}$		23		dBm
NOISE FIGURE				6.5		dBm
SUPPLY CURRENT	$I_{DD}$	$V_{DD} = 4\text{ V}, V_{DD} = 5\text{ V}, V_{DD} = 6\text{ V}, V_{DD} = 7\text{ V}, \text{ or } V_{DD} = 8\text{ V}$		80		mA

**30 GHz TO 40 GHz FREQUENCY RANGE**

$T_A = +25^\circ\text{C}$ ,  $V_{DD} = +5\text{ V}$ ,  $V_{GG2} = +1.4\text{ V}$ ,  $I_{DD} = 80\text{ mA}$ . Adjust  $V_{GG1}$  between  $-2\text{ V}$  and  $0\text{ V}$  to achieve  $I_{DD} = 80\text{ mA}$  typical.

Table 3.

Parameter	Symbol	Test Conditions/Comments	Min	Typ	Max	Unit
FREQUENCY RANGE			30		40	GHz
GAIN			11.5	14.5		dB
Gain Variation Over Temperature				0.011		dB/ $^\circ\text{C}$
RETURN LOSS						
Input				20		dB
Output				17		dB
OUTPUT POWER						
1 dB Compression (P1dB)	P1dB		9	12		dBm
Saturated Output Power ( $P_{SAT}$ )	$P_{SAT}$			17		dBm
Output Third-Order Intercept	IP3	Measurement taken at $P_{OUT}/\text{tone} = 10\text{ dBm}$		22		dBm
NOISE FIGURE				6		dBm
SUPPLY CURRENT	$I_{DD}$	$V_{DD} = 4\text{ V}, V_{DD} = 5\text{ V}, V_{DD} = 6\text{ V}, V_{DD} = 7\text{ V}, \text{ or } V_{DD} = 8\text{ V}$		80		mA

**40 GHz TO 50 GHz FREQUENCY RANGE**

$T_A = +25^\circ\text{C}$ ,  $V_{DD} = +5\text{ V}$ ,  $V_{GG2} = +1.4\text{ V}$ ,  $I_{DD} = 80\text{ mA}$ . Adjust  $V_{GG1}$  between  $-2\text{ V}$  and  $0\text{ V}$  to achieve  $I_{DD} = 80\text{ mA}$  typical.

Table 4.

Parameter	Symbol	Test Conditions/Comments	Min	Typ	Max	Unit
FREQUENCY RANGE			40		50	GHz
GAIN			11.5	14.5		dB
Gain Variation Over Temperature				0.012		dB/ $^\circ\text{C}$
RETURN LOSS						
Input				13		dB
Output				13		dB
OUTPUT POWER						
1 dB Compression (P1dB)	P1dB		8.5	10.5		dBm
Saturated Output Power ( $P_{SAT}$ )	$P_{SAT}$			15		dBm
Output Third-Order Intercept	IP3	Measurement taken at $P_{OUT}/\text{tone} = 10\text{ dBm}$		18		dBm
NOISE FIGURE				6.5		dBm
SUPPLY CURRENT	$I_{DD}$	$V_{DD} = 4\text{ V}, V_{DD} = 5\text{ V}, V_{DD} = 6\text{ V}, V_{DD} = 7\text{ V}, \text{ or } V_{DD} = 8\text{ V}$		80		mA

## ABSOLUTE MAXIMUM RATINGS

Table 5.

Parameter	Rating
Drain Bias Voltage ( $V_{DD}$ )	8.5 V
Gate Bias Voltage	
$V_{GG1}$	-3 V dc to 0 V dc
$V_{GG2}$	
For $V_{DD} = 8$ V <sup>1</sup>	3.6 V
For $V_{DD} = 7$ V	3.0 V
For $V_{DD} = 6$ V	>2.0 V
For $V_{DD} = 4$ V to 5 V	>1.2 V
RF Input Power (RFIN)	22 dBm
Channel Temperature	175°C
Continuous Power Dissipation, $P_{DISS}$ ( $T_A = 85^\circ\text{C}$ , Derate 26.1 mW/ $^\circ\text{C}$ Above 85°C)	2.53 W
Thermal Resistance, $R_{TH}$ (Channel to Die Bottom)	38.3°C/W <sup>2</sup>
Storage Temperature Range	-65°C to +150°C
Operating Temperature Range	-55°C to +85°C
ESD Sensitivity, Human Body Model (HBM)	Class1A, passed 250 V

<sup>1</sup>  $I_{DD} < 125$  mA.<sup>2</sup> Based on a thermal epoxy of 20 W/ $^\circ\text{C}$ .

Stresses at or above those listed under Absolute Maximum Ratings may cause permanent damage to the product. This is a stress rating only; functional operation of the product at these or any other conditions above those indicated in the operational section of this specification is not implied. Operation beyond the maximum operating conditions for extended periods may affect product reliability.

### ESD CAUTION



#### ESD (electrostatic discharge) sensitive device.

Charged devices and circuit boards can discharge without detection. Although this product features patented or proprietary protection circuitry, damage may occur on devices subjected to high energy ESD. Therefore, proper ESD precautions should be taken to avoid performance degradation or loss of functionality.

## PIN CONFIGURATION AND FUNCTION DESCRIPTIONS

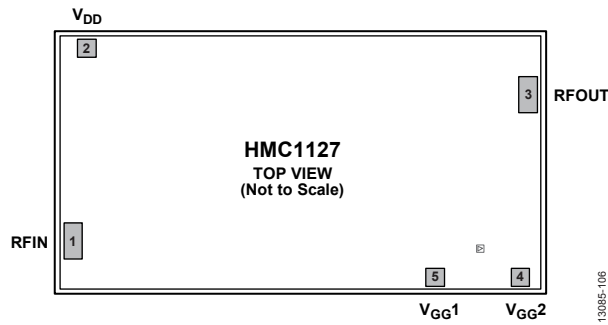

Figure 2. Pad Configuration

Table 6. Pad Function Descriptions

Pad No.	Mnemonic	Description
1	RFIN	RF Input. This pin is ac-coupled and matched to 50 Ω.
2	V <sub>DD</sub>	Power Supply Voltage for the Amplifier, with Integrated RF Choke. Connect dc bias to this pad to provide drain current (I <sub>DD</sub> ).
3	RFOUT	RF Output. This pin is ac-coupled and matched to 50 Ω.
4	V <sub>GG2</sub>	Gate Control 2 for Amplifier. Attach bypass capacitors as shown in Figure 38. For nominal operation, apply 1.4 V to V <sub>GG2</sub> .
5	V <sub>GG1</sub>	Gate Control 1 for Amplifier. Attach bypass capacitors as shown in Figure 38. Adjust this pad to achieve I <sub>DD</sub> = 80 mA.
Die Bottom	GND	Die bottom must be connected to RF/dc ground.

**INTERFACE SCHEMATICS**

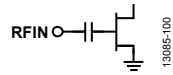

Figure 3. RFIN Interface Schematic

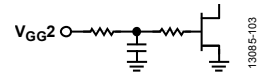

Figure 6. VGG2 Interface Schematic

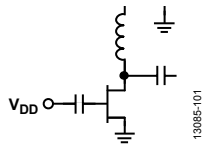

Figure 4. VDD Interface Schematic

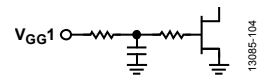

Figure 7. VGG1 Interface Schematic

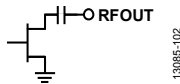

Figure 5. RFOUT Interface Schematic



Figure 8. GND Interface Schematic

TYPICAL PERFORMANCE CHARACTERISTICS

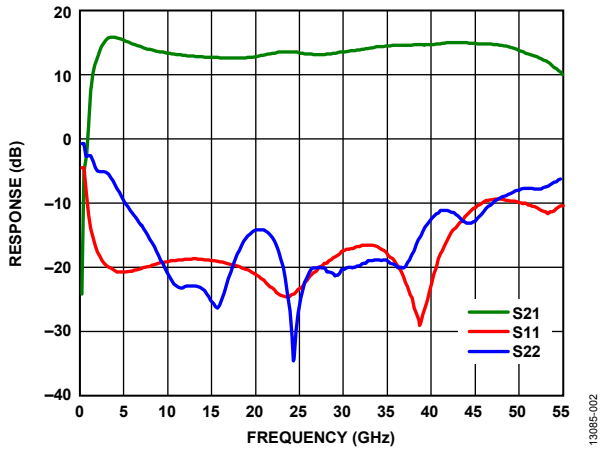

Figure 9. Response (Gain and Return Loss) vs. Frequency

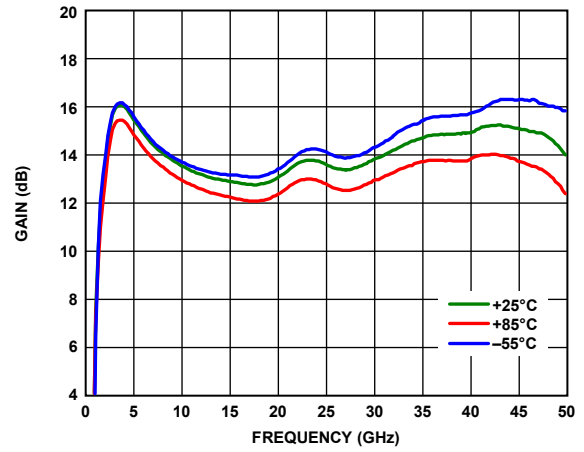

Figure 12. Gain vs. Frequency at Various Temperatures

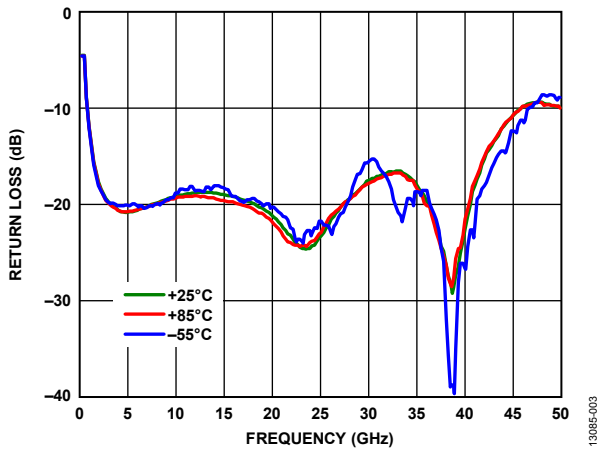

Figure 10. Input Return Loss vs. Frequency at Various Temperatures

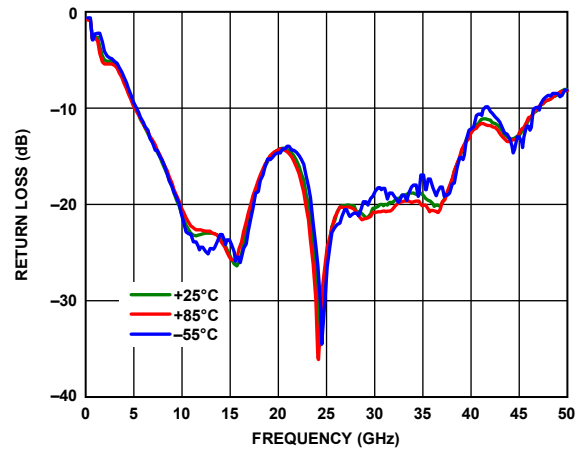

Figure 13. Output Return Loss vs. Frequency at Various Temperatures

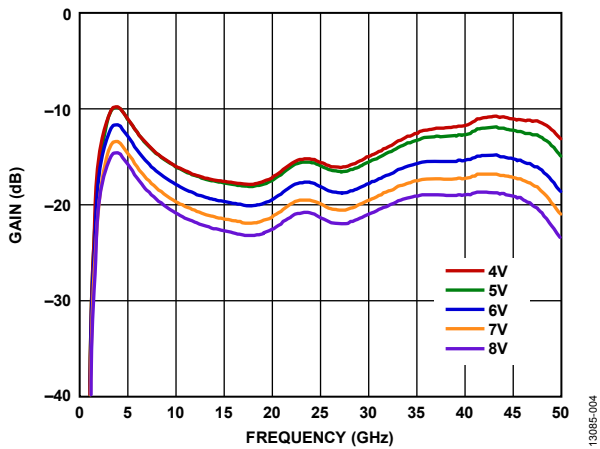

Figure 11. Gain vs. Frequency for Various Supply Voltages  
(For  $V_{DD} = 4\text{ V}$ ,  $V_{GG2} = 1.4\text{ V}$ ; for  $V_{DD} = 5\text{ V}$ ,  $V_{GG2} = 1.4\text{ V}$ ; for  $V_{DD} = 6\text{ V}$ ,  $V_{GG2} = 2\text{ V}$ ;  
for  $V_{DD} = 7\text{ V}$ ,  $V_{GG2} = 3\text{ V}$ ; for  $V_{DD} = 8\text{ V}$ ,  $V_{GG2} = 3.6\text{ V}$ )

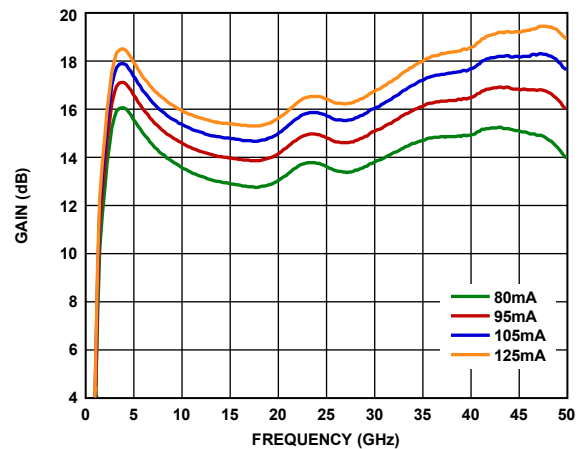

Figure 14. Gain vs. Frequency at Various  $I_{DD}$  ( $V_{DD} = 5\text{ V}$ ,  $V_{GG2} = 1.4\text{ V}$ )



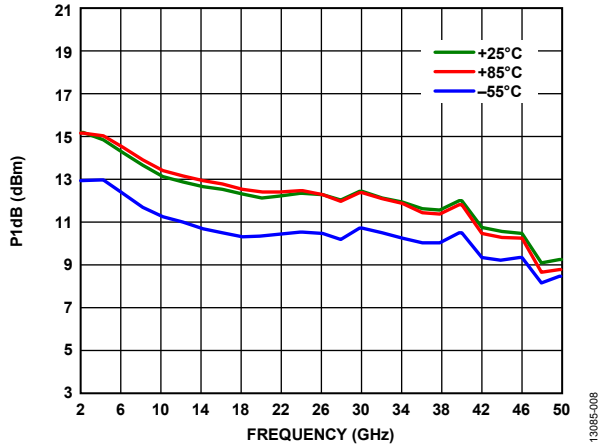

Figure 15. P1dB vs. Frequency at Various Temperatures

13085-008

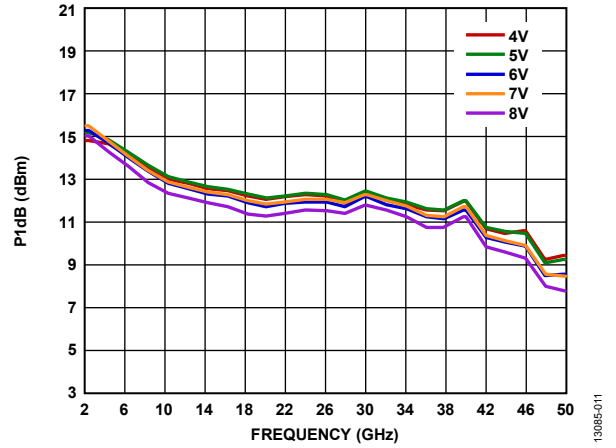

Figure 18. P1dB vs. Frequency for Various Supply Voltages  
(For  $V_{DD} = 4V, V_{GG2} = 1.4V$ ; for  $V_{DD} = 5V, V_{GG2} = 1.4V$ ; for  $V_{DD} = 6V, V_{GG2} = 2V$ ; for  $V_{DD} = 7V, V_{GG2} = 3V$ ; for  $V_{DD} = 8V, V_{GG2} = 3.6V$ )

13085-011

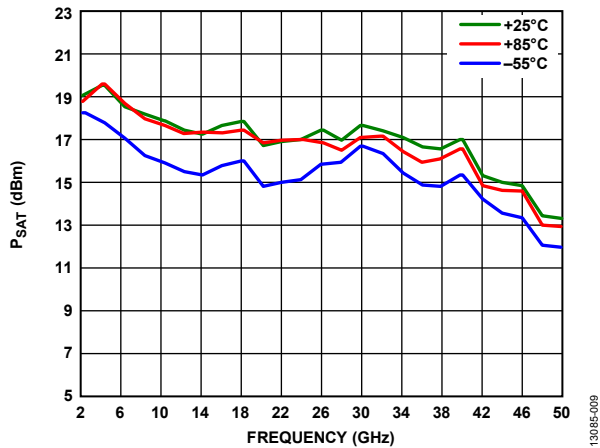

Figure 16.  $P_{SAT}$  vs. Frequency at Various Temperatures

13085-009

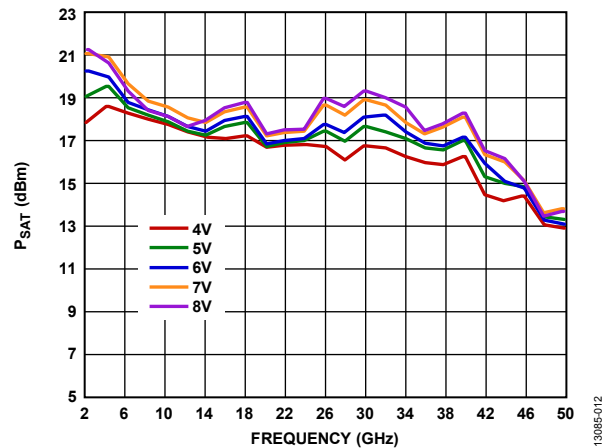

Figure 19.  $P_{SAT}$  vs. Frequency for Various Supply Voltages  
(For  $V_{DD} = 4V, V_{GG2} = 1.4V$ ; for  $V_{DD} = 5V, V_{GG2} = 1.4V$ ; for  $V_{DD} = 6V, V_{GG2} = 2V$ ; for  $V_{DD} = 7V, V_{GG2} = 3V$ ; for  $V_{DD} = 8V, V_{GG2} = 3.6V$ )

13085-012

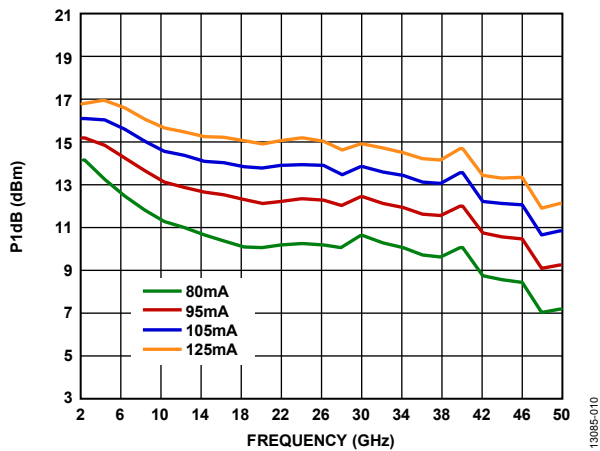

Figure 17. P1dB vs. Frequency for Various Supply Currents  
( $V_{DD} = 5V, V_{GG2} = 1.4V$ )

13085-010

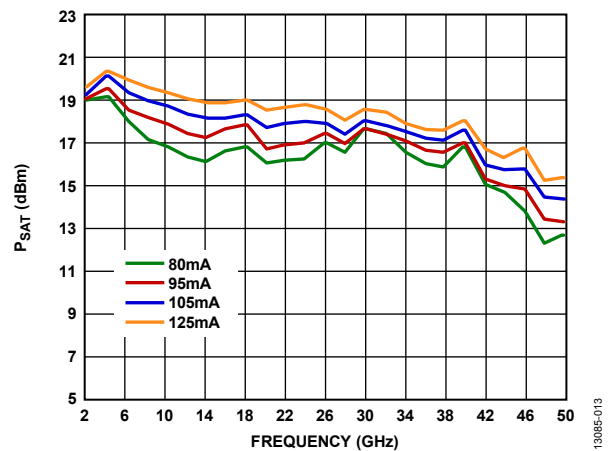

Figure 20.  $P_{SAT}$  vs. Frequency for Various Supply Currents  
( $V_{DD} = 5V, V_{GG2} = 1.4V$ )

13085-013

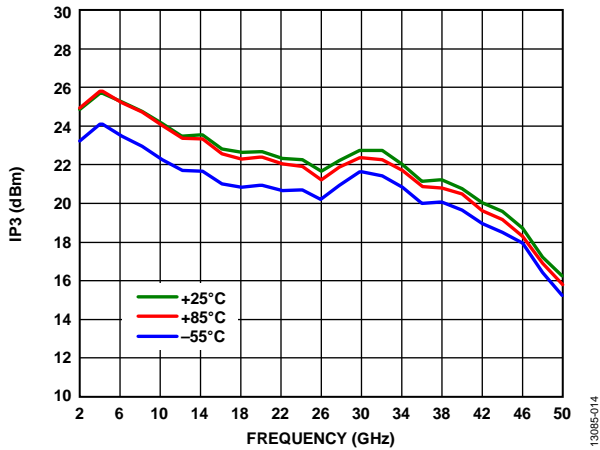

Figure 21. Output IP3 vs. Frequency at Various Temperatures,  $P_{OUT} = 0 \text{ dBm/Tone}$

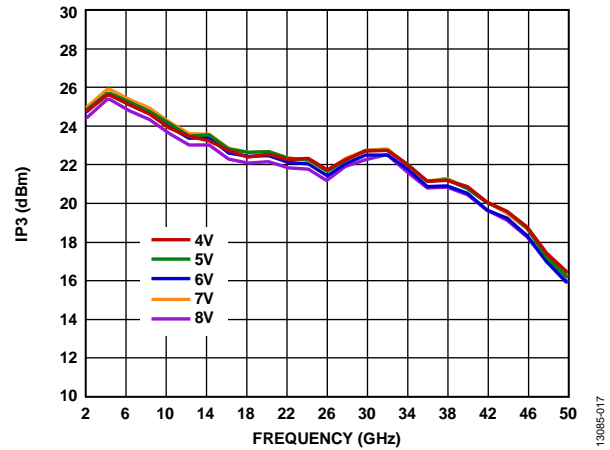

Figure 24. Output IP3 vs. Frequency for Various Supply Voltages,  $P_{OUT} = 0 \text{ dBm/Tone}$  (For  $V_{DD} = 4 \text{ V}$ ,  $V_{GG2} = 1.4 \text{ V}$ ; for  $V_{DD} = 5 \text{ V}$ ,  $V_{GG2} = 1.4 \text{ V}$ ; for  $V_{DD} = 6 \text{ V}$ ,  $V_{GG2} = 2 \text{ V}$ ; for  $V_{DD} = 7 \text{ V}$ ,  $V_{GG2} = 3 \text{ V}$ ; for  $V_{DD} = 8 \text{ V}$ ,  $V_{GG2} = 3.6 \text{ V}$ )

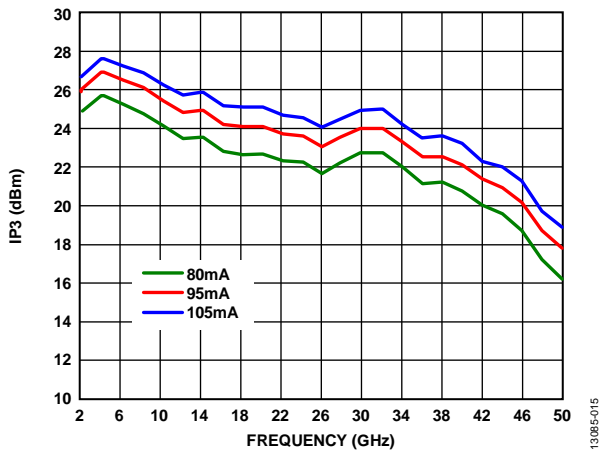

Figure 22. Output IP3 vs. Frequency for Various Supply Currents,  $P_{OUT} = 0 \text{ dBm/Tone}$  ( $V_{DD} = 5 \text{ V}$ ,  $V_{GG2} = 1.4 \text{ V}$ )

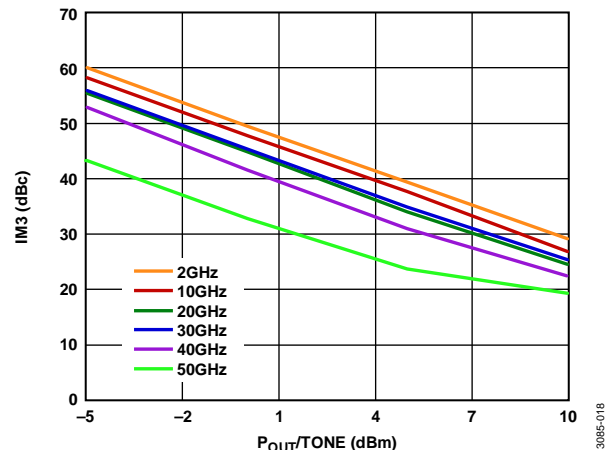

Figure 25. Output Third-Order Intermodulation (IM3) vs.  $P_{OUT}/\text{Tone}$  at  $V_{DD} = 4 \text{ V}$ ,  $V_{GG2} = 1.4 \text{ V}$

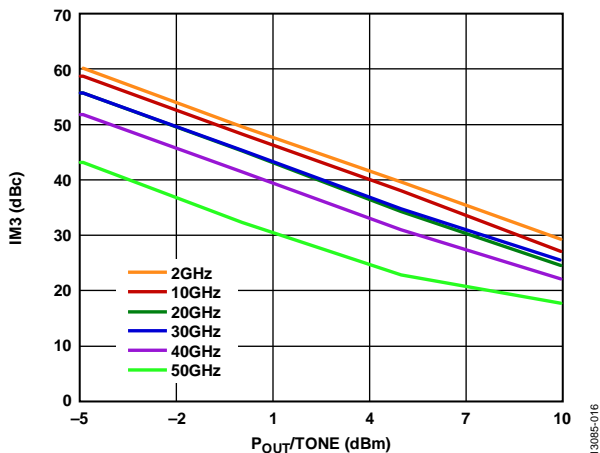

Figure 23. Output Third-Order Intermodulation (IM3) vs.  $P_{OUT}/\text{Tone}$  at  $V_{DD} = 5 \text{ V}$ ,  $V_{GG2} = 1.4 \text{ V}$

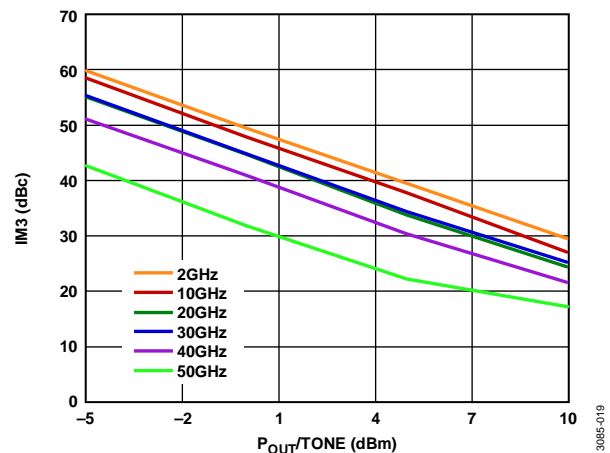

Figure 26. Output Third-Order Intermodulation (IM3) vs.  $P_{OUT}/\text{Tone}$  at  $V_{DD} = 6 \text{ V}$ ,  $V_{GG2} = 2 \text{ V}$

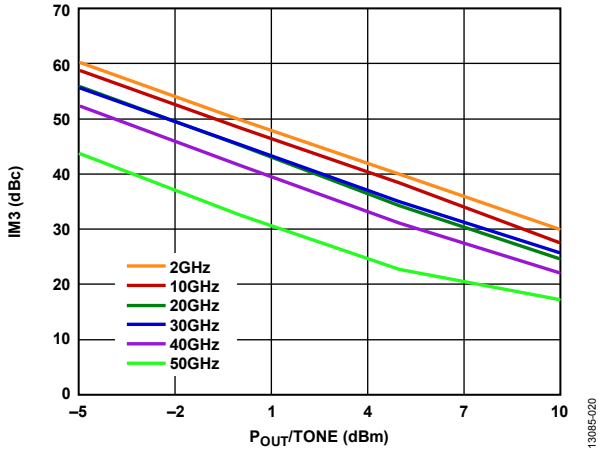

Figure 27. Output Third-Order Intermodulation (IM3) vs.  $P_{out}/Tone$  at  $V_{DD} = 7V, V_{GG2} = 3V$

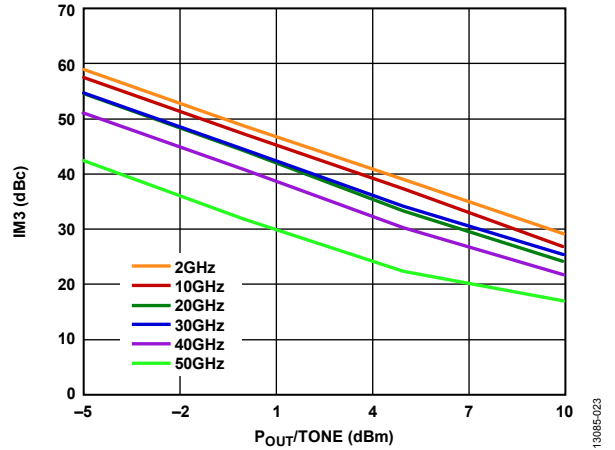

Figure 30. Output Third-Order Intermodulation (IM3) vs.  $P_{out}/Tone$  at  $V_{DD} = 8V, V_{GG2} = 3.6V$

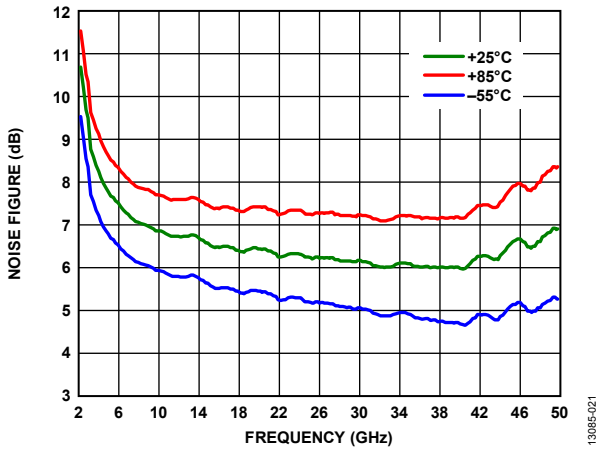

Figure 28. Noise Figure vs. Frequency at Various Temperatures

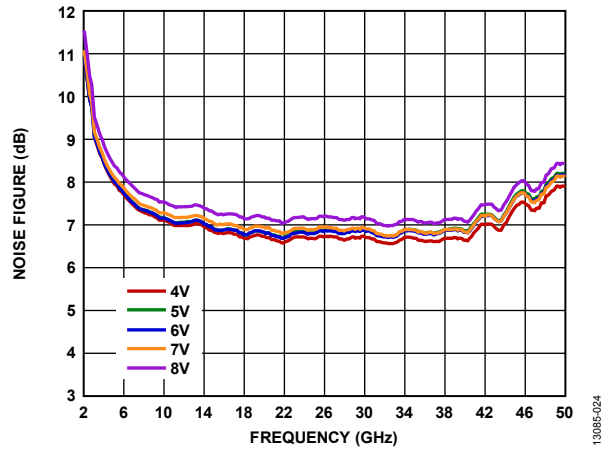

Figure 31. Noise Figure vs. Frequency at Various Supply Voltages (For  $V_{DD} = 4V, V_{GG2} = 1.4V$ ; for  $V_{DD} = 5V, V_{GG2} = 1.4V$ ; for  $V_{DD} = 6V, V_{GG2} = 2V$ ; for  $V_{DD} = 7V, V_{GG2} = 3V$ ; for  $V_{DD} = 8V, V_{GG2} = 3.6V$ )

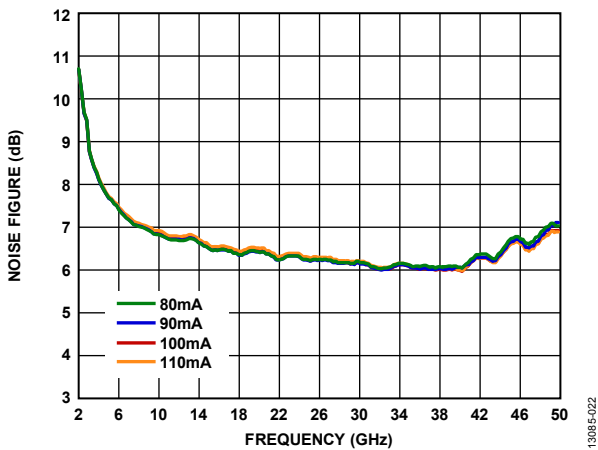

Figure 29. Noise Figure vs. Frequency at Various Supply Currents ( $V_{DD} = 5V, V_{GG2} = 1.4V$ )

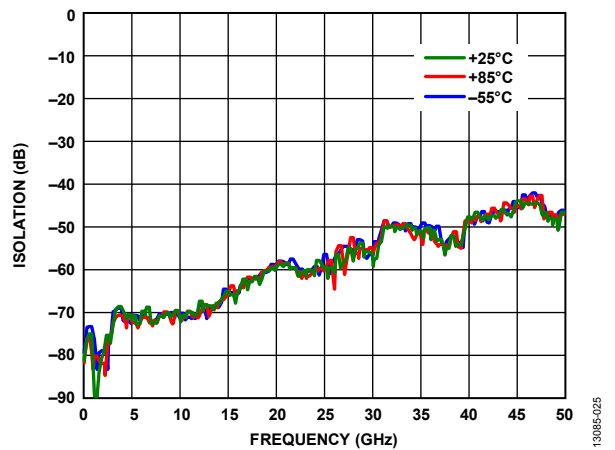

Figure 32. Reverse Isolation vs. Frequency at Various Temperatures

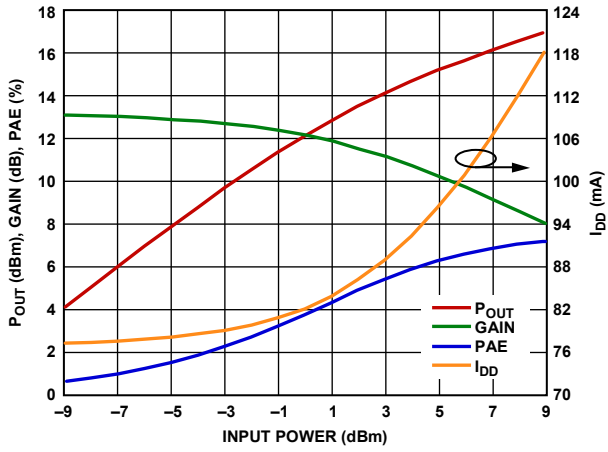

Figure 33. Power Compression at 24 GHz

130085-026

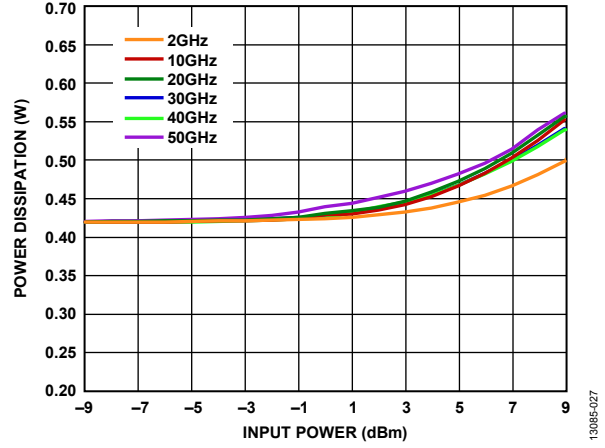

Figure 34. Power Dissipation vs. Input Power at 85°C for Various Frequencies

130085-027

## APPLICATIONS INFORMATION

The HMC1127 is a GaAs, pHEMT, MMIC, cascode distributed power amplifier.

The cascode distributed amplifier uses a fundamental cell of two field effect transistors (FETs) in series, source to drain. This fundamental cell then duplicates a number of times. The major benefit of this is an increase in the operation bandwidth. The basic schematic for a fundamental cell is given in Figure 35.

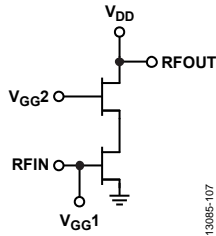

Figure 35. Fundamental Cell Schematic

The recommended bias sequence during power up is the following:

1. Connect GND.
2. Set  $V_{GG1}$  to  $-2$  V.
3. Set  $V_{DD}$  to 5 V.
4. Set  $V_{GG2}$  to 1.4 V.
5. Increase  $V_{GG1}$  to achieve a typical quiescent current ( $I_{DQ}$ ) = 80 mA.
6. Apply the RF signal.

The recommended bias sequence during power down is the following:

1. Turn off the RF signal.
2. Decrease  $V_{GG1}$  to  $-2$  V to achieve  $I_{DQ} = 0$  mA.
3. Decrease  $V_{GG2}$  to 0 V.
4. Decrease  $V_{DD}$  to 0 V.

Increase  $V_{GG1}$  to 0 V.

### MOUNTING AND BONDING TECHNIQUES FOR MILLIMETERWAVE GAAS MMICS

Attach the die directly to the ground plane eutectically or with conductive epoxy (see the Handling Precautions section, the Mounting section, and the Wire Bonding section).

Microstrip, 50  $\Omega$ , transmission lines on 0.127 mm (5 mil) thick alumina, thin film substrates are recommended for bringing the radio frequency to and from the chip (see Figure 36). When using 0.254 mm (10 mil) thick alumina, thin film substrates, raise the die 0.150 mm (6 mils) to ensure that the surface of the die is coplanar with the surface of the substrate. One way to accomplish this is to attach the 0.102 mm (4 mil) thick die to a 0.150 mm (6 mil) thick, molybdenum (Mo) heat spreader (moly tab) which can then be attached to the ground plane (see Figure 36 and Figure 37).

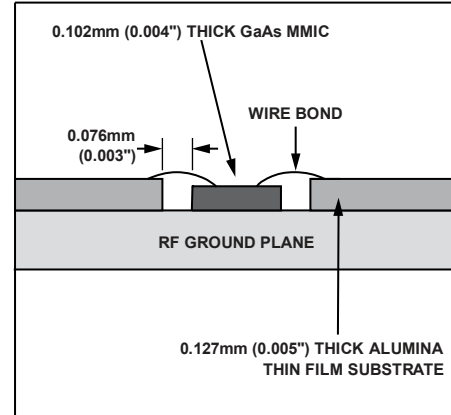

Figure 36. Die Without Moly Tab

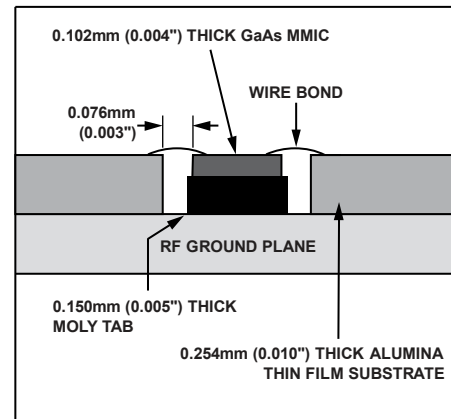

Figure 37. Die With Moly Tab

Place microstrip substrates as close to the die as possible to minimize bond wire length. Typical die to substrate spacing is 0.076 mm to 0.152 mm (3 mil to 6 mil).

### Handling Precautions

To avoid permanent damage, follow these storage, cleanliness, static sensitivity, transient, and general handling precautions:

- Place all bare die in either waffle or gel-based ESD protective containers and then seal the die in an ESD protective bag for shipment. Once the sealed ESD protective bag is opened, store all die in a dry nitrogen environment.
- Handle the chips in a clean environment. Do not attempt to clean the chip using liquid cleaning systems.
- Follow ESD precautions to protect against ESD strikes.
- While bias is applied, suppress instrument and bias supply transients. Use shielded signal and bias cables to minimize inductive pick up.
- Handle the chip along the edges with a vacuum collet or with a sharp pair of bent tweezers. The surface of the chip may have fragile air bridges and must not be touched with vacuum collet, tweezers, or fingers.

***Mounting***

The chip is back metallized and can be die mounted with AuSn eutectic preforms or with electrically conductive epoxy. Ensure that the mounting surface is clean and flat.

When eutectic die attached, a 80/20 gold tin preform is recommended with a work surface temperature of 255°C and a tool temperature of 265°C. When hot 90/10 nitrogen/hydrogen gas is applied, ensure that tool tip temperature is 290°C. Do not expose the chip to a temperature greater than 320°C for more than 20 seconds. For attachment, no more than 3 seconds of scrubbing is required.

When epoxy die attached, apply a minimum amount of epoxy to the mounting surface so that a thin epoxy fillet is observed around the perimeter of the chip once it is placed into position. Cure epoxy per the schedule of the manufacturer.

***Wire Bonding***

RF bonds made with two 1 mil wires are recommended. Ensure that these bonds are thermosonically bonded with a force of 40 grams to 60 grams. DC bonds of an 0.001 in. (0.025 mm) diameter, thermosonically bonded, are recommended. Make ball bonds with a force of 40 grams to 50 grams and wedge bonds with a force of 18 grams to 22 grams. Make all bonds with a nominal stage temperature of 150°C. Apply a minimum amount of ultrasonic energy to achieve reliable bonds. Make all bonds as short as possible, less than 12 mils (0.31 mm).

### APPLICATION CIRCUIT

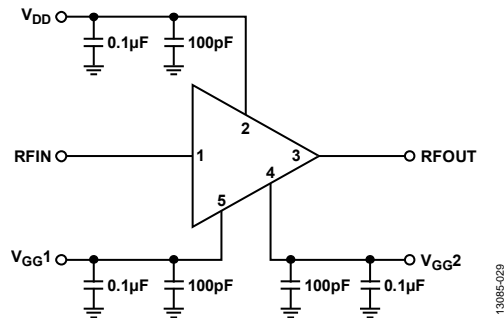

Figure 38. Typical Applications Circuit

13085-028

### ASSEMBLY DIAGRAM

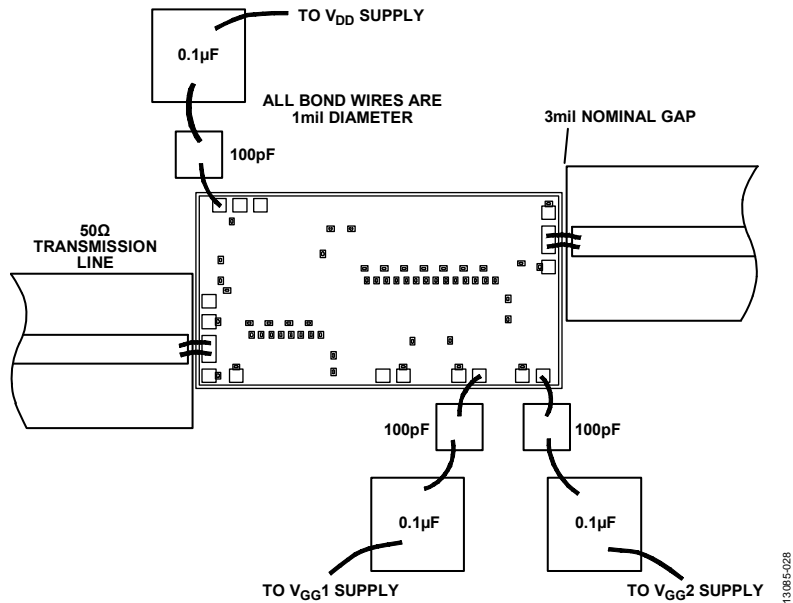

Figure 39. Assembly Diagram

13085-028

OUTLINE DIMENSIONS

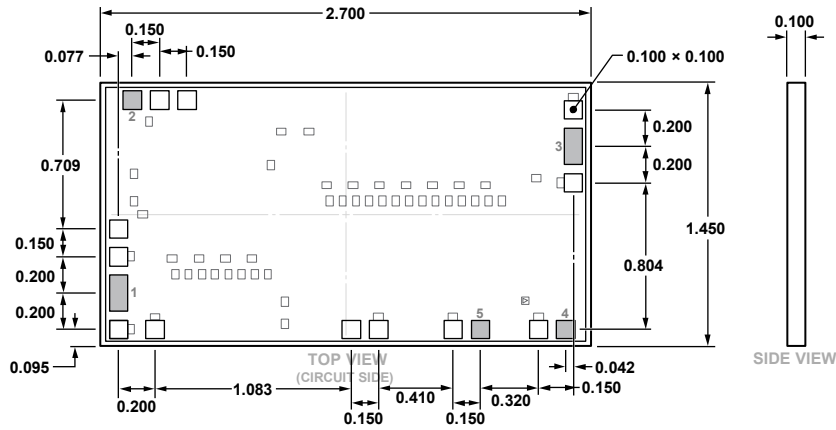

Figure 40. 5-Pad Bare Die [CHIP]  
(C-5-3)  
Dimensions shown in millimeters

ORDERING GUIDE

Model	Temperature Range	Package Description	Package Option
HMC1127	-55°C to +85°C	5-Pad Bare Die [CHIP]	C-5-3
HMC1127-SX	-55°C to +85°C	5-Pad Bare Die [CHIP]	C-5-3



## X-ON Electronics

Largest Supplier of Electrical and Electronic Components

*Click to view similar products for [RF Amplifier](#) category:*

*Click to view products by [Analog Devices](#) manufacturer:*

Other Similar products are found below :

[A82-1](#) [BGA622H6820XTSA1](#) [BGA 728L7 E6327](#) [BGB719N7ESDE6327XTMA1](#) [HMC397-SX](#) [HMC405](#) [HMC561-SX](#) [HMC8120-SX](#)  
[HMC8121-SX](#) [HMC-ALH382-SX](#) [HMC-ALH476-SX](#) [SE2433T-R](#) [SMA3101-TL-E](#) [SMA39](#) [A66-1](#) [A66-3](#) [A67-1](#) [A81-2](#) [LX5535LQ](#)  
[LX5540LL](#) [MAAM02350](#) [HMC3653LP3BETR](#) [HMC549MS8GETR](#) [HMC-ALH435-SX](#) [SMA101](#) [SMA32](#) [SMA411](#) [SMA531](#)  
[SST12LP19E-QX6E](#) [WPM0510A](#) [HMC5929LS6TR](#) [HMC5879LS7TR](#) [HMC1126](#) [HMC1087F10](#) [HMC1086](#) [HMC1016](#) [SMA1212](#)  
[MAX2689EWS+T](#) [MAAMSS0041TR](#) [MAAM37000-A1G](#) [LTC6430AIUF-15#PBF](#) [SMA70-2](#) [SMA4011](#) [A231](#) [HMC-AUH232](#) [LX5511LQ](#)  
[LX5511LQ-TR](#) [HMC7441-SX](#) [HMC-ALH310](#) [XD1001-BD-000V](#)