

FEATURES

- High saturated output power (P_{SAT}): 25 dBm
- High output third-order intercept (IP3): 35 dBm
- High gain: 22 dB (24 GHz to 27 GHz)
- High output power for 1 dB compression (P_{1dB}): 24 dBm
- DC supply: 5 V at 225 mA
- Compact 24-lead, 4 mm × 4 mm LCC package

APPLICATIONS

- Point-to-point radios
- Point-to-multipoint radios
- VSAT and SATCOM

GENERAL DESCRIPTION

The **HMC1131** is a gallium arsenide (GaAs), pseudomorphic high electron mobility transfer (pHEMT), monolithic microwave integrated circuit (MMIC), driver amplifier that operates from 24 GHz to 35 GHz. The **HMC1131** provides 22 dB of gain at the 24 GHz to 27 GHz range, 35 dBm output IP3, and 24 dBm of output power at 1 dB gain compression, while requiring 225 mA from a 5 V supply.

FUNCTIONAL BLOCK DIAGRAM

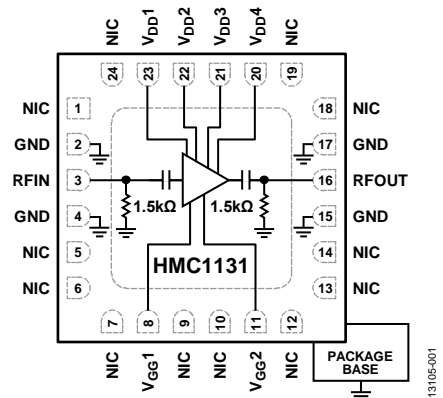

Figure 1.

The **HMC1131** is capable of supplying 25 dBm of saturated output power and is housed in a compact, 4 mm × 4 mm ceramic leadless chip carrier (24-lead LCC). The **HMC1131** is an ideal driver amplifier for a wide range of applications, including point-to-point radios, from 24 GHz to 35 GHz.

TABLE OF CONTENTS

| | | | |
|---------------------------------------|---|--|----|
| Features | 1 | ESD Caution..... | 4 |
| Applications..... | 1 | Pin Configuration and Function Descriptions..... | 5 |
| Functional Block Diagram | 1 | Interface Schematics | 6 |
| General Description | 1 | Typical Performance Characteristics | 7 |
| Revision History | 2 | Applications Information | 11 |
| Electrical Specifications | 3 | Evaluation PCB..... | 12 |
| 24 GHz to 27 GHz Frequency Range..... | 3 | Typical Application Circuit | 14 |
| 27 GHz to 35 GHz Frequency Range..... | 3 | Outline Dimensions | 15 |
| Absolute Maximum Ratings..... | 4 | Ordering Guide | 15 |

REVISION HISTORY

5/2019—Rev. B to Rev. C

| | |
|---------------------------------------|----|
| Changes to Figure 32 and Table 5..... | 13 |
| Changes to Ordering Guide | 15 |

6/2017—Rev. A to Rev. B

| | |
|----------------------------------|----|
| Changes to Table 5..... | 12 |
| Updated Outline Dimensions | 14 |
| Changes to Ordering Guide | 14 |

9/2015—Rev. 0 to Rev. A

| | |
|---|---|
| Changes to Features Section and General Description Section | 1 |
| Change to Gain Parameter, Table 1..... | 3 |

7/2015—Revision 0: Initial Version

ELECTRICAL SPECIFICATIONS

24 GHz TO 27 GHz FREQUENCY RANGE

$T_A = 25^\circ\text{C}$, $V_{DD1} = V_{DD2} = V_{DD3} = V_{DD4} = 5\text{ V}$, $I_{DD} = 225\text{ mA}$, unless otherwise stated. Adjust V_{GG1} and V_{GG2} between -2 V to 0 V to achieve $I_{DD} = 225\text{ mA}$ typical.

Table 1.

| Parameter | Symbol | Min | Typ | Max | Unit |
|---|-----------|-----|-------|-----|-------|
| FREQUENCY RANGE | | 24 | | 27 | GHz |
| GAIN | | 18 | 22 | | dB |
| Gain Variation Over Temperature | | | 0.031 | | dB/°C |
| RETURN LOSS | | | | | |
| Input | | | 8 | | dB |
| Output | | | 7 | | dB |
| OUTPUT | | | | | |
| Output Power for 1 dB Compression | P1dB | 20 | 23 | | dBm |
| Saturated Output Power | P_{SAT} | | 27 | | dBm |
| Output Third-Order Intercept ¹ | IP3 | | 34 | | dBm |
| SUPPLY CURRENT | | | | | |
| Total Supply Current | I_{DD} | | 225 | | mA |
| Total Supply Current vs. V_{DD}^2 | | | 4 | | V |
| | | | 5 | | V |

¹ Measurement taken at $P_{OUT}/\text{tone} = 10\text{ dBm}$.

² The amplifier operates over the full voltage ranges shown. V_{GG1} and V_{GG2} are adjusted to achieve $I_{DD} = 225\text{ mA}$ at 5 V .

27 GHz TO 35 GHz FREQUENCY RANGE

$T_A = 25^\circ\text{C}$, $V_{DD1} = V_{DD2} = V_{DD3} = V_{DD4} = 5\text{ V}$, $I_{DD} = 225\text{ mA}$, unless otherwise stated. Adjust V_{GG1} and V_{GG2} between -2 V to 0 V to achieve $I_{DD} = 225\text{ mA}$ typical.

Table 2.

| Parameter | Symbol | Min | Typ | Max | Unit |
|---|-----------|-----|-------|-----|-------|
| FREQUENCY RANGE | | 27 | | 35 | GHz |
| GAIN | | 18 | 20 | | dB |
| Gain Variation Over Temperature | | | 0.031 | | dB/°C |
| RETURN LOSS | | | | | |
| Input | | | 8 | | dB |
| Output | | | 7 | | dB |
| OUTPUT | | | | | |
| Output Power for 1 dB Compression | P1dB | 21 | 24 | | dBm |
| Saturated Output Power | P_{SAT} | | 25 | | dBm |
| Output Third-Order Intercept ¹ | IP3 | | 35 | | dBm |
| SUPPLY CURRENT | | | | | |
| Total Supply Current | I_{DD} | | 225 | | mA |
| Total Supply Current vs. V_{DD}^2 | | | 4 | | V |
| | | | 5 | | V |

¹ Measurement taken at $P_{OUT}/\text{tone} = 10\text{ dBm}$.

² The amplifier operates over the full voltage ranges shown. V_{GG1} and V_{GG2} are adjusted to achieve $I_{DD} = 225\text{ mA}$ at 5 V .

ABSOLUTE MAXIMUM RATINGS

Table 3.

| Parameter | Rating |
|--|--------------------------|
| Drain Bias Voltage (V_{DD}) | 5.5 V |
| RF Input Power (RFIN) | 12 dBm |
| Channel Temperature | 175°C |
| Continuous Power Dissipation (P_{DISS}), $T_A = 85^\circ\text{C}$ (Derate 22 mW/°C) | 1.97 W |
| Thermal Resistance, R_{TH} (Junction to Ground Paddle) | 45.5°C/W |
| Operating Temperature | -40°C to +85°C |
| Storage Temperature | -65°C to +150°C |
| ESD Sensitivity, Human Body Model (HBM) | Class 0, passed 150 V |
| Maximum Peak Reflow Temperature | 260°C |

Stresses at or above those listed under Absolute Maximum Ratings may cause permanent damage to the product. This is a stress rating only; functional operation of the product at these or any other conditions above those indicated in the operational section of this specification is not implied. Operation beyond the maximum operating conditions for extended periods may affect product reliability.

ESD CAUTION



ESD (electrostatic discharge) sensitive device. Charged devices and circuit boards can discharge without detection. Although this product features patented or proprietary protection circuitry, damage may occur on devices subjected to high energy ESD. Therefore, proper ESD precautions should be taken to avoid performance degradation or loss of functionality.

PIN CONFIGURATION AND FUNCTION DESCRIPTIONS

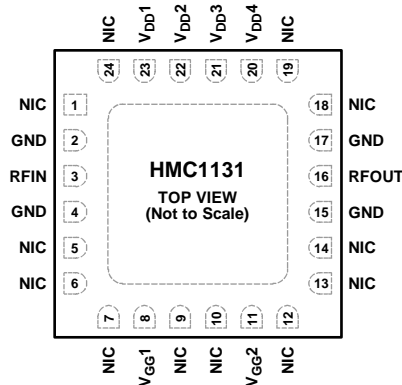

NOTES
 1. NIC = NOT INTERNALLY CONNECTED.
 2. THE EXPOSED PAD MUST BE CONNECTED TO RF/DC GROUND.

13105-100

Figure 2. Pin Configuration

Table 4. Pin Function Descriptions

| Pin No. | Mnemonic | Description |
|--|--------------------------------------|---|
| 1, 5 to 7, 9, 10, 12 to 14, 18, 19, 24 | NIC | Not Internally Connected. However, all data was measured with these pins connected to RF/dc ground externally. |
| 2, 4, 15, 17 | GND | Ground. These pins must be connected to RF/dc ground. |
| 3 | RFIN | RF Input. This pin is ac-coupled and matched to 50 Ω. |
| 8 | V _{GG1} | Gate Bias Pin for the First and Second Stages. External bypass capacitors of 100 pF, 10 nF, and 4.7 μF are required for this pin. |
| 11 | V _{GG2} | Gate Bias Pin for the Third and Fourth Stages. External bypass capacitors of 100 pF, 10 nF, and 4.7 μF are required for this pin. |
| 16 | RFOUT | RF Output. This pin is ac-coupled and matched to 50 Ω. |
| 20 to 23 | V _{DD4} to V _{DD1} | Drain Bias Voltage Pins. External bypass capacitors of 100 pF, 10 nF, and 4.7 μF are required for these pins. |
| | EPAD | Exposed Pad. The exposed pad must be connected to RF/dc ground. |

INTERFACE SCHEMATICS

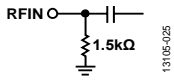

Figure 3. RFIN Interface Schematic

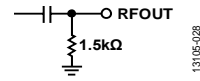

Figure 6. RFOUT Interface Schematic



Figure 4. GND Interface Schematic

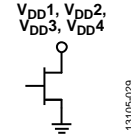

Figure 7. V_{DD1} to V_{DD4} Interface Schematic

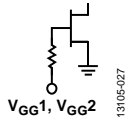

Figure 5. V_{GG1}/V_{GG2} Interface Schematic

TYPICAL PERFORMANCE CHARACTERISTICS

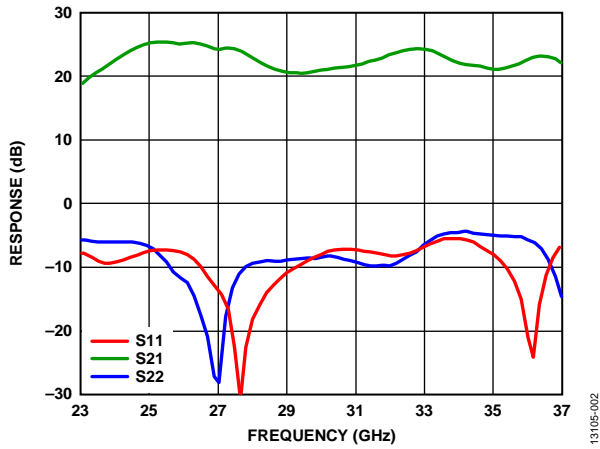

Figure 8. Response (Broadband Gain and Return Loss) vs. Frequency

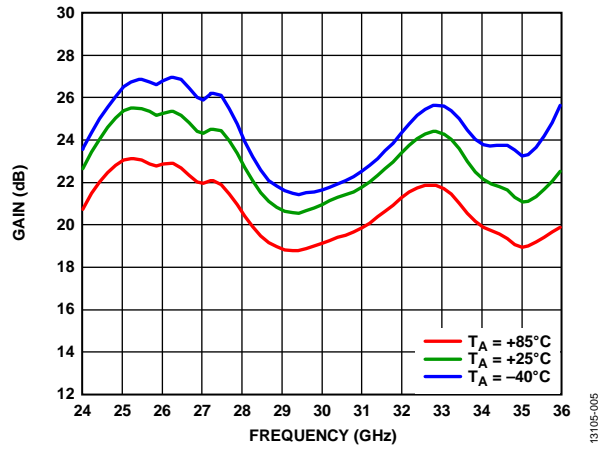

Figure 11. Gain vs. Frequency at Various Temperatures

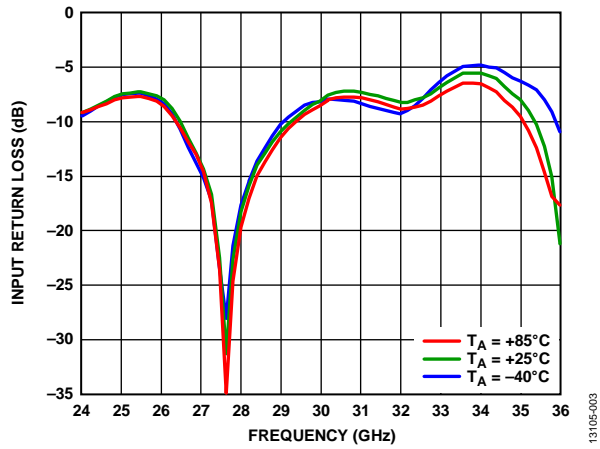

Figure 9. Input Return Loss vs. Frequency at Various Temperatures

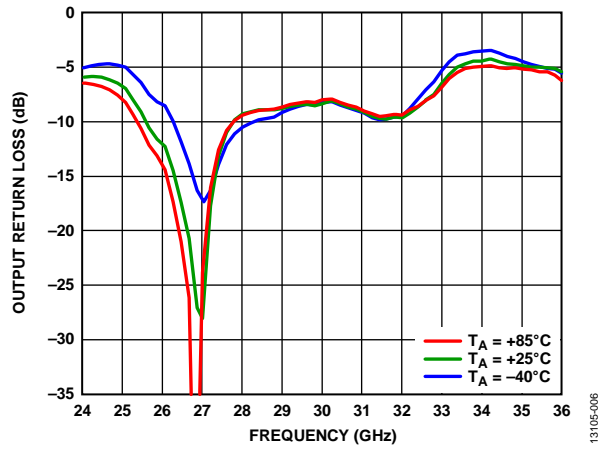

Figure 12. Output Return Loss vs. Frequency at Various Temperatures

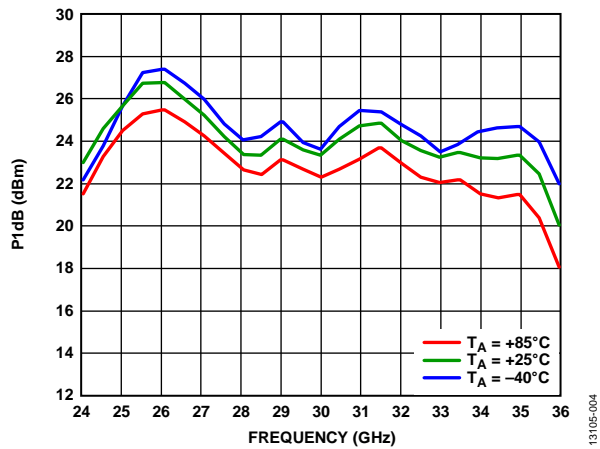

Figure 10. P1dB vs. Frequency at Various Temperatures

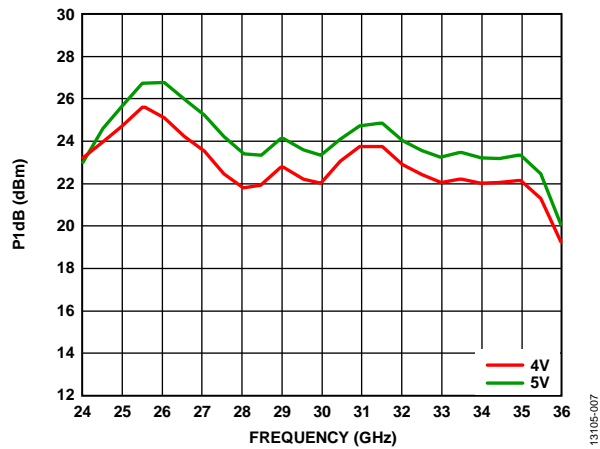

Figure 13. P1dB vs. Frequency at Various Supply Voltages

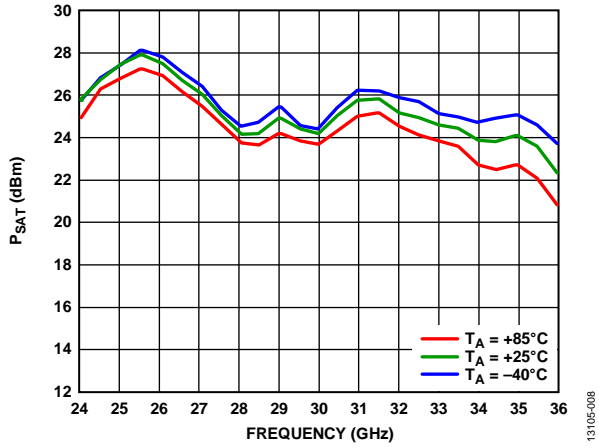

Figure 14. P_{SAT} vs. Frequency at Various Temperatures

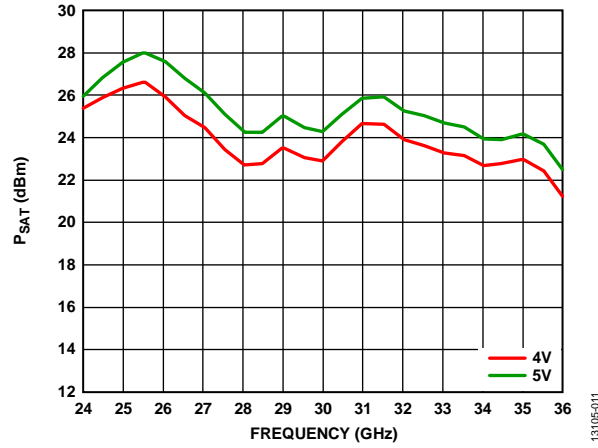

Figure 17. P_{SAT} vs. Frequency at Various Supply Voltages

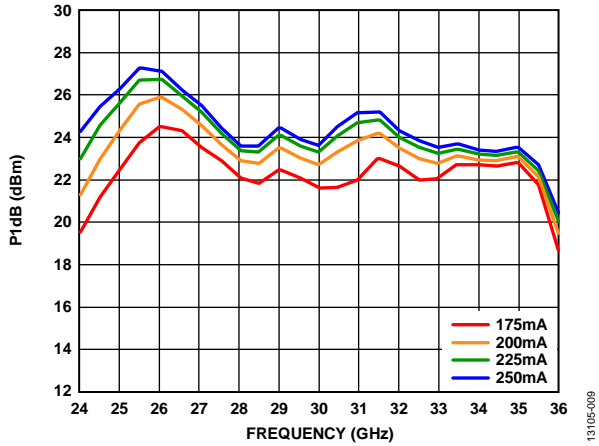

Figure 15. P_{1dB} vs. Frequency at Various Supply Currents

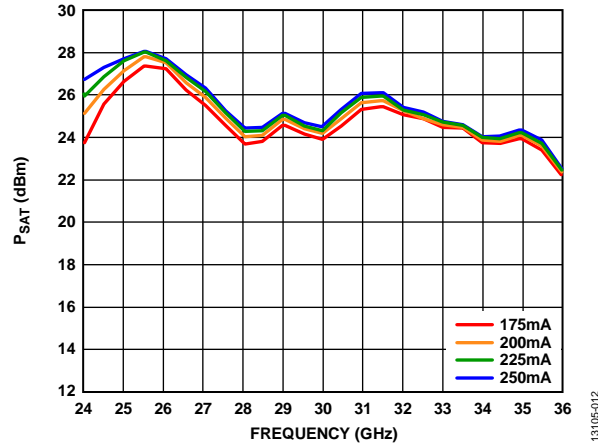

Figure 18. P_{SAT} vs. Frequency at Various Supply Currents

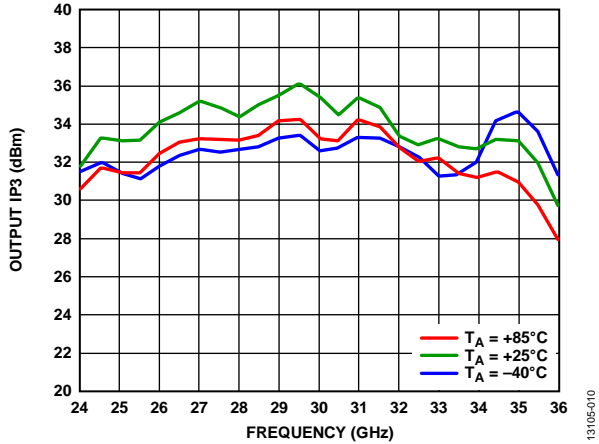

Figure 16. Output IP_3 vs. Frequency at Various Temperatures, $P_{out}/Tone = 10\text{ dBm}$

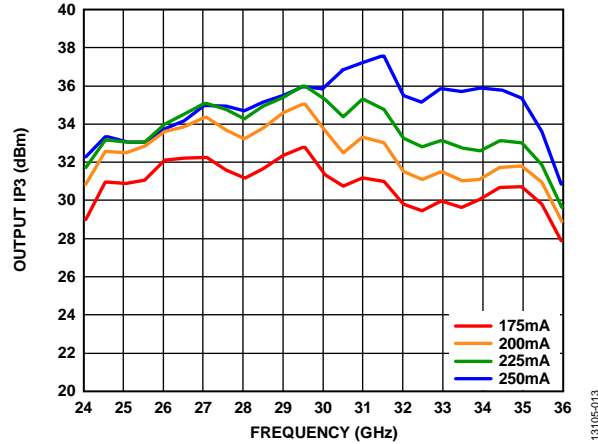

Figure 19. Output IP_3 vs. Frequency at Various Supply Currents, $P_{out}/Tone = 10\text{ dBm}$

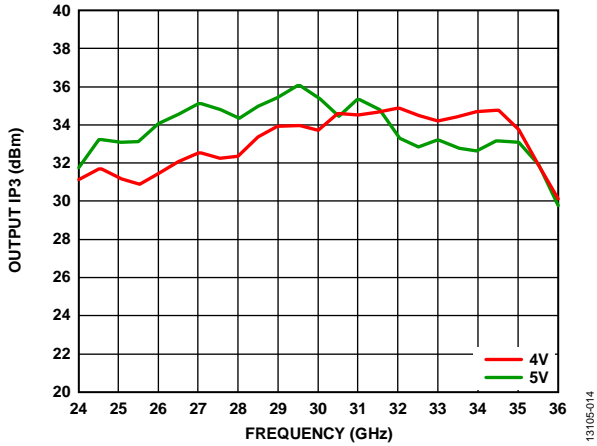

Figure 20. Output IP3 vs. Frequency for Various Supply Voltages, $P_{OUT}/Tone = 10\text{ dBm}$

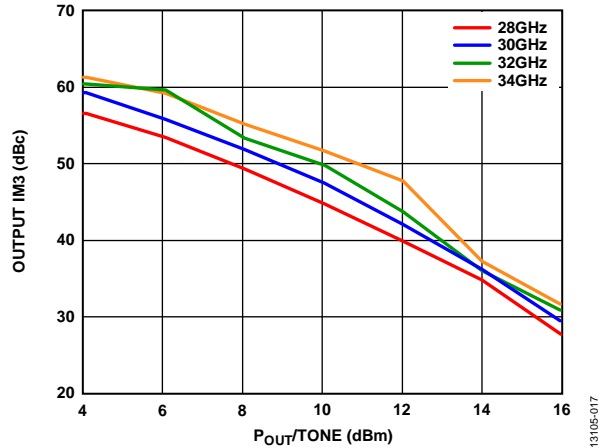

Figure 23. Output Third-Order Intermodulation (IM3) vs. $P_{OUT}/Tone$ at $V_{DD} = 4\text{ V}$

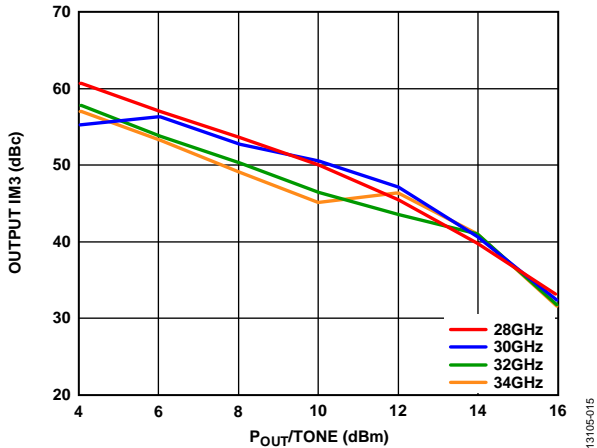

Figure 21. Output Third-Order Intermodulation (IM3) vs. $P_{OUT}/Tone$ at $V_{DD} = 5\text{ V}$

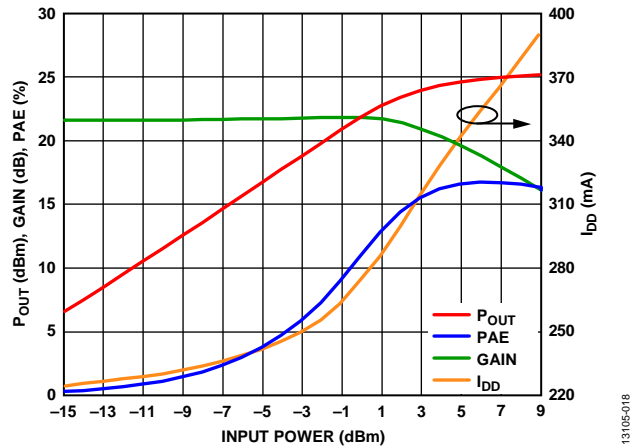

Figure 24. Power Compression at 30.5 GHz (PAE Is Power Added Efficiency)

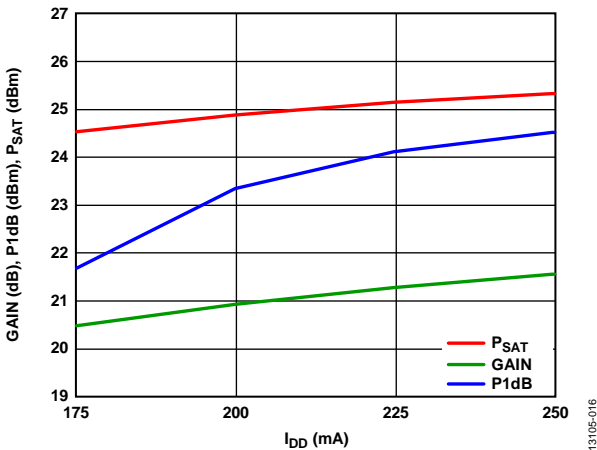

Figure 22. Gain, P1dB, and P_{SAT} vs. Supply Current (I_{DD}) at 30.5 GHz

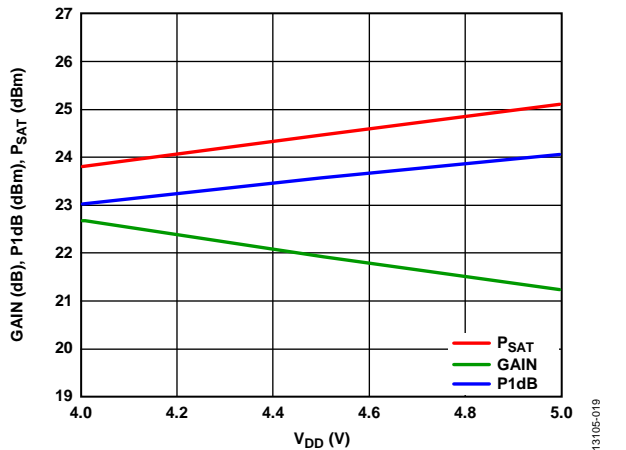

Figure 25. Gain, P1dB, and P_{SAT} vs. Supply Voltage (V_{DD}) at 30.5 GHz

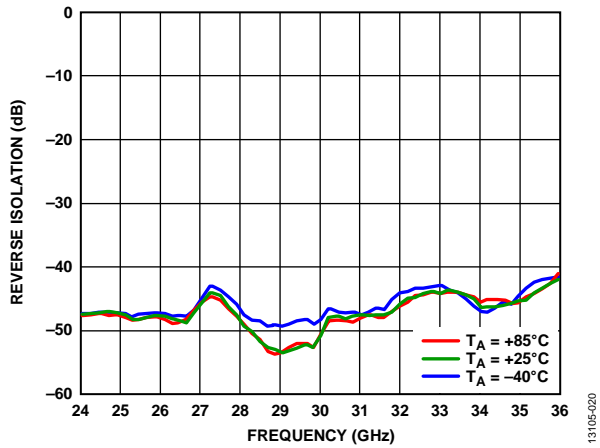

Figure 26. Reverse Isolation vs. Frequency at Various Temperatures

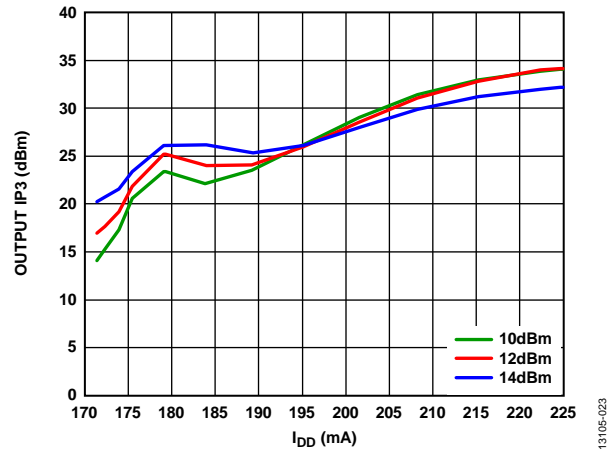

Figure 29. Output IP3 vs. I_{DD} over $P_{OUT}/Tone$ at 30 GHz, $V_{DD} = 5 V$, $I_{DD} = 225 mA$, $I_{DD2} = Fixed$, and I_{DD1} Varied from 0 mA to 50 mA

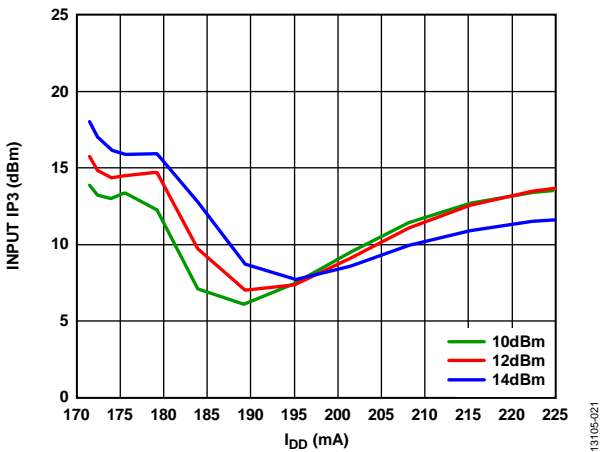

Figure 27. Input IP3 vs. I_{DD} over $P_{OUT}/Tone$ at 30 GHz, $V_{DD} = 5 V$, $I_{DD} = 225 mA$, $I_{DD2} = Fixed$, and I_{DD1} Varied from 0 mA to 50 mA

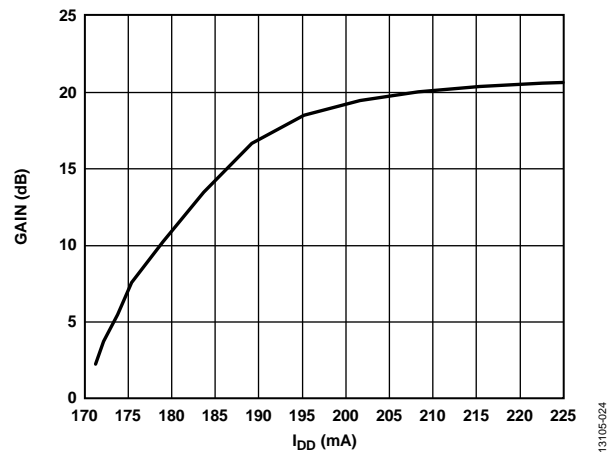

Figure 30. Gain vs. I_{DD} over $P_{OUT}/Tone = 14 dBm$ at 30 GHz, $V_{DD} = 5 V$, $I_{DD} = 225 mA$, $I_{DD2} = Fixed$, and I_{DD1} Varied from 0 mA to 50 mA

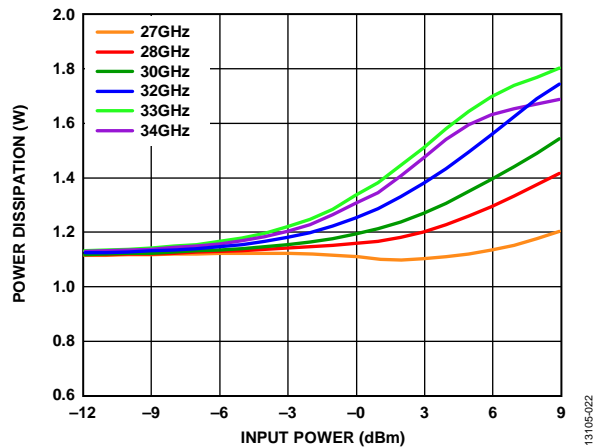

Figure 28. Power Dissipation (P_{DISS}) at 85°C vs. Input Power for Various Frequencies

13105-020

13105-023

13105-021

13105-024

13105-022

APPLICATIONS INFORMATION

The HMC1131 is a GaAs, pHEMT, MMIC, medium power amplifier consisting of four gain stages in series. V_{GG1} is the gate bias pin for the first and second stages, while V_{GG2} is the gate bias pin for the third and fourth stages. A simplified block diagram is shown in Figure 31.

All measurements for this device were taken using the evaluation printed circuit board (PCB) in its default configuration. Unless otherwise noted, the V_{GG1} , V_{GG2} , and V_{DD1} to V_{DD4} pins were tied together during measurement, respectively.

The following is the recommended bias sequence during power-up:

1. Connect to ground.
2. Set V_{GG1} and V_{GG2} to -2 V.
3. Set V_{DD1} through V_{DD4} to 5 V.
4. Increase V_{GG1} and V_{GG2} to achieve a quiescent $I_{DD} = 225$ mA.
5. Apply the RF signal.

The following is the recommended bias sequence during power-down:

1. Turn the RF signal off.
2. Decrease V_{GG1} and V_{GG2} to -2 V to achieve a quiescent $I_{DD} = 0$ mA (approximately).
3. Decrease V_{DD1} through V_{DD4} to 0 V.
4. Increase V_{GG1} and V_{GG2} to 0 V.

The $V_{DDX} = 5$ V and $I_{DD} = 225$ mA bias conditions are the operating points recommended to optimize the overall performance. Unless otherwise noted, the data shown was taken using the recommended bias conditions. Operation of the HMC1131 at different bias conditions may result in performance that differs from that shown in Figure 27 and Figure 30. Biasing the HMC1131 for higher drain current typically results in higher P1dB, OIP3, and gain but at the expense of increased power consumption.

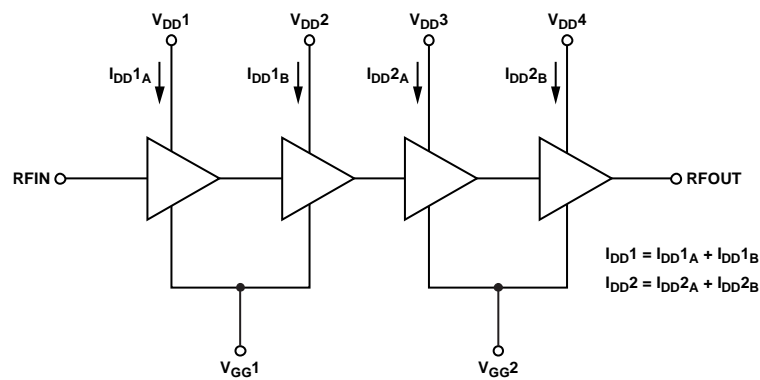

Figure 31. Simplified Block Diagram

13105-032

EVALUATION PCB

Generate the evaluation PCB used in this application with proper RF circuit design techniques. Signal lines at the RF port must have 50 Ω impedance, and the package ground leads and

exposed paddle must be connected directly to the ground plane similar to what is shown in Figure 32. Use a sufficient number of via holes to connect the top and bottom ground planes.

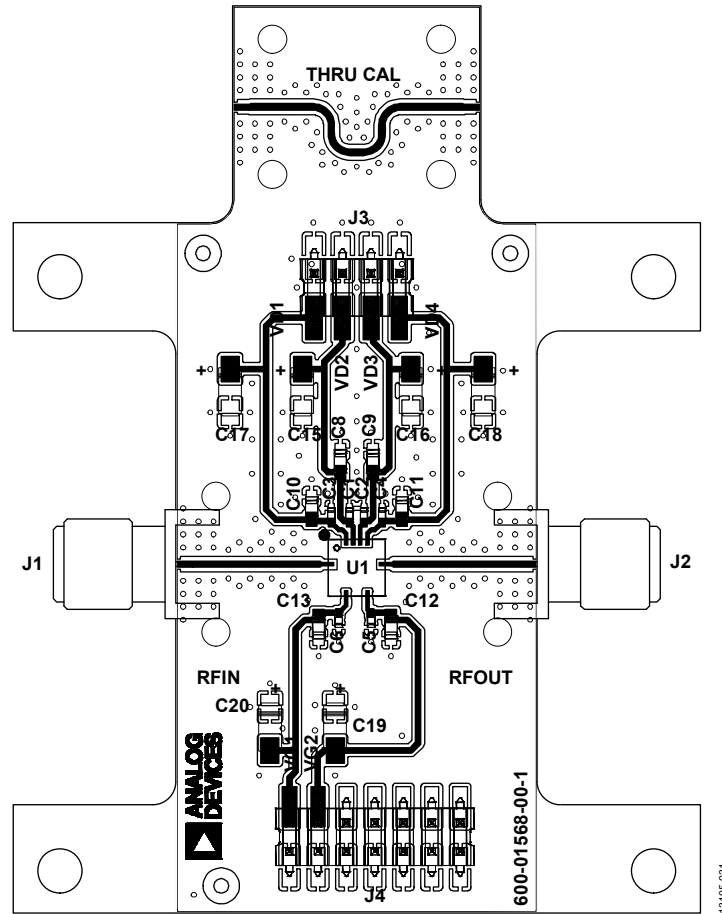

Figure 32. 600-01568-00-1 Evaluation PCB

Bill of Materials

Table 5. Evaluation Board (EV1HMC1131LC4) Bill of Materials

| Item | Description | Manufacturer ¹ |
|------------|--|--|
| J1, J2 | PCB mount, K connector | Analog Devices, Inc. 600-01568-00-1, Analog Devices, Inc. |
| J3, J4 | DC pins | |
| C1 to C6 | 100 pF capacitors, 0402 package | |
| C8 to C13 | 0.01 μF capacitors, 0603 package | |
| C15 to C20 | 4.7 μF capacitors, Case A tantalum | |
| U1 | HMC1131LC4 | |
| PCB | 600-01568-00-1 evaluation board, Rogers 4350, or Arlon 25FR circuit board material | |

¹ Blank cells in the manufacturer column left blank intentionally for they are user selectable.

TYPICAL APPLICATION CIRCUIT

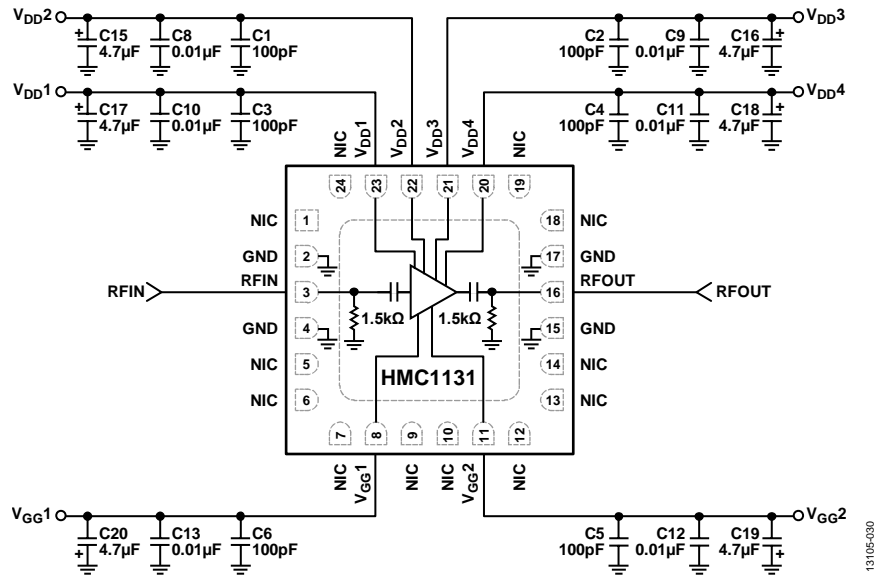

Figure 33. Typical Application Circuit

13106-030

OUTLINE DIMENSIONS

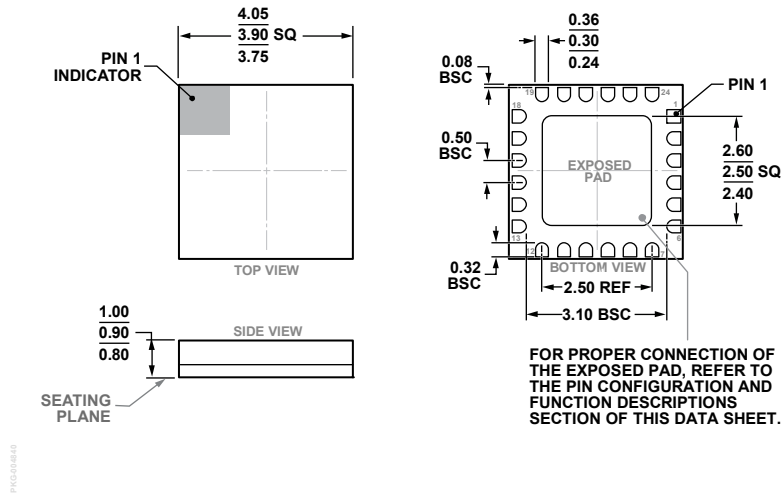

Figure 34. 24-Terminal Ceramic Leadless Chip Carrier [LCC] (E-24-1)
Dimensions shown in millimeters

ORDERING GUIDE

| Model ¹ | Temperature Range | Moisture Sensitivity Level (MSL) Rating ² | Lead Finish | Package Description | Package Option |
|--------------------|-------------------|--|------------------|---------------------|----------------|
| HMC1131LC4 | -40°C to +85°C | MSL3 | Gold over Nickel | 24-Terminal LCC | E-24-1 |
| HMC1131LC4TR | -40°C to +85°C | MSL3 | Gold over Nickel | 24-Terminal LCC | E-24-1 |
| EV1HMC1131LC4 | | | | Evaluation Board | |

¹ All models are RoHS Compliant.

² See the Absolute Maximum Ratings section.

X-ON Electronics

Largest Supplier of Electrical and Electronic Components

Click to view similar products for [RF Amplifier](#) category:

Click to view products by [Analog Devices](#) manufacturer:

Other Similar products are found below :

[A82-1](#) [BGA622H6820XTSA1](#) [BGA 728L7 E6327](#) [BGB719N7ESDE6327XTMA1](#) [HMC397-SX](#) [HMC405](#) [HMC561-SX](#) [HMC8120-SX](#)
[HMC8121-SX](#) [HMC-ALH382-SX](#) [HMC-ALH476-SX](#) [SE2433T-R](#) [SMA3101-TL-E](#) [SMA39](#) [A66-1](#) [A66-3](#) [A67-1](#) [A81-2](#) [LX5535LQ](#)
[LX5540LL](#) [MAAM02350](#) [HMC3653LP3BETR](#) [HMC549MS8GETR](#) [HMC-ALH435-SX](#) [SMA101](#) [SMA32](#) [SMA411](#) [SMA531](#)
[SST12LP19E-QX6E](#) [WPM0510A](#) [HMC5929LS6TR](#) [HMC5879LS7TR](#) [HMC1087F10](#) [HMC1086](#) [HMC1016](#) [SMA1212](#) [MAX2689EWS+T](#)
[MAAMSS0041TR](#) [MAAM37000-A1G](#) [LTC6430AIUF-15#PBF](#) [SMA70-2](#) [SMA4011](#) [A231](#) [HMC-AUH232](#) [LX5511LQ](#) [LX5511LQ-TR](#)
[HMC7441-SX](#) [HMC-ALH310](#) [XD1001-BD-000V](#) [A4011](#)