

FEATURES

Saturated output power (P_{SAT}): 30.5 dBm at 22% power added efficiency (PAE)

High output IP3: 35 dBm

High gain: 22 dB

DC supply: 6 V at 600 mA

No external matching required

32-lead, 5 mm × 5 mm LFCSP package

APPLICATIONS

Point-to-point radios

Point-to-multipoint radios

VSAT and SATCOM

Military and space

GENERAL DESCRIPTION

The **HMC1132** is a four-stage, GaAs pHEMT MMIC, 1 watt power amplifier that operates between 27 GHz and 32 GHz. The **HMC1132** provides 22 dB of gain and 30.5 dBm of saturated output power at 22% PAE from a 6 V power supply.

The **HMC1132** exhibits excellent linearity and it is optimized for high capacity, point-to-point and point-to-multipoint radio

FUNCTIONAL BLOCK DIAGRAM

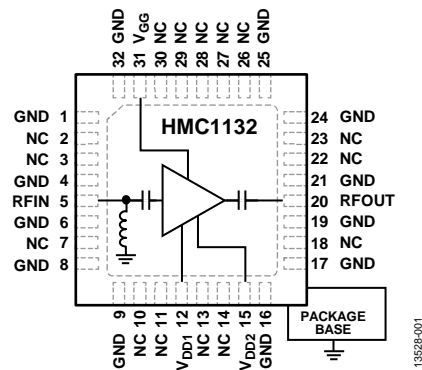

Figure 1.

systems. The amplifier configuration and high gain make it an excellent candidate for last stage signal amplification before the antenna.

The **HMC1132** amplifier input/outputs (I/Os) are internally matched to 50 Ω. The device is supplied in a compact, leadless QFN, 5 mm × 5 mm surface-mount package.

TABLE OF CONTENTS

Features	1	Interface Schematics	5
Applications.....	1	Typical Performance Characteristics	6
Functional Block Diagram	1	Theory of Operation	10
General Description	1	Applications Information	11
Revision History	2	Application Circuit.....	11
Specifications.....	3	Evaluation Board	12
Electrical Specifications.....	3	Bill of Materials.....	12
Absolute Maximum Ratings.....	4	Evaluation Board Schematic	13
ESD Caution.....	4	Outline Dimensions	14
Pin Configuration and Function Descriptions.....	5	Ordering Guide.....	14

REVISION HISTORY

7/2016—Revision 0: Initial Version

SPECIFICATIONS

ELECTRICAL SPECIFICATIONS

$T_A = 25^\circ\text{C}$, $V_{DD} = V_{DD1} = V_{DD2} = 6\text{ V}$, $I_{DD} = 600\text{ mA}$.

Table 1.

Parameter	Symbol	Min	Typ	Max	Unit	Test Conditions/Comments
FREQUENCY RANGE		27		32	GHz	
GAIN		20	22		dB	
Gain Variation over Temperature			0.036		dB/°C	
RETURN LOSS						
Input			6		dB	
Output			14		dB	
POWER						
Output Power for 1 dB Compression	P1dB	28	30		dBm	
Saturated Output Power	P _{SAT}		30.5		dBm	
OUTPUT THIRD-ORDER INTERCEPT	IP3		35		dBm	Measurement taken at 6 V at 600 mA, P _{OUT} ÷ tone = 20 dBm
SUPPLY VOLTAGE	V _{DD}	4		6	V	
QUIESCENT SUPPLY CURRENT	I _{DD}	400		700	mA	

ABSOLUTE MAXIMUM RATINGS

Table 2.

Parameter	Rating
Drain Voltage Bias	6.5 V
RF Input Power (RFIN) ¹	18 dBm
Channel Temperature	175°C
Continuous P _{DISS} (T = 85°C) (Derate 61 mw/°C Above 85°C)	5.49 W
Thermal Resistance (R _{TH}) Junction to Ground Paddle	16.4°C/W
Maximum Peak Reflow Temperature	260°C
Storage Temperature Range	-40°C to +150°C
Operating Temperature Range	-40°C to +85°C
ESD Sensitivity (Human Body Model)	Class 0, passed 150 V

¹ Maximum P_{IN} is limited to 18 dBm or thermal limits constrained by maximum power dissipation (see Figure 31), whichever is lower.

Stresses at or above those listed under Absolute Maximum Ratings may cause permanent damage to the product. This is a stress rating only; functional operation of the product at these or any other conditions above those indicated in the operational section of this specification is not implied. Operation beyond the maximum operating conditions for extended periods may affect product reliability.

ESD CAUTION



ESD (electrostatic discharge) sensitive device. Charged devices and circuit boards can discharge without detection. Although this product features patented or proprietary protection circuitry, damage may occur on devices subjected to high energy ESD. Therefore, proper ESD precautions should be taken to avoid performance degradation or loss of functionality.

PIN CONFIGURATION AND FUNCTION DESCRIPTIONS

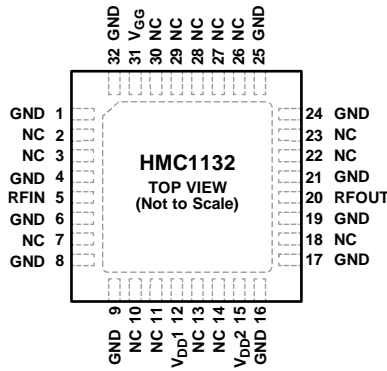

- NOTES**
 1. NC = NO CONNECT.
 2. EXPOSED PAD. EXPOSED PAD MUST BE CONNECTED TO RF/DC GROUND.

13528-002

Figure 2. Pin Configuration

Table 3. Pad Function Descriptions

Pin No.	Mnemonic	Description
1, 4, 6, 8, 9, 16, 17, 19, 21, 24, 25, 32	GND	Ground. These pins are exposed ground paddles that must be connected to RF/dc ground.
2, 3, 7, 10, 11, 13, 14, 18, 22, 23, 26 to 30	NC	No Connect. These pins are not connected internally. However, all data was measured with these pins connected to RF/dc ground externally.
5	RFIN	RF Input. This pin is dc-coupled and matched to 50 Ω. See Figure 4 for the RFIN interface schematic.
12, 15	V _{DD1} , V _{DD2}	Drain Bias Voltage. External by pass capacitors of 100 pF, 10 nF, and 4.7 μF are required. See Figure 5 for the V _{DD1} and V _{DD2} interface schematic.
20	RFOUT	RF Output. This pin is ac-coupled and matched to 50 Ω. See Figure 6 for the RFOUT interface schematic.
31	V _{GG}	Gate Control for Amplifier. Adjust V _{GG} to achieve the recommended bias current. External bypass capacitors of 100 pF, 10 nF, and 4.7 μF are required. See Figure 7 for the V _{GG} interface schematic.
	EPAD	Exposed Paddle. The exposed pad must be connected to RF/dc ground.

INTERFACE SCHEMATICS

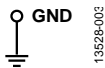

13528-003

Figure 3. GND Interface

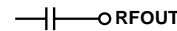

13528-006

Figure 6. RFOUT Interface

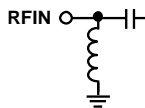

13528-004

Figure 4. RFIN Interface

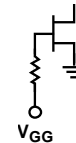

13528-007

Figure 7. V_{GG} Interface

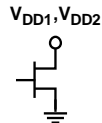

13528-005

Figure 5. V_{DD1} and V_{DD2} Interface

TYPICAL PERFORMANCE CHARACTERISTICS

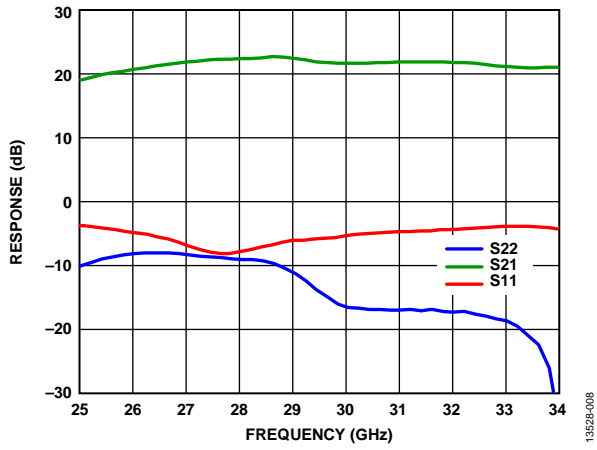

Figure 8. Broadband Gain and Return Loss vs. Frequency

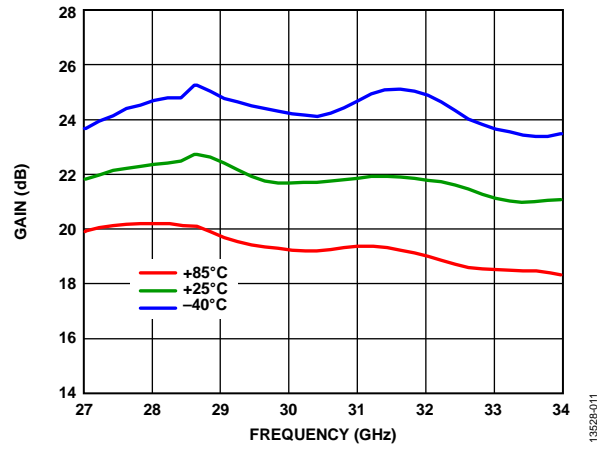

Figure 11. Gain vs. Frequency at Various Temperatures

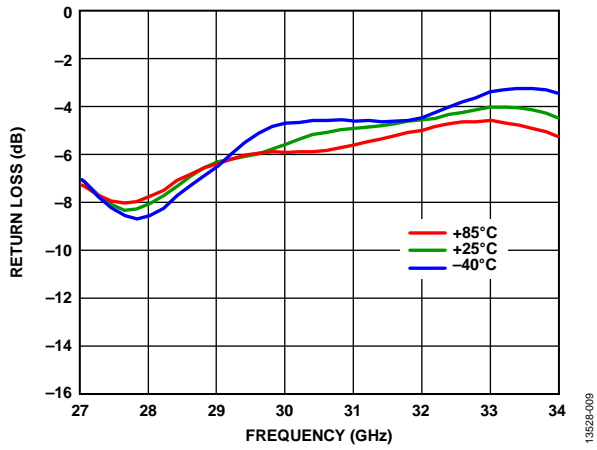

Figure 9. Input Return Loss vs. Frequency at Various Temperatures

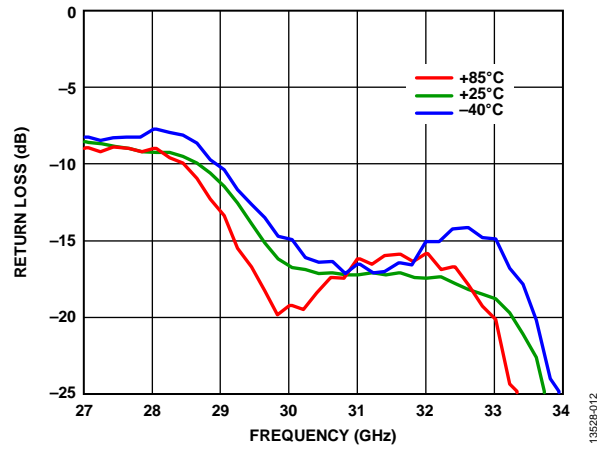

Figure 12. Output Return Loss vs. Frequency at Various Temperatures

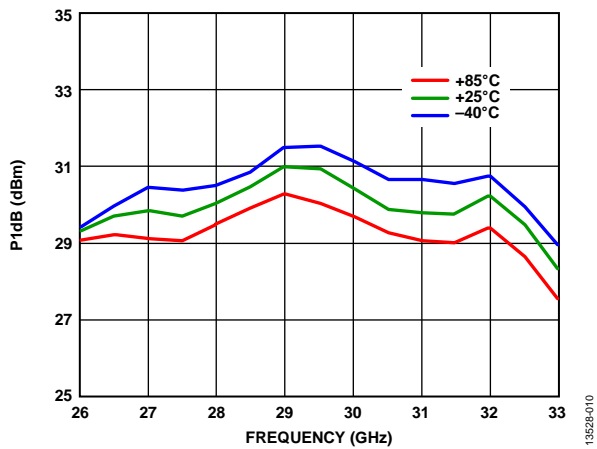

Figure 10. P1dB vs. Frequency at Various Temperatures

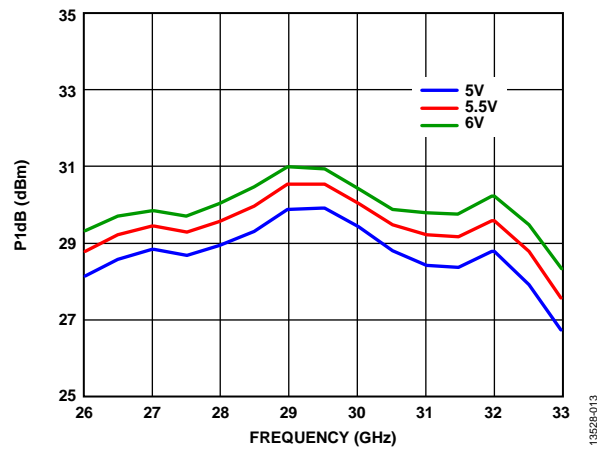

Figure 13. P1dB vs. Frequency at Various Supply Voltages

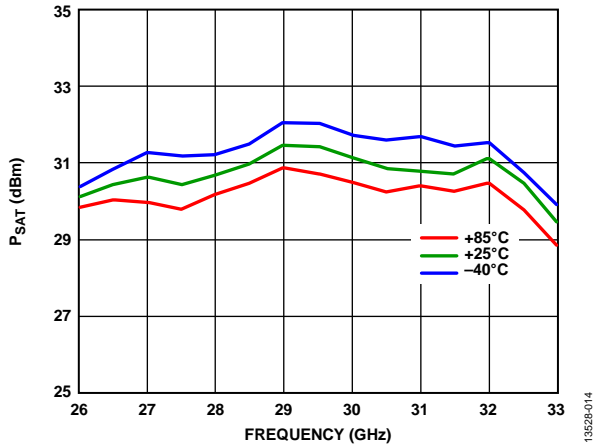

Figure 14. P_{SAT} vs. Frequency at Various Temperatures

13528-014

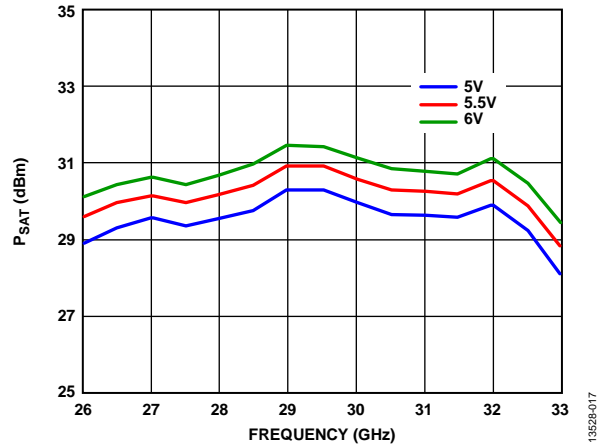

Figure 17. P_{SAT} vs. Frequency at Various Supply Voltages

13528-017

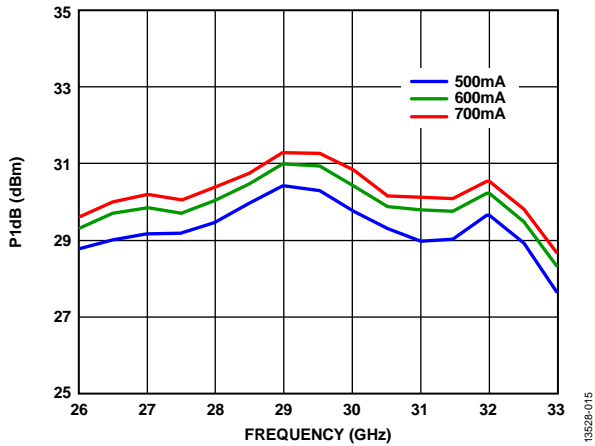

Figure 15. P_{1dB} vs. Frequency at Various Supply Currents (I_{DD})

13528-015

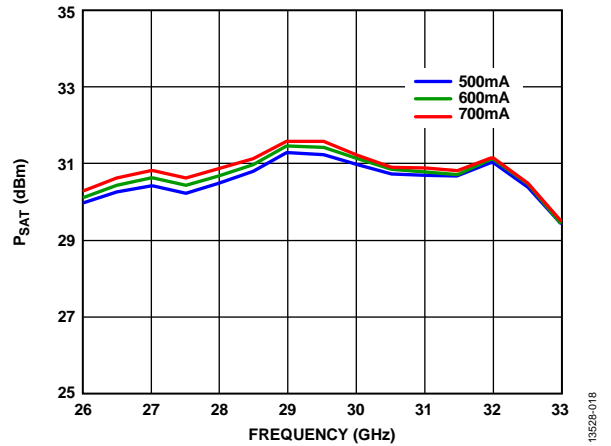

Figure 18. P_{SAT} vs. Frequency at Various Supply Currents (I_{DD})

13528-018

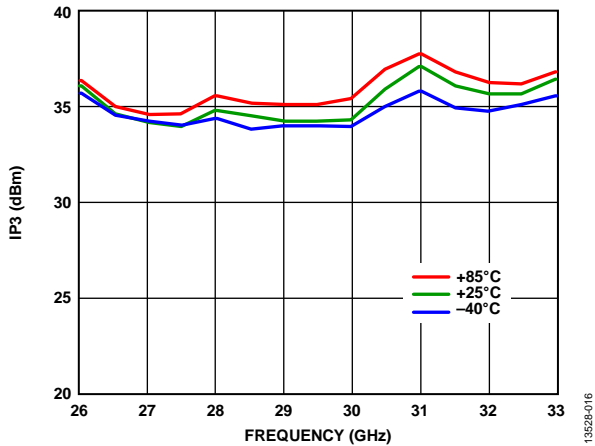

Figure 16. Output IP_3 vs. Frequency at Various Temperatures, $P_{OUT}/Tone = 20$ dBm

13528-016

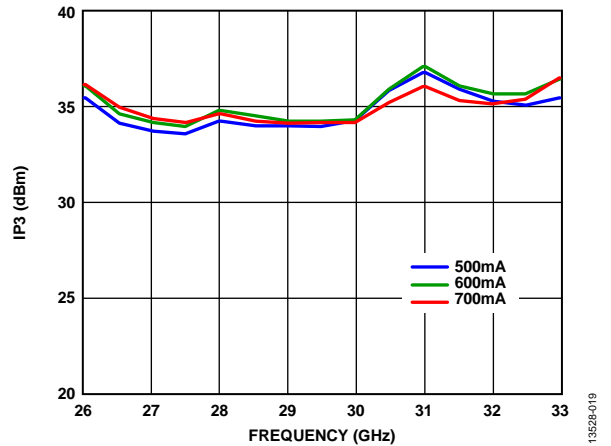

Figure 19. Output IP_3 vs. Frequency at Various Supply Currents, $P_{OUT}/Tone = 20$ dBm

13528-019

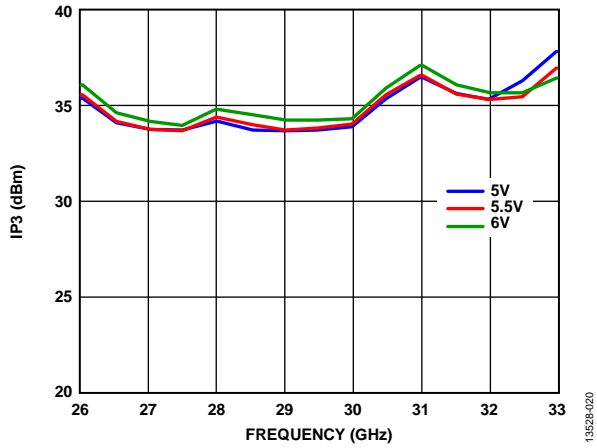

Figure 20. Output IP3 vs. Frequency at Various Supply Voltages, $P_{OUT/TONE} = 20 \text{ dBm}$

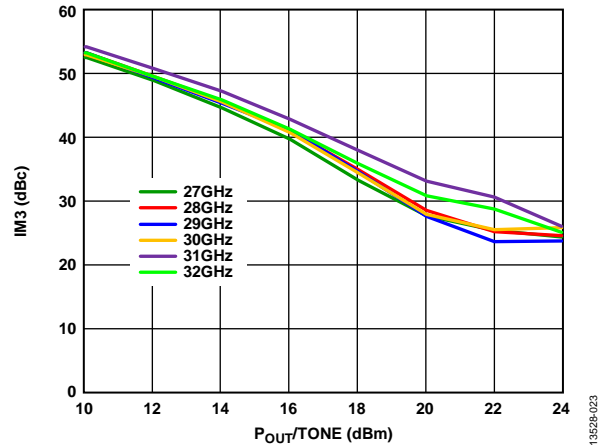

Figure 23. Output IM3 at $V_{DD} = 5 \text{ V}$

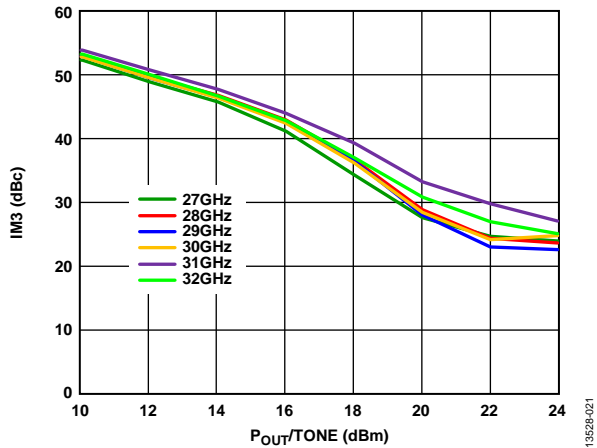

Figure 21. Output Third-Order Intermodulation Distortion (IM3) at $V_{DD} = 5.5 \text{ V}$

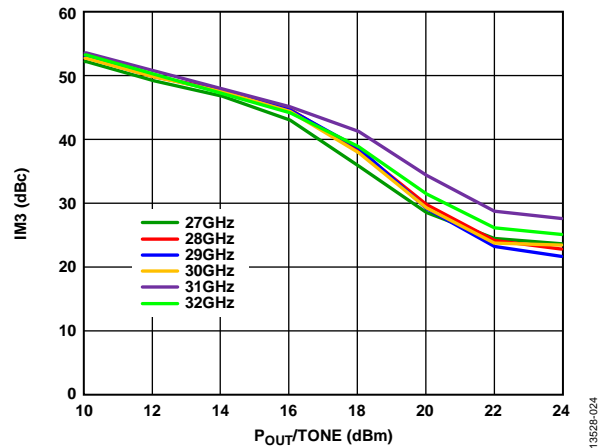

Figure 24. Output IM3 at $V_{DD} = 6 \text{ V}$

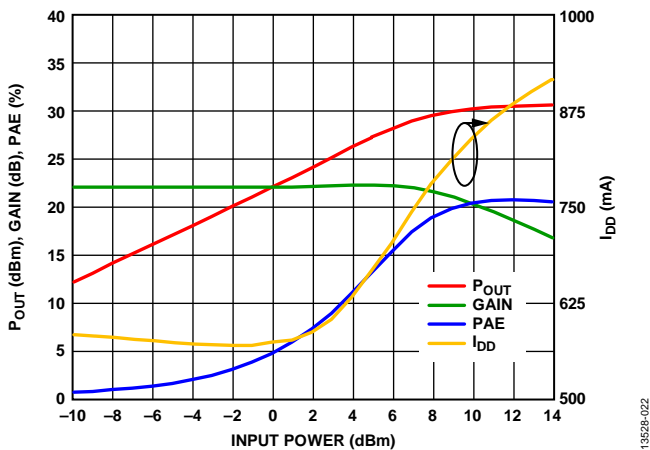

Figure 22. Power Compression at 27 GHz

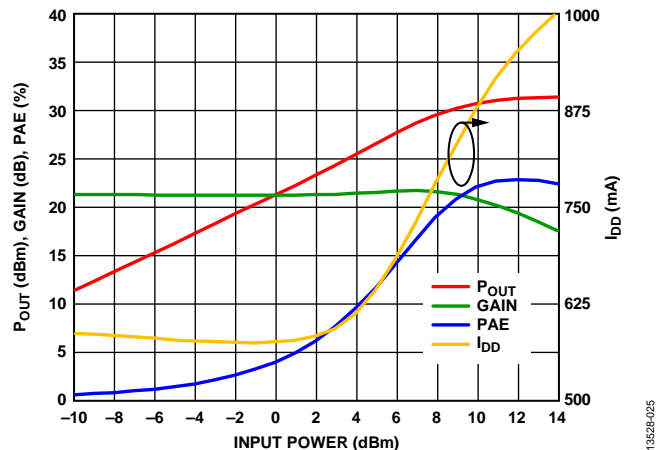

Figure 25. Power Compression at 29.5 GHz

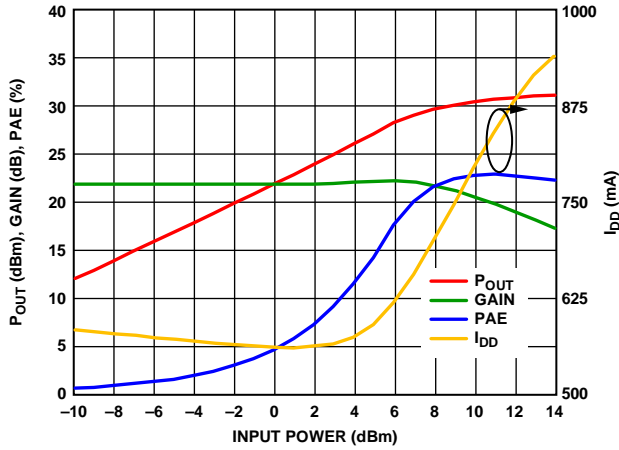

Figure 26. Power Compression at 32 GHz

13528-026

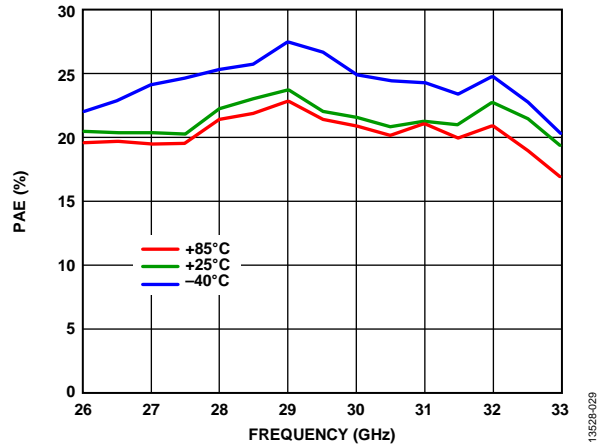

Figure 29. PAE vs. Frequency at Various Temperatures, $P_{IN} = 10$ dBm

13528-029

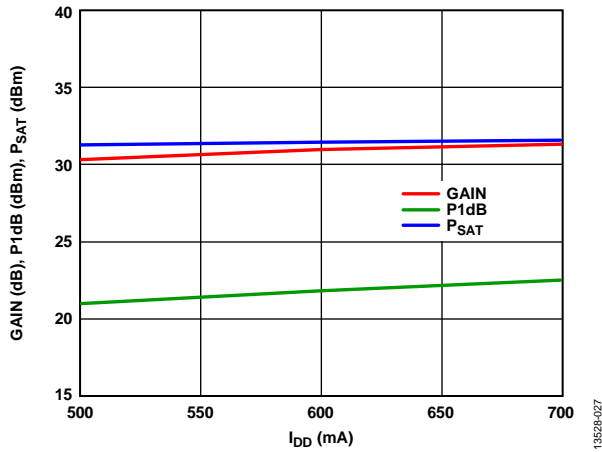

Figure 27. Gain and Power vs. Supply Current at 29.5 GHz

13528-027

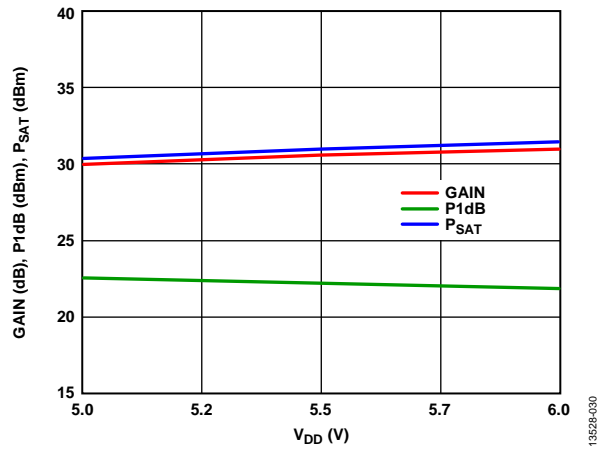

Figure 30. Gain and Power vs. Supply Voltage at 29.5 GHz

13528-030

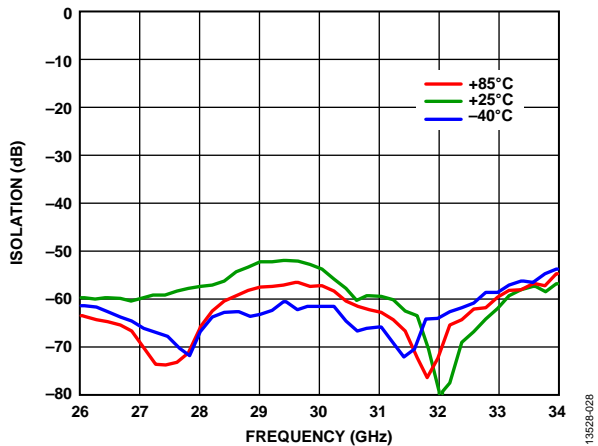

Figure 28. Reverse Isolation vs. Frequency at Various Temperatures

13528-028

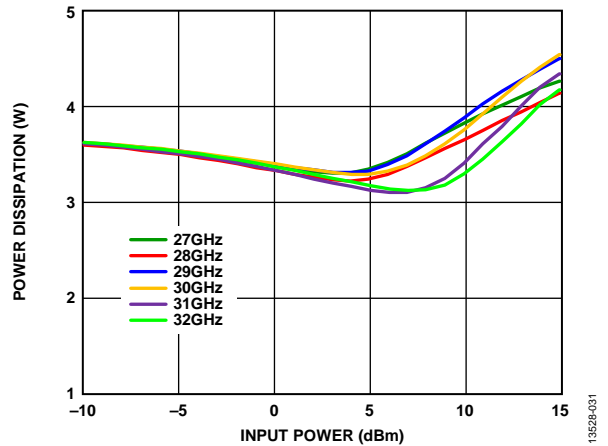

Figure 31. Power Dissipation at 85°C

13528-031

THEORY OF OPERATION

The architecture of the HMC1132 power amplifier is shown in Figure 32. The amplifier consists of a cascade of four, single-stage amplifiers. This approach provides a high P1dB as well as a high gain that is flat across the operating frequency range.

V_{DD1} provides drain bias to the first three gain stages, whereas

V_{DD2} provides drain bias to the fourth gain stage. V_{GG} provides gate bias to all four gain stages, allowing control of the total quiescent drain current. RFIN and RFOUT provide dc paths to GND as a way of increasing the overall ESD robustness of the device.

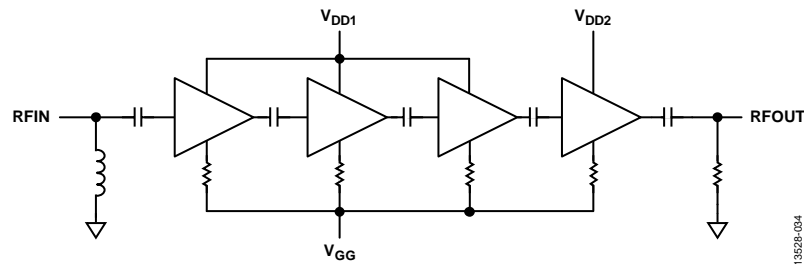

Figure 32. Architecture and Simplified Block Diagram

13528-004

APPLICATIONS INFORMATION

The HMC1132 is a GaAs, pHEMT, MMIC power amplifier. Capacitive bypassing is required for V_{DD1} and V_{DD2} as well as for V_{GG} (see Figure 33). Drain bias voltage must be applied to both V_{DD1} and V_{DD2} , and gate bias voltage must be applied to V_{GG} . Though the RFIN and RFOUT ports ac couple the signal, dc paths to GND are provided to increase the ESD robustness of the device. External dc blocking of RFIN and/or RFOUT is desirable when appreciable levels of dc are expected to be present.

All measurements for this device were taken using the typical application circuit shown in Figure 33, configured as shown on the evaluation printed circuit board (PCB).

The following is the recommended bias sequence during power-up:

1. Connect the evaluation board to ground.
2. Set the gate bias voltage to -2 V.
3. Set the drain bias voltages to 6 V.
4. Increase the gate bias voltage to achieve a quiescent $I_{DD} = 600$ mA.
5. Apply the RF signal.

The following is the recommended bias sequence during power-down:

1. Turn off the RF signal.
2. Decrease the gate bias voltage to -2 V to achieve an $I_{DD} = 0$ mA (approximately).
3. Decrease the drain bias voltages to 0 V.
4. Increase the gate bias voltage to 0 V.

The $V_{DD} = 6$ V and $I_{DD} = 600$ mA bias conditions are the operating points recommended to optimize the overall performance of the device. Unless otherwise noted, the data shown was obtained using the recommended bias condition. Operation of the HMC1132 at different bias conditions may provide performance that differs from what is shown in the Typical Performance Characteristics section. Biasing the HMC1132 for higher drain current typically results in higher P1dB, P_{SAT} , and gain, though at the expense of increased power consumption.

APPLICATION CIRCUIT

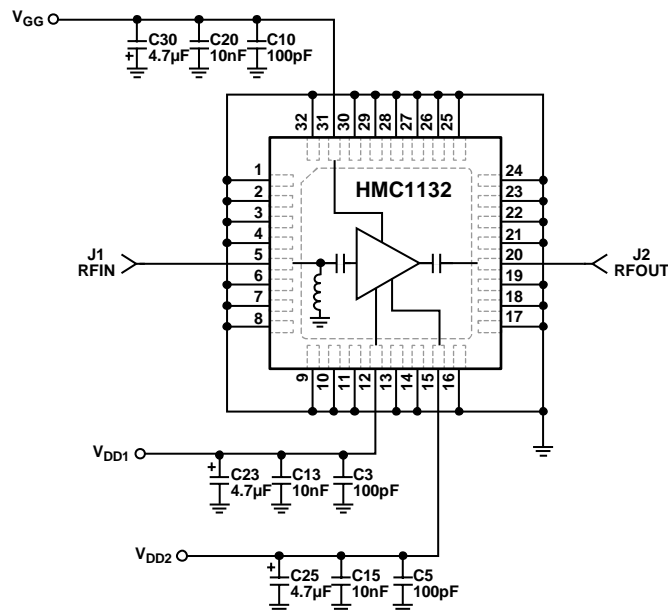

Figure 33. Typical Application Circuit

13528-032

EVALUATION BOARD

The [HMC1132](#) evaluation board is a 2-layer board fabricated using Rogers 4350 and best practices for high frequency RF design. The RF input and RF output traces have a 50 Ω characteristic impedance. The circuit board is attached to a heat sink using SN96 solder and provides a low thermal resistance path. Components are mounted using SN63 solder allowing rework of the surface-mount components without compromising the circuit board to heat sink attachment.

The evaluation board and populated components are designed to operate over the ambient temperature range of -40°C to +85°C. During operation, to control the temperature of the [HMC1132](#), attach the evaluation board to a temperature controlled plate. For proper bias sequence, see the Applications Information section.

The evaluation board schematic is shown in Figure 35. A fully populated and tested evaluation board (see Figure 34), is available from Analog Devices, Inc., upon request.

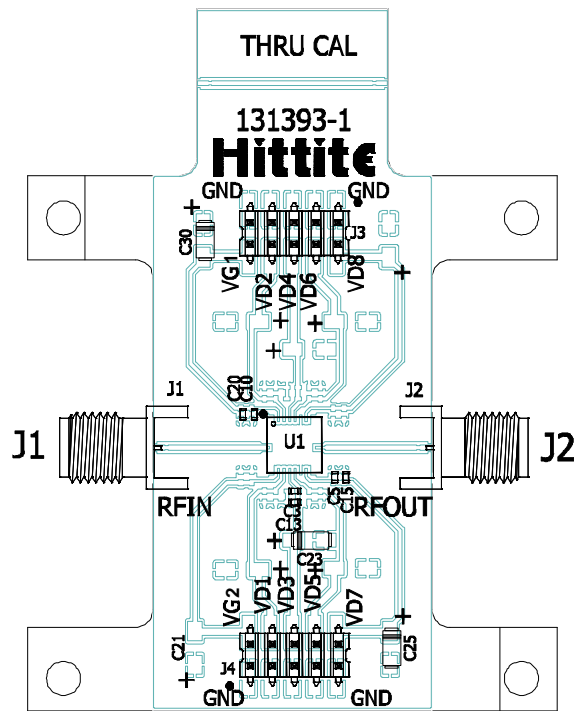

Figure 34. Evaluation Printed Circuit Board (PCB)

BILL OF MATERIALS

Table 4. Bill of Materials for Evaluation PCB EV1HMC1132LP5D

Item	Description
J1, J2	Connector, SRI K connector. SRI PN 25-146-1000-92.
J3, J4	DC pins.
J5, J6	Connector, SRI K connector. Not populated.
C3, C5, C10	100 pF capacitors, 0402 package.
C13, C15, C20	10,000 pF capacitors, 0402 package.
C23, C25, C30	4.7 μF capacitors, Case A package.
U1	HMC1132LP5DE amplifier.
Heat Sink	Used for thermal transfer from the HMC1132LP5DE amplifier.
PCB	131393 evaluation board. Circuit board material: Rogers 4350.

EVALUATION BOARD SCHEMATIC

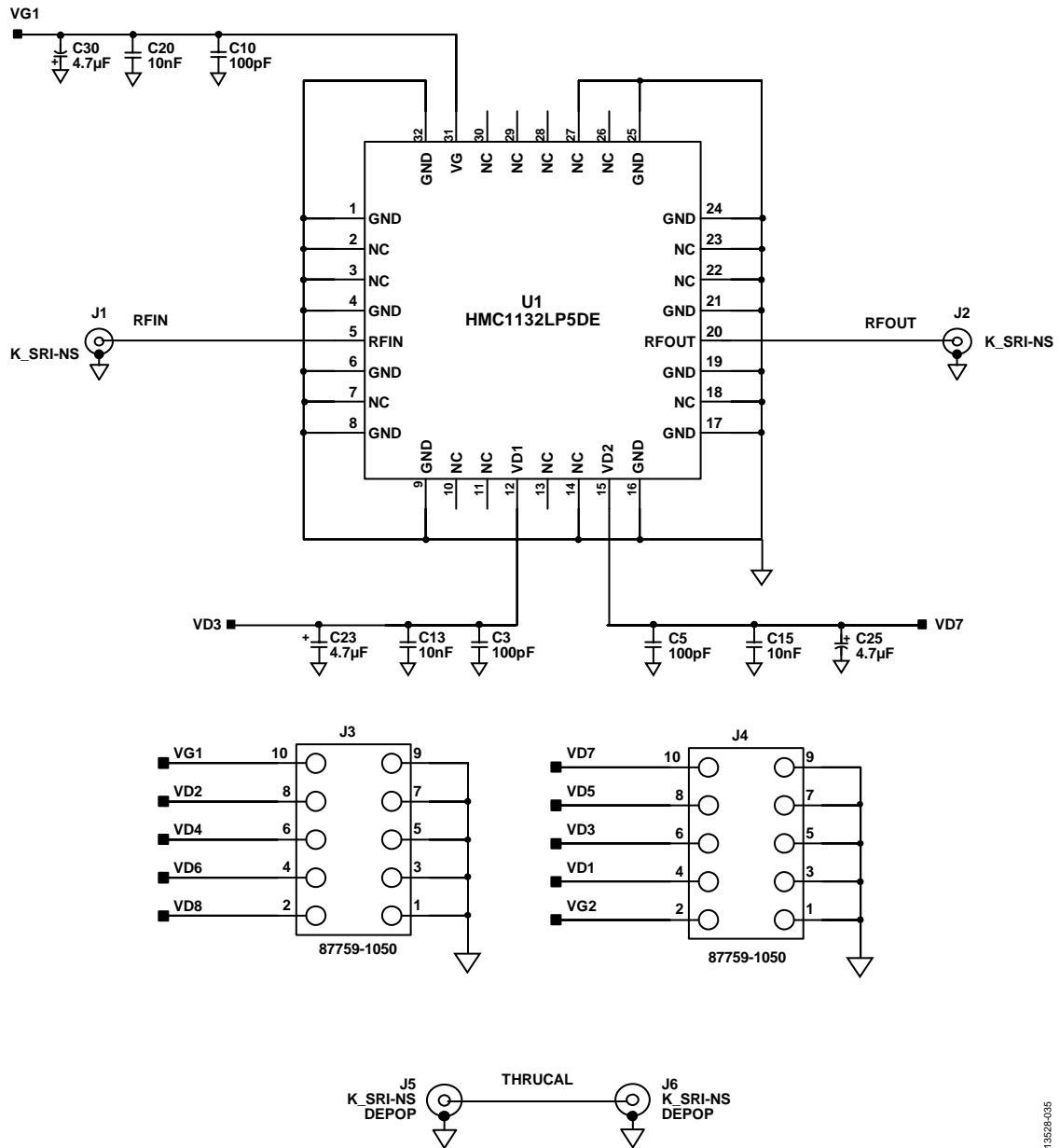

Figure 35. Evaluation Board Schematic

13529-035

OUTLINE DIMENSIONS

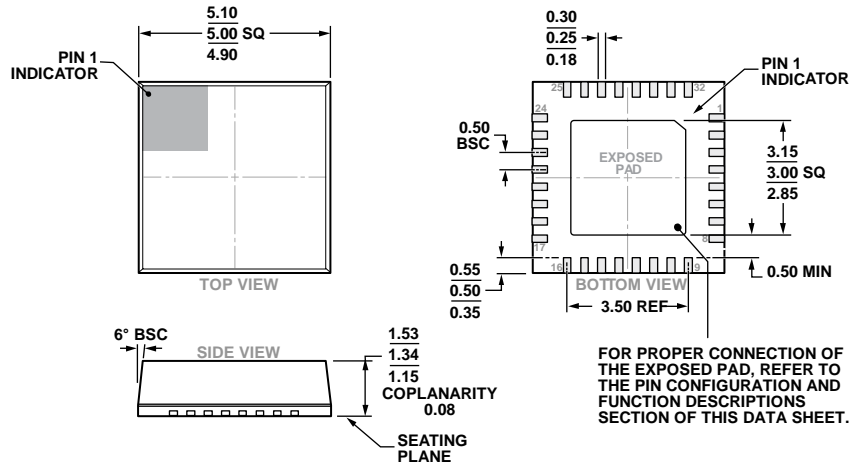

Figure 36. 32-Lead Lead Frame Chip Scale Package [LFCSP]
 5 mm × 5 mm Body and 1.34 mm Package Height
 (HCP-32-2)
 Dimensions shown in millimeters

ORDERING GUIDE

Model ¹	Temperature Range	MSL Rating ²	Package Description ^{3, 4}	Package Option	Package Marking ⁵
HMC1132LP5DE	-40°C to +85°C	MSL3	32-Lead Lead Frame Chip Scale Package [LFCSP]	HCP-32-2	H1132 XXXX
HMC1132LP5DETR	-40°C to +85°C	MSL3	32-Lead Lead Frame Chip Scale Package [LFCSP]	HCP-32-2	H1132 XXXX
EV1HMC1132LP5D			Evaluation board		

¹ When ordering the evaluation fixture only, reference the model number, EV1HMC1132LP5D.

² Maximum peak reflow temperature of 260°C.

³ HMC1132LP5DE lead finish is NiPdAu.

⁴ The HMC1132LP5DE is a premolded copper alloy lead frame.

⁵ HMC1132LP5DE 4-digit lot number is represented by XXXX.

X-ON Electronics

Largest Supplier of Electrical and Electronic Components

Click to view similar products for [RF Amplifier](#) category:

Click to view products by [Analog Devices](#) manufacturer:

Other Similar products are found below :

[A82-1](#) [BGA622H6820XTSA1](#) [BGA 728L7 E6327](#) [BGB719N7ESDE6327XTMA1](#) [HMC397-SX](#) [HMC405](#) [HMC561-SX](#) [HMC8120-SX](#)
[HMC8121-SX](#) [HMC-ALH382-SX](#) [HMC-ALH476-SX](#) [SE2433T-R](#) [SMA3101-TL-E](#) [SMA39](#) [A66-1](#) [A66-3](#) [A67-1](#) [A81-2](#) [LX5535LQ](#)
[LX5540LL](#) [MAAM02350](#) [HMC3653LP3BETR](#) [HMC549MS8GETR](#) [HMC-ALH435-SX](#) [SMA101](#) [SMA32](#) [SMA411](#) [SMA531](#)
[SST12LP19E-QX6E](#) [WPM0510A](#) [HMC5929LS6TR](#) [HMC5879LS7TR](#) [HMC1087F10](#) [HMC1086](#) [HMC1016](#) [SMA1212](#) [MAX2689EWS+T](#)
[MAAMSS0041TR](#) [MAAM37000-A1G](#) [LTC6430AIUF-15#PBF](#) [SMA70-2](#) [SMA4011](#) [A231](#) [HMC-AUH232](#) [LX5511LQ](#) [LX5511LQ-TR](#)
[HMC7441-SX](#) [HMC-ALH310](#) [XD1001-BD-000V](#) [A4011](#)