



### Typical Applications

The HMC194AMS8 /HMC194AMS8E is ideal for:

- Cellular/PCS Base Stations
- Portable Wireless
- MMDS & WirelessLAN

### Features

- Ultra Small Package: MSOP8
- High Isolation: 50 dB
- Positive Control: 0/+3V to 0/+7V

### Functional Diagram

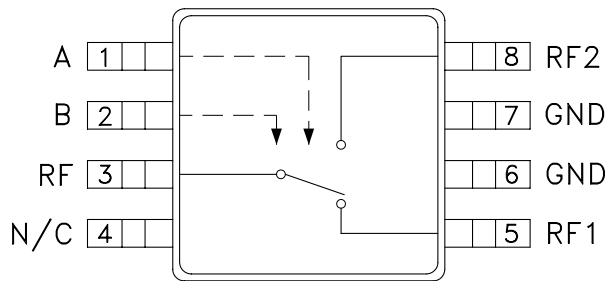

### General Description

The HMC194AMS8 & HMC194AMS8E are low-cost SPDT switches in 8-lead MSOP packages for use in applications which require high isolation between two RF paths. The devices can control signals from DC to 3 GHz and have been optimized to provide extremely high isolation with minimal insertion loss in medium and low power applications. On chip circuitry allows positive voltage control operation at very low DC currents with control inputs compatible with CMOS and most TTL logic families. RF1 and RF2 are reflective opens when "OFF".

### Electrical Specifications, $T_A = +25^\circ C$ , $V_{ctl} = 0/+5 Vdc$ , 50 Ohm System

| Parameter   | Frequency     | Min.  | Typ. | Max.    | Units    |
|---|---------------|---|------|---------|----------|
| Insertion Loss  | DC - 2.0 GHz  |   | 0.5  | 0.9     | dB       |
|   | DC - 2.5 GHz  |   | 0.5  | 1.0     | dB       |
|   | DC - 3.0 GHz  |   | 0.5  | 1.1     | dB       |
| Isolation   | DC - 1.0 GHz  | 50  | 55   |         | dB       |
|   | DC - 2.0 GHz  | 42  | 45   |         | dB       |
|   | DC - 2.5 GHz  | 31  | 38   |         | dB       |
|   | DC - 3.0 GHz  | 24  | 30   |         | dB       |
| Return Loss   | DC - 2.0 GHz  |   | 26   |         | dB       |
|   | DC - 3.0 GHz  |   | 24   |         | dB       |
| Input Power for 1 dB Compression<br>0/+5V Control   | 0.5 - 3.0 GHz | 24  | 28   |         | dBm      |
| Input Third Order Intercept<br>(Two-tone Input Power = +7 dBm Each Tone)<br>0/+5V Control | 0.5 - 3.0 GHz | 49  | 53   |         | dBm      |
| Switching Characteristics   | DC - 3.0 GHz  |   |      |         |          |
|   |               | tRISE, tFALL (10/90% RF)<br>tON , tOFF (50% CTL to 10/90% RF) |      | 3<br>20 | ns<br>ns |

Information furnished by Analog Devices is believed to be accurate and reliable. However, no responsibility is assumed by Analog Devices for its use, nor for any infringements of patents or other rights of third parties that may result from its use. Specifications subject to change without notice. No license is granted by implication or otherwise under any patent or patent rights of Analog Devices. Trademarks and registered trademarks are the property of their respective owners.

For price, delivery, and to place orders: Analog Devices, Inc., One Technology Way, P.O. Box 9106, Norwood, MA 02062-9106  
Phone: 781-329-4700 • Order online at [www.analog.com](http://www.analog.com)  
Application Support: Phone: 1-800-ANALOG-D



## GaAs MMIC SPDT SWITCH DC - 3 GHz

### Insertion Loss

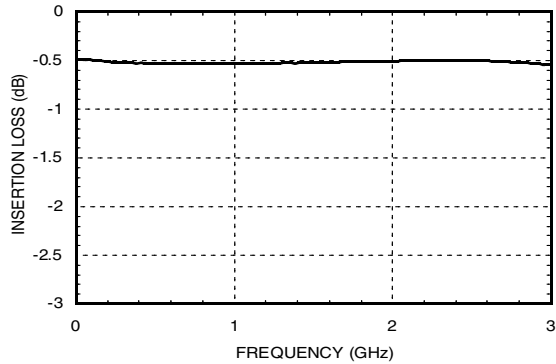

### Isolation

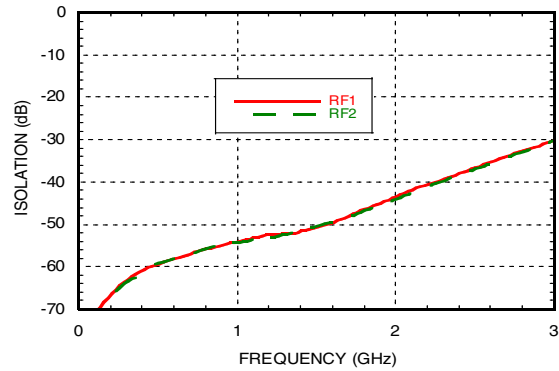

### Return Loss

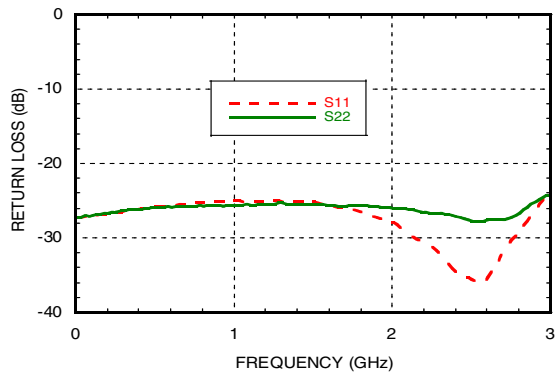

### Input 0.1 and 1.0 dB Compression vs. Control Voltage

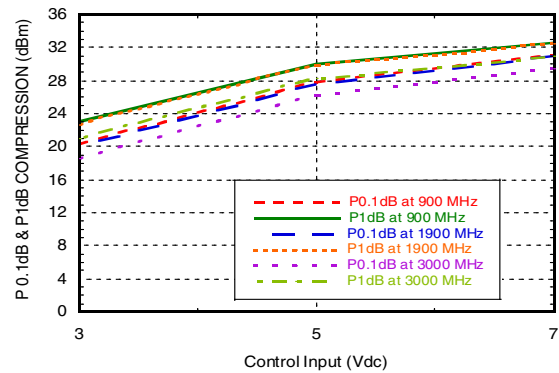

### Input Third Order Intercept Point vs. Control Voltage

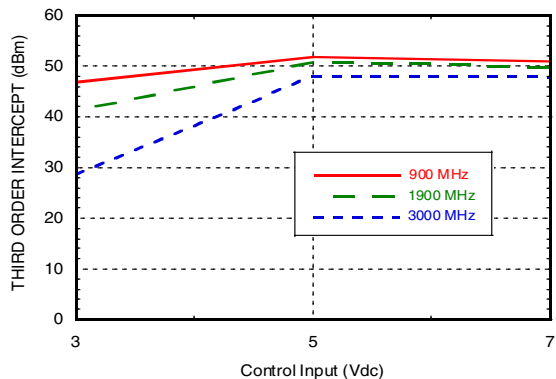

### Truth Table

\*Control Input Voltage Tolerances are ± 0.2 Vdc.

| Control Input* |         | Control Current |         | Signal Path State |           |
|----------------|---------|-----------------|---------|-------------------|-----------|
| A (Vdc)        | B (Vdc) | Ia (uA)         | Ib (uA) | RF to RF1         | RF to RF2 |
| 0              | +3      | -0.05           | +0.05   | ON                | OFF       |
| +3             | 0       | +0.05           | -0.05   | OFF               | ON        |
| 0              | +5      | -0.6            | +0.6    | ON                | OFF       |
| +5             | 0       | +0.6            | -0.6    | OFF               | ON        |
| 0              | +7      | -5              | +5      | ON                | OFF       |
| +7             | 0       | +5              | -5      | OFF               | ON        |

Information furnished by Analog Devices is believed to be accurate and reliable. However, no responsibility is assumed by Analog Devices for its use, nor for any infringements of patents or other rights of third parties that may result from its use. Specifications subject to change without notice. No license is granted by implication or otherwise under any patent or patent rights of Analog Devices. Trademarks and registered trademarks are the property of their respective owners.

For price, delivery, and to place orders: Analog Devices, Inc., One Technology Way, P.O. Box 9106, Norwood, MA 02062-9106 Phone: 781-329-4700 • Order online at [www.analog.com](http://www.analog.com) Application Support: Phone: 1-800-ANALOG-D



## GaAs MMIC SPDT SWITCH DC - 3 GHz

### Absolute Maximum Ratings

|   |                  |
|---|------------------|
| RF Input Power (Vctl= 0V/+5V)   | +27 dBm          |
| Control Voltage Range (A & B)   | -0.2 to +7.5 Vdc |
| Hot Switch Power Level (Vctl= 0V/+5V)                                     | +24 dBm          |
| Channel Temperature   | 150 °C           |
| Continuous P <sub>diss</sub> (T= 85 °C)<br>(derate 4.6 mW/°C above 85 °C) | 300 mW           |
| Thermal Resistance  | 216 °C/W         |
| Storage Temperature   | -65 to +150 °C   |
| Operating Temperature   | -40 to +85 °C    |
| ESD Sensitivity (HBM)   | Class 1A         |

Note: DC blocking capacitors are required at ports RFC, RF1 and RF2. Their value will determine the lowest transmission frequency.



ELECTROSTATIC SENSITIVE DEVICE  
OBSERVE HANDLING PRECAUTIONS

### Outline Drawing

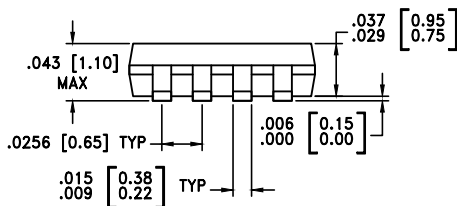
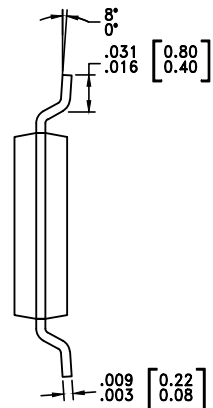
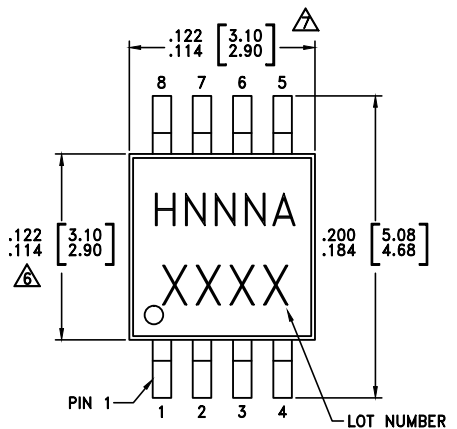

NOTES:

- LEADFRAME MATERIAL: COPPER ALLOY
- DIMENSIONS ARE IN INCHES [MILLIMETERS].
- DIMENSION DOES NOT INCLUDE MOLDFLASH OF 0.15mm PER SIDE.
- DIMENSION DOES NOT INCLUDE MOLDFLASH OF 0.25mm PER SIDE.
- ALL GROUND LEADS MUST BE SOLDERED TO PCB RF GROUND.
- CLASSIFIED AS MOISTURE SENSITIVITY LEVEL (MSL) 1.

### Package Information

| Part Number | Package Body Material                              | Lead Finish   | MSL Rating          | Package Marking <sup>[3]</sup> |
|-------------|--|---------------|---------------------|--------------------------------|
| HMC194AMS8  | Low Stress Injection Molded Plastic                | Sn/Pb Solder  | MSL1 <sup>[1]</sup> | H194A<br>XXXX                  |
| HMC194AMS8E | RoHS-compliant Low Stress Injection Molded Plastic | 100% matte Sn | MSL1 <sup>[2]</sup> | <u>H194A</u><br>XXXX           |

[1] Max peak reflow temperature of 235 °C

[2] Max peak reflow temperature of 260 °C

[3] 4-Digit lot number XXXX



**GaAs MMIC SPDT SWITCH  
DC - 3 GHz**

**Typical Application Circuit**

Notes:

1. Set logic gate and switch Vdd = +3V to +5V and use HCT series logic to provide a TTL driver interface.
2. Control inputs A/B can be driven directly with CMOS logic (HC) with Vdd of 3 to 7 Volts applied to the CMOS logic gates.
3. DC Blocking capacitors are required for each RF port as shown. Capacitor value determines lowest frequency of operation.
4. Highest RF signal power capability is achieved with Control set to 0/+7V.

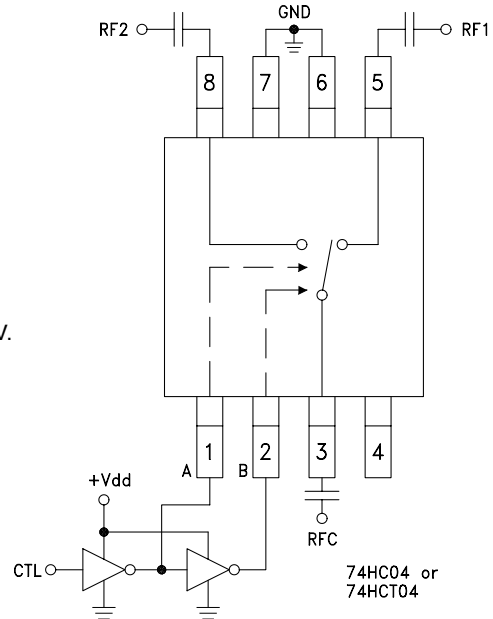

**Evaluation Circuit Board**

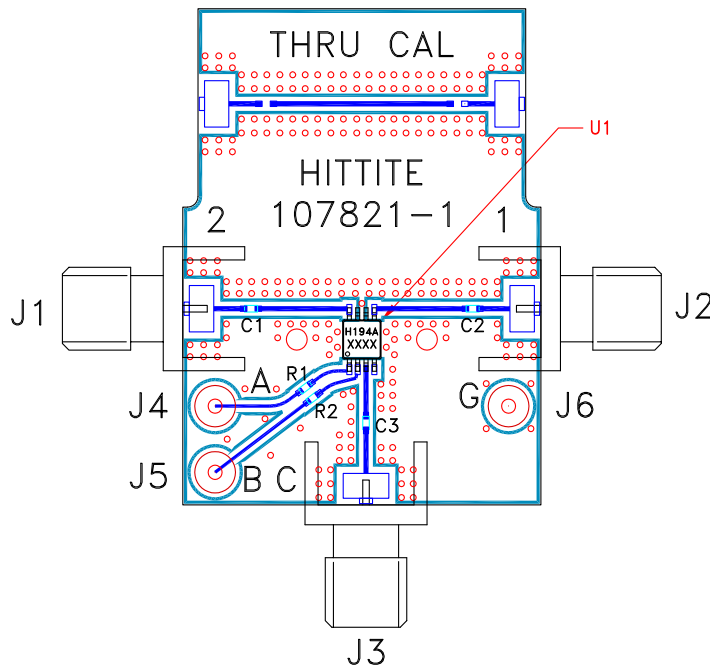

**List of Materials for  
Evaluation PCB 105143 [1]**

| Item    | Description                       |
|---------|-----------------------------------|
| J1 - J3 | PC Mount SMA RF Connector         |
| J4 - J6 | DC Pin                            |
| C1 - C3 | 100 pF capacitor, 0402 Pkg.       |
| R1, R2  | 100 Ω resistor, 0402 Pkg.         |
| U1      | HMC194AMS8 / 194AMS8E SPDT Switch |
| PCB [2] | 107821 Evaluation PCB             |

[1] Reference this number when ordering complete evaluation PCB

[2] Circuit Board Material: Rogers 4350

The circuit board used in the final application should be generated with proper RF circuit design techniques. Signal lines at the RF port should have 50 Ohm impedance and the package ground leads should be connected directly to the ground plane similar to that shown above. The evaluation circuit board shown above is available from Hittite Microwave Corporation upon request.

## X-ON Electronics

Largest Supplier of Electrical and Electronic Components

*Click to view similar products for [RF Switch ICs](#) category:*

*Click to view products by [Analog Devices](#) manufacturer:*

Other Similar products are found below :

[MASW-008853-TR3000](#) [BGS13SN8E6327XTSA1](#) [BGSX210MA18E6327XTSA1](#) [SKY13446-374LF](#) [SW-227-PIN](#) [CG2185X2](#) [CG2415M6](#)  
[MA4SW410B-1](#) [MASW-002102-13580G](#) [MASW-008543-001SMB](#) [MASW-008955-TR3000](#) [TGS4307](#) [BGS 12PL6 E6327](#)  
[BGS1414MN20E6327XTSA1](#) [BGS1515MN20E6327XTSA1](#) [BGSA11GN10E6327XTSA1](#) [BGSX28MA18E6327XTSA1](#) [HMC199AMS8](#)  
[SKY13374-397LF](#) [SKY13453-385LF](#) [CG2415M6-C2](#) [HMC986A-SX](#) [SW-314-PIN](#) [UPG2162T5N-E2-A](#) [SKY13416-485LF](#)  
[MASWSS0204TR-3000](#) [MASWSS0201TR](#) [MASWSS0181TR-3000](#) [MASW-007588-TR3000](#) [MASW-004103-13655P](#) [MASW-003102-](#)  
[13590G](#) [MASWSS0202TR-3000](#) [MA4SW310B-1](#) [MA4SW110](#) [SW-313-PIN](#) [CG2430X1](#) [SKY13321-360LF](#) [SKY13405-490LF](#)  
[SKYA21001](#) [BGSF 18DM20 E6327](#) [SKY13415-485LF](#) [MMS008PP3](#) [BGS13PN10E6327XTSA1](#) [SKY13319-374LF](#)  
[BGS14PN10E6327XTSA1](#) [SKY12213-478LF](#) [SKY13404-466LF](#) [MASW-011060-TR0500](#) [SKYA21024](#) [SKY85601-11](#)