



GaAs MMIC MIXER w/ INTEGRATED LO AMPLIFIER, 3.0 - 3.8 GHz

Typical Applications

The HMC333 / HMC333E is ideal for:

- Wireless Local Loop

Features

- Integrated LO Amplifier w/ Pdiss: < 25 mW
- Conversion Loss / Noise Figure: 8.5 dB
- Low LO Drive Level: 0 dBm
- Input IP3: +10 dBm
- Single Positive Supply: 3V to 5V

Functional Diagram

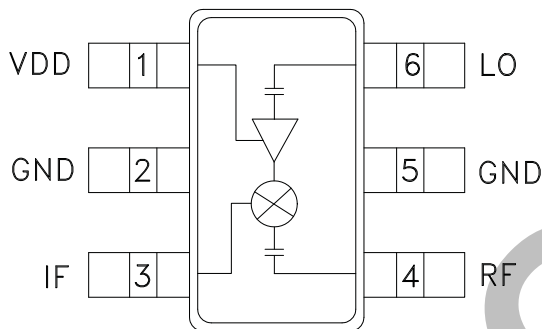

General Description

The HMC333 & HMC333E are single balanced mixer ICs with integrated LO amplifiers. This converter IC can operate as an upconverter or downconverter between 3.0 GHz and 3.8 GHz. With the integrated LO amplifier, the mixer requires an LO drive level of only 0 dBm, and requires only 7 mA from a single positive +3V rail. The mixer has 8.5 dB of conversion loss, an input P1dB of 0 dBm and an input third order intercept point of +10 dBm at 3.5 GHz.

Electrical Specifications, $T_A = +25^\circ C$

Parameter	IF = 100 MHz LO = 0 dBm & Vdd = +3V			Units
	Min.	Typ.	Max.	
Frequency Range, RF & LO	3.0 - 3.8			GHz
Frequency Range, IF	DC - 1.0			GHz
Conversion Loss		8.5	11	dB
Noise Figure (SSB)		8.5	11	dB
LO to RF Isolation	10	15		dB
LO to IF Isolation	5	10		dB
RF to IF Isolation	10	15		dB
IP3 (Input)	3	10		dBm
1 dB Compression (Input)	-3	+1		dBm
Supply Current (Idd)		7		mA

* Unless otherwise noted, all measurements performed as downconverter, IF= 100 MHz.



GaAs MMIC MIXER w/ INTEGRATED LO AMPLIFIER, 3.0 - 3.8 GHz

Conversion Gain vs. Temperature @ LO = 0 dBm

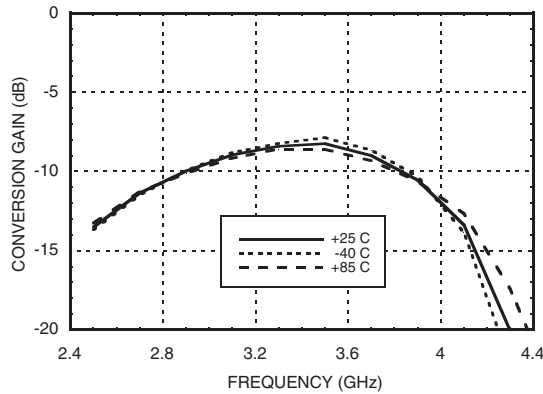

Isolation @ LO = 0 dBm

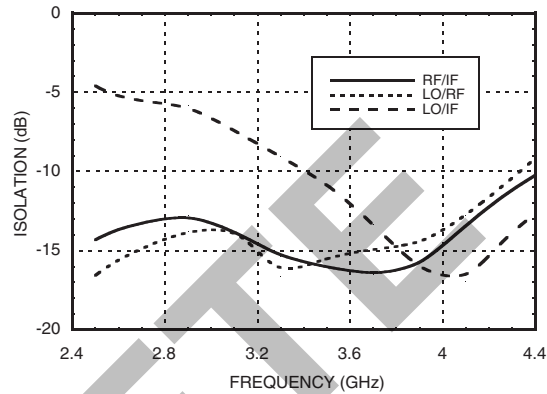

Conversion Gain vs. LO Drive

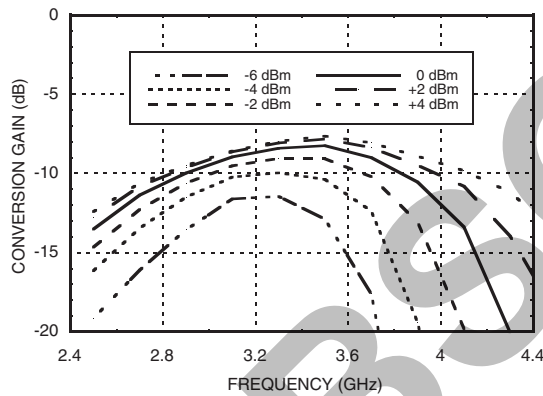

Return Loss @ LO = 0 dBm

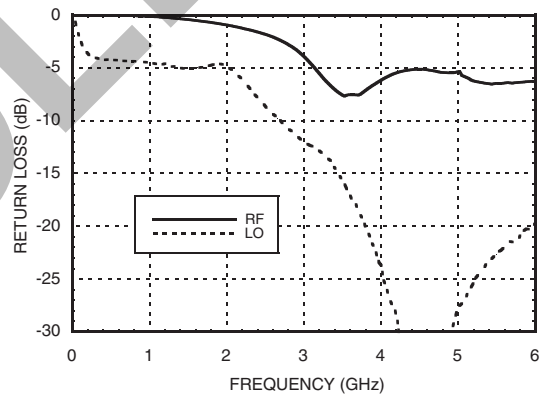

Conversion Gain vs. Vdd @ LO = 0 dBm

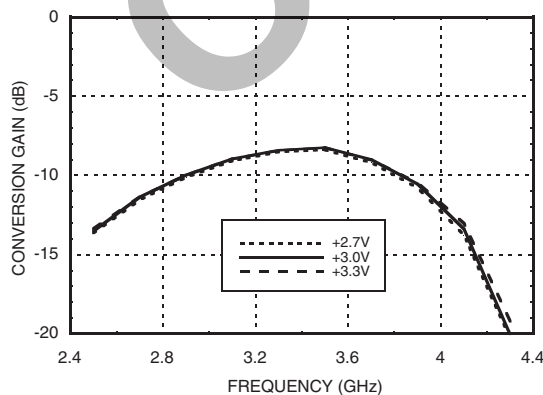

IF Bandwidth @ LO = 0 dBm

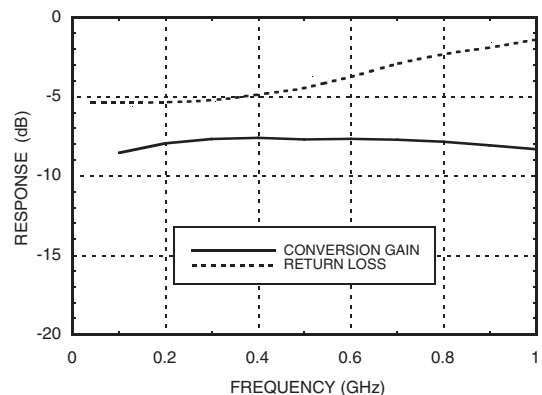

Information furnished by Analog Devices is believed to be accurate and reliable. However, no responsibility is assumed by Analog Devices for its use, nor for any infringements of patents or other rights of third parties that may result from its use. Specifications subject to change without notice. No license is granted by implication or otherwise under any patent or patent rights of Analog Devices. Trademarks and registered trademarks are the property of their respective owners.

For price, delivery, and to place orders: Analog Devices, Inc., One Technology Way, P.O. Box 9106, Norwood, MA 02062-9106 Phone: 781-329-4700 • Order online at www.analog.com Application Support: Phone: 1-800-ANALOG-D



GaAs MMIC MIXER w/ INTEGRATED LO AMPLIFIER, 3.0 - 3.8 GHz

**Upconverter Performance
Conversion Gain @ LO = 0 dBm**

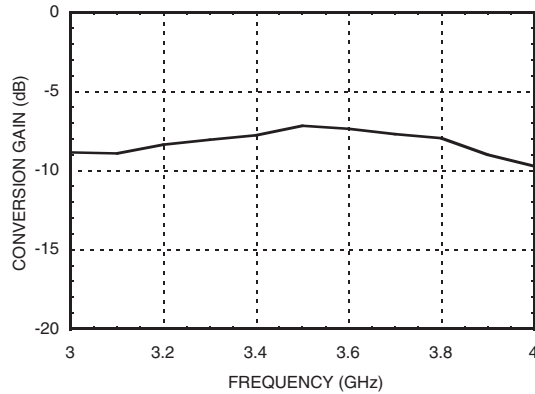

**Input P1dB vs.
Temperature @ LO = 0 dBm**

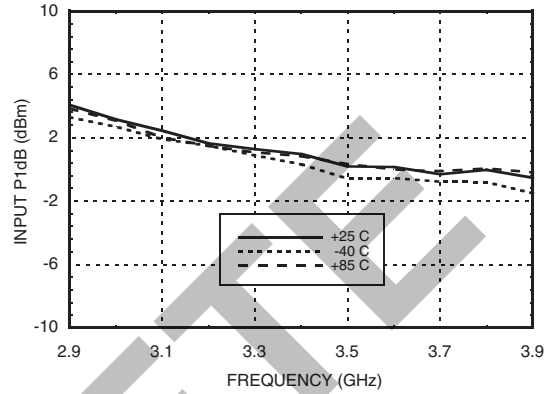

Input IP3 vs. LO Drive*

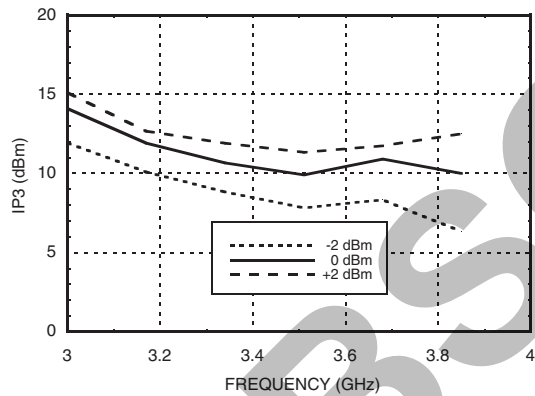

**Input IP3 vs.
Temperature @ LO = 0 dBm***

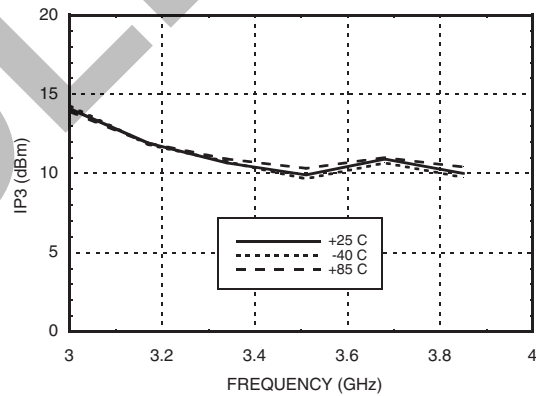

Input IP3 vs. Vdd @ LO = 0 dBm*

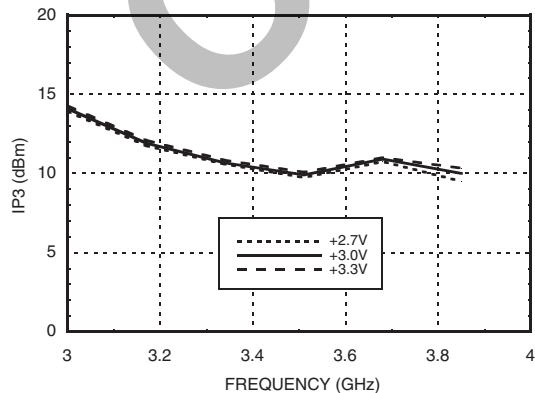

Input P1dB vs. Vdd @ LO = 0 dBm

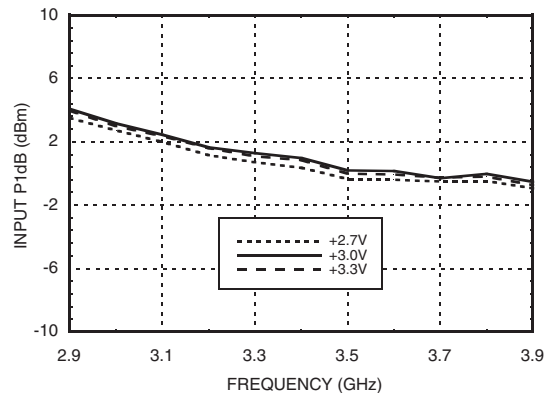

* Two-tone input power = -10 dBm each tone, 1 MHz spacing.

GaAs MMIC MIXER w/ INTEGRATED LO AMPLIFIER, 3.0 - 3.8 GHz



MxN Spurious @ IF Port

mRF	nLO				
	0	1	2	3	4
0	xx	-9	-5	12	34
1	8	0	32	25	34
2	33	49	40	40	43
3	68	56	68	48	72
4	77	80	79	80	71

RF = 3.5 GHz @ -10 dBm
 LO = 3.4 GHz @ 0 dBm
 All values in dBc below IF power level.

Harmonics of LO

LO Freq. (GHz)	nLO Spur @ RF Port			
	1	2	3	4
3	12	8	16	49
3.17	13	8	20	39
3.34	17	10	22	42
3.51	15	14	26	48
3.68	14	17	25	42
3.85	14	18	22	43

LO = 0 dBm
 All values in dBc below input LO level @ RF port.

OBSOLETE



**GaAs MMIC MIXER w/ INTEGRATED
LO AMPLIFIER, 3.0 - 3.8 GHz**

Absolute Maximum Ratings

RF / IF Input (Vdd = +3V)	+13 dBm
LO Drive (Vdd = +3V)	+13 dBm
Vdd	5.5V
Continuous P _{diss} (T _a = 85 °C) (derate 2.64 mW/°C above 85 °C)	238 mW
IF DC Current	±3 mA
Storage Temperature	-65 to +150 °C
Operating Temperature	-40 to +85 °C



**ELECTROSTATIC SENSITIVE DEVICE
OBSERVE HANDLING PRECAUTIONS**

Outline Drawing

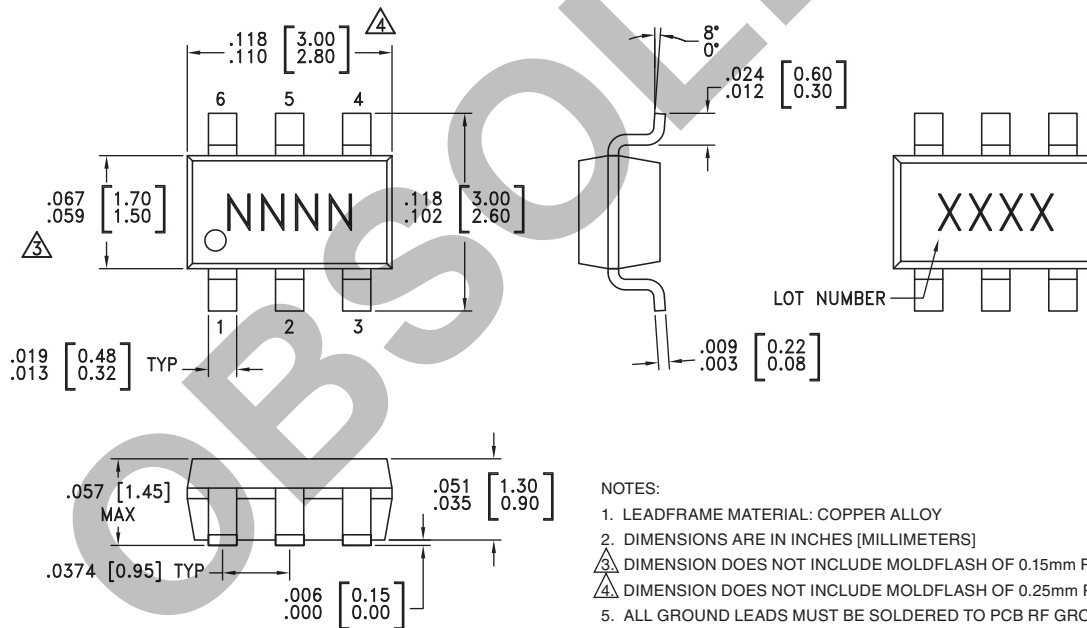

Package Information

Part Number	Package Body Material	Lead Finish	MSL Rating	Package Marking ^[3]
HMC333	Low Stress Injection Molded Plastic	Sn/Pb Solder	MSL1 ^[1]	H333 XXXX
HMC333E	RoHS-compliant Low Stress Injection Molded Plastic	100% matte Sn	MSL1 ^[2]	333E XXXX

[1] Max peak reflow temperature of 235 °C

[2] Max peak reflow temperature of 260 °C

[3] 4-Digit lot number XXXX

Information furnished by Analog Devices is believed to be accurate and reliable. However, no responsibility is assumed by Analog Devices for its use, nor for any infringements of patents or other rights of third parties that may result from its use. Specifications subject to change without notice. No license is granted by implication or otherwise under any patent or patent rights of Analog Devices. Trademarks and registered trademarks are the property of their respective owners.

For price, delivery, and to place orders: Analog Devices, Inc., One Technology Way, P.O. Box 9106, Norwood, MA 02062-9106
Phone: 781-329-4700 • Order online at www.analog.com
Application Support: Phone: 1-800-ANALOG-D

GaAs MMIC MIXER w/ INTEGRATED LO AMPLIFIER, 3.0 - 3.8 GHz



Pin Descriptions

Pin Number	Function	Description	Interface Schematic
1	Vdd	Power supply for the LO Amplifier. Two external RF bypass capacitors (10 pF & 10,000 pF) and an external inductor (1.8 nH) are required.	
2, 5	GND	Ground: Pin must connect to RF ground.	
3	IF	This pin is DC coupled. For applications not requiring operation to DC, this port should be DC blocked externally using a series capacitor whose value has been chosen to pass the necessary IF frequency range. For operation to DC, this pin must not source/sink more than 3mA of current or die non-function and possible die failure will result.	
4	RF	This pin is AC coupled and matched to 50 Ohm from 3.0 - 3.8 GHz.	
6	LO	This pin is AC coupled and matched to 50 Ohm from 3.0 - 3.8 GHz	

OBSOLETE



**GaAs MMIC MIXER w/ INTEGRATED
LO AMPLIFIER, 3.0 - 3.8 GHz**

Application Circuit

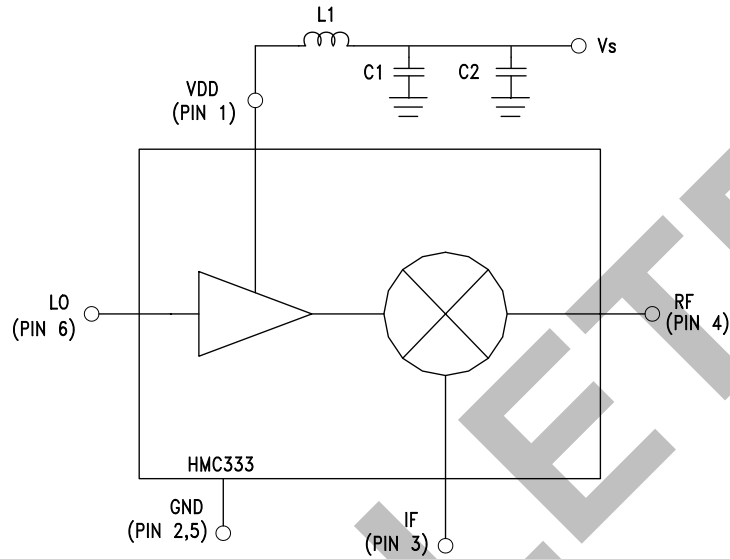

OBSOLETE

GaAs MMIC MIXER w/ INTEGRATED LO AMPLIFIER, 3.0 - 3.8 GHz



Evaluation PCB

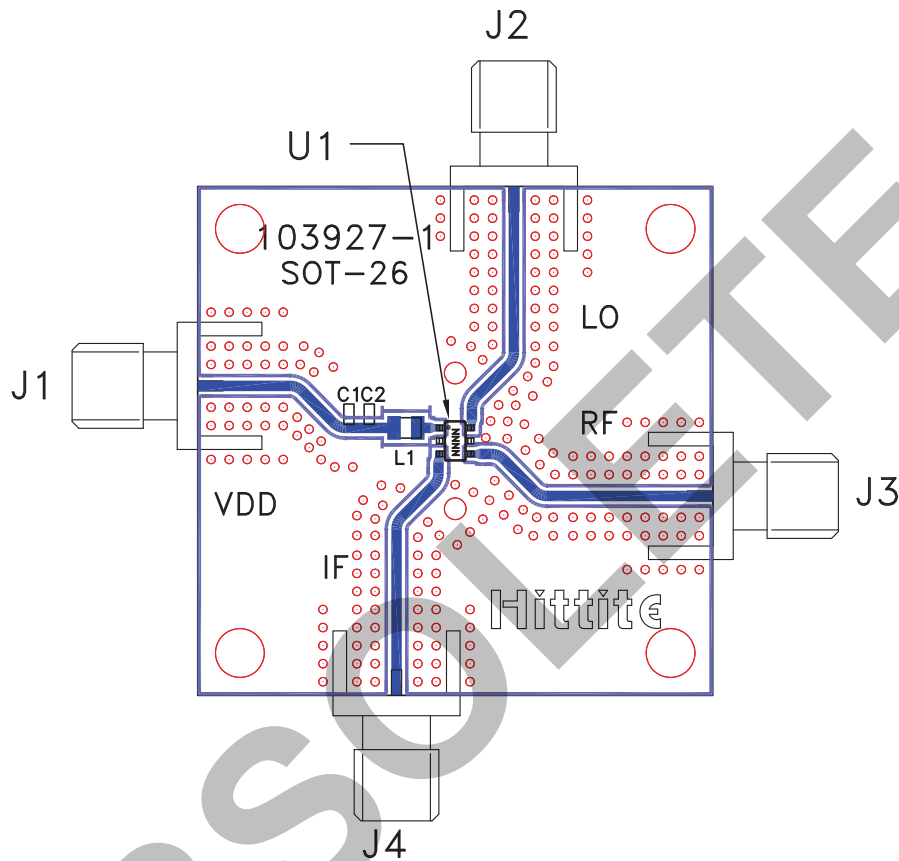

List of Materials for Evaluation PCB 105128 [1]

Item	Description
J1 - J4	PCB Mount SMA RF Connector
C1	10 pF Capacitor, 0603 Pkg.
C2	.01 μ F Capacitor, 0603 Pkg.
L1	1.8 nH Inductor, 0805 Pkg.
U1	HMC333 / HMC333E Mixer
PCB [2]	103927 Evaluation Board

[1] Reference this number when ordering complete evaluation PCB

[2] Circuit Board Material: Rogers 4350

The circuit board used in the final application should use RF circuit design techniques. Signal lines should have 50 ohm impedance while the package ground leads should be connected directly to the ground plane similar to that shown. A sufficient number of via holes should be used to connect the top and bottom ground planes. The evaluation circuit board shown is available from Hittite upon request.

X-ON Electronics

Largest Supplier of Electrical and Electronic Components

Click to view similar products for [RF Mixer](#) category:

Click to view products by [Analog Devices](#) manufacturer:

Other Similar products are found below :

[M80C](#) [HMC337-SX](#) [F1763EVBI](#) [mamx-009646-23dbml](#) [HMC339-SX](#) [F1751NBGI](#) [CSM5T](#) [CHR3664-QEG](#) [NJM2552V-TE1](#)
[HMC220BMS8GE](#) [HMC8192-SX](#) [LTC5569IUF#PBF](#) [HMC220BMS8GETR](#) [MAX2055EUP+TD](#) [M85C](#) [M74C](#) [CSM4TH](#) [HMC8191-SX](#)
[CMD251C3](#) [MD-174-PIN](#) [CMD253C3](#) [HMC8192LG](#) [HMC553AG-SX](#) [HMC521A-SX](#) [HMC521ACHIPS](#) [HMC558A](#) [HMC553AG](#)
[HMC8191](#) [MAMX-011023-SMB](#) [EMRS-1TR](#) [ADL5355ACPZ-R7](#) [HMC399MS8TR](#) [HMC141LH5](#) [HMC333TR](#) [HMC214MS8TR](#)
[HMC175MS8TR](#) [HMC1043LC3TR](#) [F0552NLGI](#) [F1701NBGI](#) [F0502NLGI](#) [F1763NBGI](#) [MDS-189-PIN](#) [MAX2042AETP+](#) [MAX2032ETP+](#)
[MAX2043ETX+](#) [CSM2-13](#) [CSM4T](#) [HMC1056LP4BETR](#) [LTC5510IUF#PBF](#) [LTC5553IUDB#TRMPBF](#)