



SMT GaAs PHEMT MMIC LOW NOISE AMPLIFIER, 21 - 29 GHz

Typical Applications

The HMC341LC3B is ideal for:

- Point-to-Point Radios
- Point-to-Multi-Point Radios & VSAT
- Test Equipment & Sensors
- Military End-Use

Features

- 2.5 dB Noise Figure
- 13 dB Gain
- +3V @ 35 mA Supply
- 50 Ohm Matched Input/Output
- RoHS Compliant 3x3 mm SMT Package

Functional Diagram

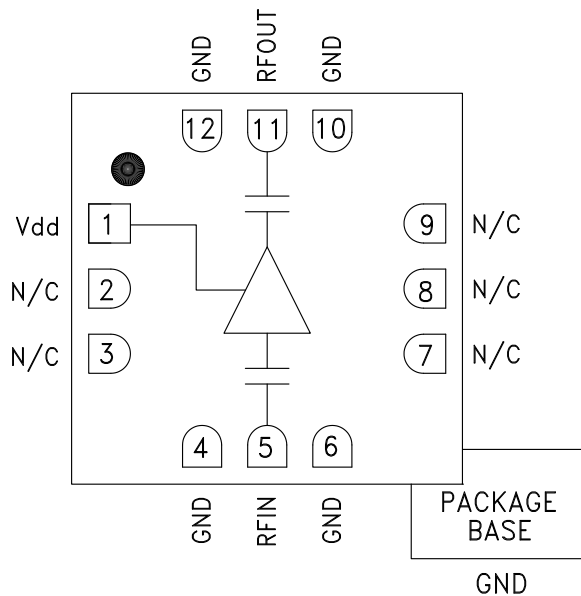

General Description

The HMC341LC3B is a GaAs pHEMT MMIC Low Noise Amplifier housed in a leadless RoHS compliant SMT package. Operating from 21 to 29 GHz, the amplifier provides 13 dB of gain and a noise figure of 2.5 dB from a single +3V supply. The RF I/Os are DC blocked and matched to 50 Ohms requiring no external components. The HMC341LC3B eliminates the need for wire bonding, allowing the use of surface mount manufacturing techniques.

Electrical Specifications, $T_A = +25^\circ C$, $V_{dd} = +3V$, $I_{dd} = 35 mA$

Parameter	Min.	Typ.	Max.	Min.	Typ.	Max.	Min.	Typ.	Max.	Units
Frequency Range	21 - 24			24 - 26			26 - 29			GHz
Gain	10.5	13.5		10	13		9	12		dB
Gain Variation Over Temperature		0.016	0.025		0.016	0.025		0.016	0.025	dB/ °C
Noise Figure		3.25	5		3	3.5		2.5	3	dB
Input Return Loss		10			11			9		dB
Output Return Loss		14			10			9		dB
Output Power for 1 dB Compression (P1dB)		8			8.5			8.5		dBm
Saturated Output Power (Psat)		11			11.5			11.5		dBm
Output Third Order Intercept (IP3)		19			19			19		dBm
Supply Current (Idd) (Vdd = +3V)		35			35			35		mA

Information furnished by Analog Devices is believed to be accurate and reliable. However, no responsibility is assumed by Analog Devices for its use, nor for any infringements of patents or other rights of third parties that may result from its use. Specifications subject to change without notice. No license is granted by implication or otherwise under any patent or patent rights of Analog Devices. Trademarks and registered trademarks are the property of their respective owners.

For price, delivery, and to place orders: Analog Devices, Inc., One Technology Way, P.O. Box 9106, Norwood, MA 02062-9106 Phone: 781-329-4700 • Order online at www.analog.com Application Support: Phone: 1-800-ANALOG-D



**SMT GaAs PHEMT MMIC
LOW NOISE AMPLIFIER, 21 - 29 GHz**

Broadband Gain & Return Loss

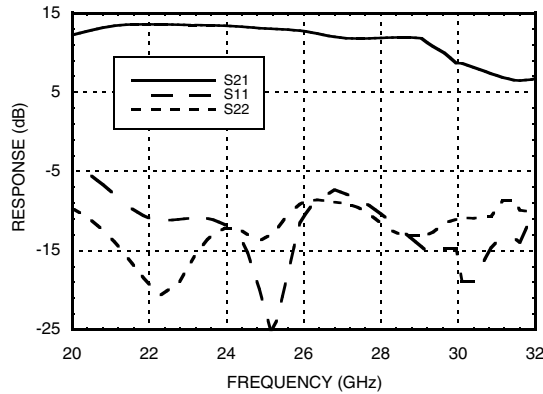

Gain vs. Temperature

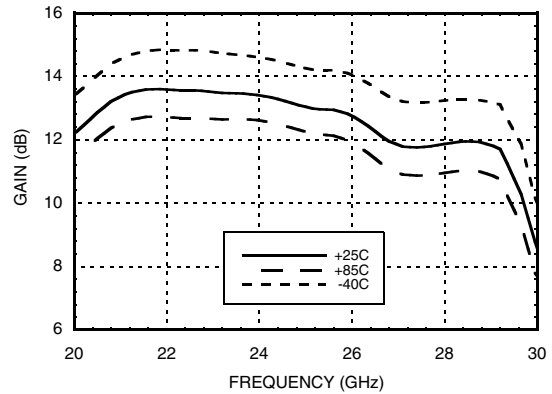

Input Return Loss vs. Temperature

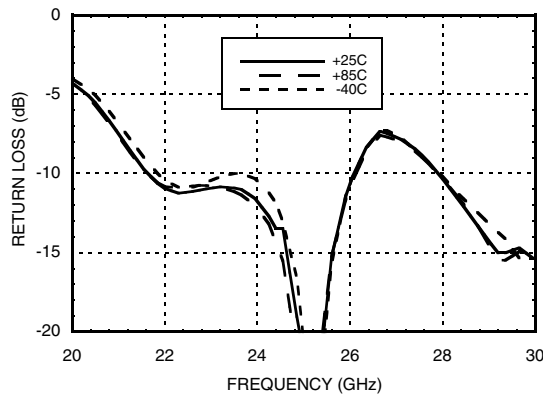

Output Return Loss vs. Temperature

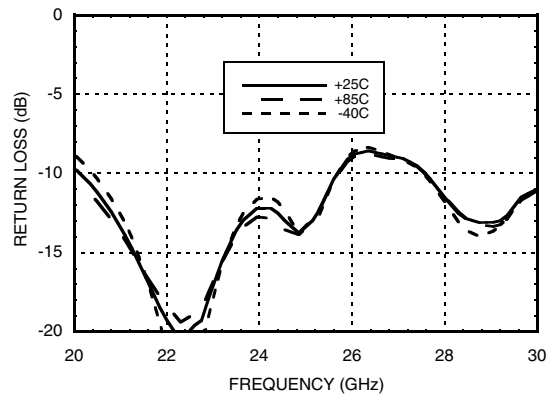

Noise Figure vs. Temperature

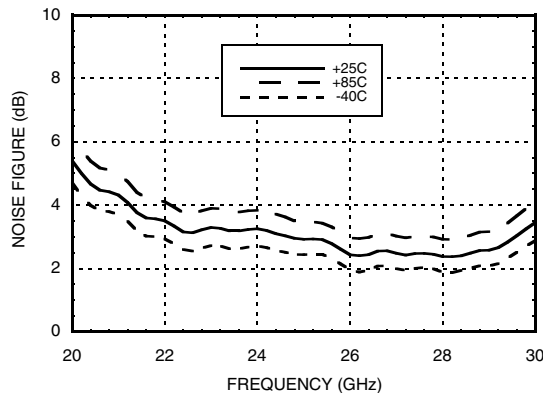

Output IP3 vs. Temperature

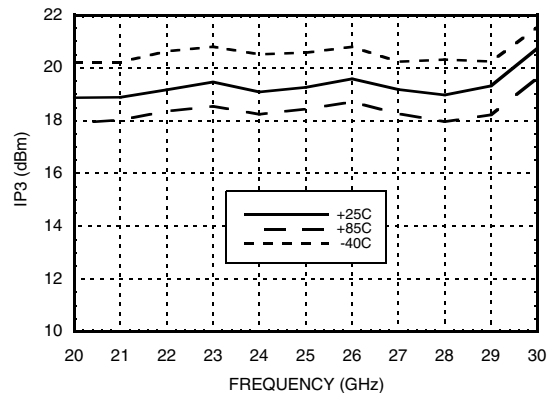



**SMT GaAs PHEMT MMIC
LOW NOISE AMPLIFIER, 21 - 29 GHz**

P1dB vs. Temperature

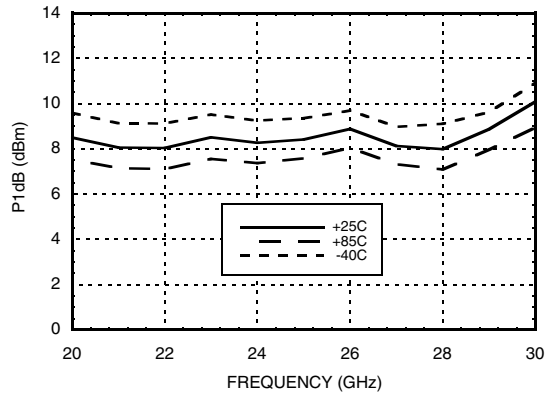

Psat vs. Temperature

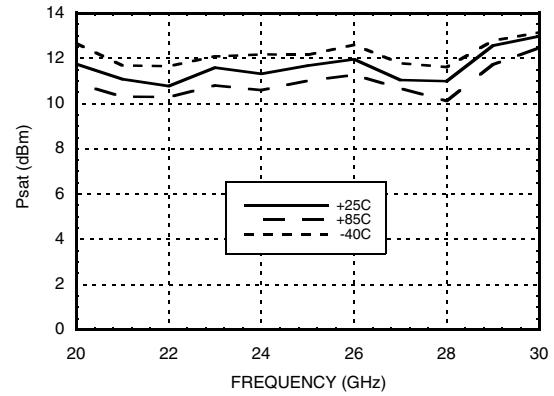

Power Compression @ 25 GHz

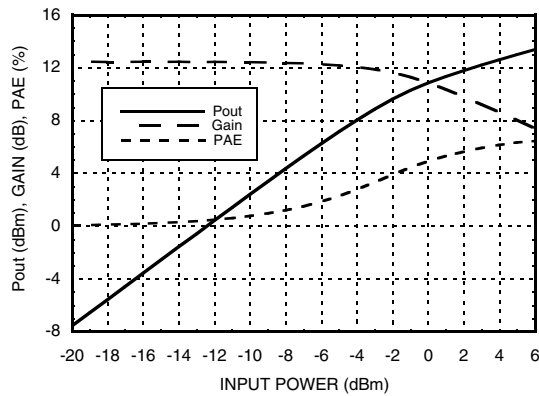

Reverse Isolation vs. Temperature

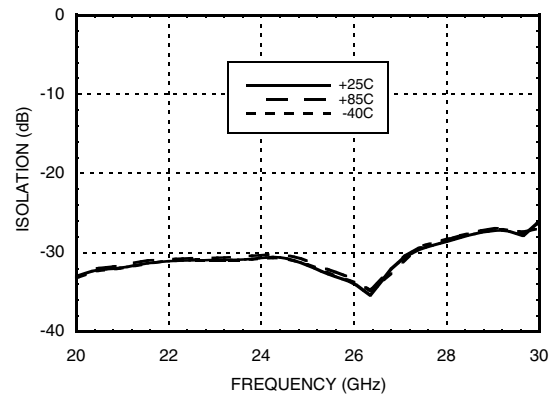

Gain, Power & Noise Figure vs. Supply Voltage @ 25 GHz

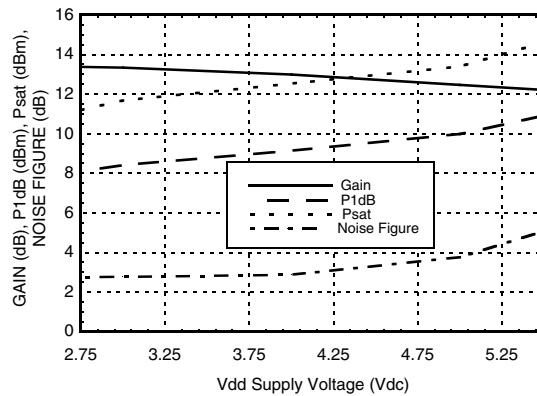

Information furnished by Analog Devices is believed to be accurate and reliable. However, no responsibility is assumed by Analog Devices for its use, nor for any infringements of patents or other rights of third parties that may result from its use. Specifications subject to change without notice. No license is granted by implication or otherwise under any patent or patent rights of Analog Devices. Trademarks and registered trademarks are the property of their respective owners.

For price, delivery, and to place orders: Analog Devices, Inc., One Technology Way, P.O. Box 9106, Norwood, MA 02062-9106 Phone: 781-329-4700 • Order online at www.analog.com Application Support: Phone: 1-800-ANALOG-D



SMT GaAs PHEMT MMIC LOW NOISE AMPLIFIER, 21 - 29 GHz

Absolute Maximum Ratings

Drain Bias Voltage (Vdd)	+5.5 Vdc
RF Input Power (RFIN)(Vdd = +3.0 Vdc)	+5 dBm
Channel Temperature	175 °C
Continuous P _{diss} (T= 85 °C) (derate 5.43 mW/°C above 85 °C)	0.489 W
Thermal Resistance (channel to ground paddle)	184 °C/W
Storage Temperature	-65 to +150 °C
Operating Temperature	-40 to +85 °C

Typical Supply Current vs. Vdd

Vdd (Vdc)	I _{dd} (mA)
+2.7	34
+3.0	35
+4.0	38
+5.0	41

Note: Amplifier will operate over full voltage ranges shown above.



ELECTROSTATIC SENSITIVE DEVICE
OBSERVE HANDLING PRECAUTIONS

Outline Drawing

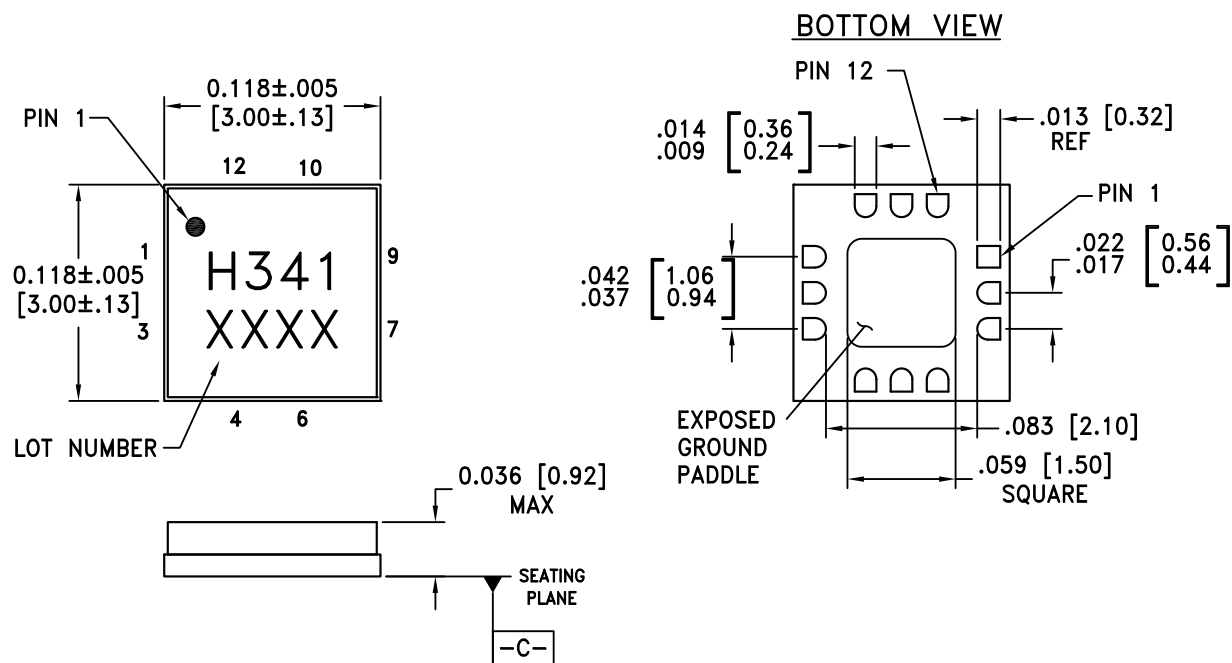

NOTES:

1. PACKAGE BODY MATERIAL: ALUMINA.
2. LEAD AND GROUND PADDLE PLATING: GOLD FLASH OVER NICKEL.
3. DIMENSIONS ARE IN INCHES (MILLIMETERS).
4. LEAD SPACING TOLERANCE IS NON-CUMULATIVE.
5. PACKAGE WARP SHALL NOT EXCEED 0.05MM DATUM .
6. ALL GROUND LEADS AND GROUND PADDLE MUST BE SOLDERED TO PCB RF GROUND.

Package Information

Part Number	Package Body Material	Lead Finish	MSL Rating	Package Marking ^[2]
HMC341LC3B	Alumina, White	Gold over Nickel	MSL3 ^[1]	H341 XXXX

[1] Max peak reflow temperature of 260 °C

[2] 4-Digit lot number XXXX



SMT GaAs PHEMT MMIC LOW NOISE AMPLIFIER, 21 - 29 GHz

Pin Descriptions

Pin Number	Function	Description	Interface Schematic
1	Vdd	Power Supply Voltage for the amplifier. External bypass capacitors of 100 pF, 1000pF, and 2.2 μF are required.	
2, 3, 7-9	N/C	No connection required. These pins may be connected to RF/DC ground without affecting performance.	
4, 6, 10, 12	GND	Package bottom has an exposed metal paddle that must also be connected to RF/DC ground.	
5	RFIN	This pin is AC coupled and matched to 50 Ohms from 21 - 29 GHz.	
11	RFOUT	This pin is AC coupled and matched to 50 Ohms from 21 - 29 GHz.	

Application Circuit

Component	Value
C1	100 pF
C2	1,000 pF
C3	2.2 μF

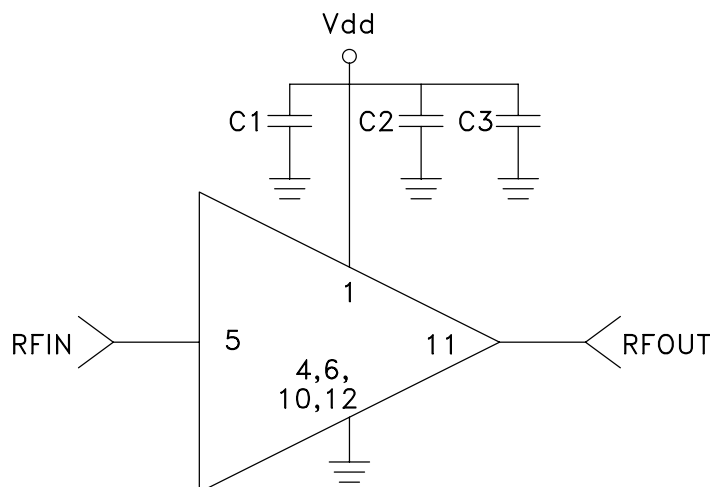



SMT GaAs PHEMT MMIC LOW NOISE AMPLIFIER, 21 - 29 GHz

Evaluation PCB

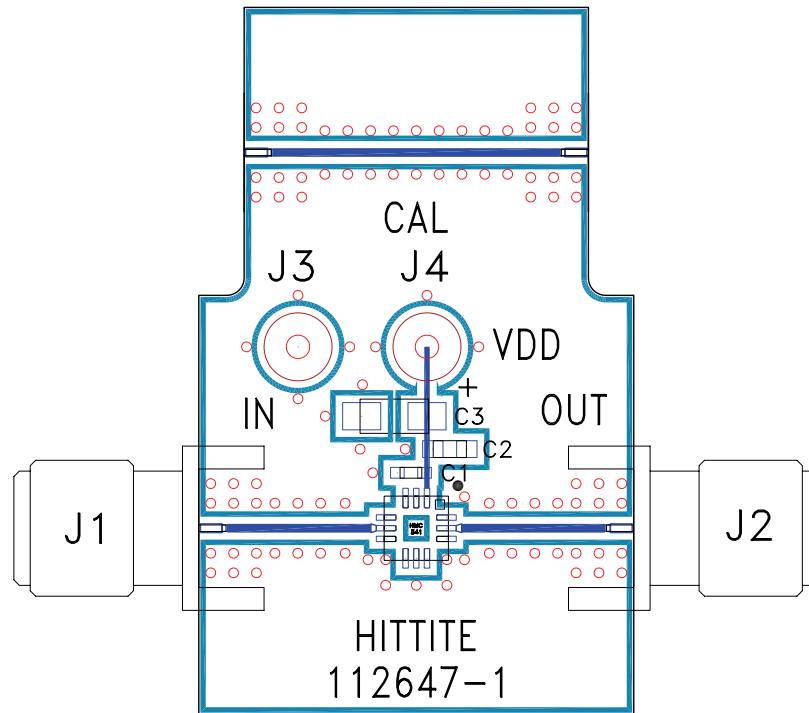

List of Materials for Evaluation PCB 112646 [1]

Item	Description
J1, J2	SRI K-connector
J3, J4	DC Pin
C1	100 pF capacitor, 0402 Pkg..
C2	1,000 pF Capacitor, 0603 Pkg..
C3	2.2µF Capacitor, Tantalum
U1	HMC341LC3B Amplifier
PCB [2]	112647 Evaluation PCB

[1] Reference this number when ordering complete evaluation PCB

[2] Circuit Board Material: Rogers 4350.

The circuit board used in this application should use RF circuit design techniques. Signal lines should have 50 Ohm impedance while the package ground leads and exposed paddle should be connected directly to the ground plane similar to that shown. A sufficient number of via holes should be used to connect the top and bottom ground planes. The evaluation board should be mounted to an appropriate heat sink. The evaluation circuit board shown is available from Hittite upon request.

X-ON Electronics

Largest Supplier of Electrical and Electronic Components

Click to view similar products for [RF Amplifier](#) category:

Click to view products by [Analog Devices](#) manufacturer:

Other Similar products are found below :

[A82-1](#) [BGA622H6820XTSA1](#) [BGA 728L7 E6327](#) [BGB719N7ESDE6327XTMA1](#) [HMC397-SX](#) [HMC405](#) [HMC561-SX](#) [HMC8120-SX](#)
[HMC8121-SX](#) [HMC-ALH382-SX](#) [HMC-ALH476-SX](#) [SE2433T-R](#) [SMA3101-TL-E](#) [SMA39](#) [A66-1](#) [A66-3](#) [A67-1](#) [A81-2](#) [LX5535LQ](#)
[LX5540LL](#) [MAAM02350](#) [HMC3653LP3BETR](#) [HMC549MS8GETR](#) [HMC-ALH435-SX](#) [SMA101](#) [SMA32](#) [SMA411](#) [SMA531](#)
[SST12LP19E-QX6E](#) [WPM0510A](#) [HMC5929LS6TR](#) [HMC5879LS7TR](#) [HMC1087F10](#) [HMC1086](#) [HMC1016](#) [SMA1212](#) [MAX2689EWS+T](#)
[MAAMSS0041TR](#) [MAAM37000-A1G](#) [LTC6430AIUF-15#PBF](#) [SMA70-2](#) [SMA4011](#) [A231](#) [HMC-AUH232](#) [LX5511LQ](#) [LX5511LQ-TR](#)
[HMC7441-SX](#) [HMC-ALH310](#) [XD1001-BD-000V](#) [A4011](#)