

GaAs MMIC VOLTAGE-VARIABLE ATTENUATOR, DC - 14 GHz

Typical Applications

The HMC346ALP3E is ideal for:

- Basestation Infrastructure
- Fiber Optics & Broadband Telecom
- Microwave Radio & VSAT
- Military Radios, Radar, & ECM
- Test Instrumentation

Features

- Wide Bandwidth: DC - 14 GHz
- Low Phase Shift vs. Attenuation
- 30 dB Attenuation Range
- Simplified Voltage Control
- 3 x 3 x 1 mm SMT Package

Functional Diagram

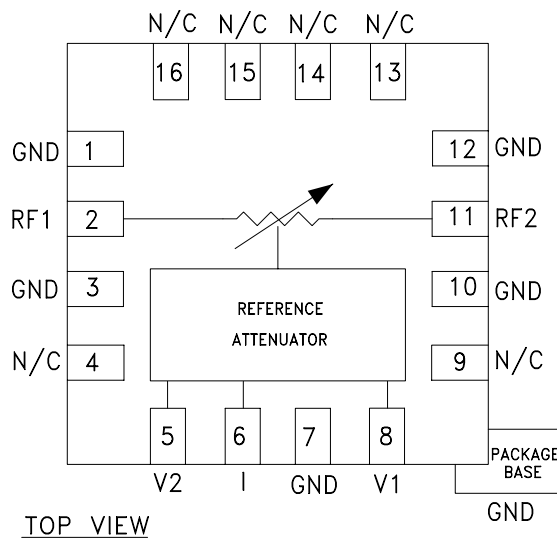

General Description

The HMC346ALP3E is an absorptive Voltage Variable Attenuator (VVA) in low cost leadless surface mount plastic package operating from DC - 14 GHz. It features an on-chip reference attenuator for use with an external op-amp to provide simple single voltage attenuation control, 0 to -5V. The device is ideal in designs where an analog DC control signal must control RF signal levels over a 30 dB amplitude range.

Electrical Specifications, $T_A = +25^\circ\text{C}$, 50 Ohm system

Parameter	Min	Typical	Max	Units
Insertion Loss	DC - 10GHz	2.6	3.1	dB
	DC - 14 GHz	2.7	3.2	dB
Attenuation Range	DC - 10 GHz	27	30	dB
	DC - 14 GHz	23	28	dB
Return Loss	DC - 14 GHz	5	10	dB
Switching Characteristics	tRISE, tFALL (10/90% RF):	8		ns
	tON, tOFF (50% CTL to 10/90% RF):	16		ns
Input Power for 0.25 dB Compression (0.5 -14GHz)	Min. Atten:	+10		dBm
	Atten. >2 dB:	+5		dBm
Input Third Order Intercept (0.5 - 14 GHz) (Two-tone Input Power = -8 dBm Each Tone)	Min. Atten:	+30		dBm
	Atten. >2 dB:	+10		dBm

GaAs MMIC VOLTAGE-VARIABLE ATTENUATOR, DC - 14 GHz

Insertion Loss vs. Temperature

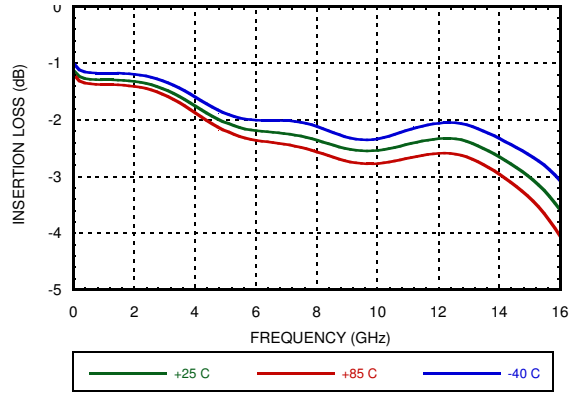

Relative Attenuation

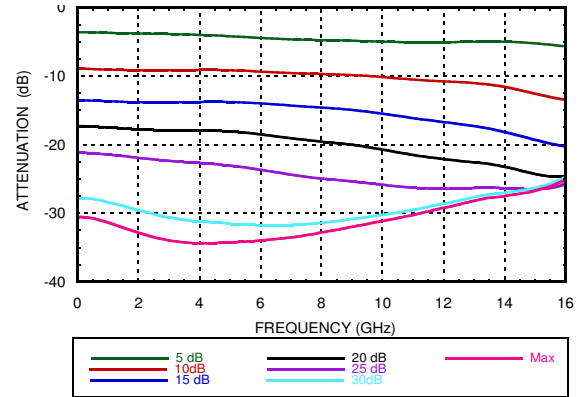

Return Loss vs. Attenuation

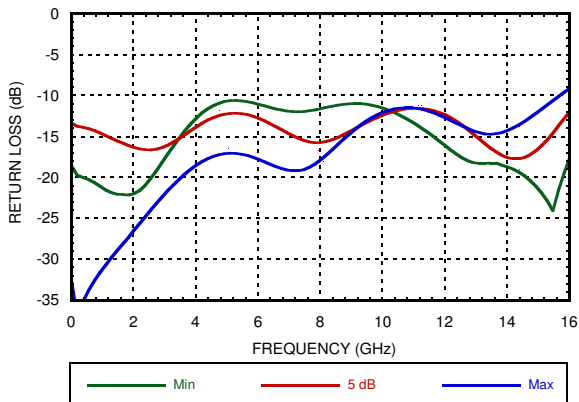

Relative Attenuation vs. Control Voltage @ 10 GHz

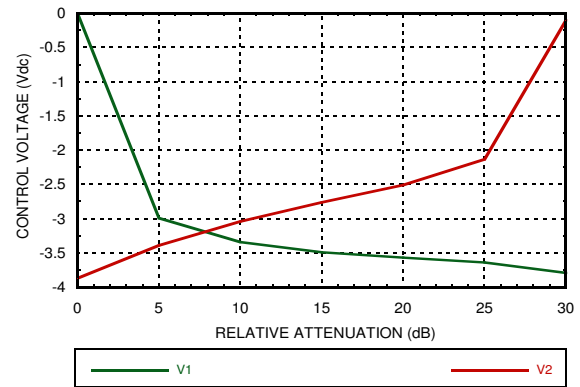

Relative Phase

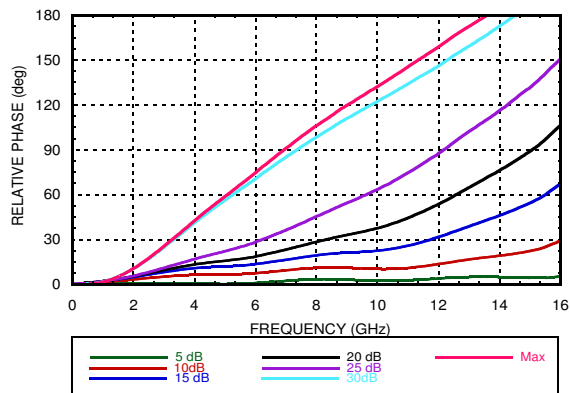

Input IP3 vs. Attenuation*

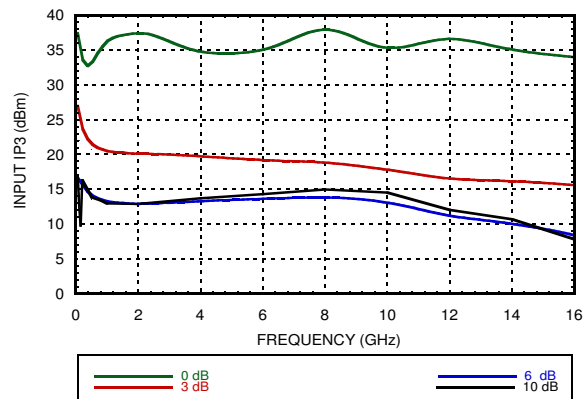

*Two-tone input power = -8 dBm each tone, 1 MHz spacing.

**GaAs MMIC VOLTAGE-VARIABLE
ATTENUATOR, DC - 14 GHz**

Input IP2 vs. Attenuation*

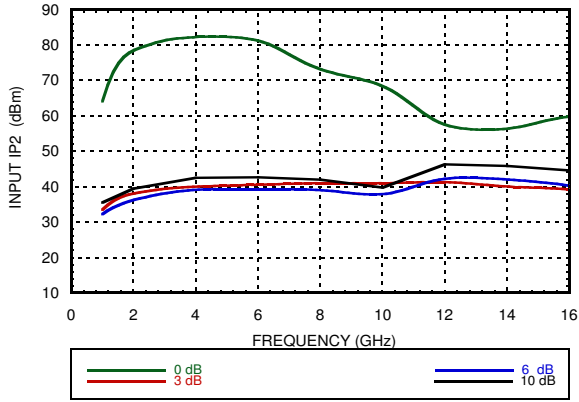

Second Harmonic vs. Attenuation, Pin = -8 dBm

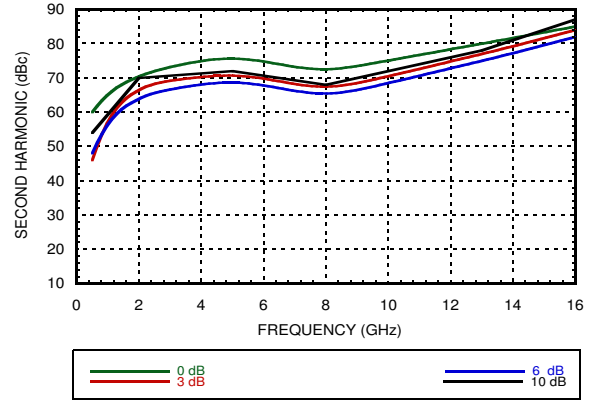

0.25 dB Compression vs. Attenuation

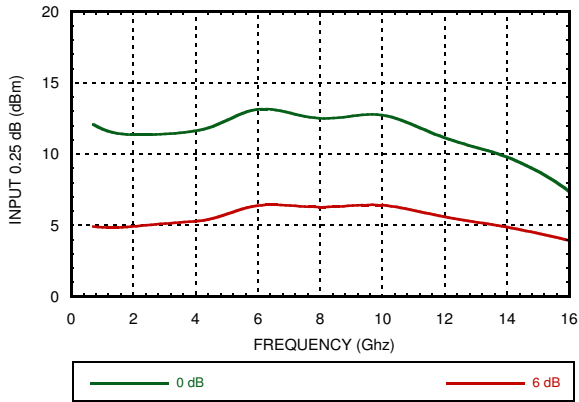

1 dB Compression vs. Attenuation

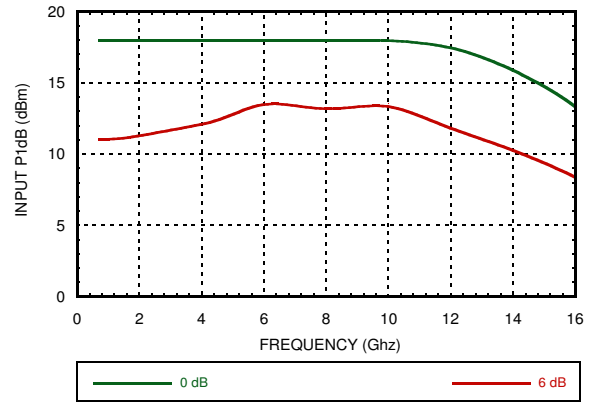

*Two-tone input power = -8 dBm each tone, 1 MHz spacing.

GaAs MMIC VOLTAGE-VARIABLE ATTENUATOR, DC - 14 GHz

Absolute Maximum Ratings

RF Input Power	+18 dBm
DC Voltage on I Pin	+/- 0.8V
Control Voltage Range	+0.3 to -6V
Storage Temperature	-65 to +150 °C
Operating Temperature	-40 to +85 °C
Junction Temperature	+175 °C
Junction to Case Thermal Resistance	10 °C/W
ESD Sensitivity	Class 1A

State	Bias Condition
V1	-5 to 0V @ 9 mA typical.
V2	-5 to 0V @ 9 mA typical.



ELECTROSTATIC SENSITIVE DEVICE
OBSERVE HANDLING PRECAUTIONS

Outline Drawing

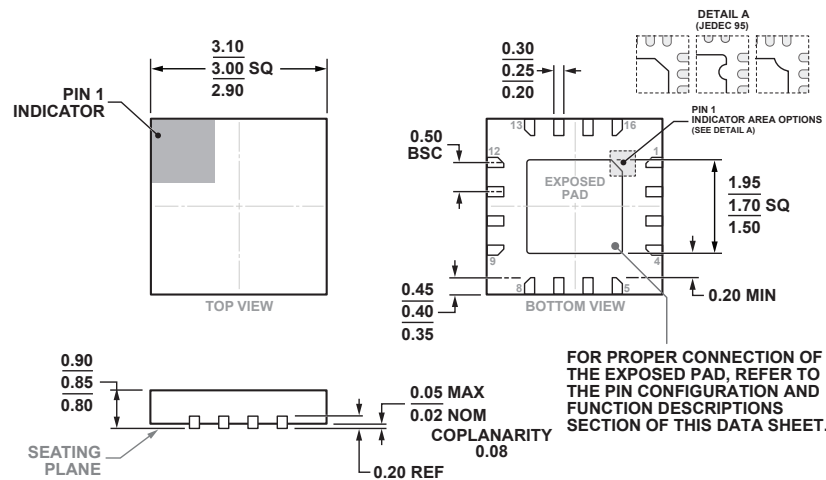

COMPLIANT WITH JEDEC STANDARDS MO-220-VEED-4.

16-Lead Lead Frame Chip Scale Package [LFCSP]
3 mm x 3 mm Body and 0.85 mm Package Height
(HCP-16-1)

Dimensions shown in millimeters

Package Information

Part Number	Package Body Material	Lead Finish	MSL Rating	Package Marking ^[2]
HMC346ALP3E	RoHS-compliant Low Stress Injection Molded Plastic	100% matte Sn	MSL3 ^[1]	H346A XXXX

[[1] Max peak reflow temperature of 260 °C

[2] 4-Digit lot number XXXX

GaAs MMIC VOLTAGE-VARIABLE ATTENUATOR, DC - 14 GHz

Pin Descriptions

Pin Number	Function	Description	Interface Schematic
1, 3, 7, 10, 12	GND	Package bottom has exposed metal paddle that must also be connected to PCB RF ground.	
2, 11	RF1 RF2	This pin is DC coupled and matched to 50 Ohm. Blocking capacitors are required if the RF line potential is not equal to 0V.	
4, 9, 13, 14, 15, 16	N/C	This pin should be connected to PCB RF ground.	
5, 8	V2, V1	Control input (master).	
6	I	Control input (slave).	

Single-Line Control Driver

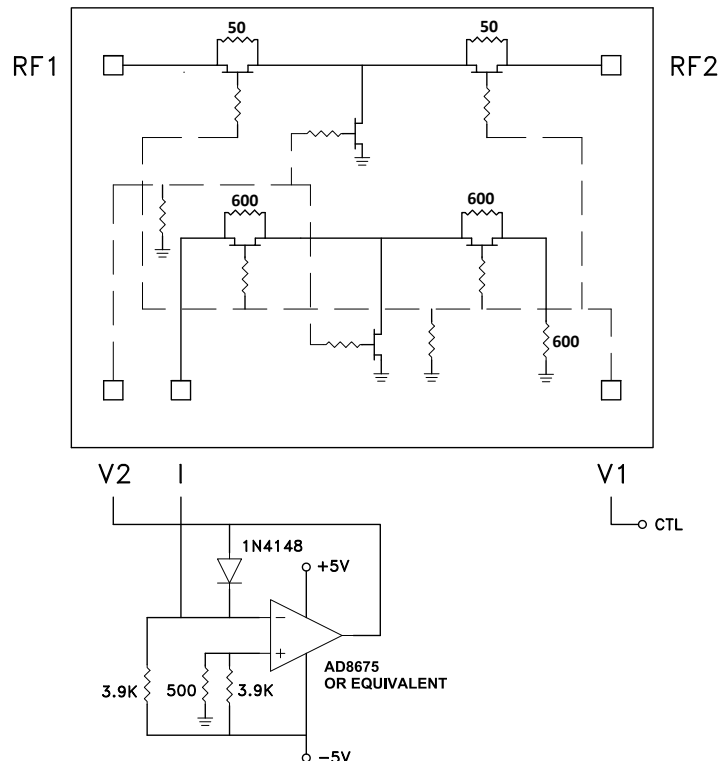

External op-amp control circuit maintains impedance match while attenuation is varied. Input control ranges from 0 Volts (min. attenuation) to -5.0 Volts (max. attenuation.)

**GaAs MMIC VOLTAGE-VARIABLE
ATTENUATOR, DC - 14 GHz**

Evaluation PCB

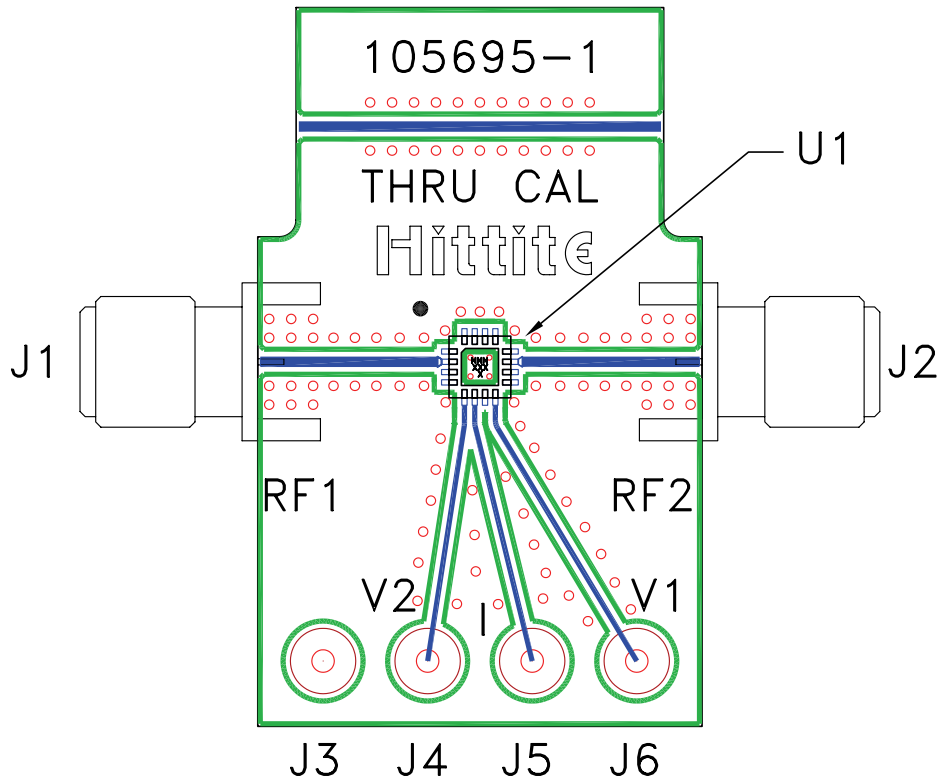

List of Materials for Evaluation EV1HMC346ALP3 [1]

Item	Description
J1 - J2	PCB Mount SMA RF Connector
J3 - J6	DC Pin
U1	HMC346ALP3E VVA
PCB [2]	105695 Evaluation PCB

[1] Reference this number when ordering complete evaluation PCB

[2] Circuit Board Material: Rogers 4350

The circuit board used in the application should be generated with proper RF circuit design techniques. Signal lines at the RF ports should be 50 Ohm impedance and the package ground leads and package bottom should be connected directly to the PCB RF ground plane, similar to that shown above. The evaluation circuit board shown above is available from Analog Devices Inc. upon request.

X-ON Electronics

Largest Supplier of Electrical and Electronic Components

Click to view similar products for [Attenuators](#) category:

Click to view products by [Analog Devices](#) manufacturer:

Other Similar products are found below :

[ATN3580-01](#) [HMC305SLP4ETR](#) [MAAD-009195-000100](#) [TGL4201-00](#) [TGL4201-02](#) [TGL4201-03](#) [TGL4201-06](#) [TGL4201-10](#) [ATN3590-15](#) [20-50TPC](#) [D10AA5Z4](#) [18AH-01](#) [18AH-08](#) [ATN3580-20](#) [ATN3590-09](#) [20-50RP](#) [MASW-008322-000000](#) [MAATCC0009TR](#) [PCAF-10](#) [EXB-24AT9AR5X](#) [ATN3580-10](#) [HMC539ALP3ETR](#) [ATN3580-02](#) [WA04P006XCTL](#) [SKY12408-321LF](#) [ATN3580-03](#) [WA04P005XBTL](#) [HMC-VVD104-SX](#) [WA04P007XCTL](#) [SKY12236-11](#) [MAATSS0018TR-3000](#) [HMC656-SX](#) [WA04P001XBTL](#) [MAAV-007941-TR3000](#) [WA04P004XBTL](#) [WA04P002XBTL](#) [HMC941A](#) [PAT0816-C-0DB-T5](#) [PAT0816-C-8DB-T5](#) [PAT0816-C-10DB-T5](#) [PAT1632-C-3DB-T1](#) [PAT1632-C-6DB-T1](#) [PAT1632-C-10DB-T1](#) [PAT1632-C-1DB-T1](#) [PAT0816-C-2DB-T5](#) [PAT0816-C-4DB-T5](#) [DHM510-0100-006](#) [MAT10300](#) [MAT10180](#) [MAATCC0007-TB](#)