

Typical Applications

Prescaler for DC to Ku Band PLL Applications:

- Satellite Communication Systems
- Fiber Optic
- Point-to-Point and Point-to-Multi-Point Radios
- VSAT

Features

- Ultra Low SSB Phase Noise: -151 dBc/Hz
- Wide Bandwidth
- Output Power: 5 dBm
- Single DC Supply: +5V
- Small Size: 1.30 x 0.69 x 0.1 mm

Functional Diagram

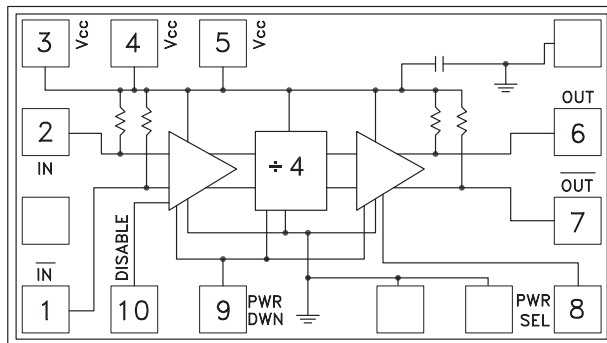

General Description

The HMC365 is a low noise Divide-by-4 Static Divider with InGaP GaAs HBT technology that has a small size of 1.30 x 0.69 mm. This device operates from DC (with a square wave input) to 13 GHz input frequency with a single +5V DC supply. The low additive SSB phase noise of -151 dBc/Hz at 100 kHz offset helps the user maintain good system noise performance.

Electrical Specifications, $T_A = +25^\circ \text{C}$, 50 Ohm System, $V_{CC} = 5V$

| Parameter | Conditions | Min. | Typ. | Max. | Units |
|----------------------------------|---------------------------------------|------|------|------|--------|
| Maximum Input Frequency | | 13 | 14 | | GHz |
| Minimum Input Frequency | Sine Wave Input. [1] | | 0.2 | 0.5 | GHz |
| Input Power Range | $F_{in} = 1$ to 10 GHz | -15 | >-20 | +10 | dBm |
| | $F_{in} = 10$ to 12 GHz | -10 | >-15 | +3 | dBm |
| | $F_{in} = 12$ to 13 GHz | -5 | >-8 | +3 | dBm |
| Output Power [2] | $F_{in} = 13$ GHz | 2 | 5 | | dBm |
| Reverse Leakage | Both RF Outputs Terminated | | 45 | | dB |
| SSB Phase Noise (100 kHz offset) | $P_{in} = 0$ dBm, $F_{in} = 6$ GHz | | -151 | | dBc/Hz |
| Output Transition Time | $P_{in} = 0$ dBm, $F_{out} = 882$ MHz | | 100 | | ps |
| Supply Current (I_{CC}) [2] | | | 110 | | mA |

[1] Divider will operate down to DC for square-wave input signal.

[2] When operated in high power mode (pin 8 connected to ground).

**GaAs HBT MMIC
DIVIDE-BY-4, DC - 13 GHz**

Input Sensitivity Window, $T = 25\text{ }^{\circ}\text{C}$

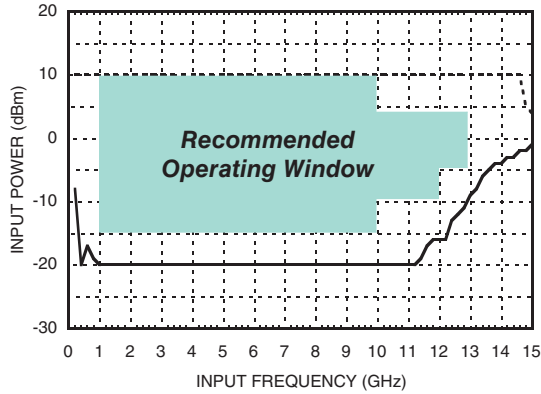

Input Sensitivity Window vs. Temperature

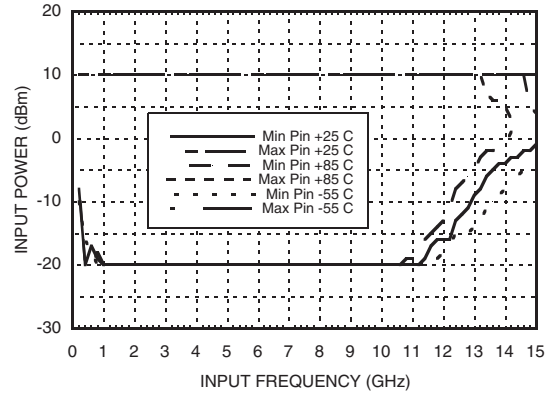

Output Power vs. Temperature

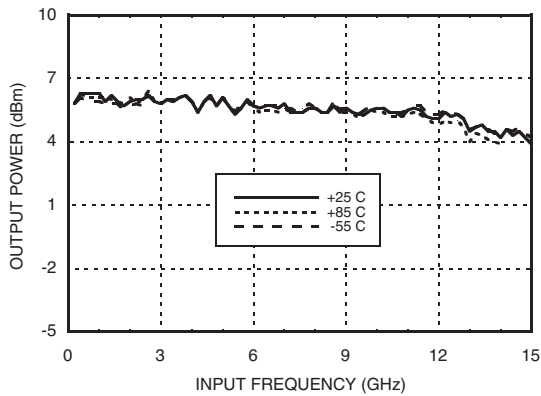

SSB Phase Noise Performance, $P_{in} = 0\text{ dBm}$, $T = 25\text{ }^{\circ}\text{C}$

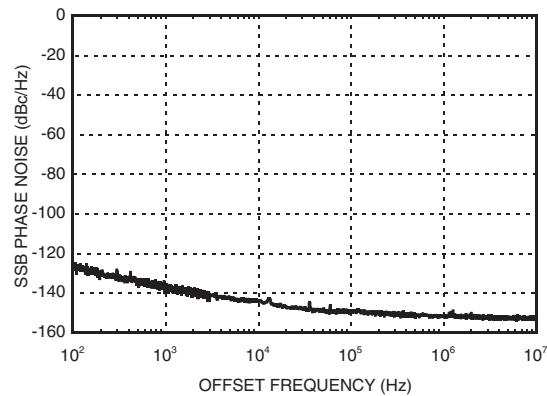

Output Harmonic Content, $P_{in} = 0\text{ dBm}$, $T = 25\text{ }^{\circ}\text{C}$

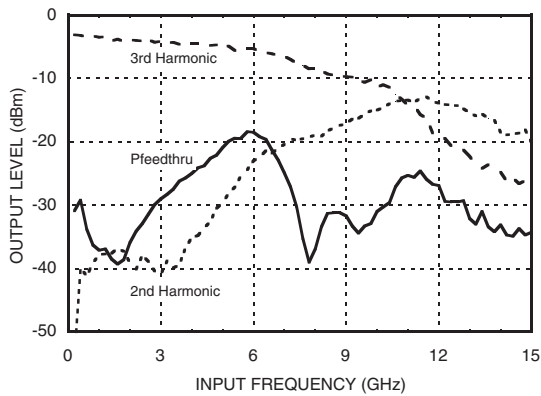

Reverse Leakage, $P_{in} = 0\text{ dBm}$, $T = 25\text{ }^{\circ}\text{C}$

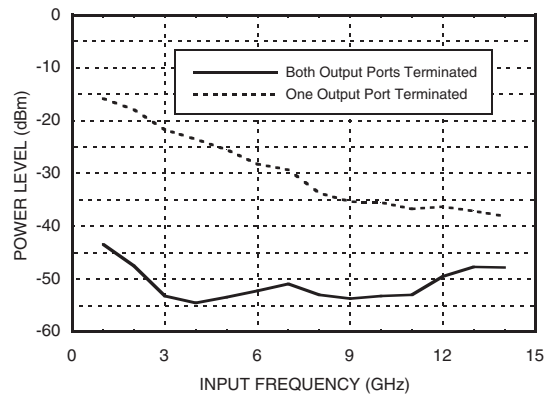

Information furnished by Analog Devices is believed to be accurate and reliable. However, no responsibility is assumed by Analog Devices for its use, nor for any infringements of patents or other rights of third parties that may result from its use. Specifications subject to change without notice. No license is granted by implication or otherwise under any patent or patent rights of Analog Devices. Trademarks and registered trademarks are the property of their respective owners.

For price, delivery, and to place orders: Analog Devices, Inc., One Technology Way, P.O. Box 9106, Norwood, MA 02062-9106 Phone: 781-329-4700 • Order online at www.analog.com Application Support: Phone: 1-800-ANALOG-D

**GaAs HBT MMIC
DIVIDE-BY-4, DC - 13 GHz**

**Output Voltage Waveform,
Pin= 0 dBm, Fout= 882 MHz, T= 25 °C**

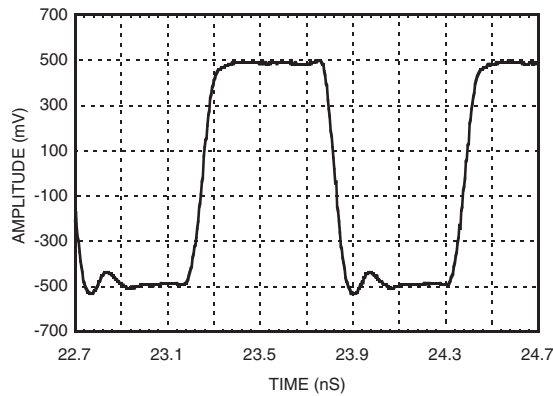

Absolute Maximum Ratings

| | |
|-----------------------|------------------------|
| RF Input (Vcc = +5V) | +13 dBm |
| Vcc | +5.5V |
| VLogic | Vcc -1.6V to Vcc -1.2V |
| Storage Temperature | -65 to +150 °C |
| Operating Temperature | -55 to +85 °C |



**ELECTROSTATIC SENSITIVE DEVICE
OBSERVE HANDLING PRECAUTIONS**

Typical Supply Current vs. Vcc

| Vcc (V) | Icc (mA) |
|---------|----------|
| 4.75 | 94 |
| 5.0 | 110 |
| 5.25 | 118 |

Note: Divider will operate over full voltage range shown above

Outline Drawing

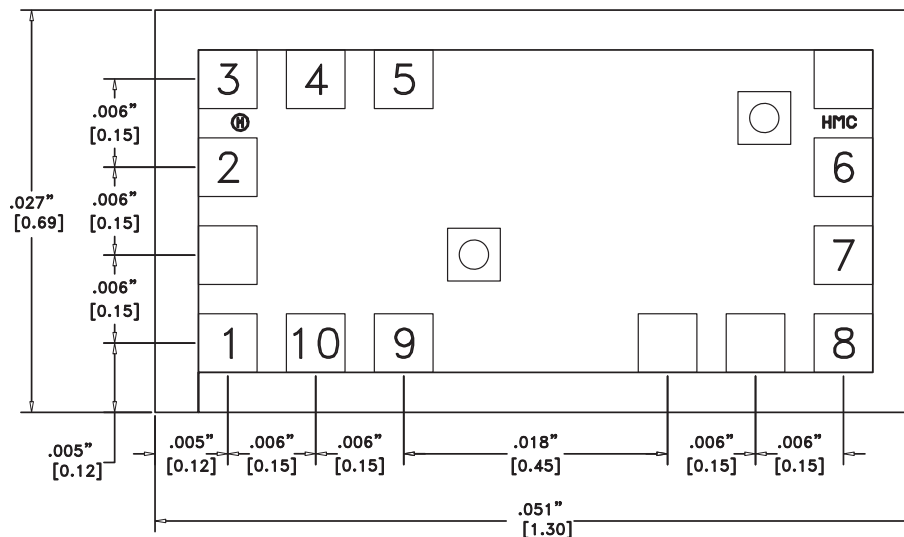

Die Packaging Information [1]

| Standard | Alternate |
|--------------------|-----------|
| WP-8 (Waffle Pack) | [2] |

[1] Refer to the "Packaging Information" section for die packaging dimensions.

[2] For alternate packaging information contact Hittite Microwave Corporation.

NOTES:

- ALL DIMENSIONS IN INCHES (MILLIMETERS)
- ALL TOLERANCES ARE ±0.001 (0.025)
- DIE THICKNESS IS 0.004 (0.100) BACKSIDE IS GROUND
- BOND PADS ARE 0.004 (0.100) SQUARE
- BOND PAD SPACING, CTR-CTR: 0.006 (0.150)
- BACKSIDE METALLIZATION: GOLD
- BOND PAD METALLIZATION: GOLD

Information furnished by Analog Devices is believed to be accurate and reliable. However, no responsibility is assumed by Analog Devices for its use, nor for any infringements of patents or other rights of third parties that may result from its use. Specifications subject to change without notice. No license is granted by implication or otherwise under any patent or patent rights of Analog Devices. Trademarks and registered trademarks are the property of their respective owners.

For price, delivery, and to place orders: Analog Devices, Inc., One Technology Way, P.O. Box 9106, Norwood, MA 02062-9106
Phone: 781-329-4700 • Order online at www.analog.com
Application Support: Phone: 1-800-ANALOG-D

GaAs HBT MMIC DIVIDE-BY-4, DC - 13 GHz

Pad Description

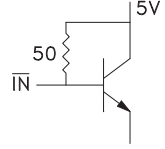
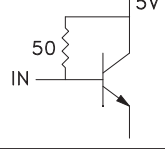
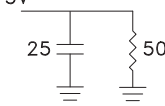
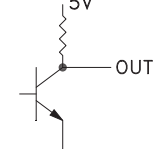
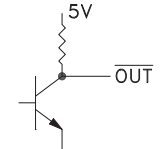
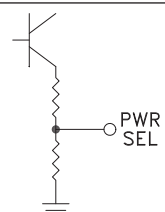
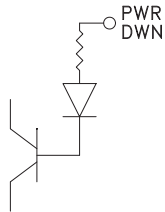
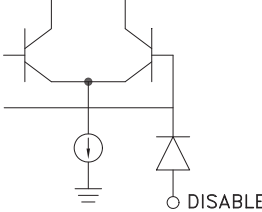
| Pad Number | Function | Description | Interface Schematic |
|------------|------------------|---|---|
| 1 | \overline{IN} | RF Input 180° out of phase with pad 3 for differential operation. AC ground for single ended operation. |  |
| 2 | IN | RF Input must be DC blocked. |  |
| 3, 4, 5 | Vcc | Supply Voltage 5V ±0.25V can be applied to pad 3, 4, or 5. |  |
| 6 | OUT | Divided Output |  |
| 7 | \overline{OUT} | Divided output 180° out of phase with OUT. |  |
| 8 | PWR SEL | In the low power mode, the power select pin is left floating. By grounding this pin, the output power is increased by approximately 10 dB. |  |
| 9 | PWR DWN | The power down pin is grounded for normal operation. Applying 5 volts to this pin will power down this device. |  |
| 10 | DISABLE | The disable pin is grounded for normal operation. Applying 5 volts to this pin will disable the input buffer amplifier. |  |

**GaAs HBT MMIC
DIVIDE-BY-4, DC - 13 GHz**

Truth Table

| Function | Pin | 5V | GND | Float |
|----------|-----|------------|-------------------|------------------|
| DISABLE | 10 | Output Off | Output On | X |
| PWR DWN | 9 | Power Down | Power Up | X |
| PWR SEL | 8 | X | High Power Output | Low Power Output |

X = State not permitted.

Assembly Diagrams

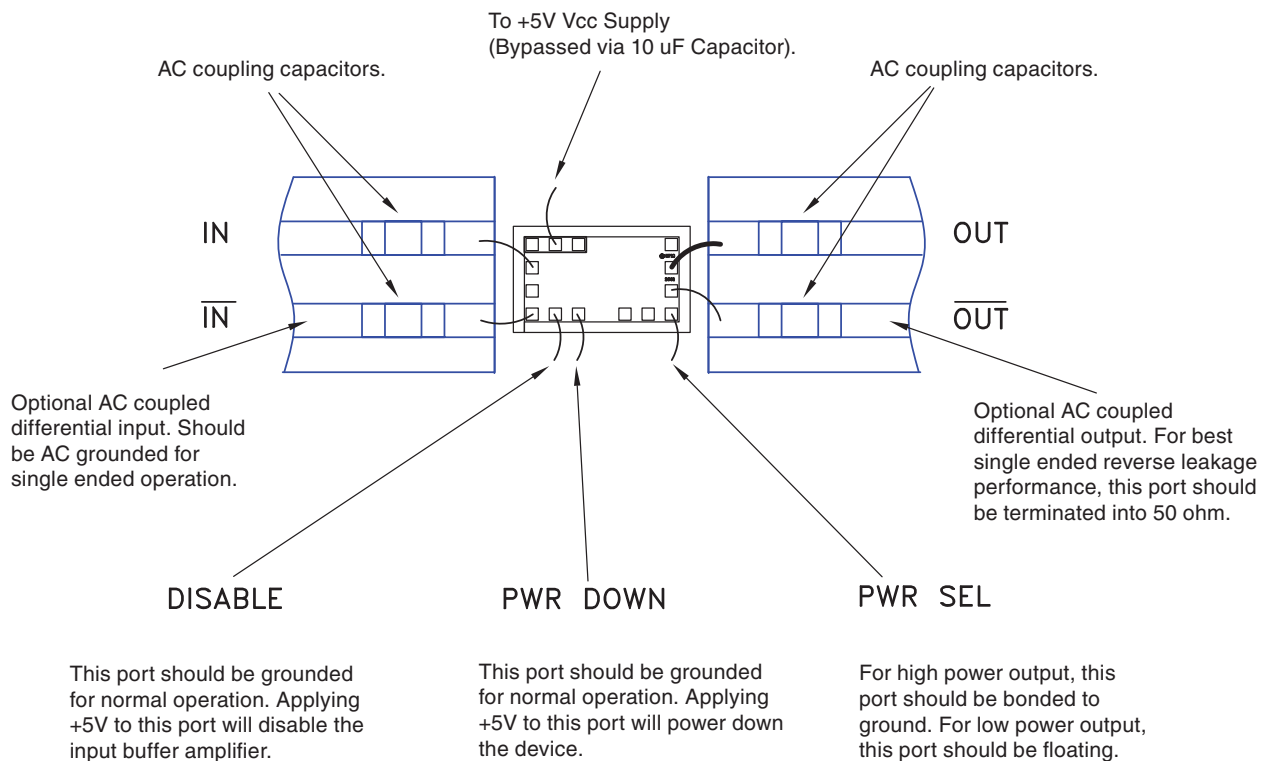

Information furnished by Analog Devices is believed to be accurate and reliable. However, no responsibility is assumed by Analog Devices for its use, nor for any infringements of patents or other rights of third parties that may result from its use. Specifications subject to change without notice. No license is granted by implication or otherwise under any patent or patent rights of Analog Devices. Trademarks and registered trademarks are the property of their respective owners.

For price, delivery, and to place orders: Analog Devices, Inc., One Technology Way, P.O. Box 9106, Norwood, MA 02062-9106 Phone: 781-329-4700 • Order online at www.analog.com Application Support: Phone: 1-800-ANALOG-D

**GaAs HBT MMIC
DIVIDE-BY-4, DC - 13 GHz****Handling Precautions**

Follow these precautions to avoid permanent damage.

Cleanliness: Handle the chips in a clean environment. DO NOT attempt to clean the chip using liquid cleaning systems.

Static Sensitivity: Follow ESD precautions to protect against ESD strikes.

Transients: Suppress instrument and bias supply transients while bias is applied. Use shielded signal and bias cables to minimize inductive pick-up.

General Handling: Handle the chip along the edges with a vacuum collet or with a sharp pair of bent tweezers. The surface of the chip has fragile air bridges and should not be touched with vacuum collet, tweezers, or fingers.

Mounting

The chip is back-metallized and can be die mounted with electrically conductive epoxy. The mounting surface should be clean and flat.

Epoxy Die Attach: Apply a minimum amount of epoxy to the mounting surface so that a thin epoxy fillet is observed around the perimeter of the chip once it is placed into position. Cure epoxy per the manufacturer's schedule.

Wire Bonding

Ball or wedge bond with 0.025 mm (1 mil) diameter pure gold wire. Thermosonic wirebonding with a nominal stage temperature of 150 °C and a ball bonding force of 40 to 50 grams or wedge bonding force of 18 to 22 grams is recommended. Use the minimum level of ultrasonic energy to achieve reliable wirebonds. Wirebonds should be started on the chip and terminated on the package or substrate. All bonds should be as short as possible <0.31 mm (12 mils).

X-ON Electronics

Largest Supplier of Electrical and Electronic Components

Click to view similar products for [Prescaler](#) category:

Click to view products by [Analog Devices](#) manufacturer:

Other Similar products are found below :

[UXD20P](#) [UXN14M9P](#) [MX1DS10P](#) [UXN14M32K](#) [HMC492LP3TR](#) [HMC434TR](#) [HMC433TR](#) [HMC394LP4TR](#) [MC12093MNR4G](#)
[NB7N017MMNG](#) [HMC437MS8GTR](#) [HMC434SRJZ-EP-PT](#) [HMC365S8G](#) [HMC362S8G](#) [ADF5000BCPZ](#) [ADF5001BCPZ](#) [ADF5002BCPZ](#)
[HMC988LP3ETR](#) [HMC361G8](#) [HMC361S8G](#) [HMC361S8GETR](#) [HMC363G8](#) [HMC363S8G](#) [HMC363S8GETR](#) [HMC365G8](#)
[HMC365S8GETR](#) [HMC394LP4ETR](#) [HMC437MS8G](#) [HMC447LC3](#) [HMC447LC3TR](#) [HMC492LP3ETR](#) [HMC492LP3](#) [HMC493LP3E](#)
[HMC433](#) [HMC432ETR](#) [HMC434ETR](#) [HMC434E](#) [HMC432](#) [HMC432E](#) [HMC794LP3E](#) [HMC859LC3](#) [HMC983LP5E](#) [HMC438MS8GTR](#)
[ADMV2101BRHZ](#) [UXM15P](#) [HMC437MS8GETR](#) [HMC438MS8G](#) [HMC438MS8GE](#) [HMC438MS8GETR](#) [MC12026ADG](#)