

### FEATURES

- Downconverter, 8.5 GHz to 13.5 GHz
- Conversion loss: 9 dB typical
- Image rejection: 27.5 dBc typical
- LO to RF isolation: 39 dB typical
- Input IP3: 16 dBm typical
- Wide IF bandwidth: dc to 3.5 GHz
- 3.9 mm × 3.9 mm, 24-terminal LCC package: 16 mm<sup>2</sup>

### APPLICATIONS

- Microwave and very small aperture terminal (VSAT) radios
- Test equipment
- Military electronic warfare (EW); electronic countermeasure (ECM); and command, control, communications, and intelligence (C3I)

### GENERAL DESCRIPTION

The HMC521ALC4 is a compact, gallium arsenide (GaAs), monolithic microwave integrated circuit (MMIC), inphase quadrature (I/Q) mixer in a RoHS compliant, 24-terminal ceramic leadless chip carrier (LCC) package. This device can be used as either an image reject mixer or a single sideband upconverter. The mixer uses two standard, double balanced

### FUNCTIONAL BLOCK DIAGRAM

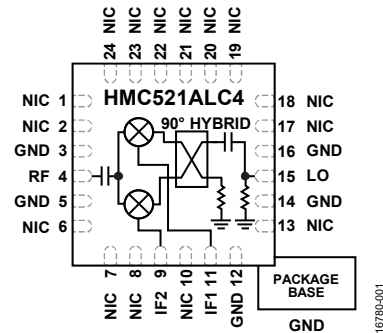

Figure 1.

mixer cells and a 90° hybrid coupler fabricated in a GaAs, metal semiconductor field effect transistor (MESFET) process. This device is a smaller alternative to hybrid style image reject mixers and single sideband upconverter assemblies. The HMC521ALC4 eliminates the need for wire bonding, allowing use of surface-mount manufacturing techniques.

**TABLE OF CONTENTS**

Features .....	1	Downconverter Performance, IF = 100 MHz.....	6
Applications.....	1	Downconverter Performance, IF = 3500 MHz .....	10
Functional Block Diagram .....	1	Upconverter Performance, IF = 100 MHz.....	12
General Description .....	1	Upconverter Performance, IF = 3500 MHz.....	14
Revision History .....	2	IF Bandwidth Downconverter.....	18
Specifications.....	3	Spurious and Harmonics Performance .....	20
Absolute Maximum Ratings.....	4	Theory of Operation .....	21
Thermal Resistance .....	4	Applications Information .....	22
ESD Caution.....	4	Typical Application Circuit.....	22
Pin Configuration and Function Descriptions.....	5	Evaluation PCB Information .....	23
Interface Schematics.....	5	Outline Dimensions .....	24
Typical Performance Characteristics .....	6	Ordering Guide .....	24

**REVISION HISTORY**

**10/2019—Rev. 0 to Rev. A**

Changes to Figure 1 and General Description Section .....	1
Changes to Table 2.....	4
Changes to Figure 2 and Table 4.....	5
Changes to Figure 27 Caption.....	9
Changes to Figure 31 Caption, Figure 32 Caption, and Figure 33 Caption .....	10

Changes to Figure 74 Caption and Figure 75 Caption .....	17
Changes to Table 6 and Table 7 .....	20
Changes to Figure 86.....	22

**7/2018—Revision 0: Initial Version**

## SPECIFICATIONS

T<sub>A</sub> = 25°C, IF = 100 MHz, local oscillator (LO) = 15 dBm, upper sideband. All measurements performed as a downconverter, unless otherwise noted, on the evaluation printed circuit board (PCB).

Table 1.

Parameter	Symbol	Test Conditions/Comments	Min	Typ	Max	Unit
<b>FREQUENCY RANGE</b>						
Radio Frequency (RF) Pin			8.5		13.5	GHz
IFx Pin			DC		3.5	GHz
LO Pin			8.5		13.5	GHz
<b>LO AMPLITUDE</b>						
				15		dBm
<b>8.5 GHz TO 13.5 GHz PERFORMANCE</b>						
Downconverter		Taken as image reject mixer				
Conversion Loss				9	9.5	dB
Noise Figure	NF	Taken with LO amplifier		14		dB
Image Rejection			17	27.5		dBc
Input Third-Order Intercept	IP3			16		dBm
Input 1 dB Compression Point	P1dB			7.5		dBm
Upconverter		Taken as a single sideband upconverter mixer				
Conversion Loss				9		dB
Input Third-Order Intercept	IP3			15.5		dBm
Input 1 dB Compression Point	P1dB			8.3		dBm
Isolation		Taken without external 90° hybrid				
RF to IF				32.5		dB
LO to RF				39		dB
LO to IF				18.5		dB
Balance		Taken without external 90° hybrid				
Amplitude Balance				0.1		dB
Phase Balance				6.5		Degrees
<b>10.5 GHz TO 11.7 GHz PERFORMANCE</b>						
Downconverter						
Conversion Loss				7.8	8	dB
Noise Figure		Taken with LO amplifier		10		dB
Image Rejection			22	27		dBc
Input Third-Order Intercept	IP3			16		dBm
Input 1 dB Compression Point	P1dB			7.5		dBm
Upconverter		Taken as a single sideband upconverter mixer				
Conversion Loss				7		dB
Input Third-Order Intercept	IP3			17		dBm
Input 1 dB Compression Point	P1dB			8.8		dBm
Isolation		Taken without external 90° hybrid				
RF to IF				38		dB
LO to RF				37		dB
LO to IF				14		dB
Balance		Taken without external 90° hybrid				
Amplitude Balance				0.1		dB
Phase Balance				3.6		Degrees

## ABSOLUTE MAXIMUM RATINGS

Table 2.

Parameter	Rating
RF Input Power	20 dBm
LO Input Power	27 dBm
IFx Input Power	20 dBm
IFx Source and Sink Current	2 mA
Peak Reflow Temperature (Moisture Sensitivity Level 3 (MSL3)) <sup>1</sup>	260°C
Junction Temperature (T <sub>J</sub> )	175°C
Lifetime at Maximum (T <sub>J</sub> )	>1 × 10 <sup>6</sup> hours
Continuous Power Dissipation, P <sub>DISS</sub> (T <sub>A</sub> = 85°C, Derate 6.22 mW/°C Above 85°C)	608 mW
Operating Temperature Range	–40°C to +85°C
Storage Temperature Range	–65°C to +150°C
Lead Temperature Range	–65°C to +150°C
Electrostatic Discharge (ESD) Sensitivity	
Human Body Model (HBM)	250 V
Field Induced Charged Device Model (FICDM)	500 V

<sup>1</sup> See the Ordering Guide.

Stresses at or above those listed under Absolute Maximum Ratings may cause permanent damage to the product. This is a stress rating only; functional operation of the product at these or any other conditions above those indicated in the operational section of this specification is not implied. Operation beyond the maximum operating conditions for extended periods may affect product reliability.

### THERMAL RESISTANCE

Thermal performance is directly linked to PCB design and operating environment. Careful attention to PCB thermal design is required.

$\theta_{JA}$  is the natural convection junction to ambient thermal resistance measured in a one cubic foot sealed enclosure.  $\theta_{JC}$  is the junction to case thermal resistance.

Table 3. Thermal Resistance

Package Type	$\theta_{JA}$	$\theta_{JC}$	Unit
E-24-1 <sup>1</sup>	120	148	°C/W

<sup>1</sup> Test Condition 1: JEDEC Standard JESD51-2.

### ESD CAUTION



**ESD (electrostatic discharge) sensitive device.** Charged devices and circuit boards can discharge without detection. Although this product features patented or proprietary protection circuitry, damage may occur on devices subjected to high energy ESD. Therefore, proper ESD precautions should be taken to avoid performance degradation or loss of functionality.

# PIN CONFIGURATION AND FUNCTION DESCRIPTIONS

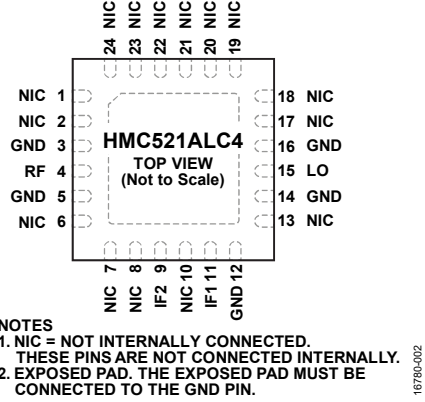

Figure 2. Pin Configuration

Table 4. Pin Function Descriptions

Pin No.	Mnemonic	Description
1, 2, 6 to 8, 10, 13, 17 to 24	NIC	Not Internally Connected. These pins are not connected internally.
3, 5, 12, 14, 16	GND	Ground. These pins and package bottom must be connected to RF and dc ground. See Figure 3 for the GND interface schematic.
4	RF	Radio Frequency Port. This pin is ac-coupled and matched to 50 Ω. See Figure 6 for the RF interface schematic.
9	IF2	Second Quadrature Intermediate Frequency Port. This pin is dc-coupled. For applications not requiring operation to dc, dc block this port externally using a series capacitor of a value chosen to pass the necessary IF frequency range. For operation to dc, these pins must not source or sink more than 2 mA of current. Otherwise, die malfunction or die failure may result. See Figure 5 for the IFx interface schematic.
11	IF1	First Quadrature Intermediate Frequency Port. This pin is dc-coupled. For applications not requiring operation to dc, dc block this port externally using a series capacitor of a value chosen to pass the necessary IF frequency range. For operation to dc, these pins must not source or sink more than 2 mA of current. Otherwise, die malfunction or die failure may result. See Figure 5 for the IFx interface schematic.
15	LO EPAD	Local Oscillator Port. This pin is ac-coupled and matched to 50 Ω. See Figure 4 for the LO interface schematic. Exposed Pad. The exposed pad must be connected to the GND pin.

## INTERFACE SCHEMATICS



Figure 3. GND Interface Schematic

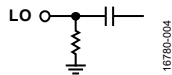

Figure 4. LO Interface Schematic

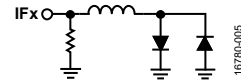

Figure 5. IFx Interface Schematic

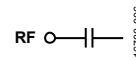

Figure 6. RF Interface Schematic

# TYPICAL PERFORMANCE CHARACTERISTICS

## DOWNCONVERTER PERFORMANCE, IF = 100 MHz

### Upper Sideband (Low-Side LO)

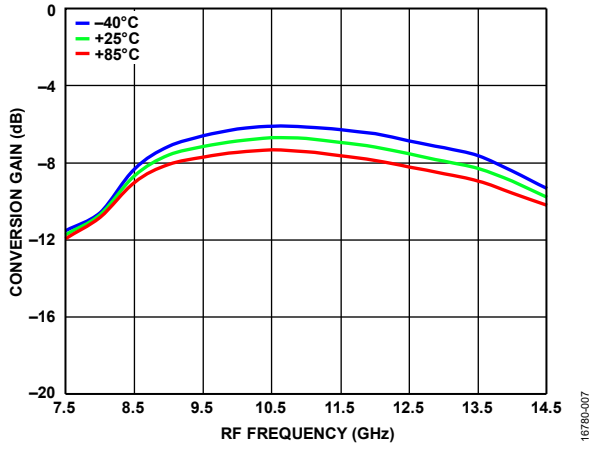

Figure 7. Conversion Gain vs. RF Frequency at Various Temperatures, LO = 15 dBm

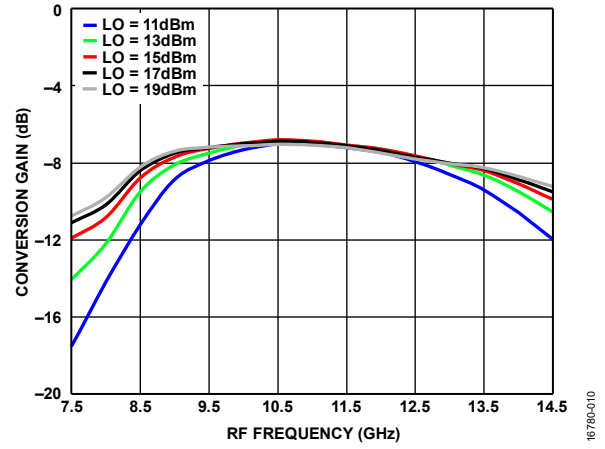

Figure 10. Conversion Gain vs. RF Frequency at Various LO Power Levels,  $T_A = 25^\circ\text{C}$

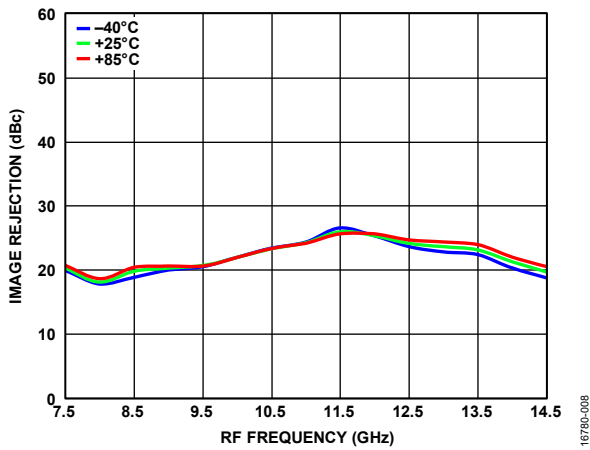

Figure 8. Image Rejection vs. RF Frequency at Various Temperatures, LO = 15 dBm

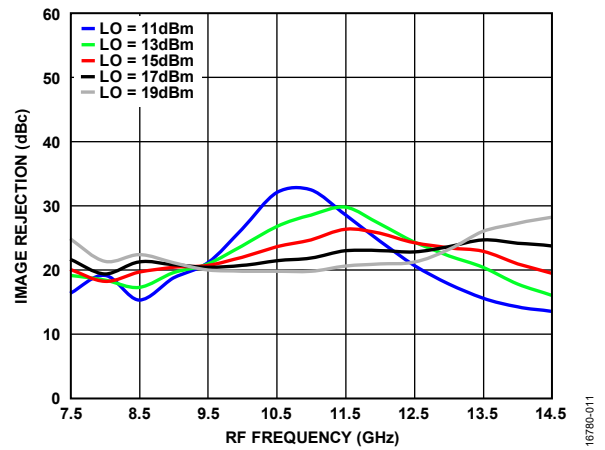

Figure 11. Image Rejection vs. RF Frequency at Various LO Power Levels,  $T_A = 25^\circ\text{C}$

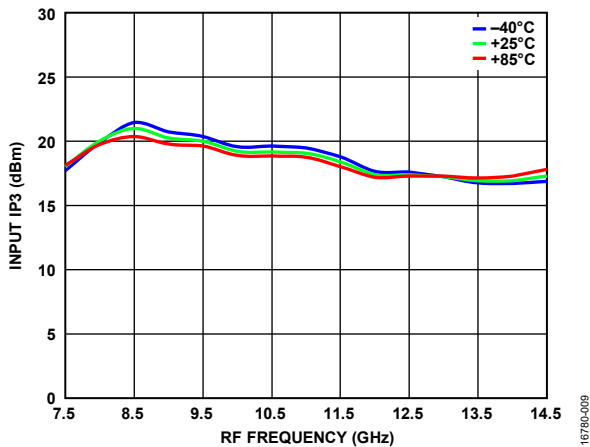

Figure 9. Input IP3 vs. RF Frequency at Various Temperatures, LO = 15 dBm

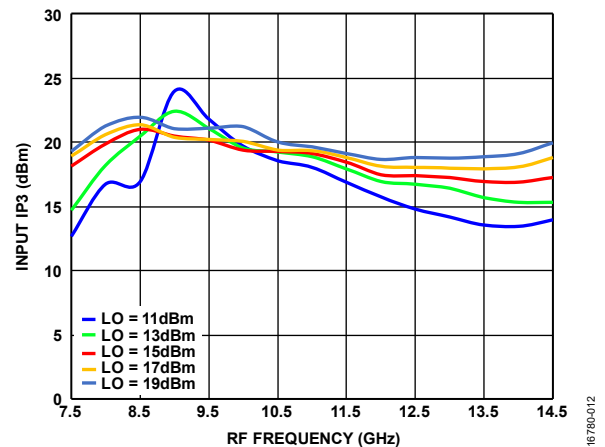

Figure 12. Input IP3 vs. RF Frequency at Various LO Power Levels,  $T_A = 25^\circ\text{C}$

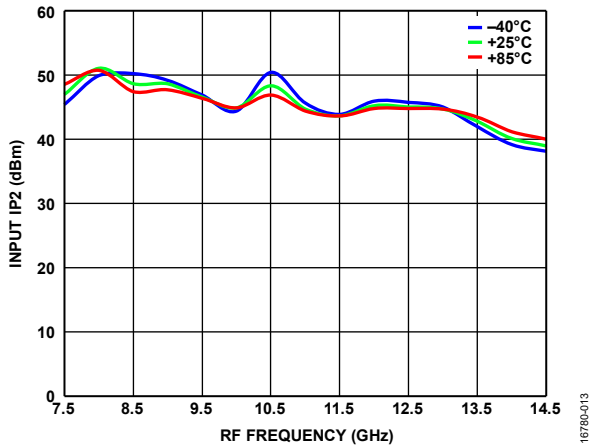

Figure 13. Input IP2 vs. RF Frequency at Various Temperatures, LO = 15 dBm

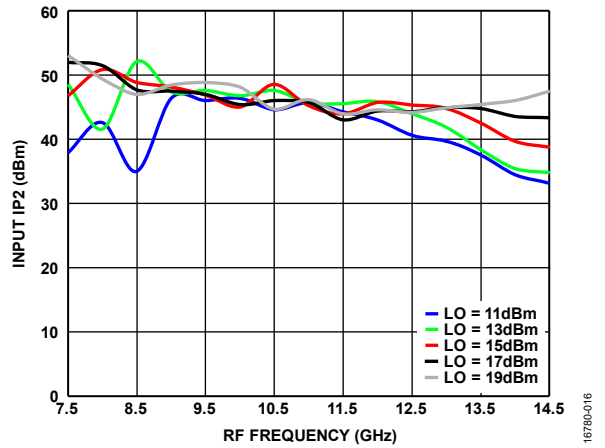

Figure 16. Input IP2 vs. RF Frequency at Various LO Power Levels, TA = 25°C

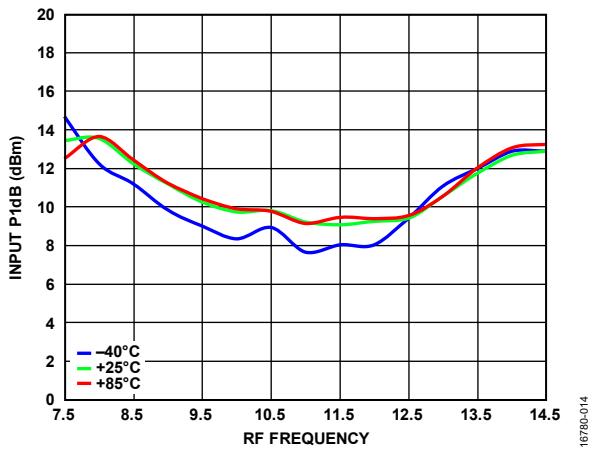

Figure 14. Input P1dB vs. RF Frequency at Various Temperatures, LO = 15 dBm

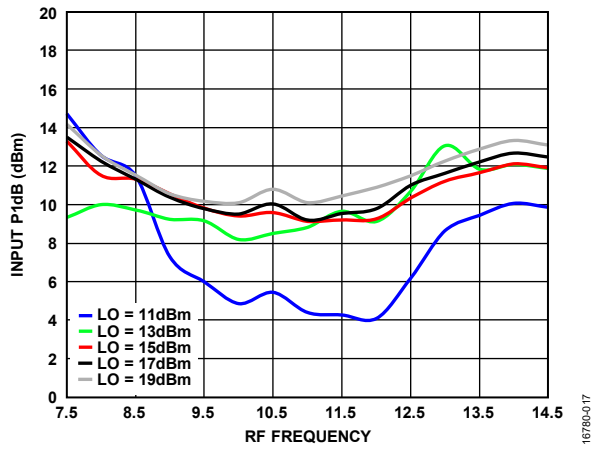

Figure 17. Input P1dB vs. RF Frequency at Various LO Power Levels, TA = 25°C

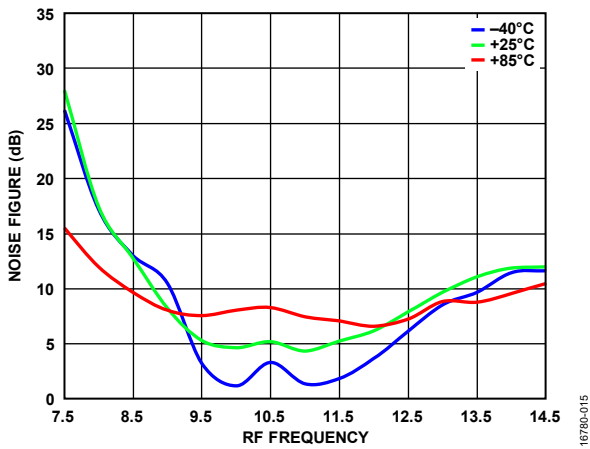

Figure 15. Noise Figure vs. RF Frequency at Various Temperatures, LO = 15 dBm

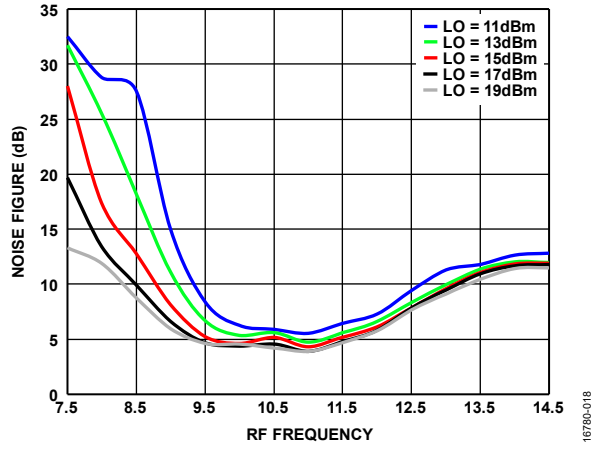

Figure 18. Noise Figure vs. RF Frequency at Various LO Power Levels, TA = 25°C

Lower Sideband (High-Side LO)

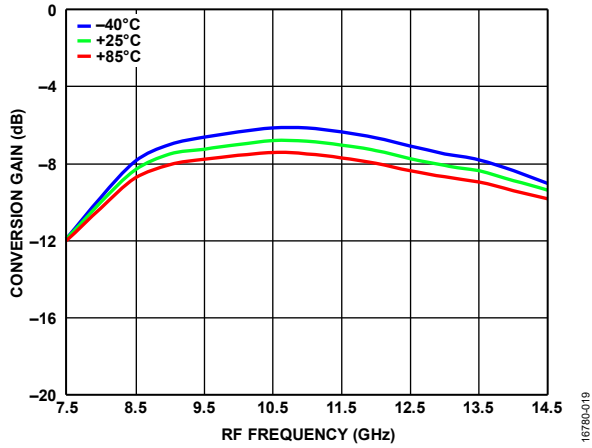

Figure 19. Conversion Gain vs. RF Frequency at Various Temperatures, LO = 15 dBm

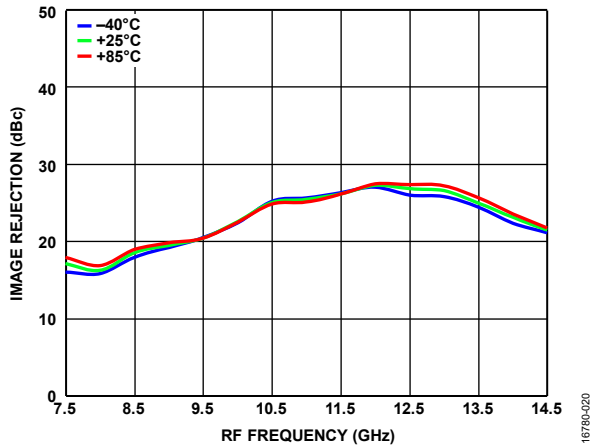

Figure 20. Image Rejection vs. RF Frequency at Various Temperatures, LO = 15 dBm

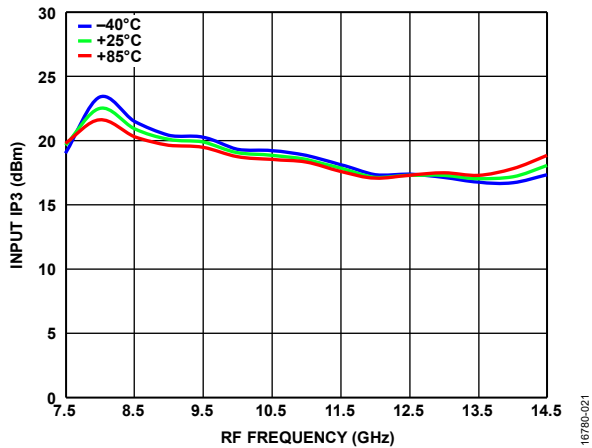

Figure 21. Input IP3 vs. RF Frequency at Various Temperatures, LO = 15 dBm

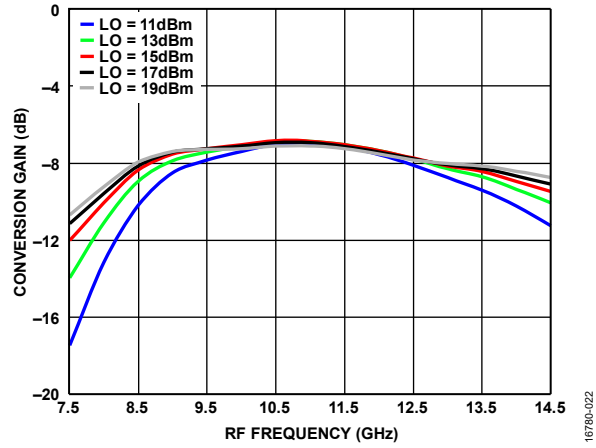

Figure 22. Conversion Gain vs. RF Frequency at Various LO Power Levels, TA = 25°C

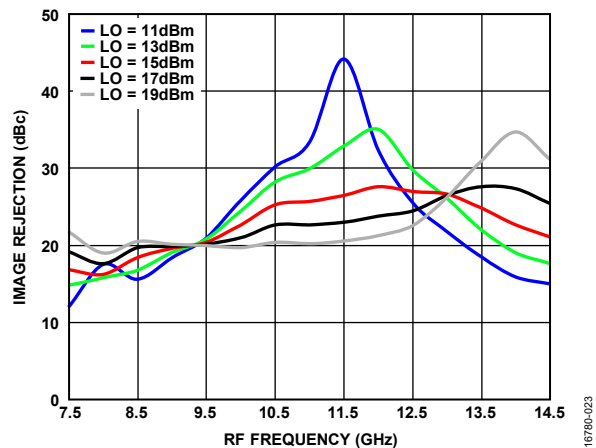

Figure 23. Image Rejection vs. RF Frequency at Various LO Power Levels, TA = 25°C

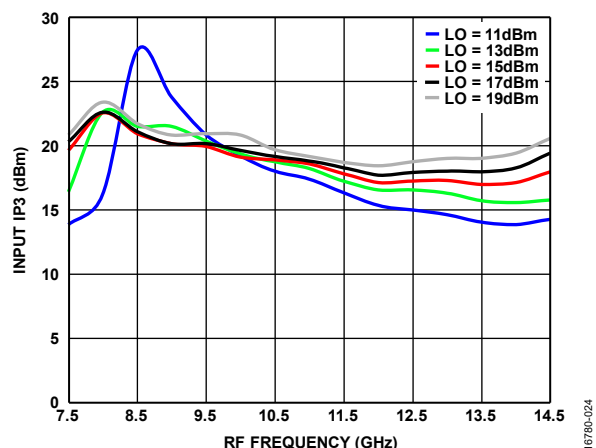

Figure 24. Input IP3 vs. RF Frequency at Various LO Power Levels, TA = 25°C



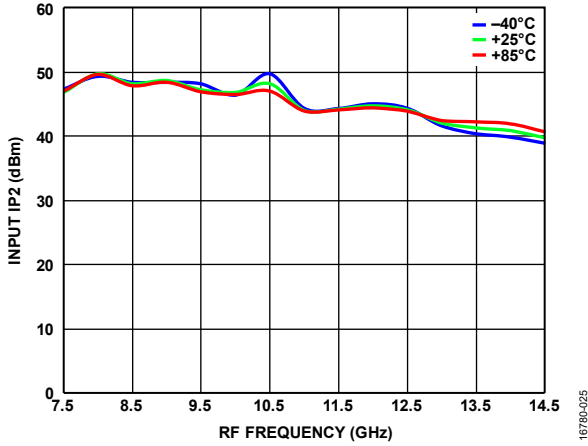

Figure 25. Input IP2 vs. RF Frequency at Various Temperatures, LO = 15 dBm

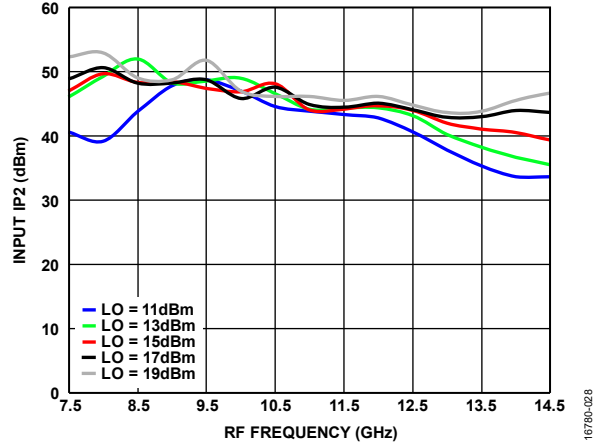

Figure 28. Input IP2 vs. RF Frequency at Various LO Power Levels, TA = 25°C

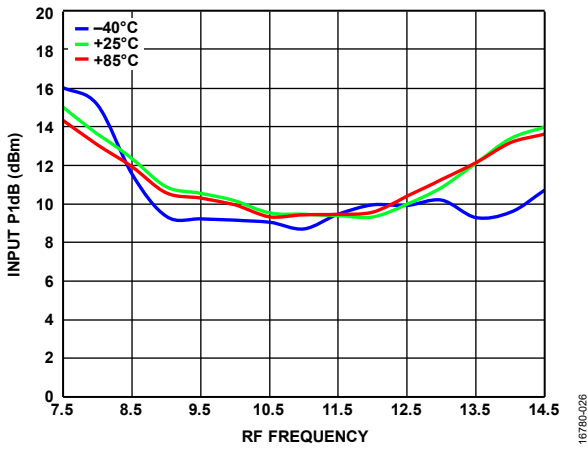

Figure 26. Input P1dB vs. RF Frequency at Various Temperatures, LO = 15 dBm

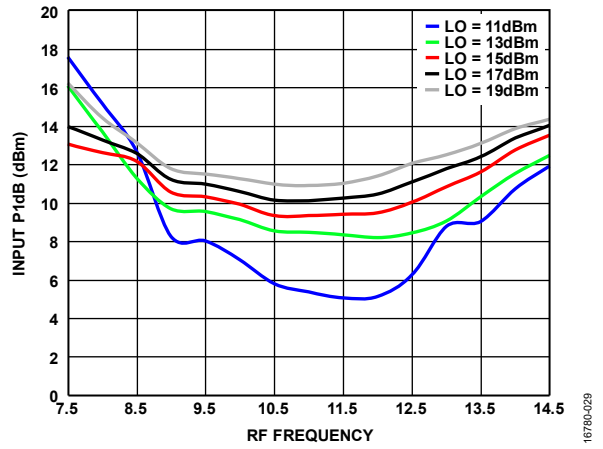

Figure 29. Input P1dB vs. RF Frequency at Various LO Power Levels, TA = 25°C

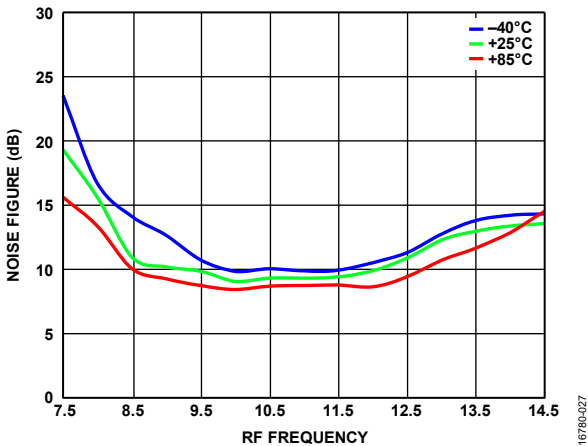

Figure 27. Noise Figure vs. RF Frequency at Various Temperatures, LO = 15 dBm

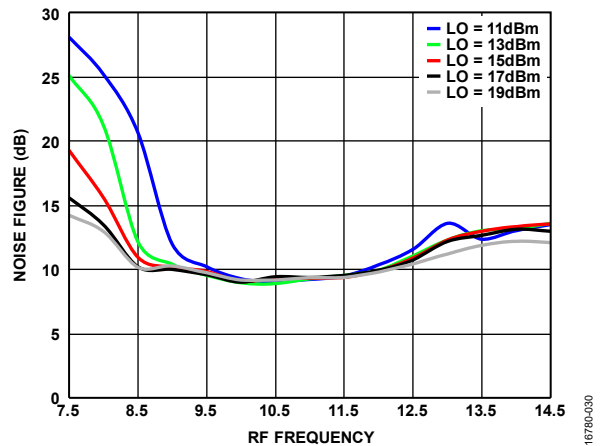

Figure 30. Noise Figure vs. RF Frequency at Various LO Power Levels, TA = 25°C

DOWNCONVERTER PERFORMANCE, IF = 3500 MHz

Upper Sideband (Low-Side LO)

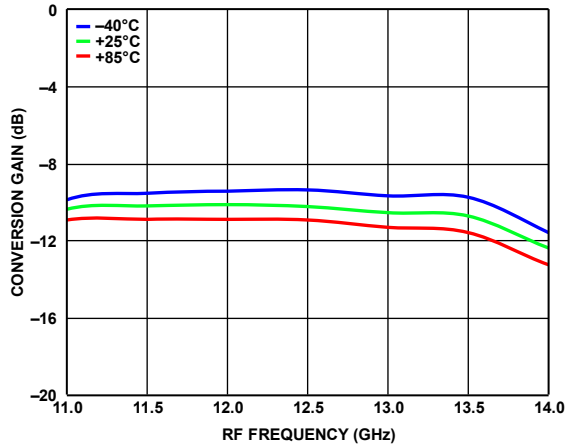

Figure 31. Conversion Gain vs. RF Frequency at Various Temperatures, LO = 15 dBm

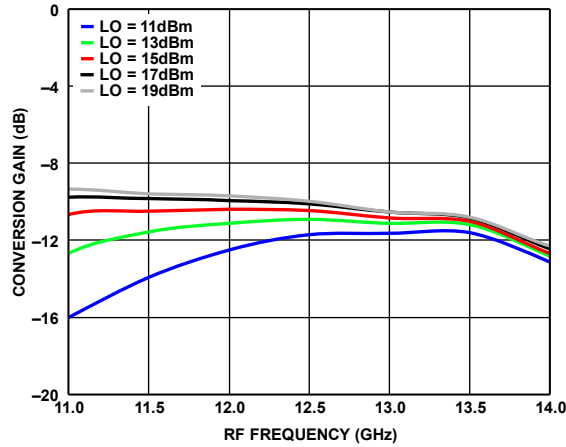

Figure 34. Conversion Gain vs. RF Frequency at Various LO Power Levels, TA = 25°C

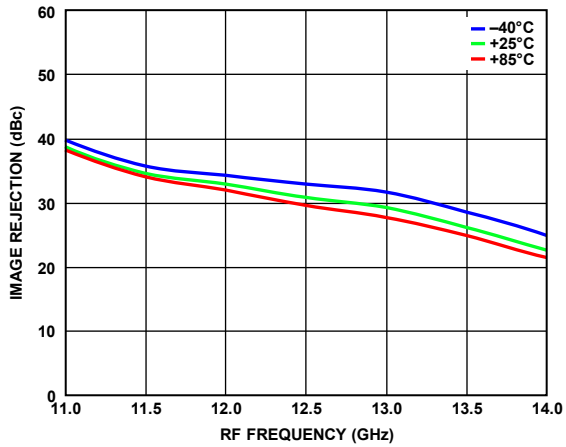

Figure 32. Image Rejection vs. RF Frequency at Various Temperatures, LO = 15 dBm

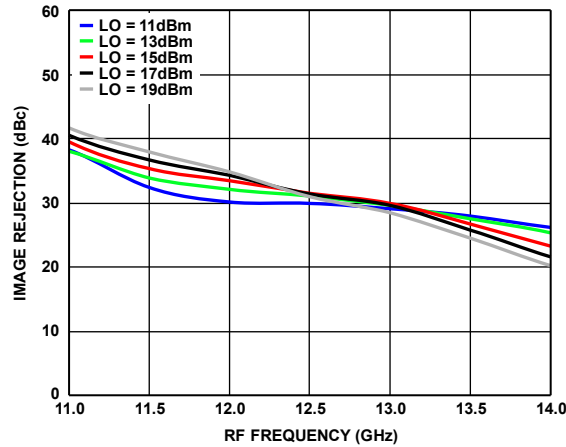

Figure 35. Image Rejection vs. RF Frequency at Various LO Power Levels, TA = 25°C

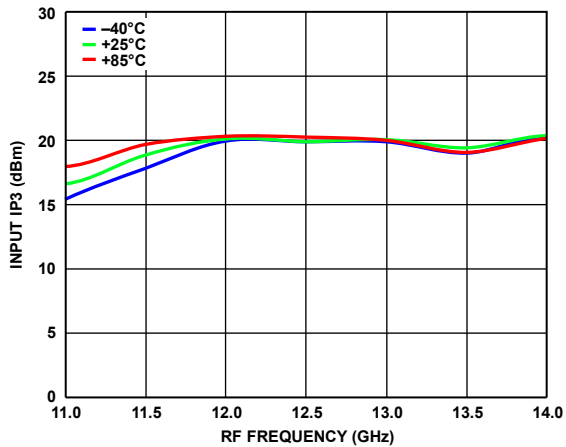

Figure 33. Input IP3 vs. RF Frequency at Various Temperatures, LO = 15 dBm

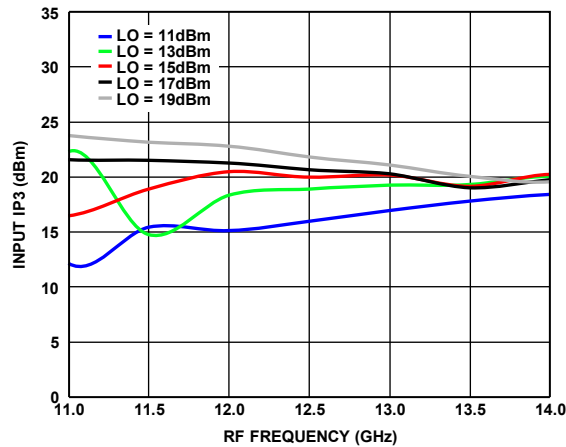

Figure 36. Input IP3 vs. RF Frequency at Various LO Power Levels, TA = 25°C

Lower Sideband (High-Side LO)

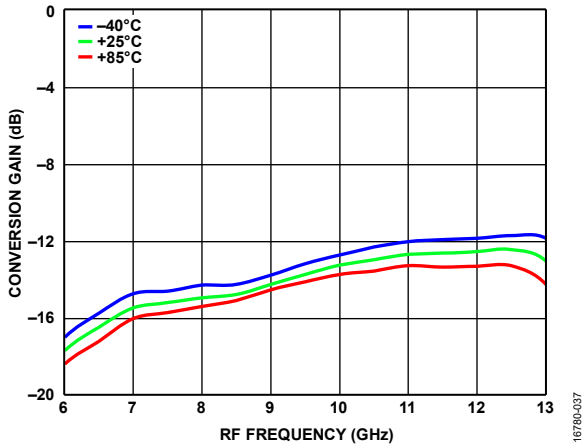

Figure 37. Conversion Gain vs. RF Frequency at Various Temperatures, LO = 15 dBm

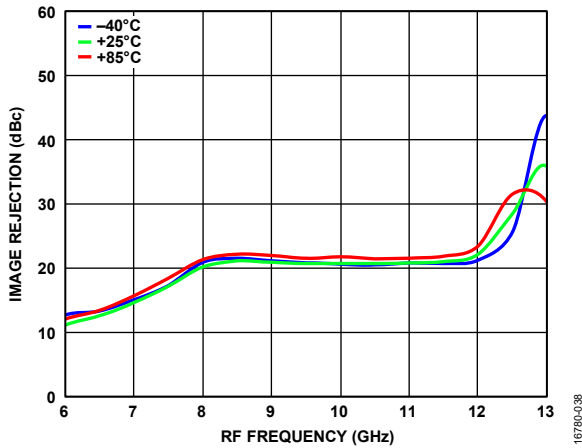

Figure 38. Image Rejection vs. RF Frequency at Various Temperatures, LO = 15 dBm

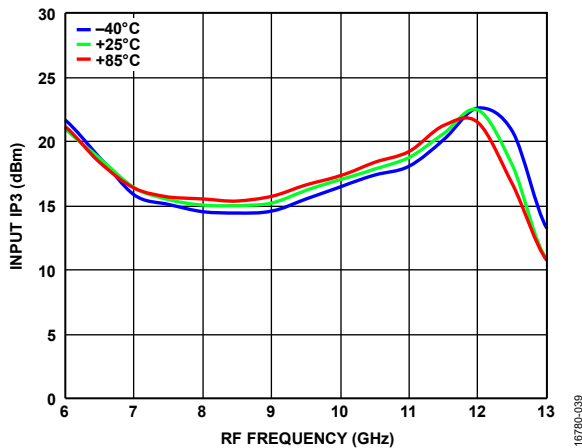

Figure 39. Input IP3 vs. RF Frequency at Various Temperatures, LO = 15 dBm

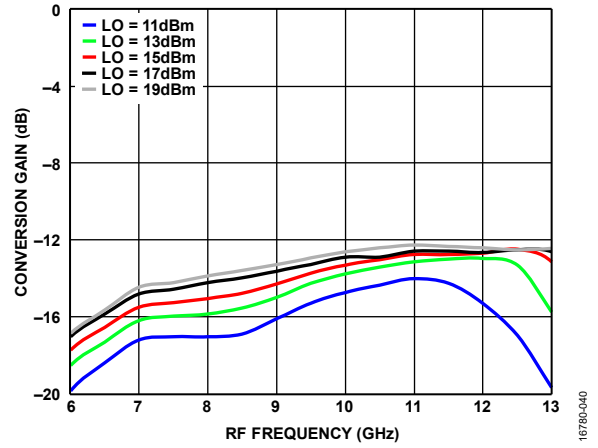

Figure 40. Conversion Gain vs. RF Frequency at Various LO Power Levels, TA = 25°C

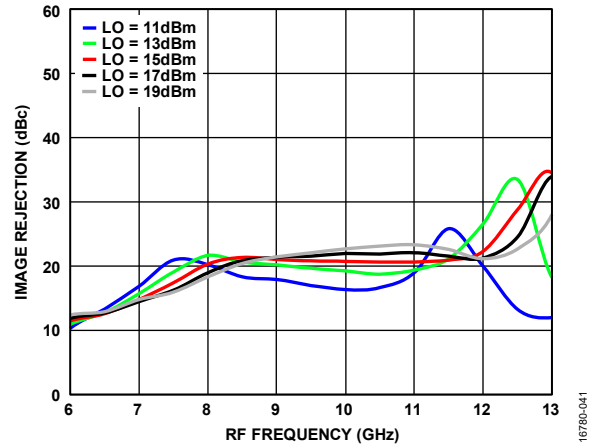

Figure 41. Image Rejection vs. RF Frequency at Various LO Power Levels, TA = 25°C

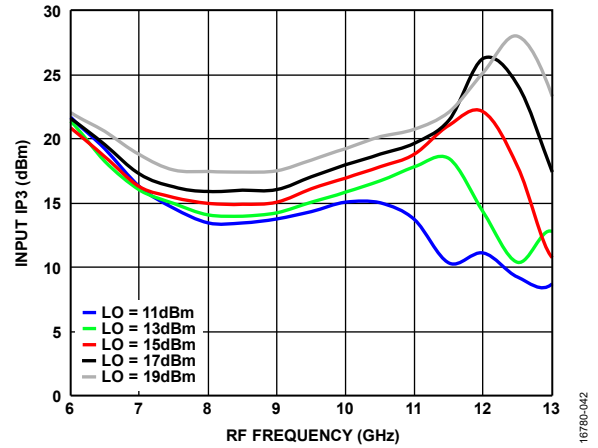

Figure 42. Input IP3 vs. RF Frequency at Various LO Power Levels, TA = 25°C

**UPCONVERTER PERFORMANCE, IF = 100 MHz**  
**Upper Sideband (Low-Side LO)**

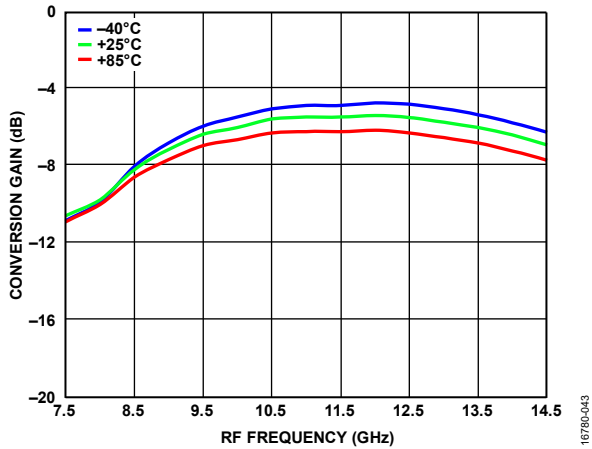

Figure 43. Conversion Gain vs. RF Frequency at Various Temperatures, LO = 15 dBm

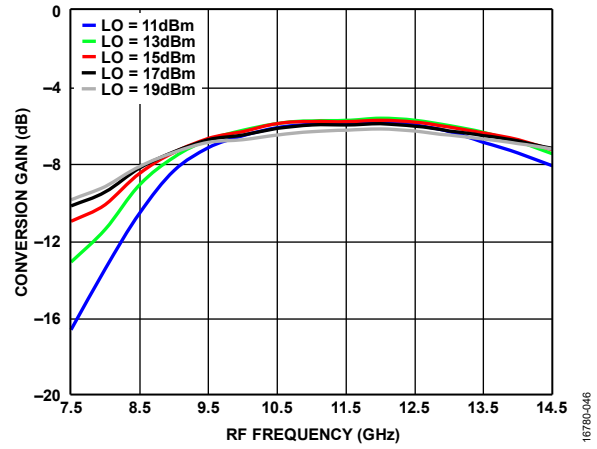

Figure 46. Conversion Gain vs. RF Frequency at Various LO Power Levels, TA = 25°C

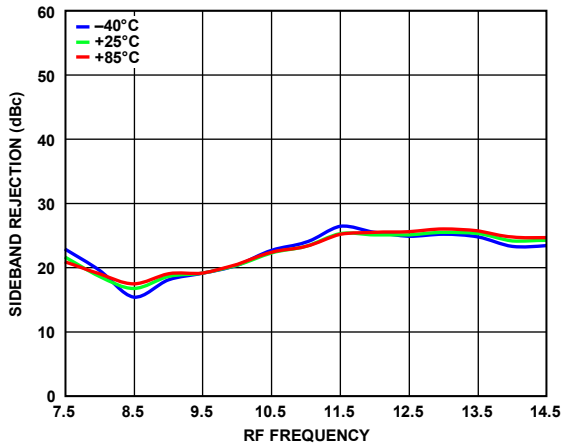

Figure 44. Sideband Rejection vs. RF Frequency at Various Temperatures, LO = 15 dBm

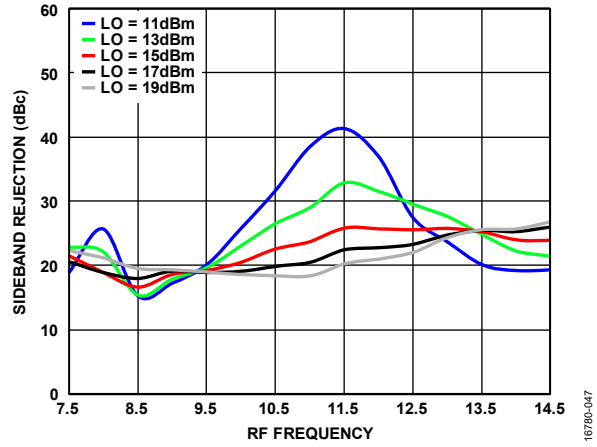

Figure 47. Sideband Rejection vs. RF Frequency at Various LO Power Levels, TA = 25°C

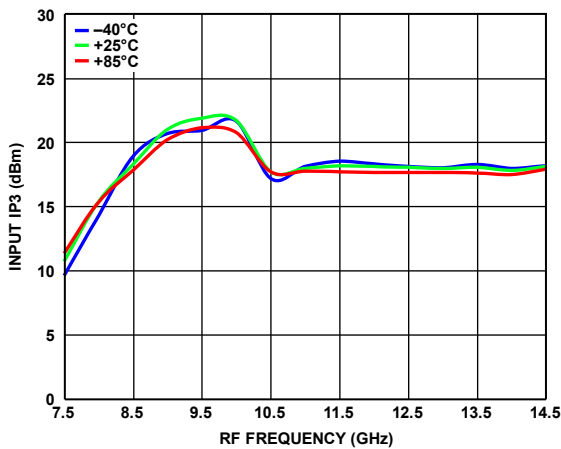

Figure 45. Input IP3 vs. RF Frequency at Various Temperatures, LO = 15 dBm

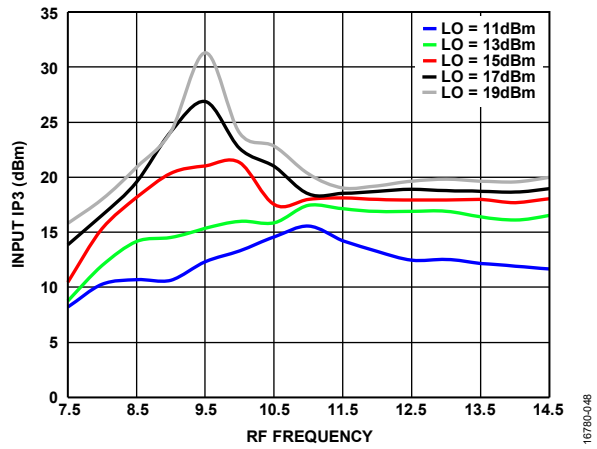

Figure 48. Input IP3 vs. RF Frequency at Various LO Power Levels, TA = 25°C

Lower Sideband (High-Side LO)

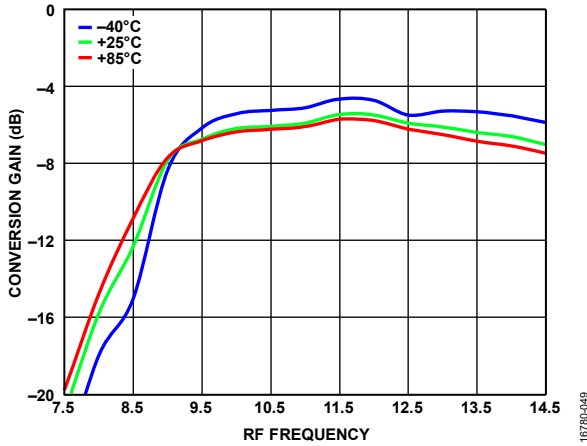

Figure 49. Conversion Gain vs. RF Frequency at Various Temperatures, LO = 15 dBm

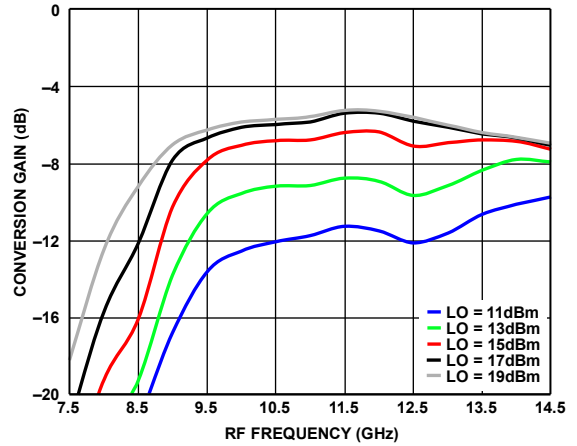

Figure 52. Conversion Gain vs. RF Frequency at Various LO Power Levels, TA = 25°C

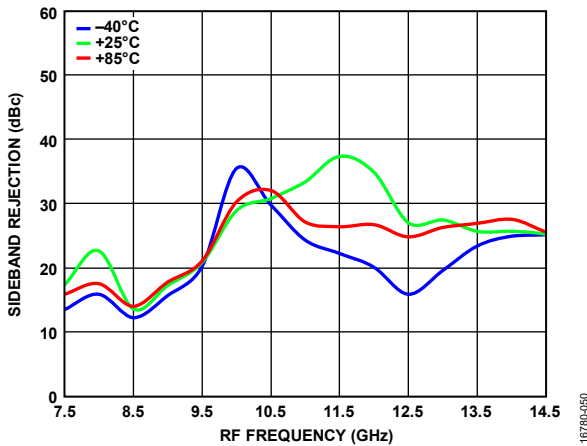

Figure 50. Sideband Rejection vs. RF Frequency at Various Temperatures, LO = 15 dBm

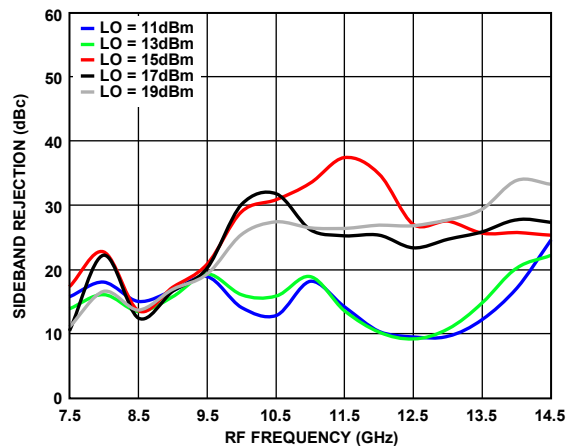

Figure 53. Sideband Rejection vs. RF Frequency at Various LO Power Levels, TA = 25°C

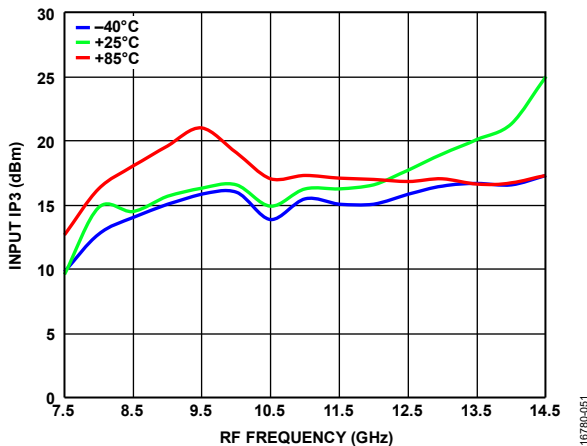

Figure 51. Input IP3 vs. RF Frequency at Various Temperatures, LO = 15 dBm

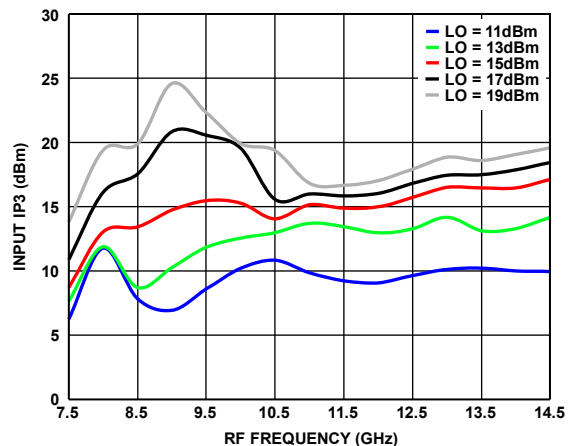

Figure 54. Input IP3 vs. RF Frequency at Various LO Power Levels, TA = 25°C

**UPCONVERTER PERFORMANCE, IF = 3500 MHz**  
**Upper Sideband (Low-Side LO)**

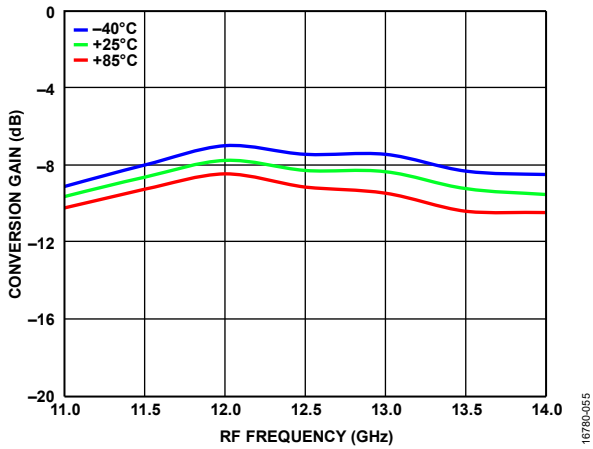

Figure 55. Conversion Gain vs. RF Frequency at Various Temperatures, LO = 15 dBm

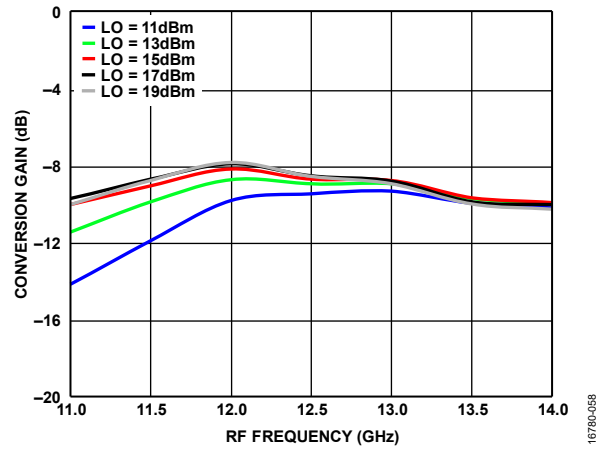

Figure 58. Conversion Gain vs. RF Frequency at Various LO Power Levels, TA = 25°C

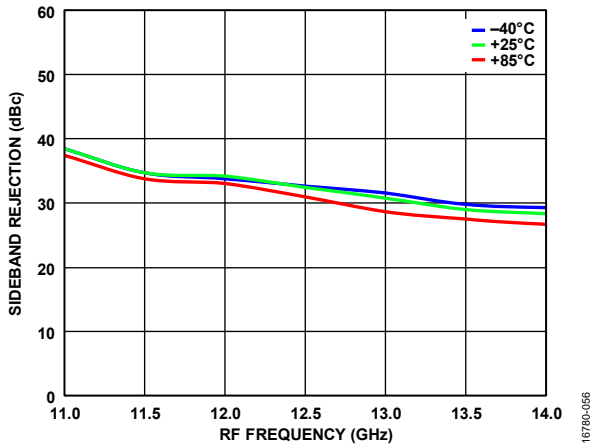

Figure 56. Sideband Rejection vs. RF Frequency at Various Temperatures, LO = 15 dBm

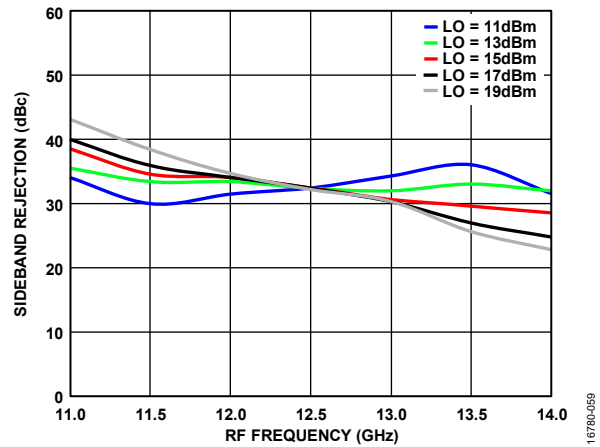

Figure 59. Sideband Rejection vs. RF Frequency at Various LO Power Levels, TA = 25°C

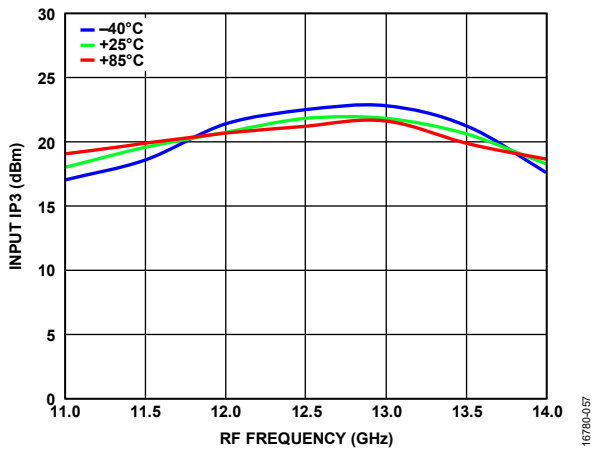

Figure 57. Input IP3 vs. RF Frequency at Various Temperatures, LO = 15 dBm

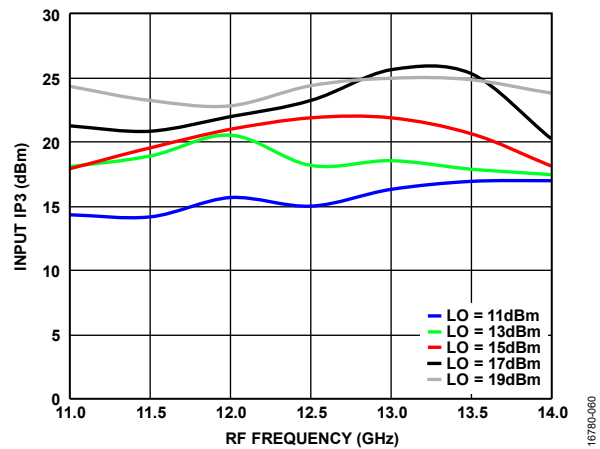

Figure 60. Input IP3 vs. RF Frequency at Various LO Power Levels, TA = 25°C

Lower Sideband (High-Side LO)

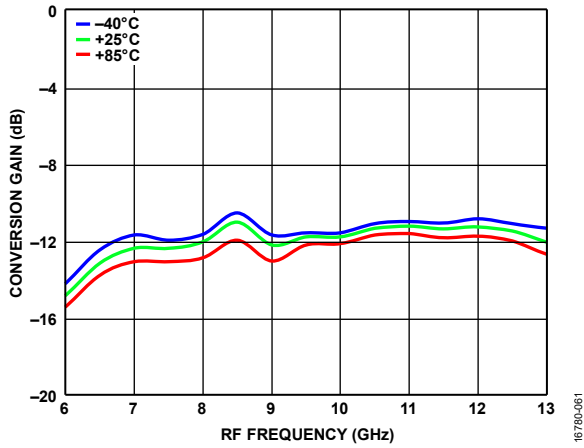

Figure 61. Conversion Gain vs. RF Frequency at Various Temperatures, LO = 15 dBm

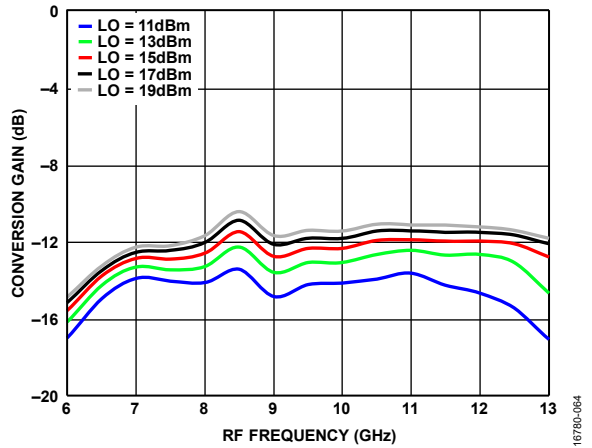

Figure 64. Conversion Gain vs. RF Frequency at Various LO Power Levels,  $T_A = 25^\circ\text{C}$

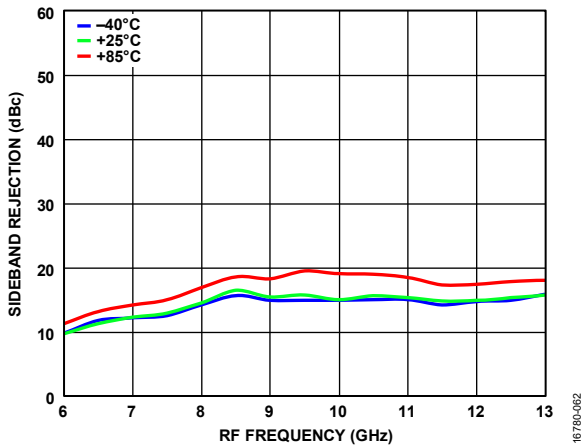

Figure 62. Sideband Rejection vs. RF Frequency at Various Temperatures, LO = 15 dBm

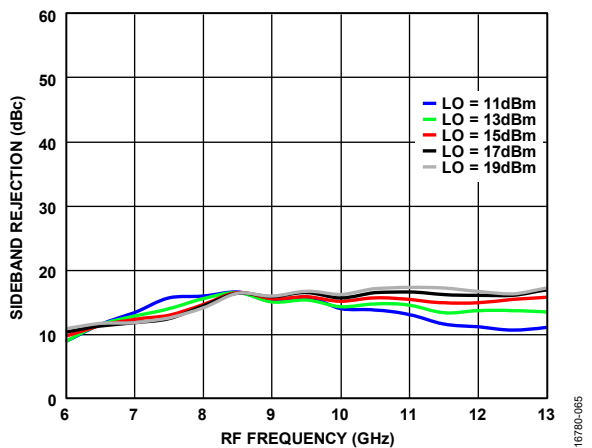

Figure 65. Sideband Rejection vs. RF Frequency at Various LO Power Levels,  $T_A = 25^\circ\text{C}$

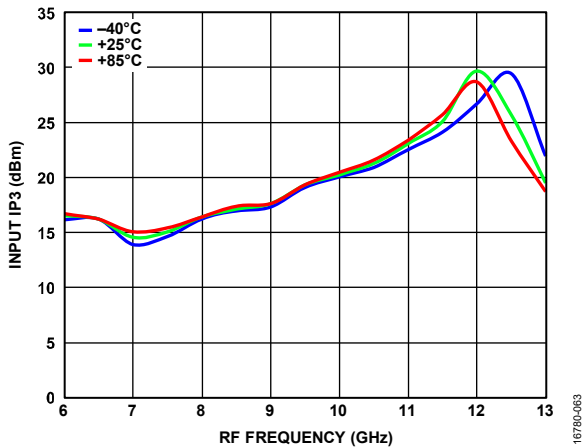

Figure 63. Input IP3 vs. RF Frequency at Various Temperatures, LO = 15 dBm

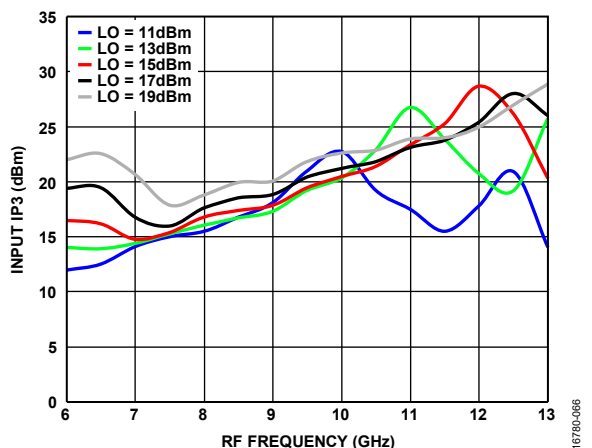

Figure 66. Input IP3 vs. RF Frequency at Various LO Power Levels,  $T_A = 25^\circ\text{C}$

Isolation and Return Loss

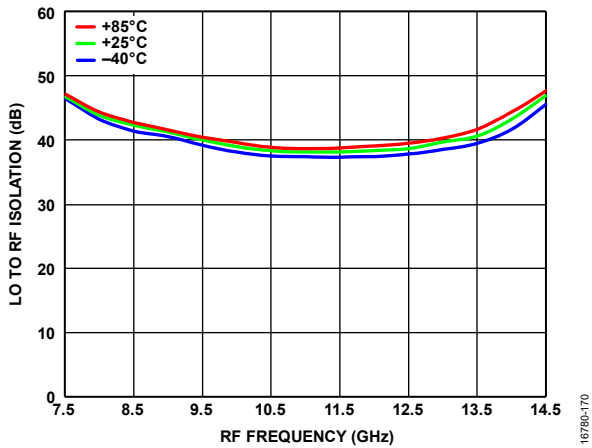

Figure 67. LO to RF Isolation vs. RF Frequency at Various Temperatures, LO = 15 dBm

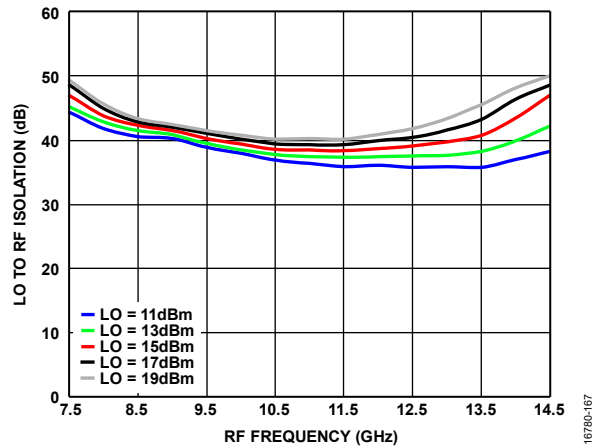

Figure 70. LO to RF Isolation vs. RF Frequency at Various LO Power Levels, TA = 25°C

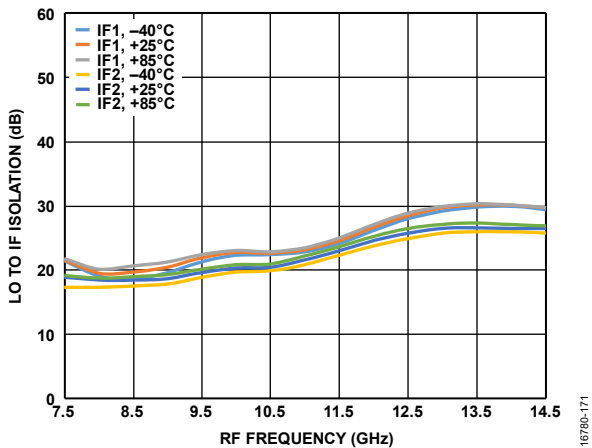

Figure 68. LO to IF Isolation vs. RF Frequency at Various Temperatures, LO = 15 dBm

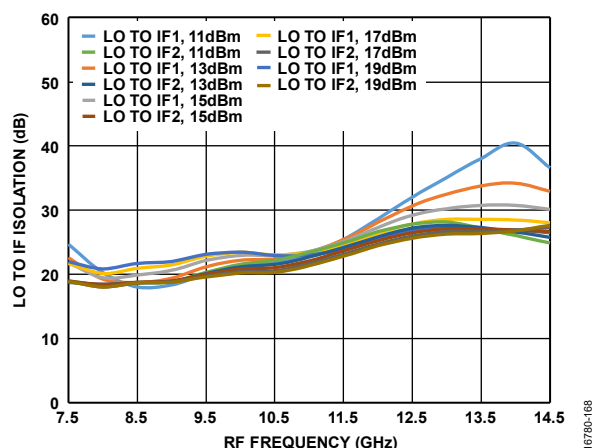

Figure 71. LO to IF Isolation vs. RF Frequency at Various LO Power Levels, TA = 25°C

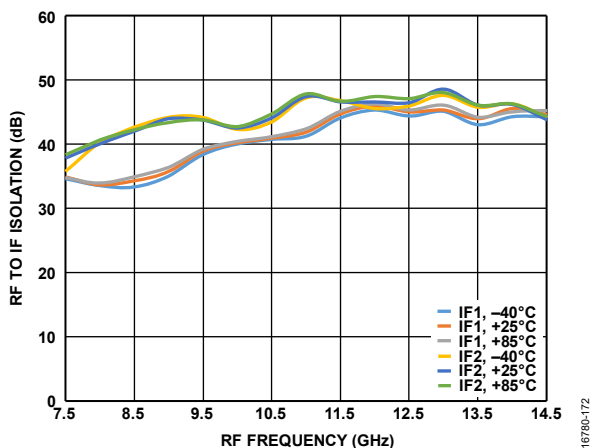

Figure 69. RF to IF Isolation vs. RF Frequency at Various Temperatures, LO = 15 dBm

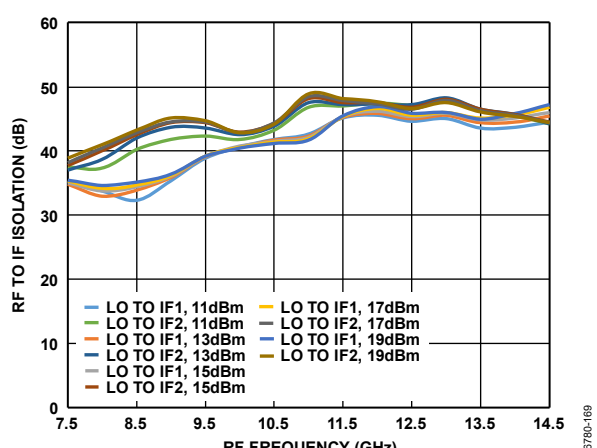

Figure 72. RF to IF Isolation vs. RF Frequency at Various LO Power Levels, TA = 25°C



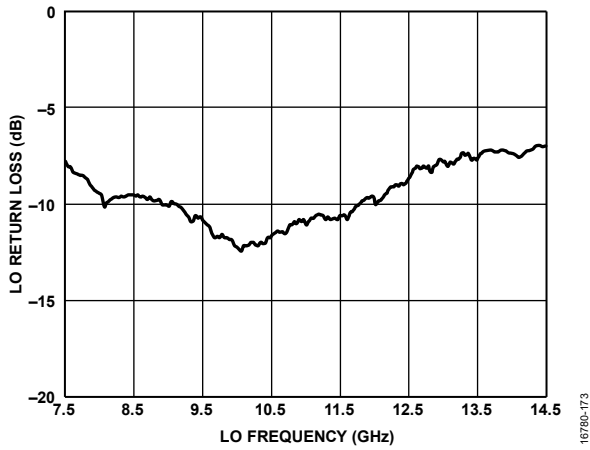

Figure 73. LO Return Loss vs. LO Frequency at LO = 13 dBm,  $T_A = 25^\circ\text{C}$

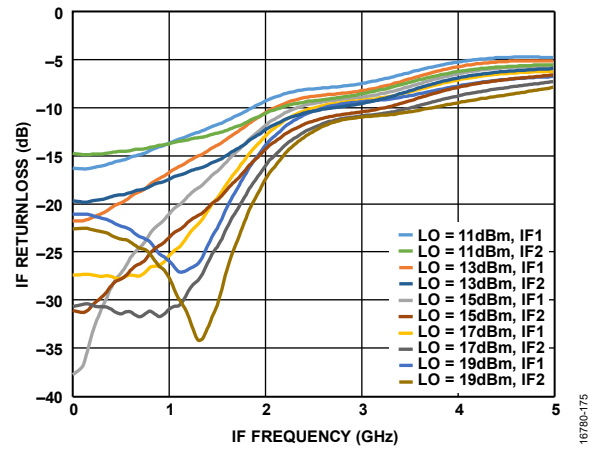

Figure 75. IF Return Loss vs. IF Frequency at Various LO Power Levels,  $T_A = 25^\circ\text{C}$ , LO = 10 GHz

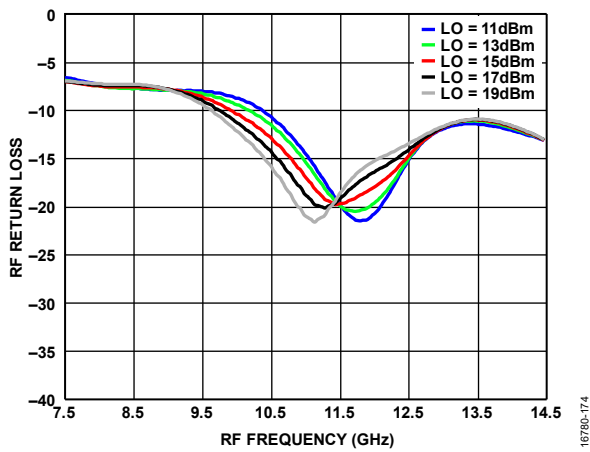

Figure 74. RF Return Loss vs. RF Frequency at Various LO Power Levels,  $T_A = 25^\circ\text{C}$ , LO = 10 GHz

**IF BANDWIDTH DOWNCONVERTER**

*Upper Sideband, LO Frequency = 8.5 GHz*

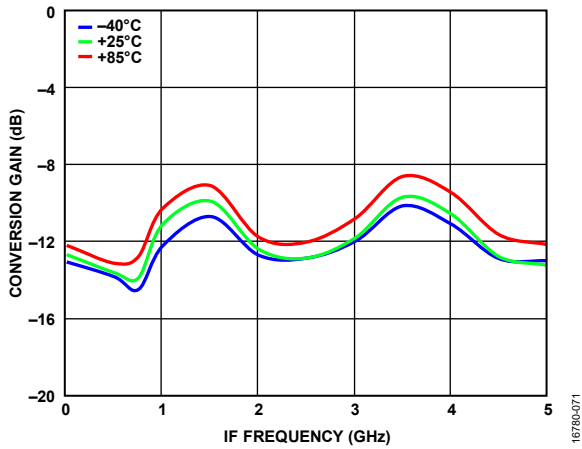

Figure 76. Conversion Gain vs. IF Frequency at Various Temperatures, LO = 15 dBm

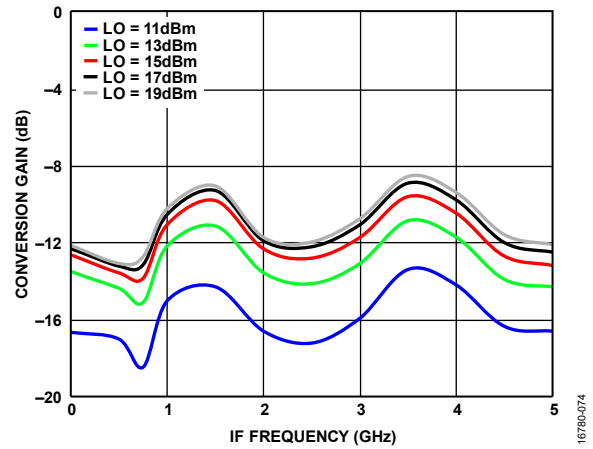

Figure 79. Conversion Gain vs. IF Frequency at Various LO Power Levels, TA = 25°C

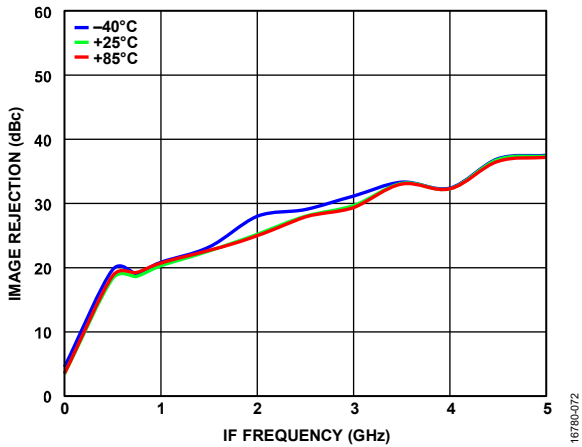

Figure 77. Image Rejection vs. IF Frequency at Various Temperatures, LO = 15 dBm

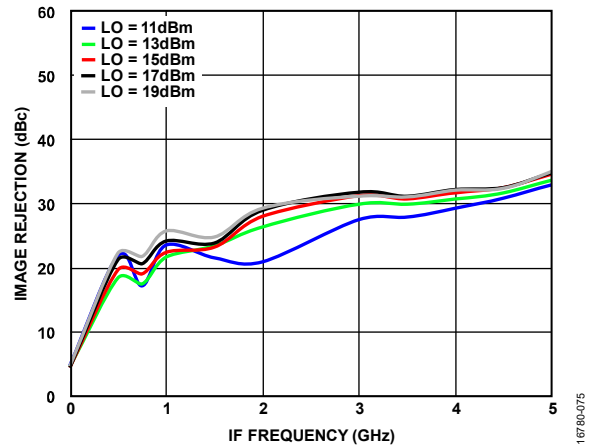

Figure 80. Image Rejection vs. IF Frequency at Various LO Power Levels, TA = 25°C

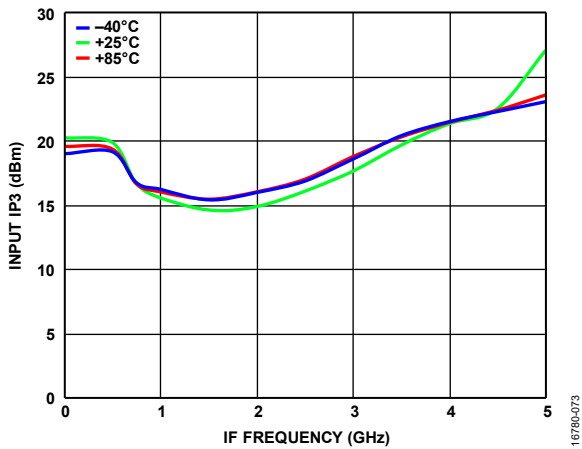

Figure 78. Input IP3 vs. IF Frequency at Various Temperatures, LO = 15 dBm

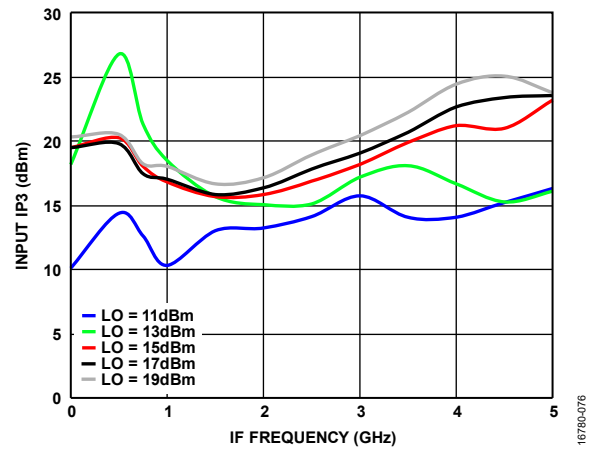

Figure 81. Input IP3 vs. IF Frequency at Various LO Power Levels, TA = 25°C

Amplitude/Phase Balance, Downconverter: IF = 100 MHz

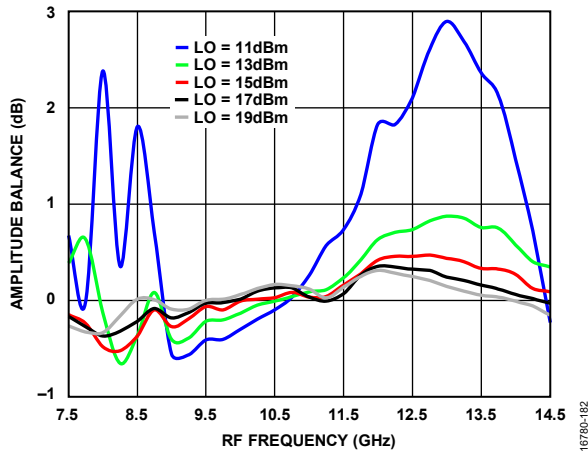

Figure 82. Amplitude Balance vs. RF Frequency at Various LO Powers, Upper Sideband,  $T_A = 25^\circ\text{C}$

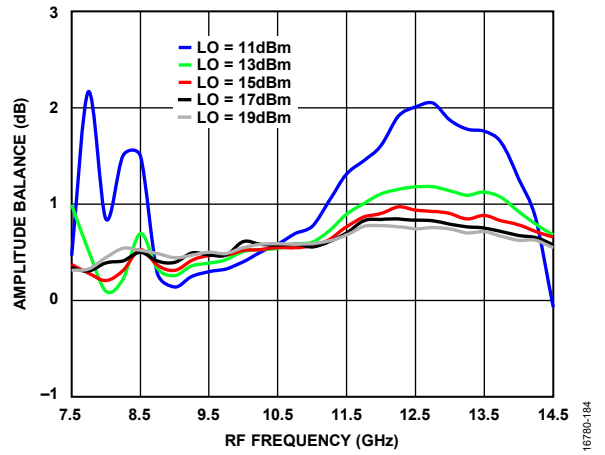

Figure 84. Amplitude Balance vs. RF Frequency at Various LO Powers, Lower Sideband,  $T_A = 25^\circ\text{C}$

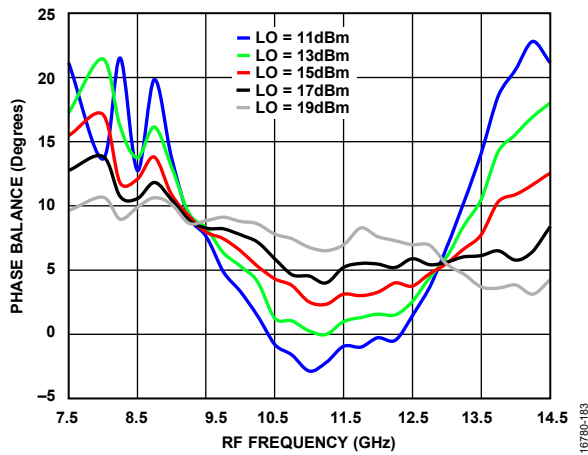

Figure 83. Phase Balance vs. RF Frequency at Various LO Powers, Upper Sideband,  $T_A = 25^\circ\text{C}$

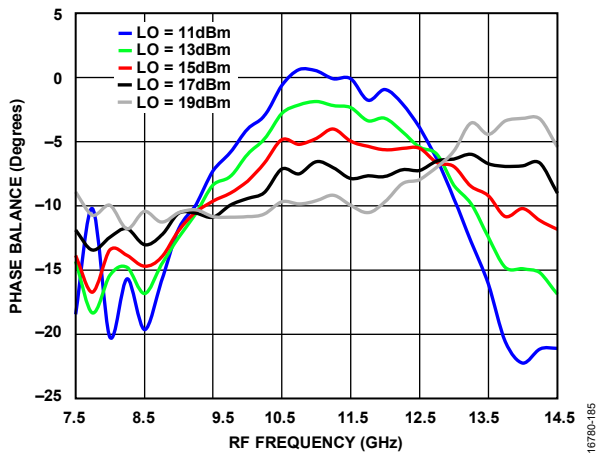

Figure 85. Phase Balance vs. RF Frequency at Various LO Powers, Lower Sideband,  $T_A = 25^\circ\text{C}$

**SPURIOUS AND HARMONICS PERFORMANCE**

Mixer spurious products are measured in dBc from the IF output power level. N/A means not applicable.

**LO Harmonics**

LO = 15 dBm, all values in dBc are below input LO level and are measured at the RF port.

**Table 5. LO Harmonics at RF**

LO Frequency (GHz)	N × LO Spur at RF Port			
	1	2	3	4
6.5	56	39	54	60
7.5	50	31	49	67
8.5	44	36	50	68
9.5	41	42	49	64
10.5	40	59	60	51
11.5	40	53	68	53
12.5	40	58	56	60
13.5	41	72	57	N/A
14.5	48	57	56	N/A
15.5	53	61	54	N/A

LO = 15 dBm, all values in dBc are below input LO level and are measured at the IF ports.

**Table 6. LO Harmonics at IF1**

LO Frequency (GHz)	N × LO Spur at IF1 Port			
	1	2	3	4
6.5	26	64	57	80
7.5	23	55	77	86
8.5	20	69	53	89
9.5	22	61	54	87
10.5	25	68	64	76
11.5	27	70	59	72
12.5	32	55	59	85
13.5	33	69	64	N/A
14.5	32	72	78	N/A
15.5	26	68	66	N/A

**Table 7. LO Harmonics at IF2**

LO Frequency (GHz)	N × LO Spur at IF2 Port			
	1	2	3	4
6.5	24	59	60	81
7.5	20	55	72	74
8.5	19	63	54	73
9.5	21	56	49	79
10.5	23	68	53	91
11.5	25	68	53	76
12.5	29	55	64	82
13.5	29	66	74	N/A
14.5	28	58	90	N/A
15.5	28	66	82	N/A

**M × N Spurious Outputs**

**Downconverter, Upper Sideband**

Spur values are (M × RF) – (N × LO).

RF = 10.6 GHz at –10 dBm, LO = 10.5 GHz at 15 dBm.

M × RF	N × LO						
	0	1	2	3	4	5	
0	N/A	–8	+32	+45	N/A	N/A	
1	+32	0	+38	+53	+70	N/A	
2	+77	+69	+60	+50	+76	+73	
3	+73	+77	+79	+57	+80	+77	
4	N/A	+65	+76	+77	+85	+79	
5	N/A	N/A	+55	+74	+80	+87	

**Upconverter, Upper Sideband**

Spur values are (M × IF) + (N × LO).

IF<sub>IN</sub> = 100 MHz at –10 dBm, LO = 10.5 GHz at 15 dBm.

M × IF	N × LO			
	0	1	2	3
+5	88	70	76	N/A
+4	90	72	74	N/A
+3	88	44	N/A	N/A
+2	88	61	N/A	N/A
+1	79	N/A	N/A	N/A
0	N/A	9	40	36
–1	79	0	31	44
–2	90	61	57	67
–3	86	44	75	75
–4	87	71	78	75
–5	89	70	75	76

## THEORY OF OPERATION

The HMC521ALC4 is a MMIC mixer in a 24-terminal, RoHS compliant, ceramic LCC package. The device can be used as either an image reject mixer or a single sideband upconverter. The mixer uses two standard, double balanced mixer cells and a 90° hybrid fabricated in a GaAs, MESFET process. This device is a much smaller alternative to a hybrid style image reject mixer and a single sideband upconverter assembly. The HMC521ALC4 eliminates the need for wire bonding, allowing the use of surface-mount

manufacturing techniques. When used as an image reject mixer, the HMC521ALC4 downconverts radio frequencies between 8.5 GHz and 13.5 GHz to intermediate frequencies between dc and 3.5 GHz. When used as single sideband upconverter, the HMC521ALC4 upconverts intermediate frequencies between dc and 3.5 GHz to RF between 8.5 GHz and 13.5 GHz.

## APPLICATIONS INFORMATION

### TYPICAL APPLICATION CIRCUIT

Figure 86 shows the typical application circuit for the HMC521ALC4. The HMC521ALC4 is a passive device and does not require any external components. The LO and RF pins are internally ac-coupled. The IFx pins are internally dc-coupled. For applications not requiring operation to dc, dc block this port externally using a series capacitor of a value chosen to pass the necessary IF frequency range. When IF operation to dc is required, do not exceed the IFx source and sink current rating specified in the Absolute Maximum Ratings section. To select the upper sideband when using the HMC521ALC4 as an upconverter, connect the IF1 pin to the 90° port of the hybrid, and

and connect the IF2 pin to the 0° port of the hybrid. To select the lower sideband, connect the IF1 pin to the 0° port of the hybrid and the IF2 pin to the 90° port of the hybrid. The input is from the sum port of the hybrid, and the difference port is 50 Ω terminated.

To select the upper sideband (low-side LO) when using as downconverter, connect the IF1 pin to the 0° port of the hybrid, and connect the IF2 pin to the 90° port of the hybrid. To select the lower sideband (high-side LO), connect the IF1 pin to the 90° port of the hybrid and connect the IF2 pin to the 0° port of the hybrid. The output is from the sum port of the hybrid, and the difference port is 50 Ω terminated.

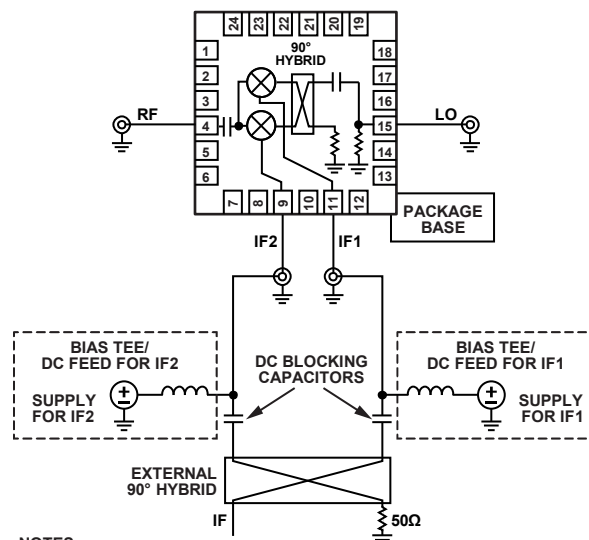

NOTES  
1. DASHED SECTIONS ARE OPTIONAL AND MEANT FOR LO NULLING.

Figure 86. Typical Application Circuit

16780-157

**EVALUATION PCB INFORMATION**

Use RF circuit design techniques for the circuit board used in the application. Ensure that signal lines have 50 Ω impedance and connect the package ground leads and the exposed pad directly to the ground plane (see Figure 87). Use a sufficient number of via holes to connect the top and bottom ground planes. The evaluation circuit board shown in Figure 87 is available from Analog Devices, Inc., upon request.

**Table 8. List of Materials for Evaluation PCB**  
**EV1HMC521ALC4**

Item	Description
J1, J2	PCB mount, SRI, 2.92 mm connectors
J3, J4	PCB mount, Johnson SMA connectors
U1	HMC521ALC4
PCB <sup>1</sup>	109996-1 evaluation board on Rogers 4350

<sup>1</sup> 109996-1 is the raw bare PCB identifier. Reference EV1HMC521ALC4 when ordering the complete evaluation PCB.

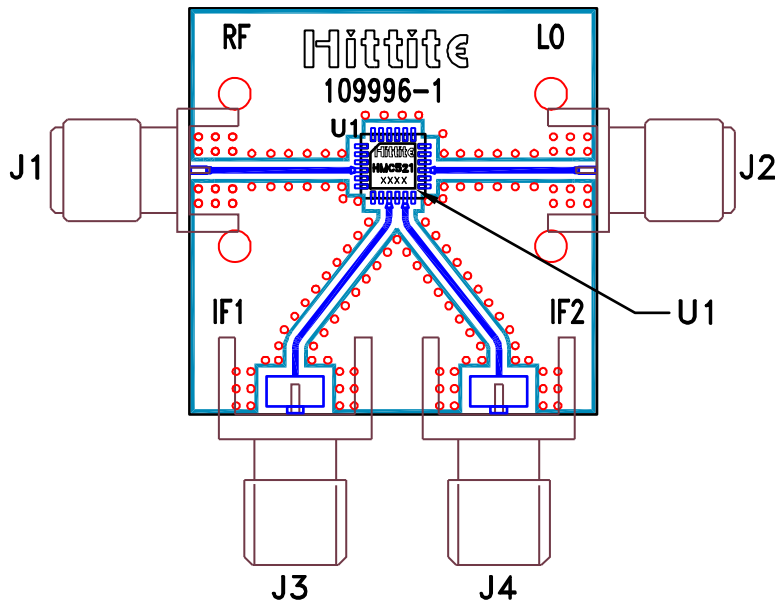

Figure 87. Evaluation PCB Top Layer

OUTLINE DIMENSIONS

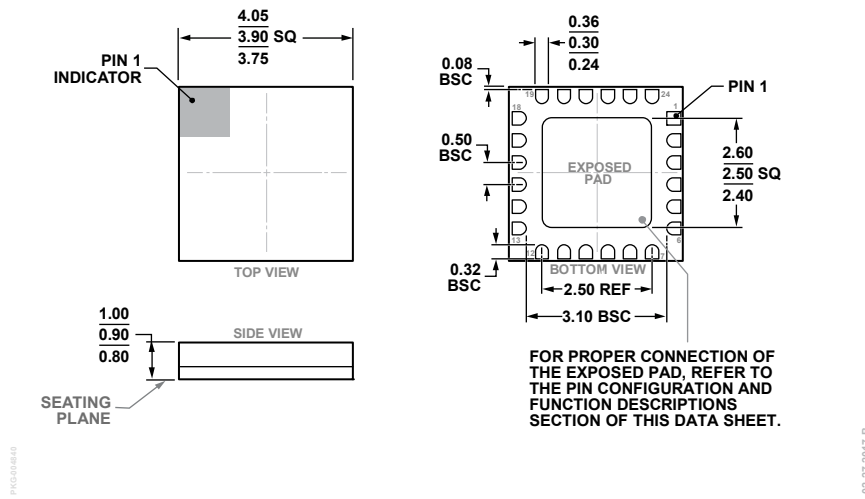

Figure 88. 24-Terminal Ceramic Leadless Chip Carrier [LCC] (E-24-1)  
Dimensions shown in millimeters

ORDERING GUIDE

Model <sup>1</sup>	Temperature Range	MSL Rating <sup>2</sup>	Package Description	Package Option
HMC521ALC4	-40°C to +85°C	MSL3	24-Terminal Ceramic Leadless Chip Carrier [LCC]	E-24-1
HMC521ALC4TR	-40°C to +85°C	MSL3	24-Terminal Ceramic Leadless Chip Carrier [LCC]	E-24-1
HMC521ALC4TR-R5	-40°C to +85°C	MSL3	24-Terminal Ceramic Leadless Chip Carrier [LCC]	E-24-1
EV1HMC521ALC4			Evaluation PCB Assembly	

<sup>1</sup> All models are RoHS compliant.

<sup>2</sup> See the Absolute Maximum Ratings section, Table 2.



## X-ON Electronics

Largest Supplier of Electrical and Electronic Components

*Click to view similar products for [RF Mixer](#) category:*

*Click to view products by [Analog Devices](#) manufacturer:*

Other Similar products are found below :

[F1751NBGI](#) [MD-169-PIN](#) [MD-154-PIN](#) [CHR3664-QEG](#) [M85C](#) [LTC5567IUF#TRPBF](#) [HMC553ALC3BTR-R5](#) [HMC787ALC3BTR-R5](#)  
[LTC5541IUH#TRPBF](#) [SIM-63LH+](#) [MCA1-24+](#) [SIM-24MH+](#) [F1192BNLGK8](#) [AD608ARZ-RL](#) [EMRS-1TR](#) [F0552NLGI](#) [F1701NBGI](#)  
[F0502NLGI](#) [F1763NBGI](#) [MDS-189-PIN](#) [MAMXSS0012TR-3000](#) [M2TC](#) [M2A](#) [CSM4T](#) [LTC5553IUDB#TRMPBF](#) [LT5527EUF#PBF](#)  
[LTC5577IUF#PBF](#) [M1H](#) [LTC5548IUDB#TRMPBF](#) [MY63H](#) [SMA5101-TL-H](#) [ADL5801ACPZ](#) [AD831APZ](#) [AD831APZ-REEL7](#)  
[ADL5350ACPZ-R7](#) [ADL5801ACPZ-R7](#) [HMC219BMS8GETR](#) [HMC220BMS8GE](#) [HMC412BMS8GE](#) [HMC557ALC4](#) [HMC787ALC3BTR](#)  
[LT5560EDD#PBF](#) [GRF7001](#) [HMC220BMS8GETR](#) [CSM4T17](#) [CSM4TH](#) [CSM5TH](#) [MAMX-011021-TR1000](#) [MAMX-011035-TR0100](#)  
[MAMX-011036-TR0100](#)