

**FEATURES**

**Passive: no dc bias required**  
**Conversion loss: 11 dB maximum (downconverter)**  
**Input IP3: 17 dBm minimum (downconverter)**  
**LO to RF Isolation: 43 dB minimum**  
**IFx pad frequency range: dc to 3.5 GHz**  
**12-pad, RoHS compliant, bare die (CHIP)**

**APPLICATIONS**

**Test and measurement instrumentation**  
**Military, aerospace, and defense applications**  
**Microwave point to point base stations**

**GENERAL DESCRIPTION**

The HMC525ACHIPS is a compact gallium arsenide (GaAs), monolithic microwave integrated circuit (MMIC), in phase and quadrature (I/Q), RoHS compliant mixer. The device can be used as either an image reject mixer or a single sideband upconverter. The mixer uses two standard double balanced mixer cells and a 90° hybrid fabricated in a GaAs, metal

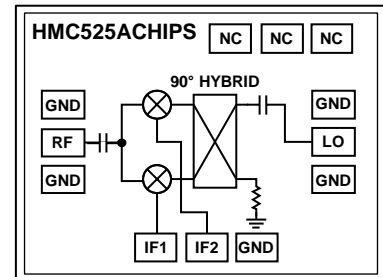
**FUNCTIONAL BLOCK DIAGRAM***Figure 1.*

semiconductor field effect transistor (MESFET) process. The HMC525ACHIPS is a much smaller alternative to a hybrid style image reject mixer and a single sideband upconverter assembly. The HMC525ACHIPS eliminates the need for wire bonding, allowing the use of surface-mount manufacturing techniques.

**TABLE OF CONTENTS**

Features .....	1	Interface Schematics .....	5
Applications .....	1	Typical Performance Characteristics .....	6
Functional Block Diagram .....	1	Downconverter Performance .....	6
General Description .....	1	Upconverter Performance .....	18
Revision History .....	2	Spurious and Harmonics Performance .....	24
Specifications .....	3	Theory of Operation .....	25
Absolute Maximum Ratings .....	4	Applications Information .....	26
Electrostatic Discharge (ESD) Ratings .....	4	Outline Dimensions .....	27
ESD Caution .....	4	Ordering Guide .....	27
Pin Configuration and Function Descriptions .....	5		

**REVISION HISTORY**

10/2020—Revision 0: Initial Version

## SPECIFICATIONS

$T_A = 25^\circ\text{C}$ , intermediate frequency (IF) = 100 MHz, LO drive = 15 dBm, all measurements were performed as a downconverter with a lower sideband selected, with an external  $90^\circ$  hybrid at the IFx ports, and a LO amplifier in line with the lab bench LO source, unless otherwise noted.

**Table 1.**

Parameter	Test Conditions/Comments	Min	Typ	Max	Unit
<b>FREQUENCY RANGE</b>					
RF Pad		4		8.5	GHz
LO Pad		4		8.5	GHz
IFx Pad		DC		3.5	GHz
<b>LO AMPLITUDE</b>					
		13	15	17	dBm
<b>4 GHz to 8.5 GHz PERFORMANCE</b>					
Downconverter	Taken as image reject mixer				
Conversion Loss			8	11	dB
Noise Figure			10.5		dB
Input Third-Order Intercept (IP3)		17	21		dBm
Input Power for 1dB Compression (P1dB)			13		dBm
Image Rejection		21	31		dBc
Upconverter	Taken as single sideband upconverter mixer				
Conversion Loss			7		dB
Input IP3			19		dBm
Input P1dB			8.5		dBm
Sideband Rejection			22		dBc
Isolation	Taken without external $90^\circ$ IF hybrid				
LO to RF		43	46		dB
LO to IF			24		dB
RF to IF			43		dB
Balance	Taken without external $90^\circ$ IF hybrid				
Phase			0.24		Degrees
Amplitude			0.65		dB
<b>4.5 GHz to 6 GHz PERFORMANCE</b>					
Downconverter	Taken as image reject mixer				
Conversion Loss			7.5	11	dB
Noise Figure			10		dB
Input IP3		17	20.5		dBm
Input P1dB			11.5		dBm
Image Rejection		25	31.5		dBc
Upconverter	Taken as single sideband upconverter mixer				
Conversion Loss			6.6		dB
Input IP3			20		dBm
Input P1dB			9.9		dBm
Sideband Rejection			22.5		dBc
Isolation	Taken without external $90^\circ$ IF hybrid				
LO to RF		43	44.5		dB
LO to IF			21.5		dB
RF to IF			42.5		dB
Balance	Taken without external $90^\circ$ IF hybrid				
Phase			0.09		Degrees
Amplitude			0.8		dB

## ABSOLUTE MAXIMUM RATINGS

Table 2.

Parameter	Rating
Input Power	
RF	20 dBm
LO	25 dBm
IF	20 dBm
IF Source and Sink Current	2 mA
Continuous Power Dissipation, P <sub>DISS</sub> (T <sub>A</sub> = 85°C, Derate 6.22 mW/°C Above 85°C)	560 mW
Temperature	
Maximum Junction (T <sub>J</sub> )	175°C
Reflow	260°C
Operating Range	–40°C to +85°C
Storage Range	–65°C to +150°C

Stresses at or above those listed under Absolute Maximum Ratings may cause permanent damage to the product. This is a stress rating only; functional operation of the product at these or any other conditions above those indicated in the operational section of this specification is not implied. Operation beyond the maximum operating conditions for extended periods may affect product reliability.

## ELECTROSTATIC DISCHARGE (ESD) RATINGS

The following ESD information is provided for handling of ESD-sensitive devices in an ESD protected area only.

Human body model (HBM) per ANSI/ESDA/JEDDEC JS-001.

Field induced charged device model (FICDM) per ANSI/ESDA/JEDEC JS-002.

### ESD Ratings ADPA7004CHIP

Table 3. HMC525ACHIPS, 12-Pad CHIP

ESD Model	Withstand Threshold (V)	Class
HBM	250	1A
FICDV	500	C2A

## ESD CAUTION



**ESD (electrostatic discharge) sensitive device.** Charged devices and circuit boards can discharge without detection. Although this product features patented or proprietary protection circuitry, damage may occur on devices subjected to high energy ESD. Therefore, proper ESD precautions should be taken to avoid performance degradation or loss of functionality.

# PIN CONFIGURATION AND FUNCTION DESCRIPTIONS

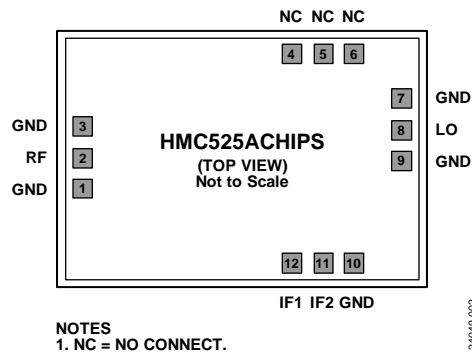

Figure 2. Pin Configuration

Table 4. Pin Function Descriptions

Pin No.	Mnemonic	Description
1, 3, 7, 9, 10	GND	Ground. The GND pads must be connected to RF and dc ground. See Figure 3 for the interface schematic.
2	RF	Radio Frequency Input and Output. The RF pad is dc-coupled and matched to 50 Ω when LO is on. See Figure 4 for the interface schematic.
4, 5, 6	NC	No Connect.
8	LO	Local Oscillator Input. The LO pad is dc-coupled and matched to 50 Ω when LO is on. See Figure 5 for the interface schematic.
11, 12	IF2, IF1	First and Second Quadrature Intermediate Frequency Input and Output Pads. The IFx pads are dc-coupled. For applications not requiring operation to dc, use an off-chip dc blocking capacitor. For operations to dc, the IFx pads must not source or sink more than 3 mA of current. Otherwise, the device may not function and may fail. See Figure 6 for the interface schematic.

## INTERFACE SCHEMATICS



Figure 3. GND Interface Schematic

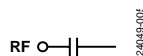

Figure 4. RF Interface Schematic

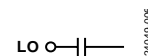

Figure 5. LO Interface Schematic

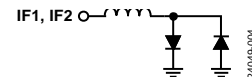

Figure 6. IF1, IF2 Interface Schematic

# TYPICAL PERFORMANCE CHARACTERISTICS

## DOWNCONVERTER PERFORMANCE

IF = 100 MHz, Lower Sideband (High-Side LO)

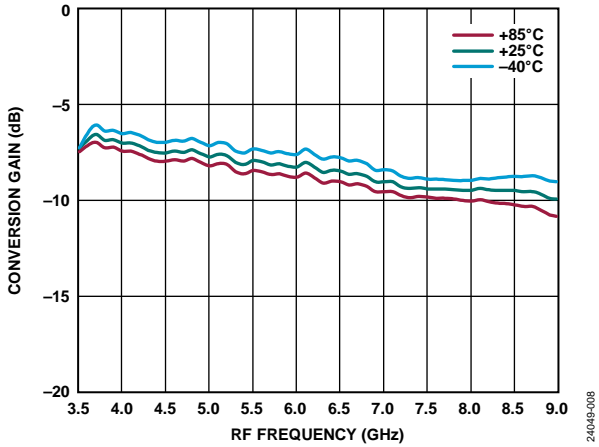

Figure 7. Conversion Gain vs. RF Frequency at Various Temperatures, LO Drive = 15 dBm

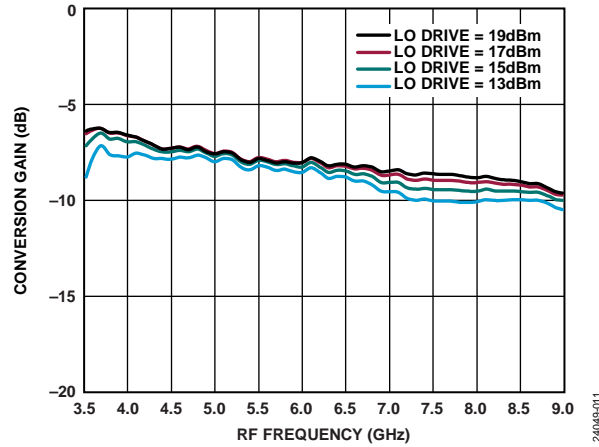

Figure 10. Conversion Gain vs. RF Frequency at Various LO Drives,  $T_A = 25^\circ\text{C}$

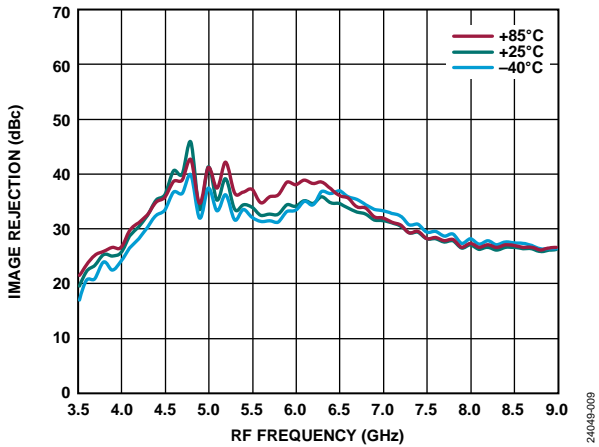

Figure 8. Image Rejection vs. RF Frequency at Various Temperatures, LO Drive = 15 dBm

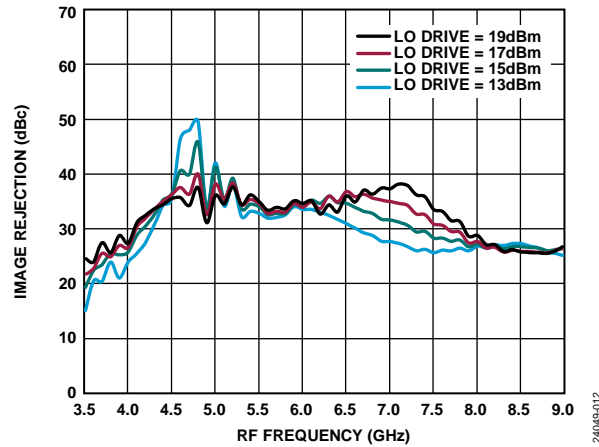

Figure 11. Image Rejection vs. RF Frequency at Various LO Drives,  $T_A = 25^\circ\text{C}$

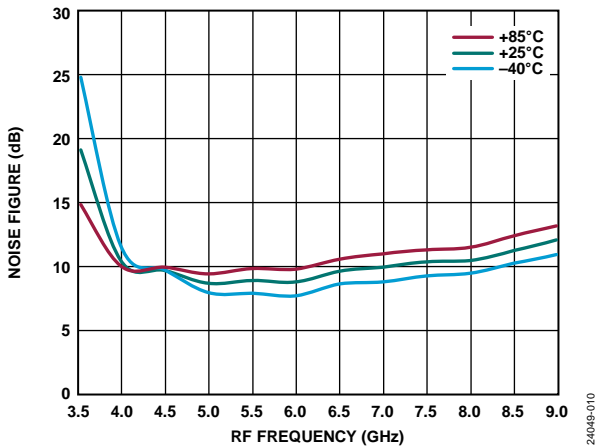

Figure 9. Noise Figure vs. RF Frequency at Various Temperatures, LO Drive = 15 dBm

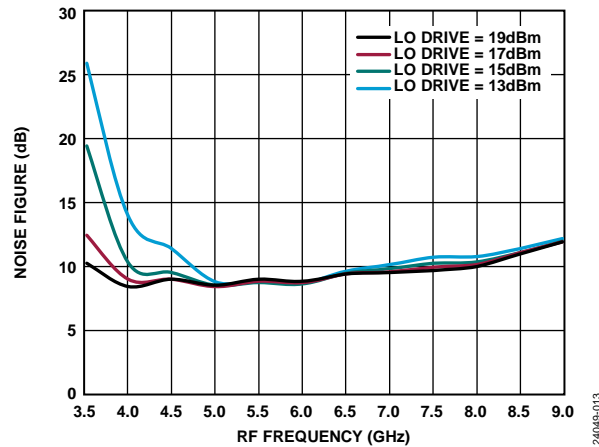

Figure 12. Noise Figure vs. RF Frequency at Various LO Drives,  $T_A = 25^\circ\text{C}$

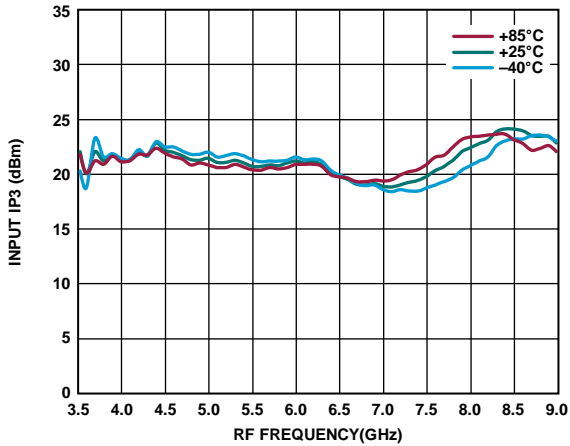

Figure 13. Input IP3 vs. RF Frequency at Various Temperatures, LO Drive = 15 dBm

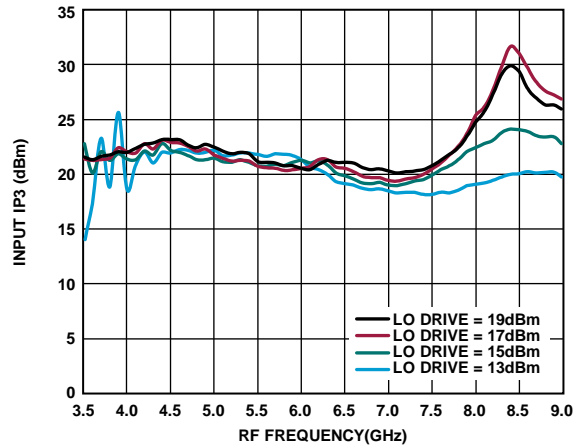

Figure 16. Input IP3 vs. RF Frequency at Various LO Drives,  $T_A = 25^\circ\text{C}$

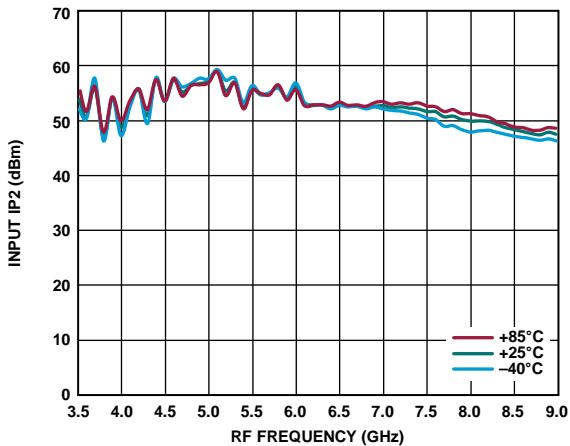

Figure 14. Input IP2 vs. RF Frequency at Various Temperatures, LO Drive = 15 dBm

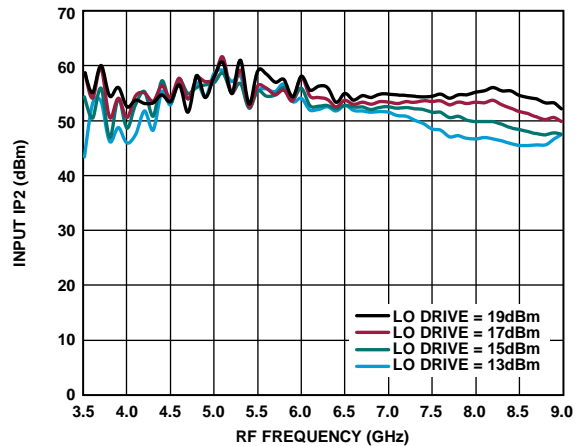

Figure 17. Input IP2 vs. RF Frequency at Various LO Drives,  $T_A = 25^\circ\text{C}$

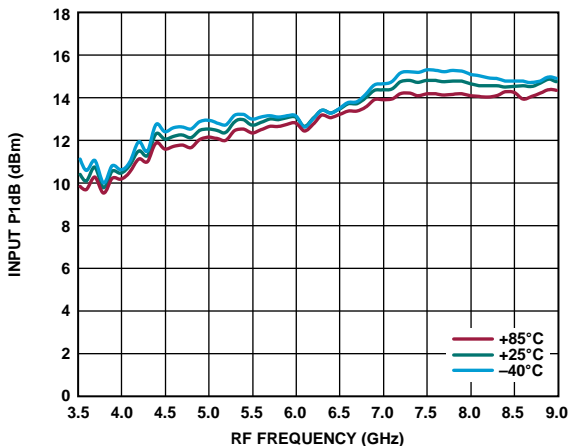

Figure 15. Input P1dB vs. RF Frequency at Various Temperatures, LO Drive = 15 dBm

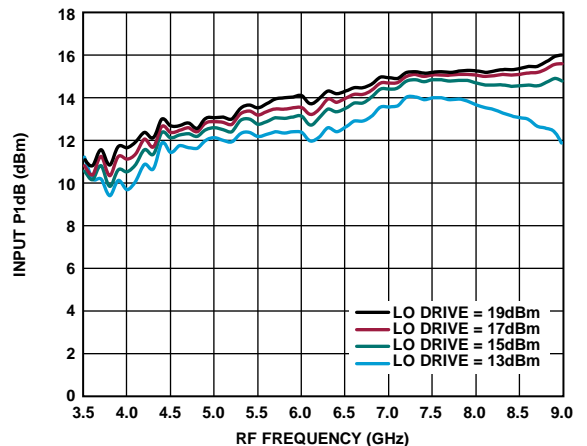

Figure 18. Input P1dB vs. RF Frequency at Various LO Drives,  $T_A = 25^\circ\text{C}$

IF = 100 MHz, Upper Sideband (Low-Side LO)

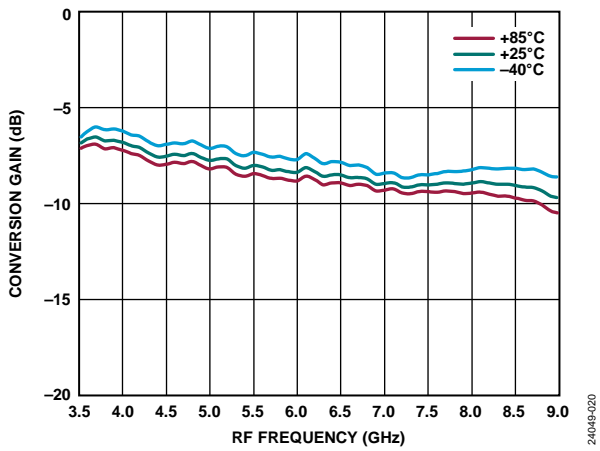

Figure 19. Conversion Gain vs. RF Frequency at Various Temperatures, LO Drive = 15 dBm

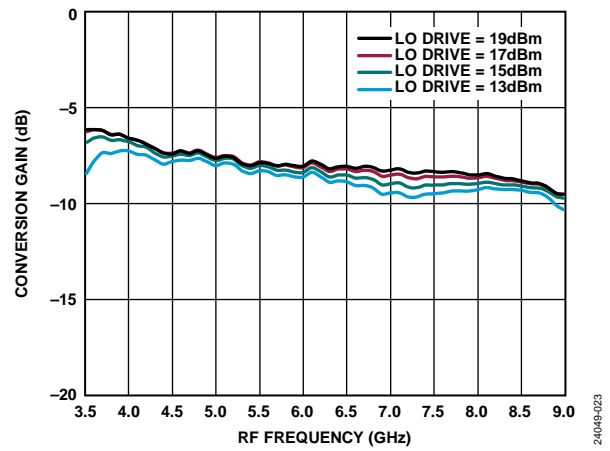

Figure 22. Conversion Gain vs. RF Frequency at Various LO Drives, TA = 25°C

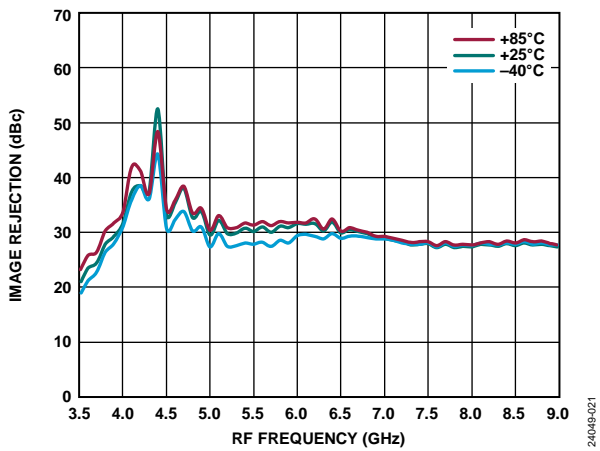

Figure 20. Image Rejection vs. RF Frequency at Various Temperatures, LO Drive = 15 dBm

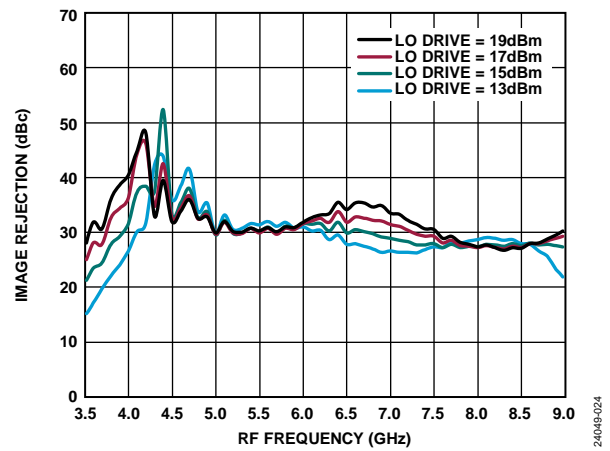

Figure 23. Image Rejection vs. RF Frequency at Various LO Drives, TA = 25°C

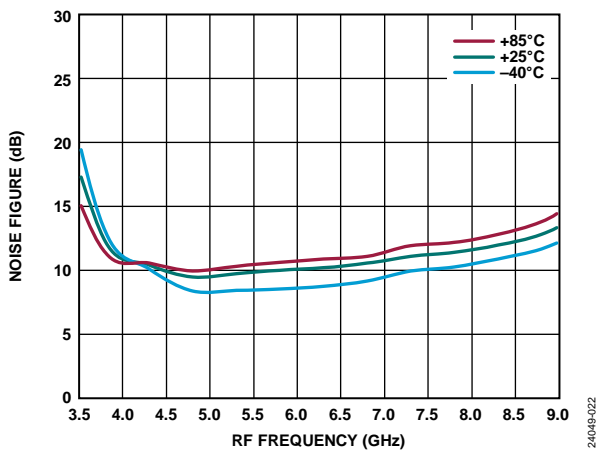

Figure 21. Noise Figure vs. RF Frequency at Various Temperatures, LO Drive = 15 dBm

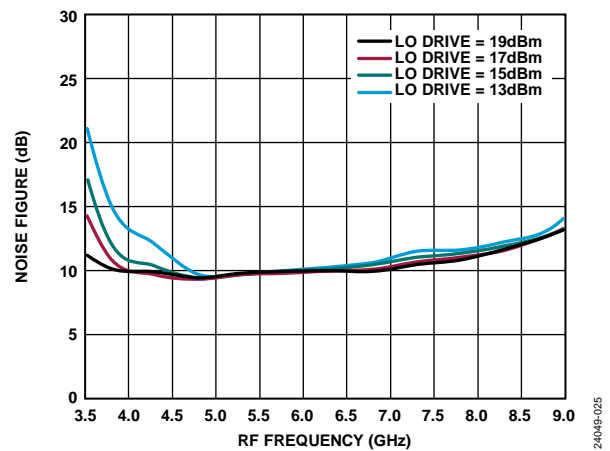

Figure 24. Noise Figure vs. RF Frequency at Various LO Drives, TA = 25°C



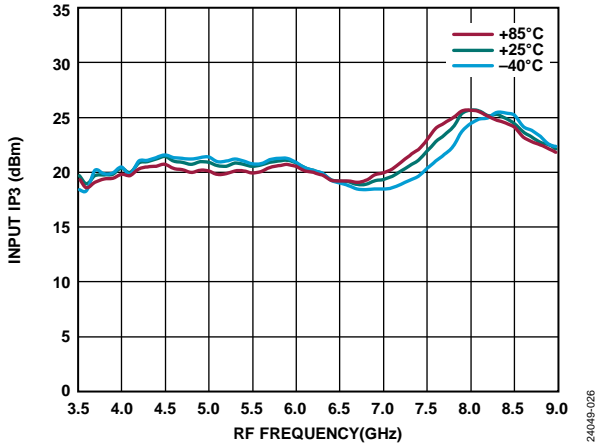

Figure 25. Input IP3 vs. RF Frequency at Various Temperatures, LO Drive = 15 dBm

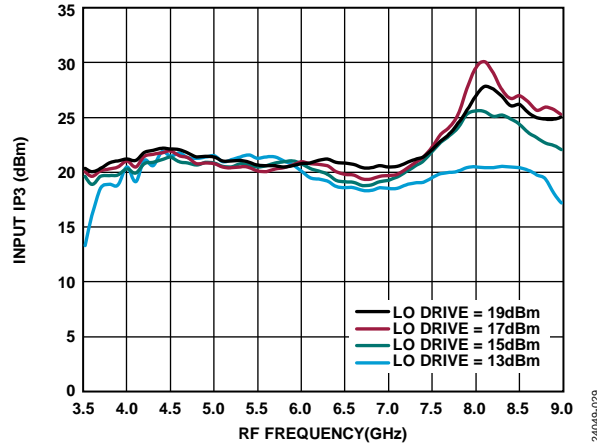

Figure 28. Input IP3 vs. RF Frequency at Various LO Drives,  $T_A = 25^\circ\text{C}$

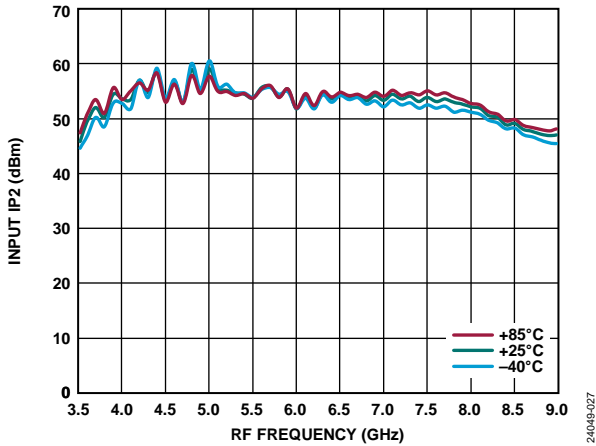

Figure 26. Input IP2 vs. RF Frequency at Various Temperatures, LO Drive = 15 dBm

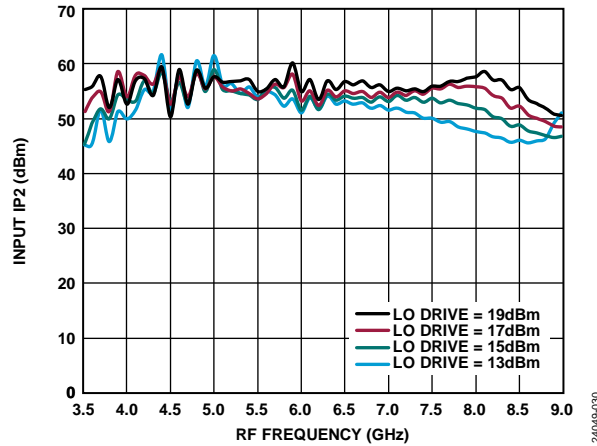

Figure 29. Input IP2 vs. RF Frequency at Various LO Drives,  $T_A = 25^\circ\text{C}$

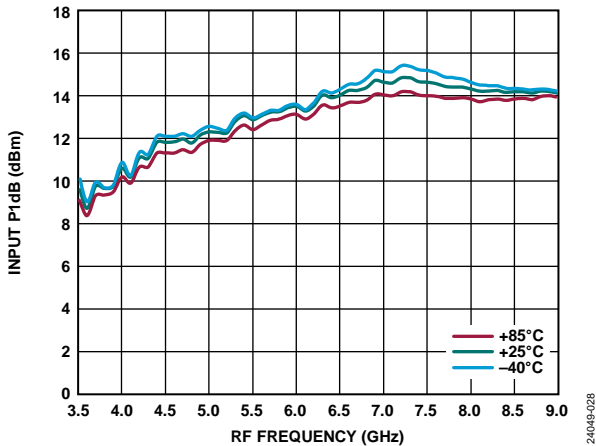

Figure 27. Input P1dB vs. RF Frequency at Various Temperatures, LO Drive = 15 dBm

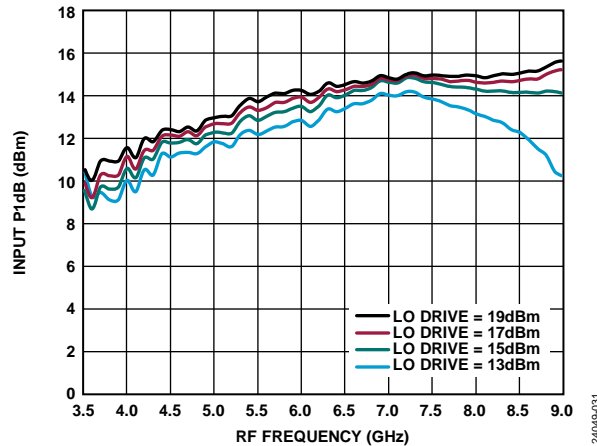

Figure 30. Input P1dB vs. RF Frequency at Various LO Drives,  $T_A = 25^\circ\text{C}$

**IF = 2500 MHz, Lower Sideband (High-Side LO)**

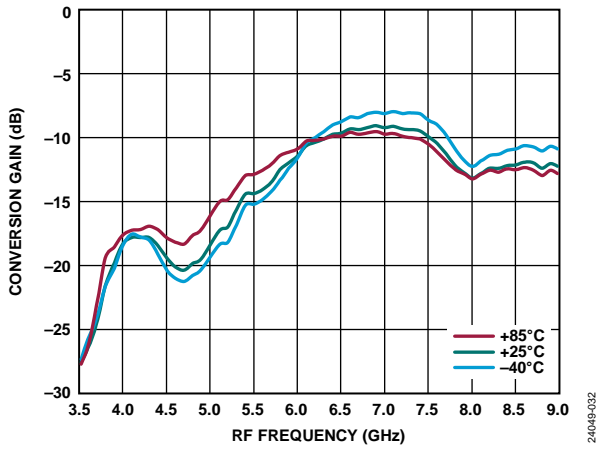

Figure 31. Conversion Gain vs. RF Frequency at Various Temperatures, LO Drive = 15 dBm

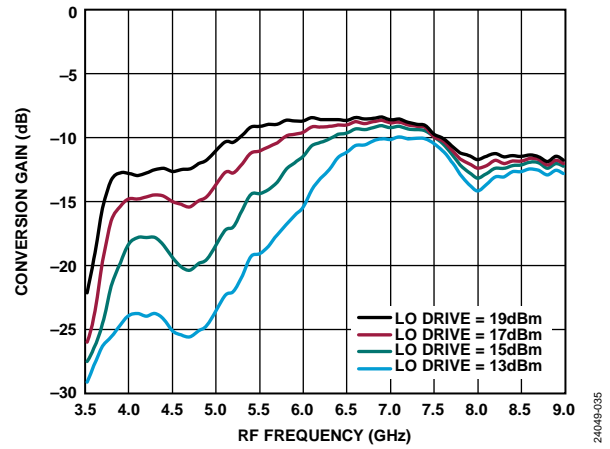

Figure 34. Conversion Gain vs. RF Frequency at Various LO Drives,  $T_A = 25^\circ\text{C}$

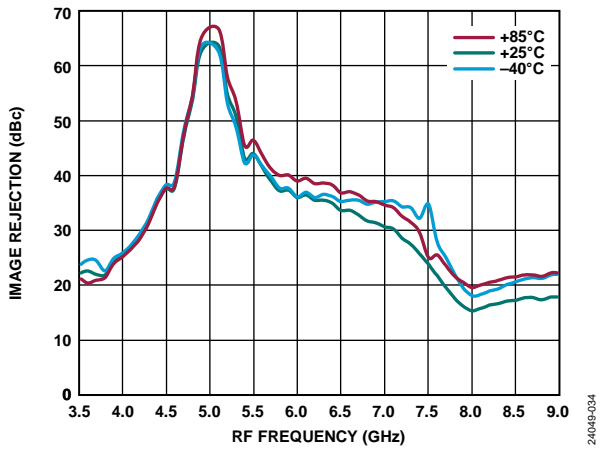

Figure 32. Image Rejection vs. RF Frequency at Various Temperatures, LO Drive = 15 dBm

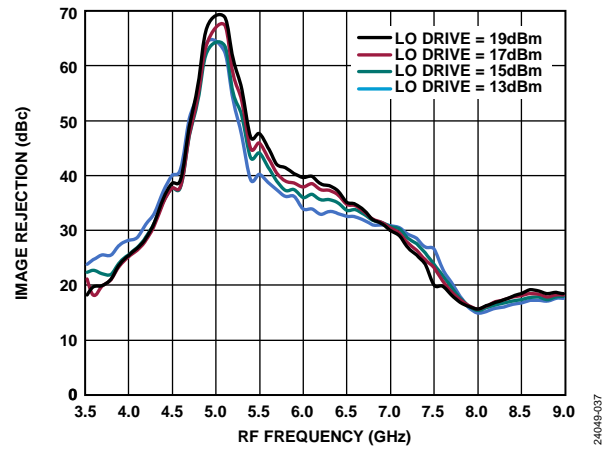

Figure 35. Image Rejection vs. RF Frequency at Various LO Drives,  $T_A = 25^\circ\text{C}$

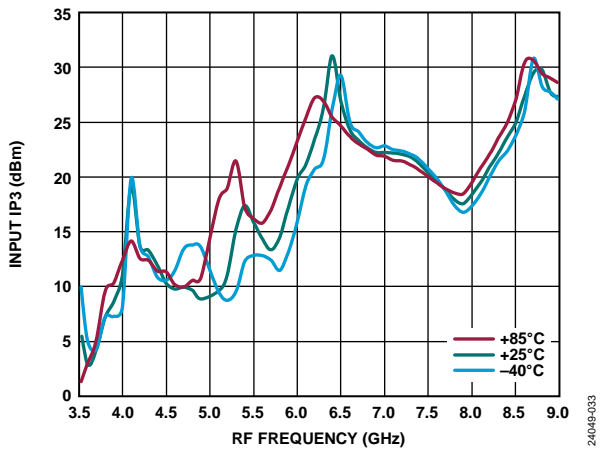

Figure 33. Input IP3 vs. RF Frequency at Various Temperatures, LO Drive = 15 dBm

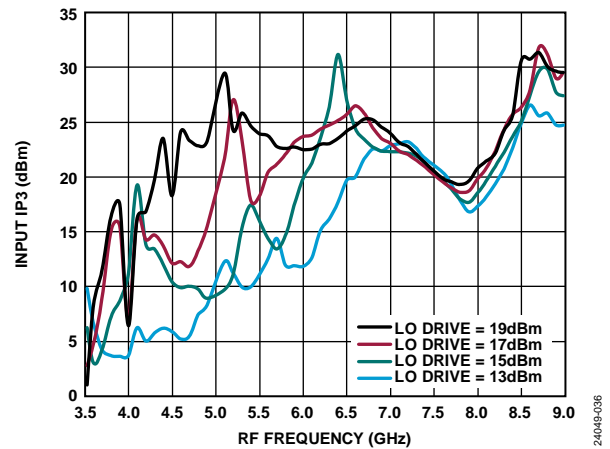

Figure 36. Input IP3 vs. RF Frequency at Various LO Drives,  $T_A = 25^\circ\text{C}$

**IF = 2500 MHz, Lower Sideband (High-Side LO)**

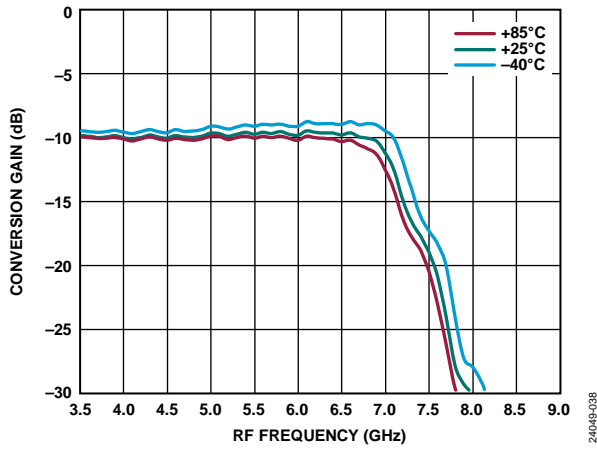

Figure 37. Conversion Gain vs. RF Frequency at Various Temperatures, LO Drive = 15 dBm

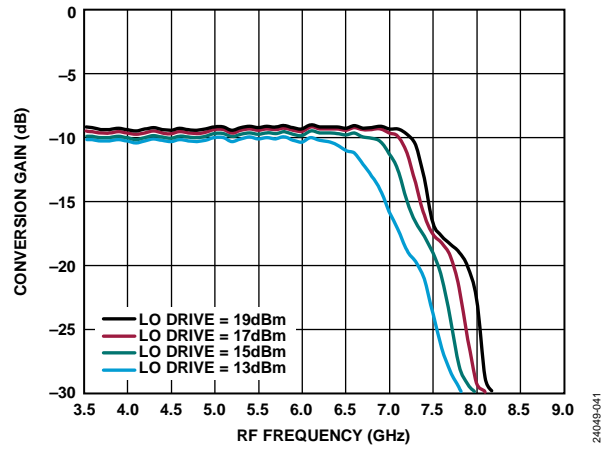

Figure 40. Conversion Gain vs. RF Frequency at Various LO Drives,  $T_A = 25^\circ\text{C}$

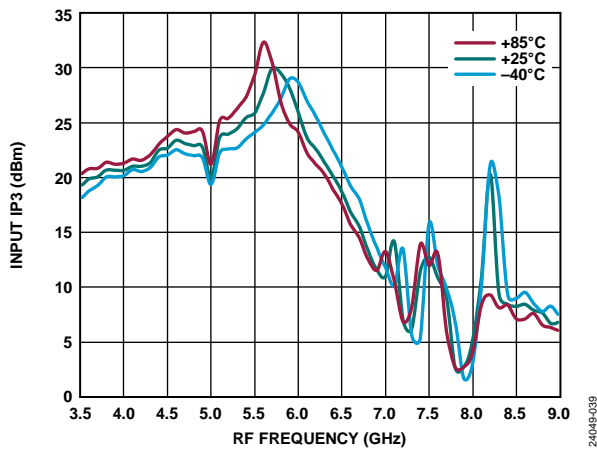

Figure 38. Input IP3 vs. RF Frequency at Various Temperatures, LO Drive = 15 dBm

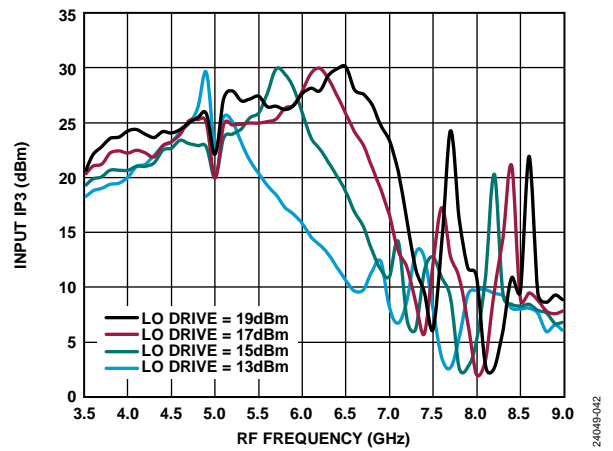

Figure 41. Input IP3 vs. RF Frequency at Various LO Drives,  $T_A = 25^\circ\text{C}$

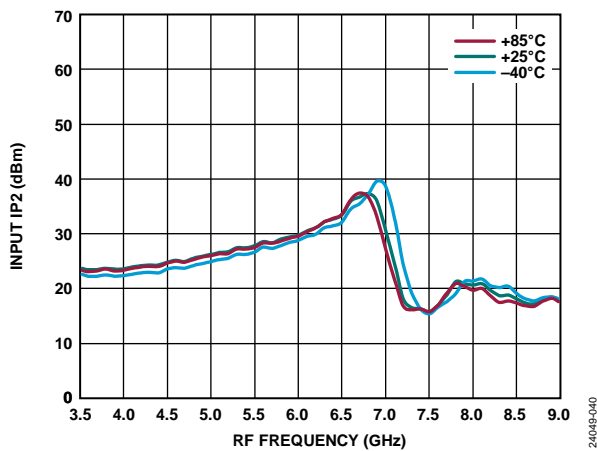

Figure 39. Input IP2 vs. RF Frequency at Various Temperatures, LO Drive = 15 dBm

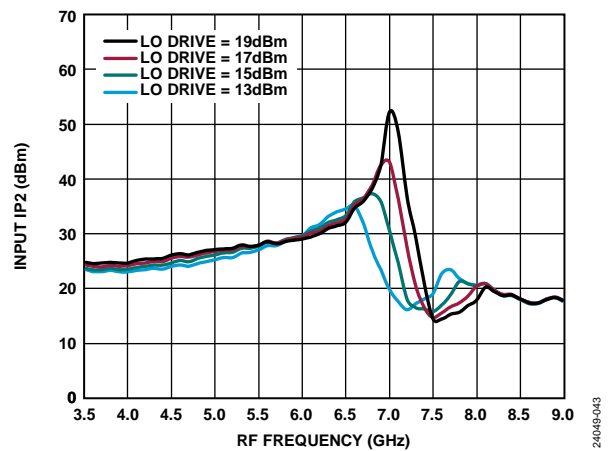

Figure 42. Input IP2 vs. RF Frequency at Various LO Drives,  $T_A = 25^\circ\text{C}$

## LO = 8 GHz Lower Sideband

Data taken as image reject mixer with external 90° hybrid at the IFx ports.

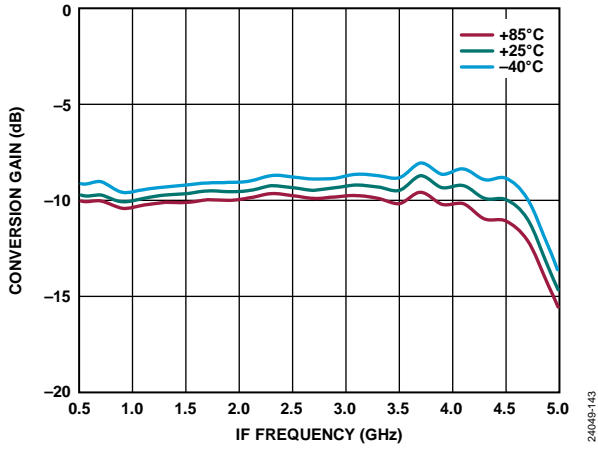

Figure 43. Conversion Gain vs. IF Frequency at Various Temperatures, LO Drive = 15 dBm

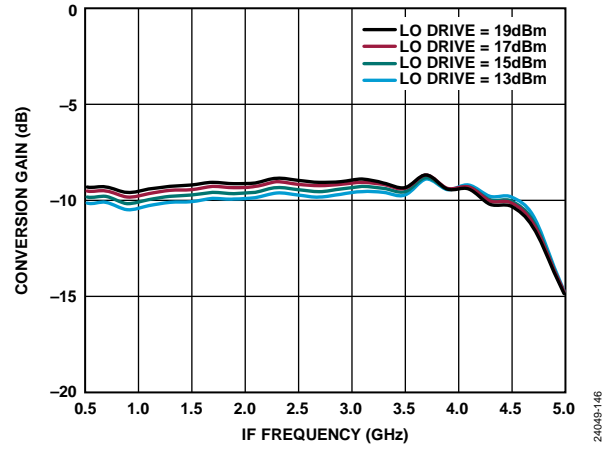

Figure 46. Conversion Gain vs. IF Frequency at Various LO Drives,  $T_A = 25^\circ\text{C}$

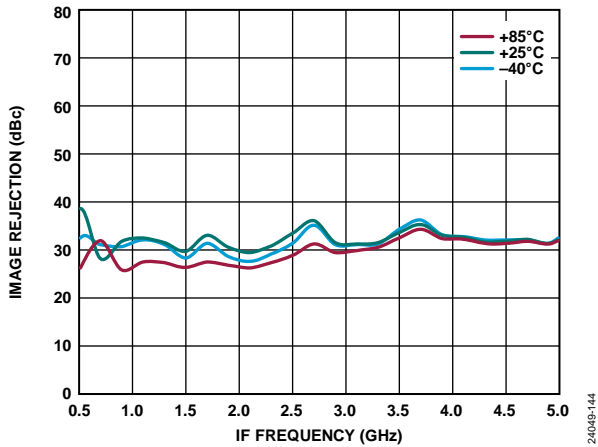

Figure 44. Image Rejection vs. IF Frequency at Various Temperatures, LO Drive = 15 dBm

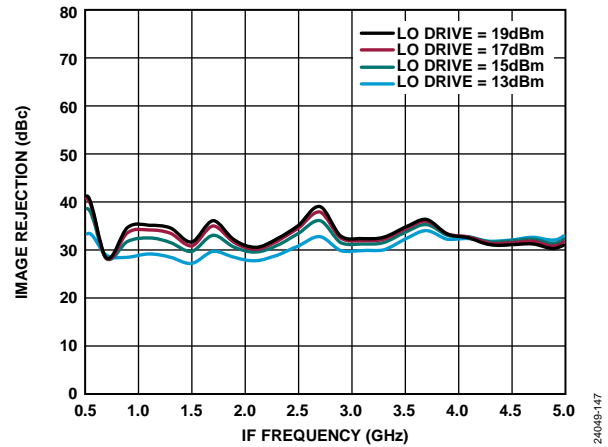

Figure 47. Image Rejection vs. IF Frequency at Various LO Drives,  $T_A = 25^\circ\text{C}$

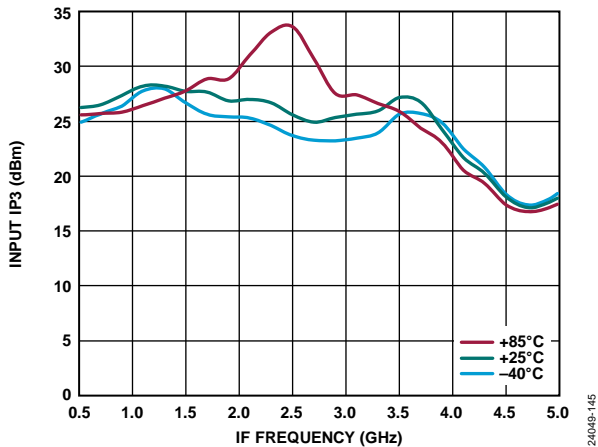

Figure 45. Input IP3 vs. IF Frequency at Various Temperatures, LO Drive = 15 dBm

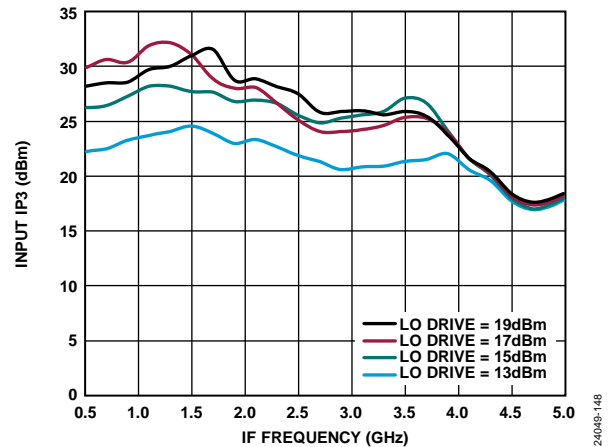

Figure 48. Input IP3 vs. IF Frequency at Various LO Drives,  $T_A = 25^\circ\text{C}$

Phase and Amplitude Balance—Upper Sideband, IF = 100 MHz

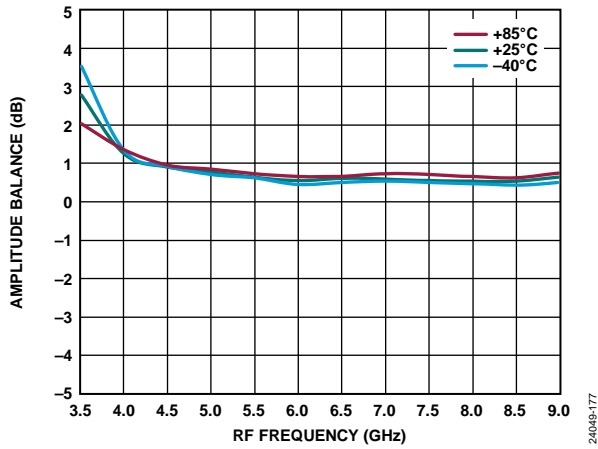

Figure 49. Amplitude Balance vs. RF Frequency at Various Temperatures, LO = 15 dBm

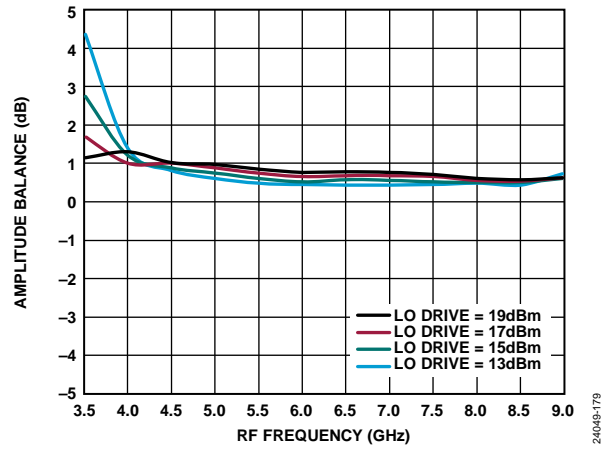

Figure 51. Amplitude Balance vs. RF Frequency at Various LO Power Levels,  $T_A = 25^\circ\text{C}$

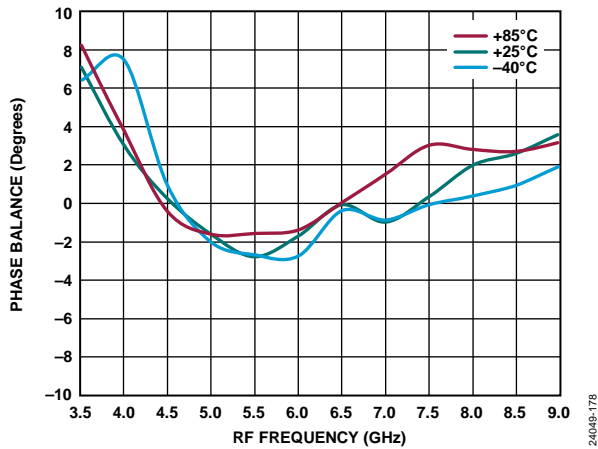

Figure 50. Phase Balance vs. RF Frequency at Various Temperatures, LO = 15 dBm

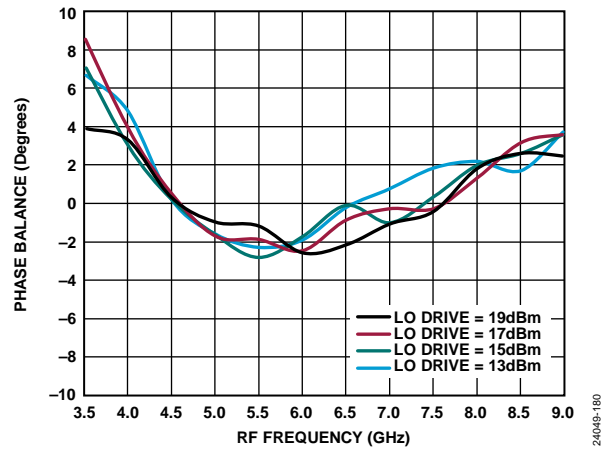

Figure 52. Phase Balance vs. RF Frequency at Various LO Power Levels,  $T_A = 25^\circ\text{C}$

Phase and Amplitude Balance—Lower Sideband, IF = 100 MHz

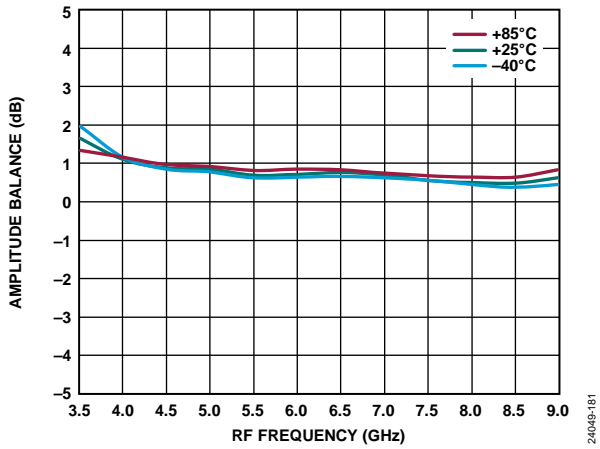

Figure 53. Amplitude Balance vs. RF Frequency at Various Temperatures, LO = 15 dBm

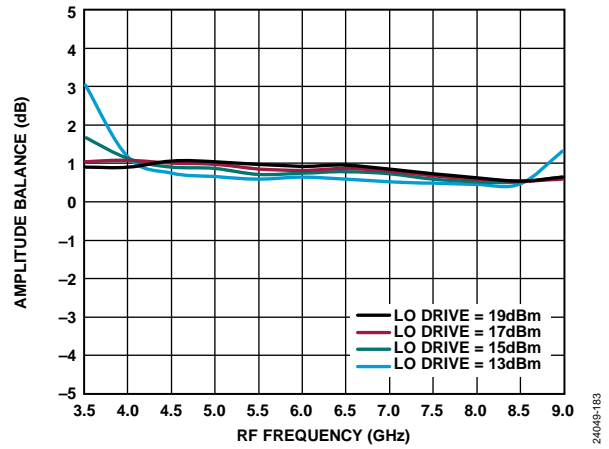

Figure 55. Amplitude Balance vs. RF Frequency at Various LO Power Levels,  $T_A = 25^\circ\text{C}$

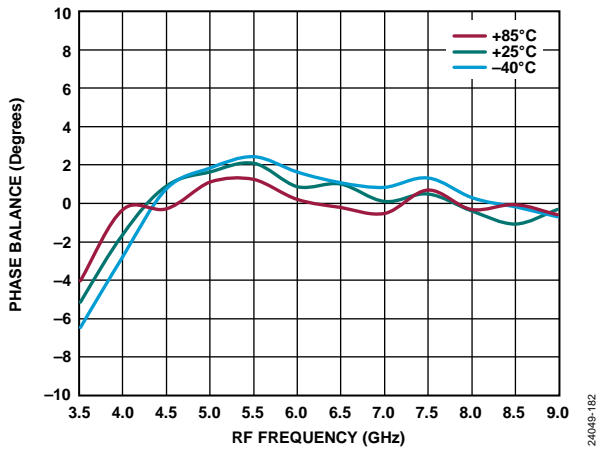

Figure 54. Phase Balance vs. RF Frequency at Various Temperatures, LO = 15 dBm

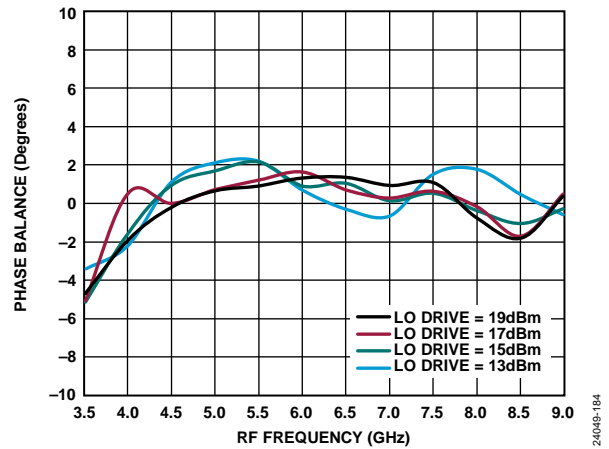

Figure 56. Phase Balance vs. RF Frequency at Various LO Power Levels,  $T_A = 25^\circ\text{C}$

Isolation and Return Loss—IF = 100 MHz, Upper Sideband (Low-Side LO)

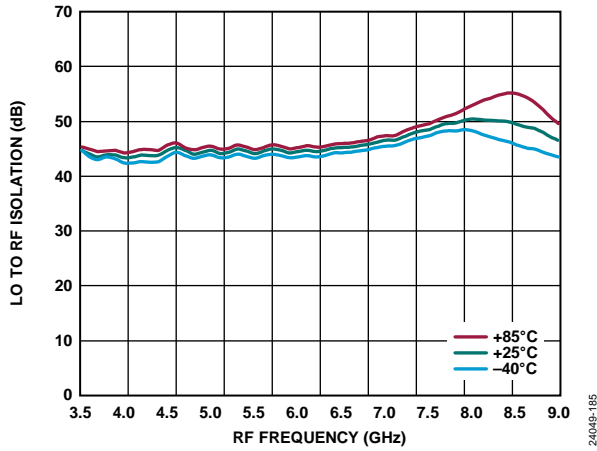

Figure 57. LO to RF Isolation vs. RF Frequency at Various Temperatures, LO Drive = 15 dBm

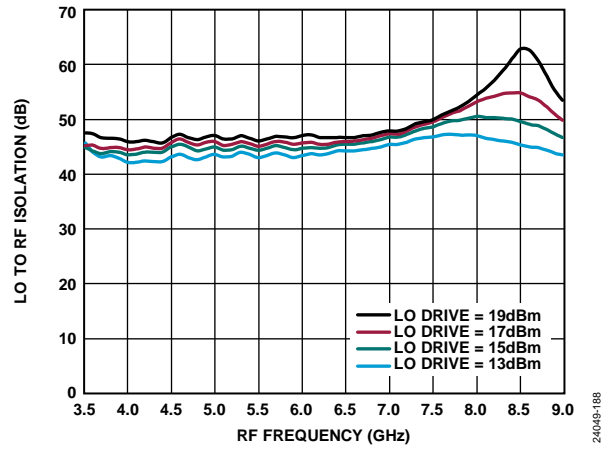

Figure 60. LO to RF Isolation vs. RF Frequency at Various Power Levels,  $T_A = 25^\circ\text{C}$

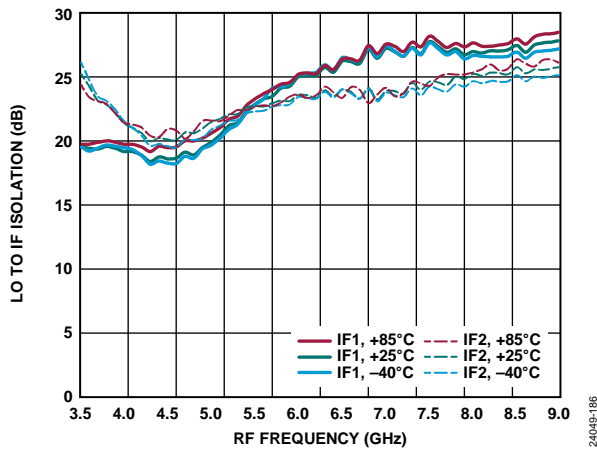

Figure 58. LO to IF Isolation vs. RF Frequency at Various Temperatures and IF1 and IF2, LO Drive = 15 dBm

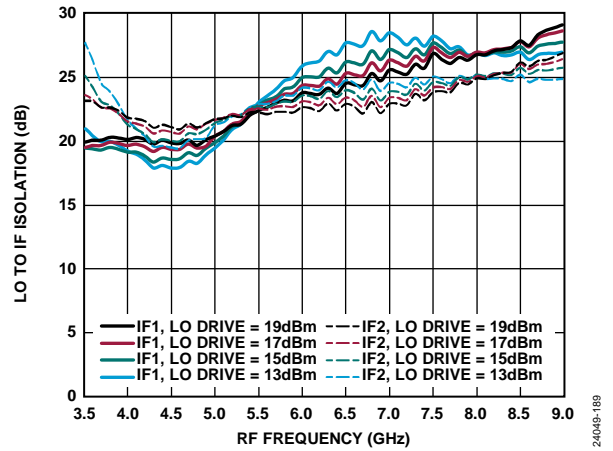

Figure 61. LO to IF Isolation vs. RF Frequency at Various Power Levels and IF1 and IF2,  $T_A = 25^\circ\text{C}$

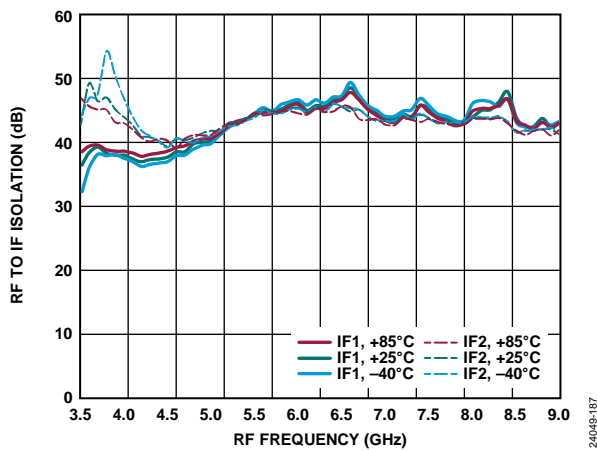

Figure 59. RF to IF Isolation vs. RF Frequency at Various Temperatures and IF1 and IF2, LO Drive = 15 dBm

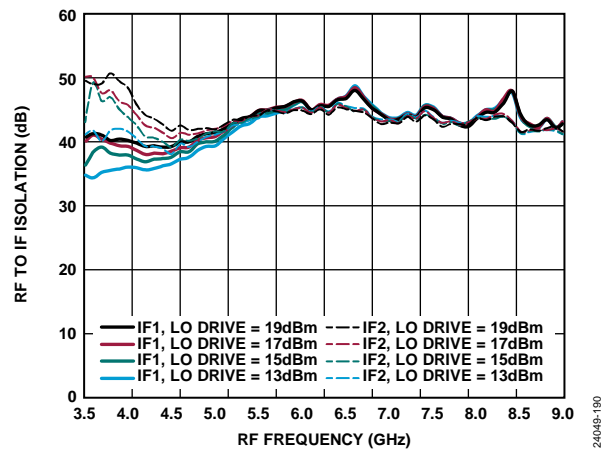

Figure 62. RF to IF Isolation vs. RF Frequency at Various Power Levels and IF1 and IF2,  $T_A = 25^\circ\text{C}$

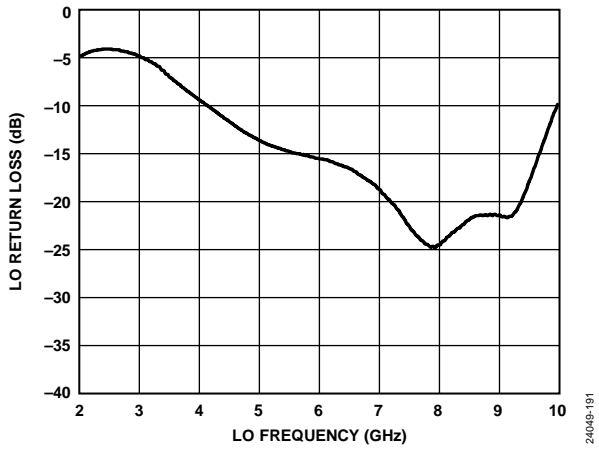

Figure 63. LO Return Loss vs. LO Frequency at LO = 15 dBm,  $T_A = 25^\circ\text{C}$

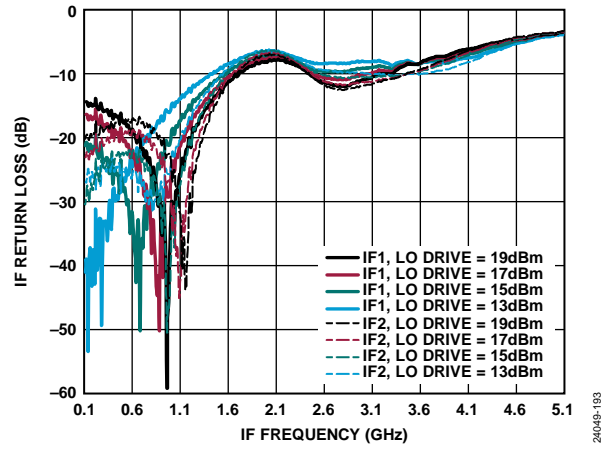

Figure 65. IF Return Loss vs. IF Frequency at Various Power Levels and IF1 and IF2, LO = 5 GHz,  $T_A = 25^\circ\text{C}$

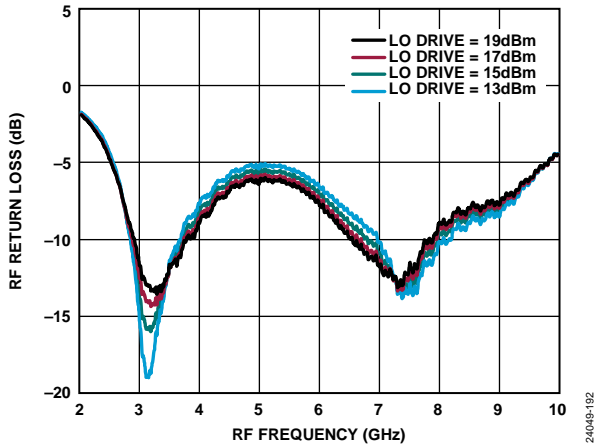

Figure 64. RF Return Loss vs. RF Frequency at Various LO Power Levels, LO = 5 GHz,  $T_A = 25^\circ\text{C}$



**IF Bandwidth—LO = 5 GHz Upper Side Band**

Data taken as image reject mixer with external 90° hybrid at the IFx ports.

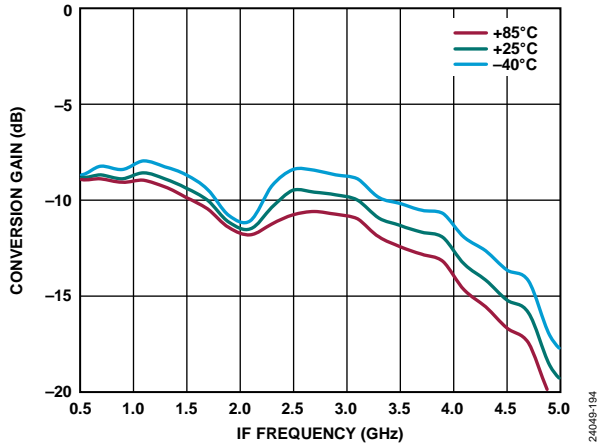

Figure 66. Conversion Gain vs. IF Frequency at Various Temperatures, LO Drive = 15 dBm

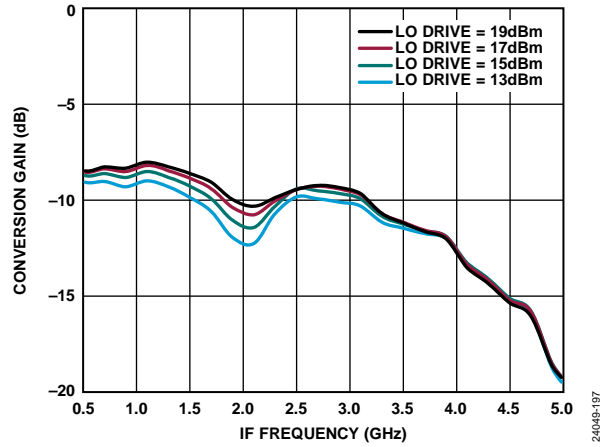

Figure 69. Conversion Gain vs. IF Frequency at Various LO Drives,  $T_A = 25^\circ\text{C}$

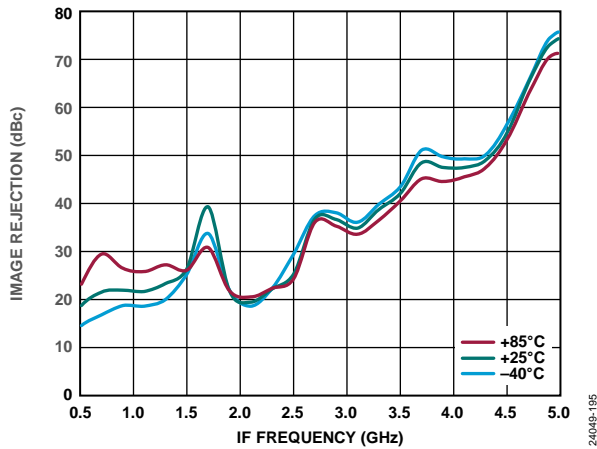

Figure 67. Image Rejection vs. IF Frequency at Various Temperatures, LO Drive = 15 dBm

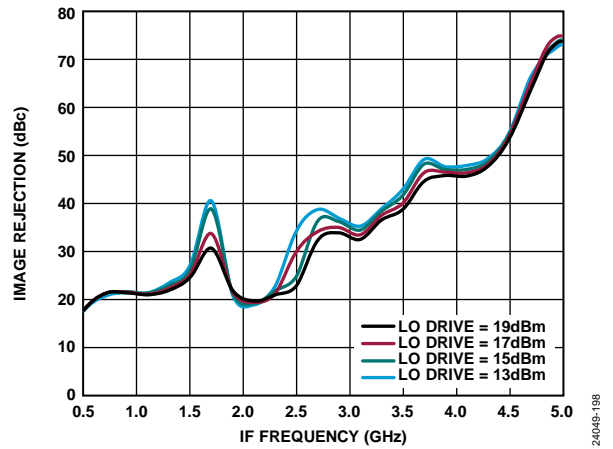

Figure 70. Image Rejection vs. IF Frequency at Various LO Drives,  $T_A = 25^\circ\text{C}$

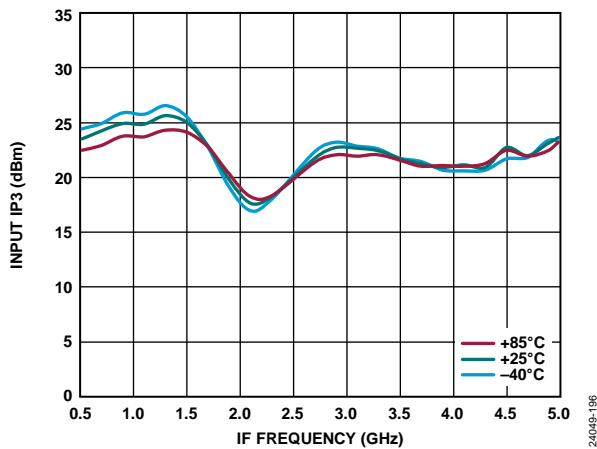

Figure 68. Input IP3 vs. IF Frequency at Various Temperatures, LO Drive = 15 dBm

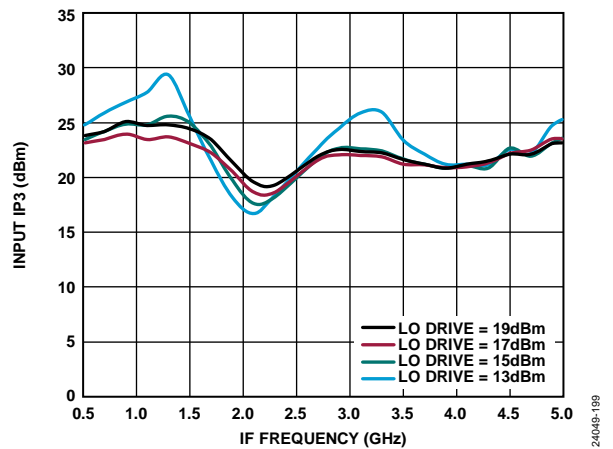

Figure 71. Input IP3 vs. IF Frequency at Various LO Drives,  $T_A = 25^\circ\text{C}$

**UPCONVERTER PERFORMANCE**

**Input IF ( $IF_{IN}$ ) = 100 MHz, Upper Side Band (Low-Side LO)**

Data taken as single sideband upconverter with external 90° hybrid at the IFx ports.

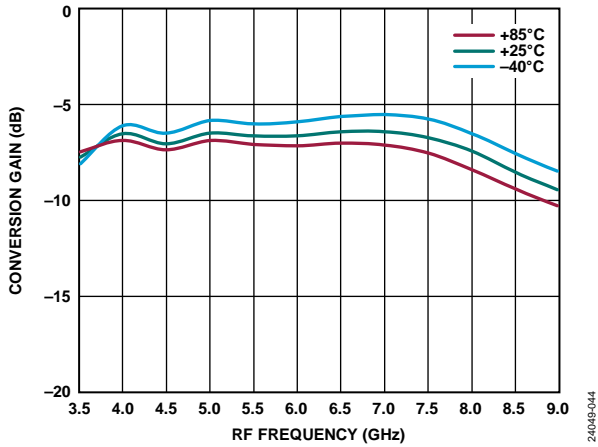

Figure 72. Conversion Gain vs. RF Frequency at Various Temperatures, LO Drive = 15 dBm

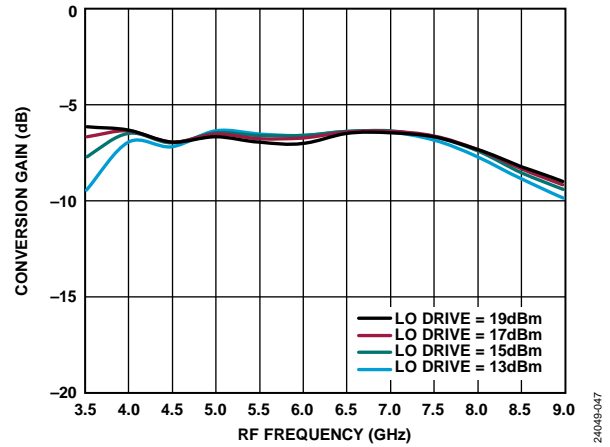

Figure 75. Conversion Gain vs. RF Frequency at Various LO Drives,  $T_A = 25^\circ\text{C}$

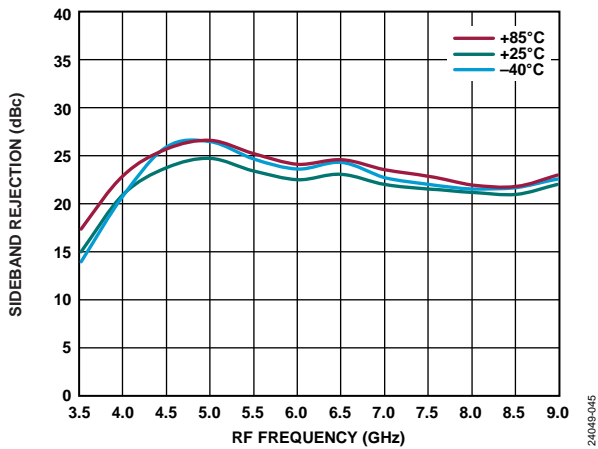

Figure 73. Sideband Rejection vs. RF Frequency at Various Temperatures, LO Drive = 15 dBm

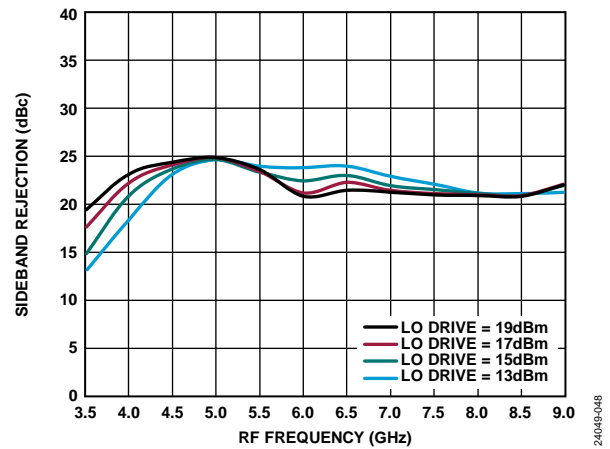

Figure 76. Sideband vs. RF Frequency at Various LO Drives,  $T_A = 25^\circ\text{C}$

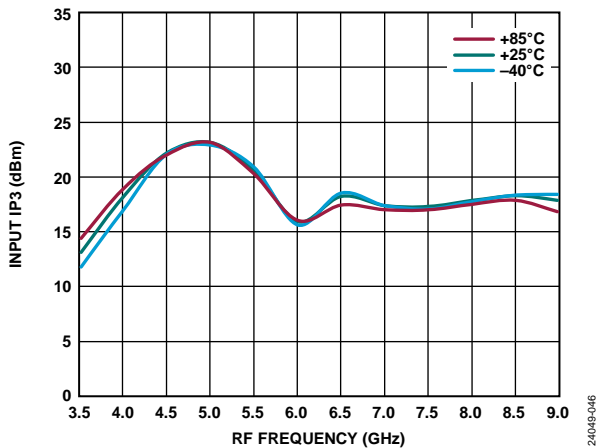

Figure 74. Input IP3 vs. RF Frequency at Various Temperatures, LO Drive = 15 dBm

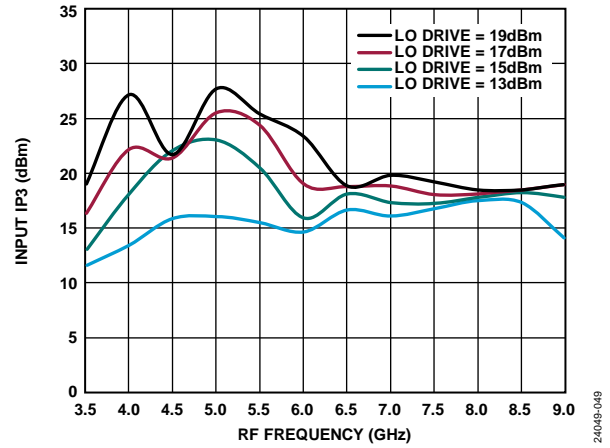

Figure 77. Input IP3 vs. RF Frequency at Various LO Drives,  $T_A = 25^\circ\text{C}$

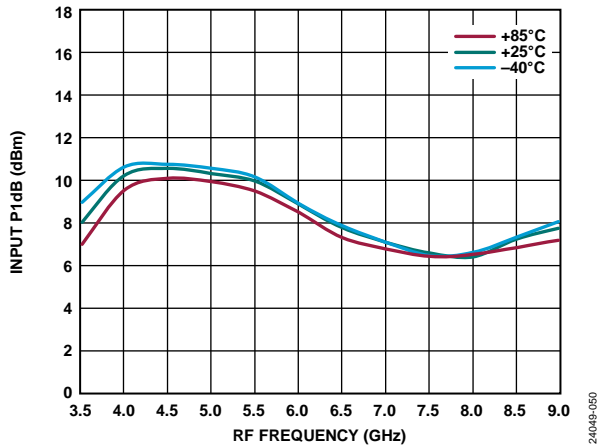

Figure 78. Input P1dB vs. RF Frequency at Various Temperatures, LO Drive = 15 dBm

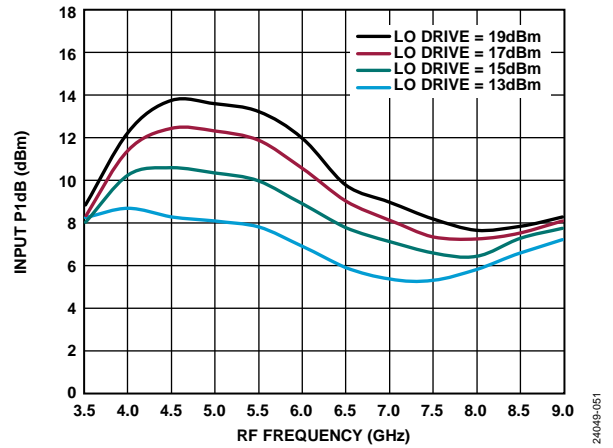

Figure 79. Input P1dB vs. RF Frequency at Various LO Drives, TA = 25°C

## $IF_{IN} = 100 \text{ MHz}$ , Lower Side Band (High-Side LO)

Data taken as single sideband upconverter with external  $90^\circ$  hybrid at the IFx ports.

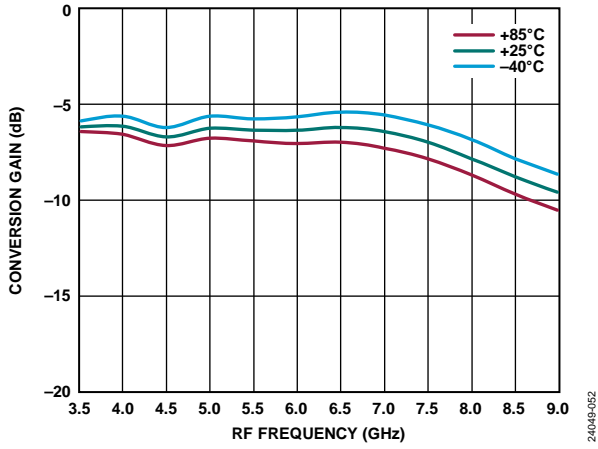

Figure 80. Conversion Gain vs. RF Frequency at Various Temperatures, LO Drive = 15 dBm

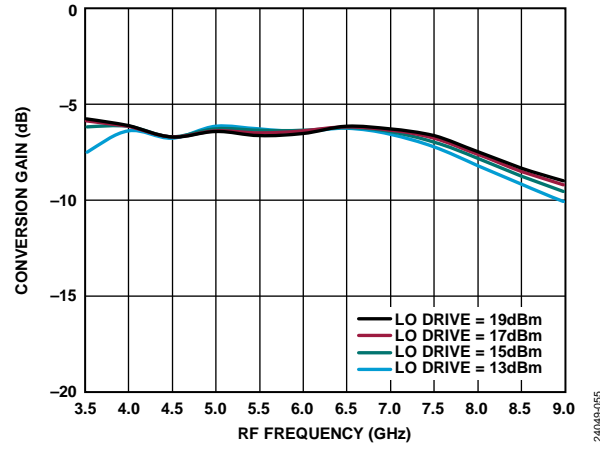

Figure 83. Conversion Gain vs. RF Frequency at Various LO Drives,  $T_A = 25^\circ\text{C}$

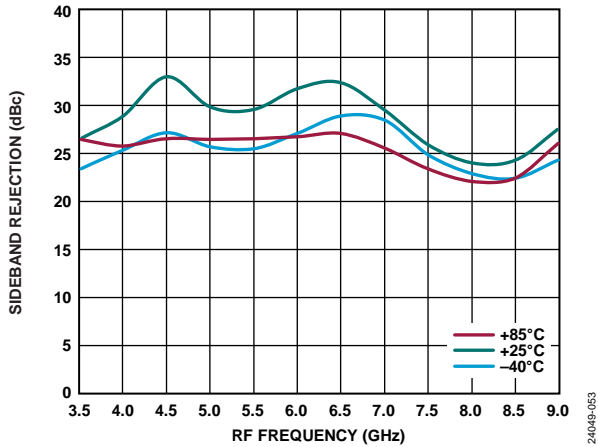

Figure 81. Sideband Rejection vs. RF Frequency at Various Temperatures, LO Drive = 15 dBm

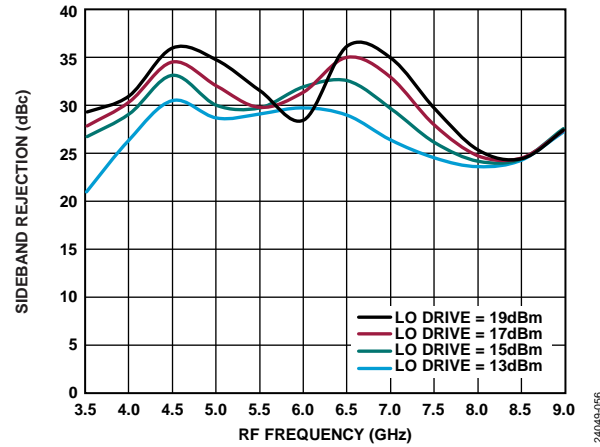

Figure 84. Sideband Rejection vs. RF Frequency at Various LO Drives,  $T_A = 25^\circ\text{C}$

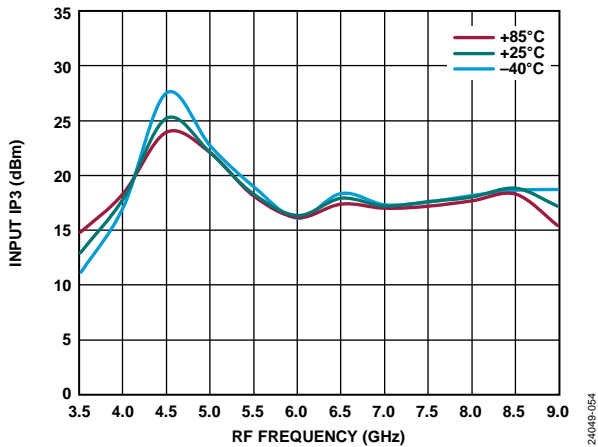

Figure 82. Input IP3 vs. RF Frequency at Various Temperatures, LO Drive = 15 dBm

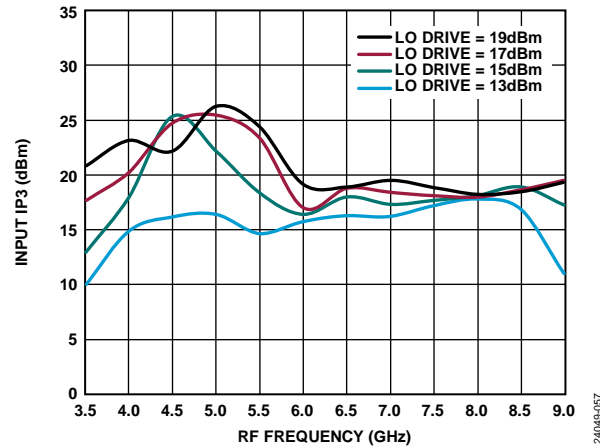

Figure 85. Input IP3 vs. RF Frequency at Various LO Drives,  $T_A = 25^\circ\text{C}$

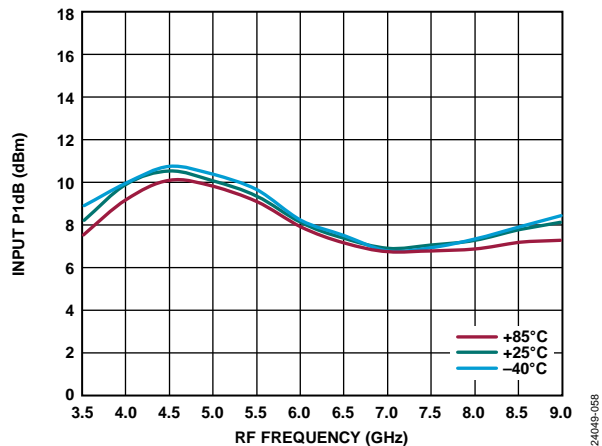

Figure 86. Input P1dB vs. RF Frequency at Various Temperatures, LO Drive = 15 dBm

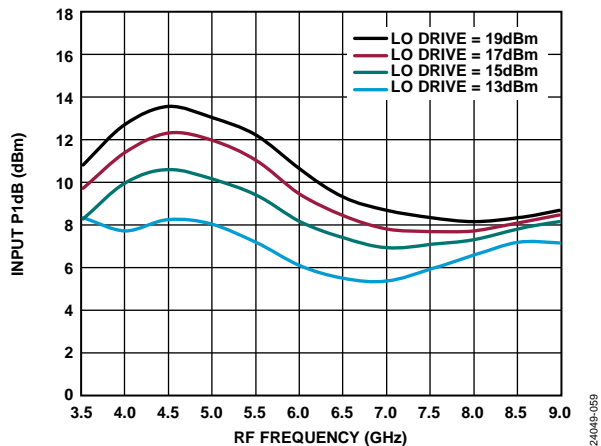

Figure 87. Input P1dB vs. RF Frequency at Various LO Drives, TA = 25°C

## $IF_{IN} = 2500$ MHz, Upper Side Band (Low-Side LO)

Data taken as single sideband upconverter with external 90° hybrid at the IFx ports.

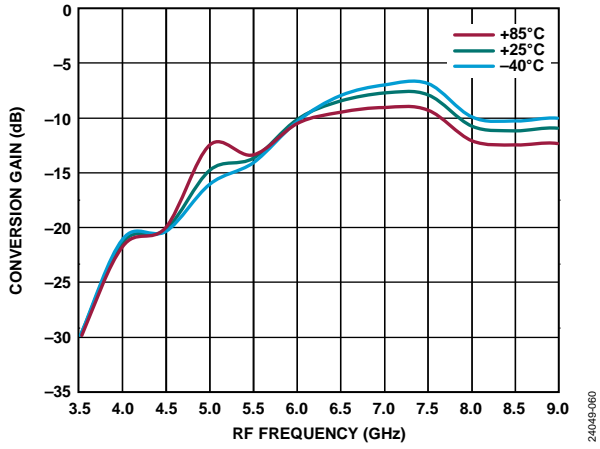

Figure 88. Conversion Gain vs. RF Frequency at Various Temperatures, LO Drive = 15 dBm

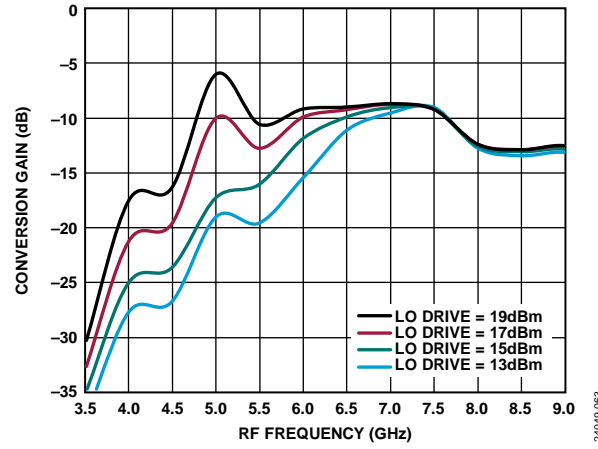

Figure 91. Conversion Gain vs. RF Frequency at Various LO Drives,  $T_A = 25^\circ\text{C}$

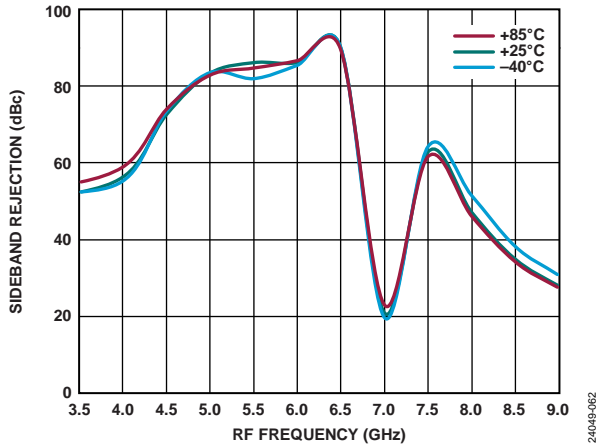

Figure 89. Sideband Rejection vs. RF Frequency at Various Temperatures, LO Drive = 15 dBm

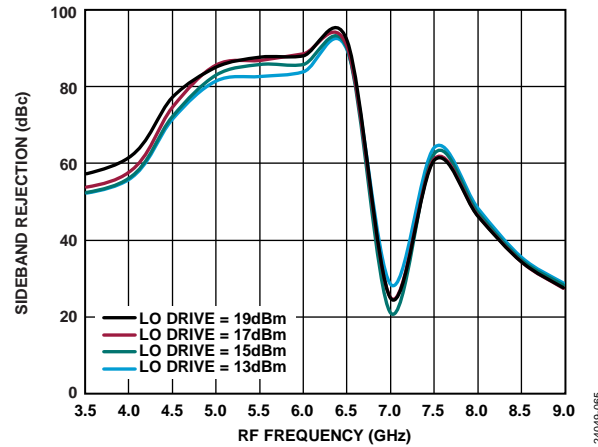

Figure 92. Sideband Rejection vs. RF Frequency at Various LO Drives,  $T_A = 25^\circ\text{C}$

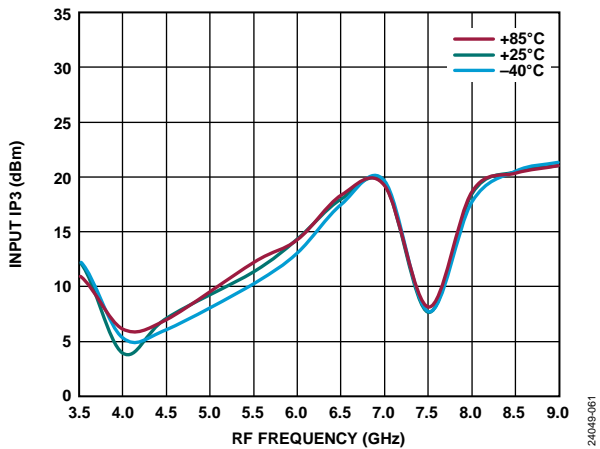

Figure 90. Input IP3 vs. RF Frequency at Various Temperatures, LO Drive = 15 dBm

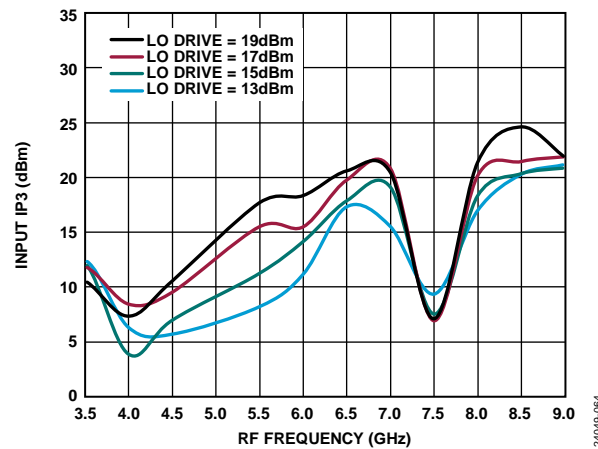

Figure 93. Input IP3 vs. RF Frequency at Various LO Drives,  $T_A = 25^\circ\text{C}$

**$IF_{IN} = 2500$  MHz, Lower Side Band (High-Side LO)**

Data taken as single sideband upconverter with external 90° hybrid at the IFx ports.

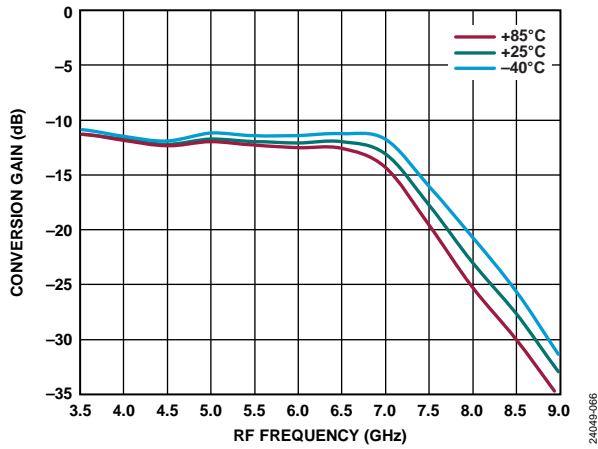

Figure 94. Conversion Gain vs. RF Frequency at Various Temperatures, LO Drive = 15 dBm

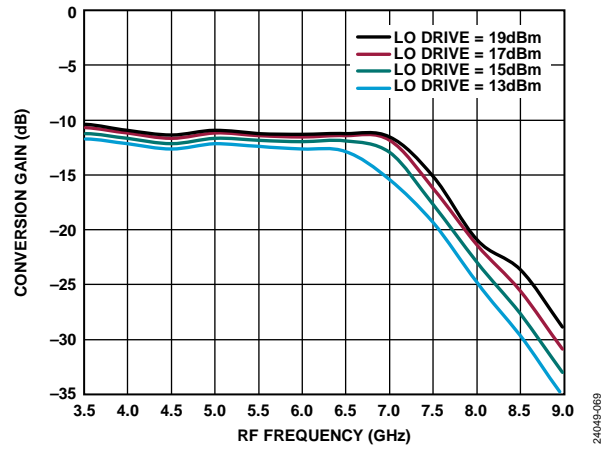

Figure 97. Conversion Gain vs. RF Frequency at Various LO Drives,  $T_A = 25^\circ\text{C}$

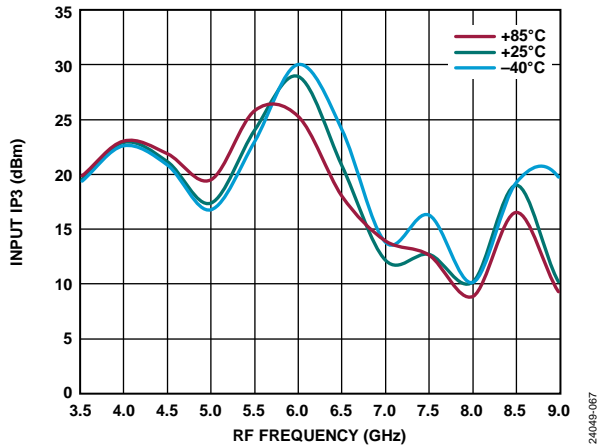

Figure 95. Input IP3 vs. RF Frequency at Various Temperatures, LO Drive = 15 dBm

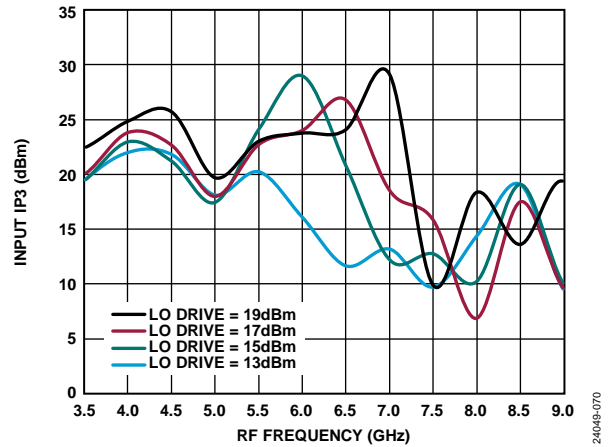

Figure 98. Input IP3 vs. RF Frequency at Various LO Drives,  $T_A = 25^\circ\text{C}$

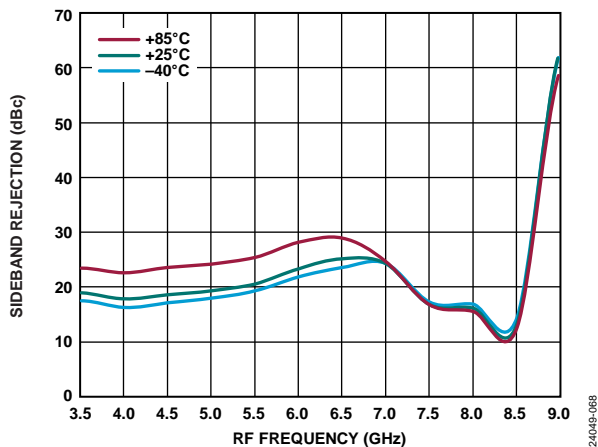

Figure 96. Sideband Rejection vs. RF Frequency at Various Temperatures, LO Drive = 15 dBm

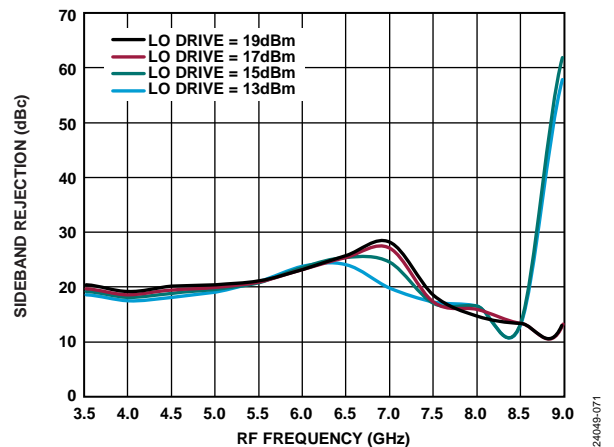

Figure 99. Sideband Rejection vs. RF Frequency at Various LO Drives,  $T_A = 25^\circ\text{C}$

**SPURIOUS AND HARMONICS PERFORMANCE**

**LO Harmonics Isolation**

LO power = 15 dBm, T<sub>A</sub> = 25°C, and all values are in dBc below the input LO level measured at the RF port.

**Table 5. N × LO Spur at RF Output**

LO Frequency (GHz)	N × LO Spur at RF Port			
	1	2	3	4
2.5	65	44	71	58
3.5	45	57	53	61
4.5	46	42	48	54
5.5	44	62	60	>95
6.5	45	76	65	>95
7.5	48	84	>95	>95

LO power = 15 dBm, T<sub>A</sub> = 25°C, and all values are in dBc below the input LO level measured at the IFx port.

**Table 6. N × LO Spur at IF Output**

LO Frequency (GHz)	N × LO Spur at IFx Port			
	1	2	3	4
2.5	24	52	58	78
3.5	19	56	55	78
4.5	19	61	56	87
5.5	23	74	61	>95
6.5	26	74	53	>95
7.5	27	72	>95	>95

**Downconverter M × N Spurious Outputs**

Mixer spurious products are measured in dBc from the IF output power level, unless otherwise specified. Spur values are (M × RF) – (N × LO). N/A means not applicable.

IF = 100 MHz, RF = 5600 MHz, LO = 5500 MHz, RF power = –10 dBm, LO power = +15 dBm, and T<sub>A</sub> = 25°C.

M × RF	N × LO					
	0	1	2	3	4	5
0	N/A	6	73	22	37	57
1	39	0	46	73	73	66
2	76	65	72	62	72	73
3	71	76	85	92	84	69
4	67	72	77	87	96	86
5	56	62	73	78	86	94

IF = 100 MHz, RF = 7400 MHz, LO = 7500 MHz, RF power = –10 dBm, LO power = +15 dBm, and T<sub>A</sub> = 25°C.

M × RF	N × LO					
	0	1	2	3	4	5
0	N/A	–9	+70	+10	+26	+50
1	+37	0	+50	+68	+64	+50
2	+70	+63	+75	+64	+70	+63
3	+58	+71	+83	+91	+83	+71
4	+58	+60	+70	+86	+95	+83
5	+49	+58	+61	+70	+86	+94

**Upconverter M × N Spurious Outputs**

Mixer spurious products are measured in dBc from the RF output power level, unless otherwise specified. Spur values are (M × IF<sub>IN</sub>) + (N × LO). N/A means not applicable.

IF<sub>IN</sub> = 100 MHz, RF = 5600 MHz, LO = 5500 MHz, RF power = –10 dBm, LO power = 15 dBm, and T<sub>A</sub> = 25°C.

M × IF <sub>IN</sub>	N × LO					
	0	1	2	3	4	5
+5	57	62	50	0	0	0
+4	68	56	63	48	0	0
+3	72	66	58	64	49	0
+2	76	71	66	56	64	46
+1	39	75	72	67	53	63
0	N/A	6	73	22	37	57
–1	39	0	46	73	73	66
–2	76	65	72	62	72	73
–3	71	76	85	92	84	69
–4	67	72	77	87	96	86
–5	56	62	73	78	86	94

IF = 100 MHz, RF = 7400 MHz, LO = 7500 GHz, RF power = –10 dBm, LO power = 15 dBm, and T<sub>A</sub> = 25°C.

M × IF <sub>IN</sub>	N × LO					
	0	1	2	3	4	5
+5	98	83	86	83	79	73
+4	100	86	85	82	77	74
+3	99	51	85	82	78	72
+2	97	50	85	82	76	80
+1	96	3	86	26	50	73
0	N/A	18	52	30	15	72
–1	98	0	85	31	50	74
–2	99	49	87	81	80	73
–3	98	51	87	82	79	73
–4	98	80	84	82	78	74
–5	98	84	85	81	78	72



## THEORY OF OPERATION

The HMC525ACHIPS is a compact GaAs, MMIC, I/Q mixer. The device can be used as either an image reject mixer or a single sideband upconverter. The mixer uses two standard double balanced mixer cells and a 90° hybrid fabricated in a

GaAs, MESFET process. This device is a much smaller alternative to a hybrid style image reject mixer and a single sideband upconverter assembly.

## APPLICATIONS INFORMATION

Figure 100 shows the typical application circuit for the HMC525ACHIPS. To select the appropriate sideband, an external 90° hybrid is needed. For applications not requiring operation to dc, use an off-chip dc blocking capacitor. For applications that require suppression of the LO signal at the output, use a bias tee or RF feed as shown in Figure 100. Ensure that the source or sink current used for LO suppression is <math><2\text{ mA}</math> for each IFx port to prevent damage to the device. The common-mode voltage for each IFx port is 0 V.

To select the upper sideband when using as an upconverter, connect the IF1 pad to the 90° port of the hybrid and connect the IF2 pad to the 0° port of the hybrid. To select the lower

sideband, connect the IF1 pad to the 0° port of the hybrid and connect the IF2 pad to the 90° port of the hybrid. The input is from the sum port of the hybrid, and the difference port is 50  $\Omega$  terminated.

To select the upper sideband (low-side LO) when using as downconverter, connect the IF1 pad to the 0° port of the hybrid and connect the IF2 pad to the 90° port of the hybrid. To select the lower sideband (high-side LO), connect the IF1 pad to the 90° port of the hybrid and connect the IF2 pad to the 0° port of the hybrid. The output is from the sum port of the hybrid, and the difference port is 50  $\Omega$  terminated.

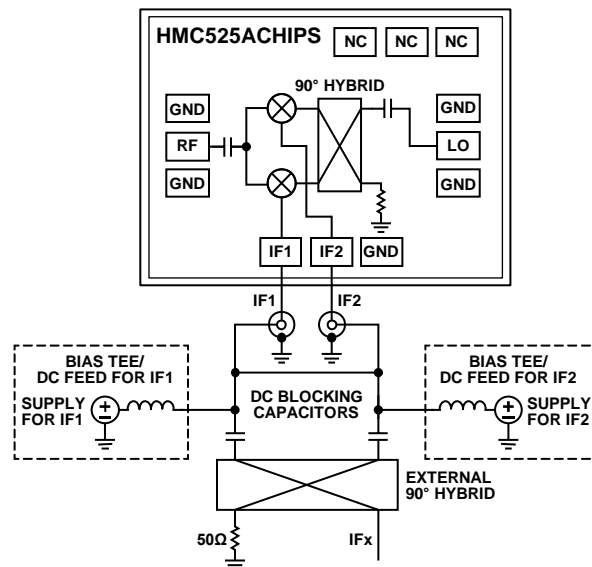
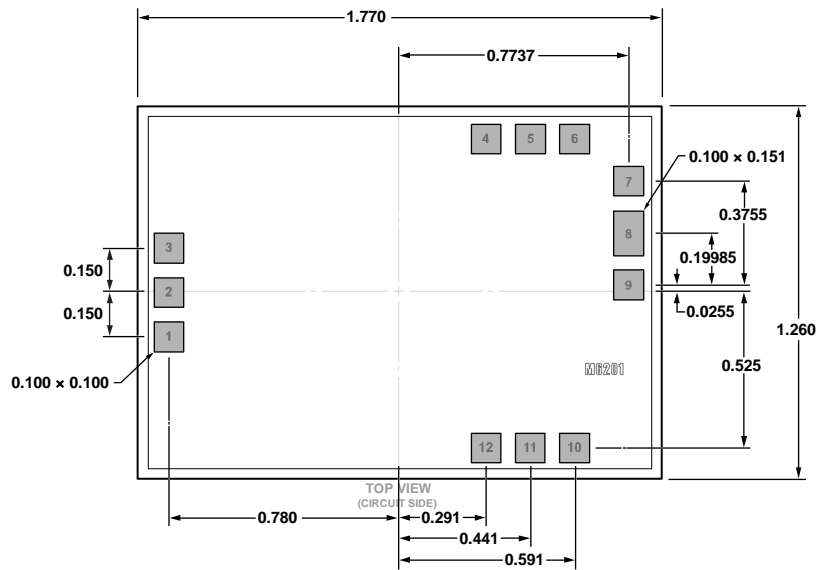

Figure 100. Typical Application Circuit

24048-100

# OUTLINE DIMENSIONS



03-10-2020-A

Figure 101. 12-Pad Bare Die [CHIP]  
(C-12-4)  
Dimensions shown in millimeters

## ORDERING GUIDE

Model <sup>1</sup>	Temperature Range	Package Description	Package Option
HMC525A	-40°C to +85°C	12-Pad Bare Die [CHIP]	C-12-4
HMC525A-SX	-40°C to +85°C	12-Pad Bare Die [CHIP]	C-12-4

<sup>1</sup> The HMC525A and HMC525A-SX are RoHS compliant parts.

## X-ON Electronics

Largest Supplier of Electrical and Electronic Components

*Click to view similar products for [RF Mixer](#) category:*

*Click to view products by [Analog Devices](#) manufacturer:*

Other Similar products are found below :

[HMC337-SX](#) [HMC404-SX](#) [mamx-009646-23dbml](#) [HMC339-SX](#) [HMC8192-SX](#) [MIQ24MS-2](#) [HMC220BMS8GETR](#) [M85C](#) [HMC554A-SX](#)  
[HMC8192LG](#) [HMC553AG-SX](#) [HMC521A-SX](#) [HMC521ACHIPS](#) [CMD258C4](#) [LT5511EFE](#) [MAMX-011023-SMB](#) [HMC399MS8TR](#)  
[HMC333TR](#) [HMC175MS8TR](#) [MAMXSS0012TR-3000](#) [109728-HMC129LC4](#) [CSM1-13](#) [SA612AD/01.112](#) [HMC785LP4ETR](#)  
[LT5526EUF#PBF](#) [LT5579IUH#PBF](#) [HMC773ALC3BTR](#) [HMC558ALC3B](#) [HMC329ALC3B](#) [MY63H](#) [AD8343ARUZ-REEL7](#) [AD608AR](#)  
[AD608ARZ](#) [AD831APZ](#) [AD831APZ-REEL7](#) [AD8342ACPZ-REEL7](#) [AD8343ARUZ](#) [AD8344ACPZ-REEL7](#) [ADL5350ACPZ-R7](#)  
[ADL5363ACPZ-R7](#) [ADL5365ACPZ-R7](#) [ADL5801ACPZ-R7](#) [ADL5802ACPZ-R7](#) [HMC1056LP4BE](#) [HMC1057-SX](#) [HMC1063LP3E](#)  
[HMC1093-SX](#) [HMC1106-SX](#) [HMC129](#) [HMC143](#)