



GaAs MMIC FUNDAMENTAL MIXER, 11 - 20 GHz

Typical Applications

The HMC554LC3B is ideal for:

- Point-to-Point Radios
- Point-to-Multi-Point Radios & VSAT
- Test Equipment & Sensors
- Military End-Use

Features

- High LO/RF Isolation: 46 dB
- Passive Double Balanced Topology
- Low Conversion Loss: 7 dB
- Wide IF Bandwidth: DC - 6 GHz
- Robust 1,000V ESD, Class 1C
- 12 Lead Ceramic 3x3mm SMT Package: 9mm²

Functional Diagram

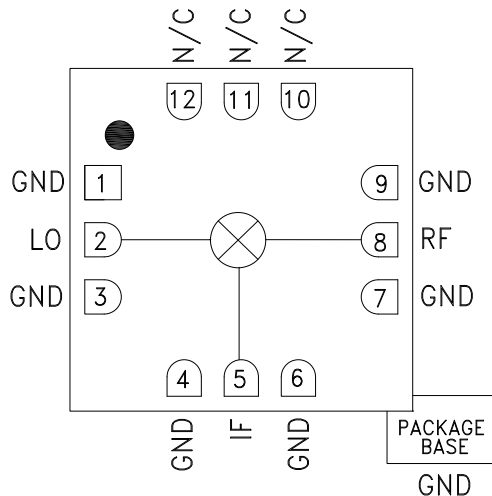

General Description

The HMC554LC3B is a general purpose double balanced mixer in a leadless RoHS compliant SMT package that can be used as an upconverter or downconverter between 11 and 20 GHz. This mixer is fabricated in a GaAs MESFET process, and requires no external components or matching circuitry. The HMC554LC3B provides excellent LO to RF and LO to IF isolation due to optimized balun structures. The RoHS compliant HMC554LC3B eliminates the need for wire bonding, and is compatible with high volume surface mount manufacturing techniques.

Electrical Specifications, $T_A = +25^\circ C$, $IF = 100 MHz$, $LO = +13 dBm^*$

| Parameter | Min. | Typ. | Max. | Min. | Typ. | Max. | Units |
|-------------------------------|------|---------|------|---------|------|------|-------|
| Frequency Range, RF & LO | | 12 - 16 | | 11 - 20 | | | GHz |
| Frequency Range, IF | | DC - 6 | | DC - 6 | | | GHz |
| Conversion Loss | | 7 | 9 | | 8 | 11 | dB |
| Noise Figure (SSB) | | 7 | 9 | | 8 | 11 | dB |
| LO to RF Isolation | 40 | 46 | | 40 | 46 | | dB |
| LO to IF Isolation | 34 | 40 | | 30 | 40 | | dB |
| RF to IF Isolation | 18 | 25 | | 15 | 25 | | dB |
| IP3 (Input) | | 18 | | | 18 | | dBm |
| IP2 (Input) | | 48 | | | 45 | | dBm |
| 1 dB Gain Compression (Input) | | 11 | | | 11 | | dBm |

*Unless otherwise noted, all measurements performed as downconverter, IF = 100 MHz.



GaAs MMIC FUNDAMENTAL MIXER, 11 - 20 GHz

Conversion Gain vs. Temperature @ LO = +13 dBm

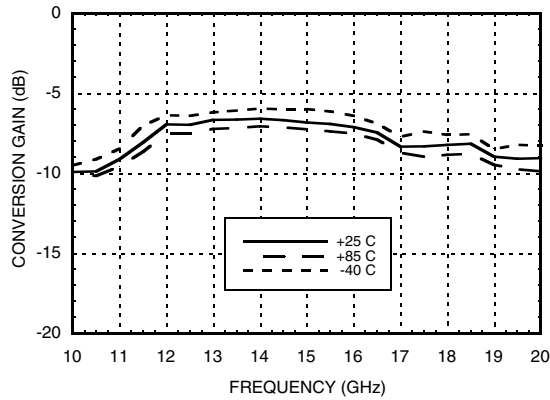

Isolation @ LO = +13 dBm

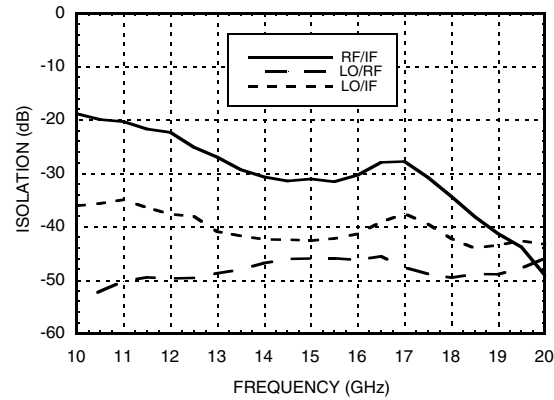

Conversion Gain vs. LO Drive

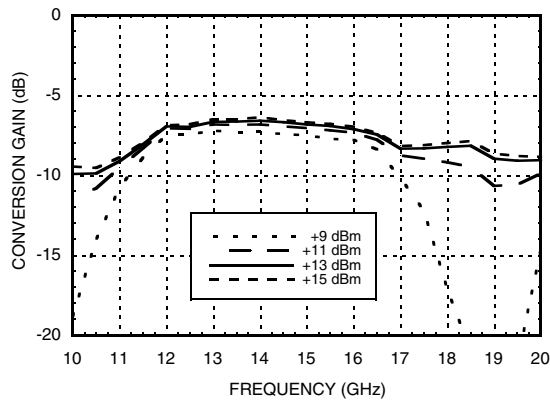

Return Loss @ LO = +13 dBm

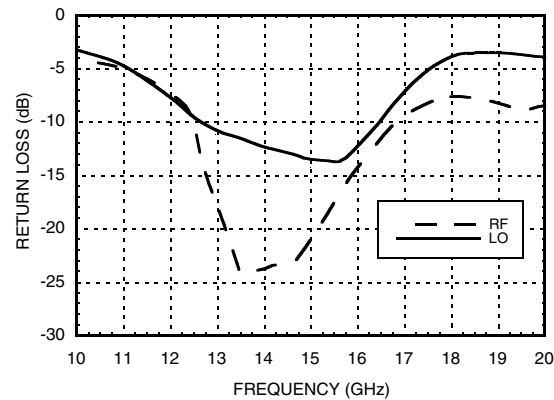

IF Bandwidth @ LO = +13 dBm

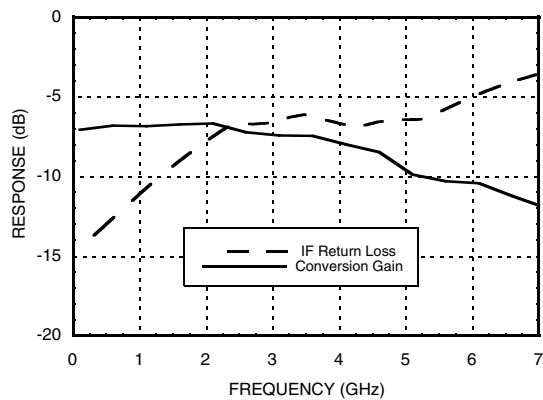

Upconverter Performance Conversion Gain vs. LO Drive

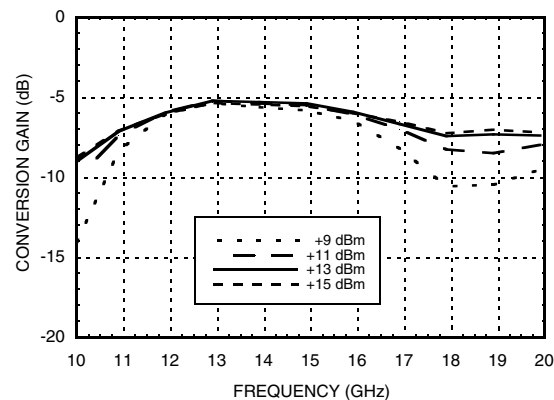

Information furnished by Analog Devices is believed to be accurate and reliable. However, no responsibility is assumed by Analog Devices for its use, nor for any infringements of patents or other rights of third parties that may result from its use. Specifications subject to change without notice. No license is granted by implication or otherwise under any patent or patent rights of Analog Devices. Trademarks and registered trademarks are the property of their respective owners.

For price, delivery, and to place orders: Analog Devices, Inc., One Technology Way, P.O. Box 9106, Norwood, MA 02062-9106 Phone: 781-329-4700 • Order online at www.analog.com Application Support: Phone: 1-800-ANALOG-D



GaAs MMIC FUNDAMENTAL MIXER, 11 - 20 GHz

Input IP3 vs. LO Drive *

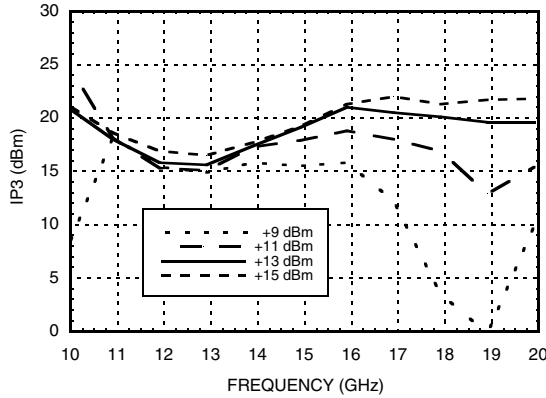

Input IP3 vs. Temperature @ LO = +13 dBm*

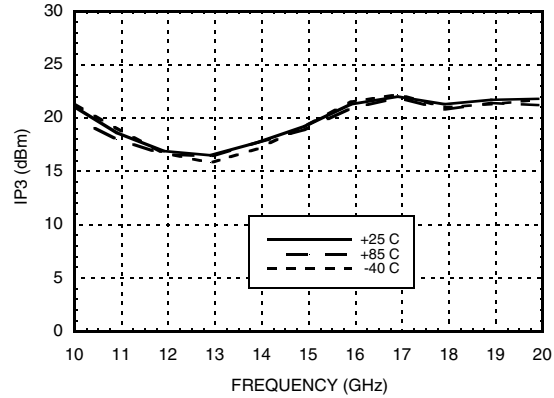

Input IP2 vs. LO Drive *

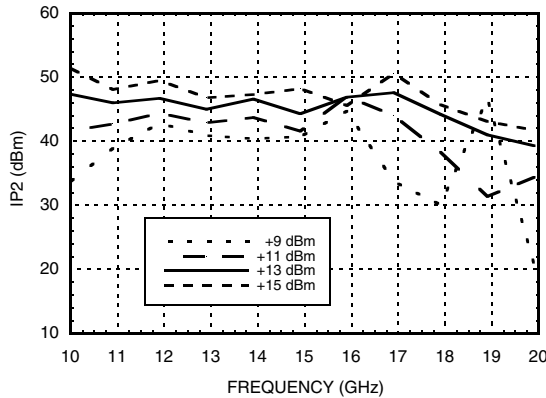

Input IP2 vs. Temperature @ LO = +13 dBm*

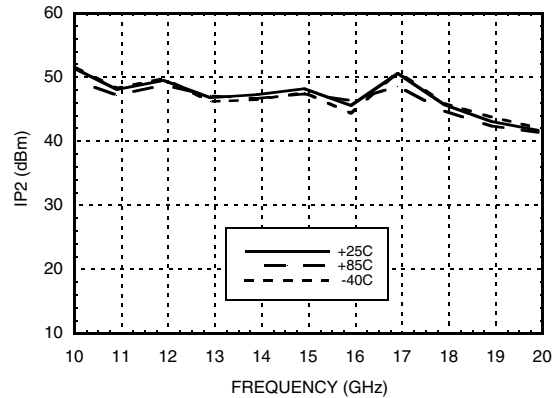

Input P1dB vs. Temperature @ LO = +13 dBm

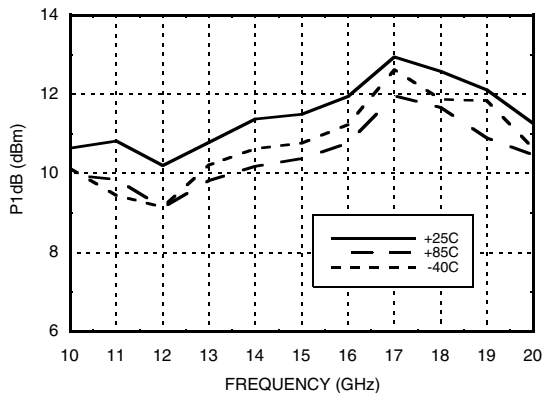

MxN Spurious Outputs

| | | nLO | | | | |
|-----|--|-----|----|-----|----|-----|
| mRF | | 0 | 1 | 2 | 3 | 4 |
| 0 | | xx | 19 | 25 | xx | xx |
| 1 | | 29 | 0 | 51 | 55 | xx |
| 2 | | 81 | 85 | 60 | 88 | 104 |
| 3 | | xx | 97 | 98 | 76 | 99 |
| 4 | | xx | xx | 105 | 98 | 105 |

RF = 15.1 GHz @ -10 dBm
 LO = 15.0 GHz @ +13 dBm
 All values in dBc below the IF output power level.

* Two-tone input power = -10 dBm each tone, 1 MHz spacing.

Information furnished by Analog Devices is believed to be accurate and reliable. However, no responsibility is assumed by Analog Devices for its use, nor for any infringements of patents or other rights of third parties that may result from its use. Specifications subject to change without notice. No license is granted by implication or otherwise under any patent or patent rights of Analog Devices. Trademarks and registered trademarks are the property of their respective owners.

For price, delivery, and to place orders: Analog Devices, Inc., One Technology Way, P.O. Box 9106, Norwood, MA 02062-9106 Phone: 781-329-4700 • Order online at www.analog.com Application Support: Phone: 1-800-ANALOG-D



GaAs MMIC FUNDAMENTAL MIXER, 11 - 20 GHz

Absolute Maximum Ratings

| | |
|--|----------------|
| RF / IF Input | +25 dBm |
| LO Drive | +25 dBm |
| Channel Temperature | 150 °C |
| Continuous Pdiss (T= 85 °C) (derate 2.32 mW/°C above 85 °C) | 150 mW |
| Thermal Resistance (channel to ground paddle) | 431 °C/W |
| Storage Temperature | -65 to +150 °C |
| Operating Temperature | -40 to +85 °C |
| ESD Sensitivity (HBM) | Class 1C |



ELECTROSTATIC SENSITIVE DEVICE
OBSERVE HANDLING PRECAUTIONS

Outline Drawing

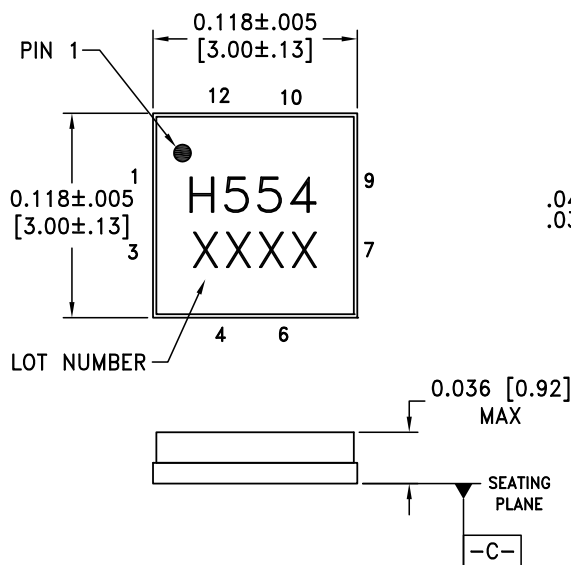

BOTTOM VIEW

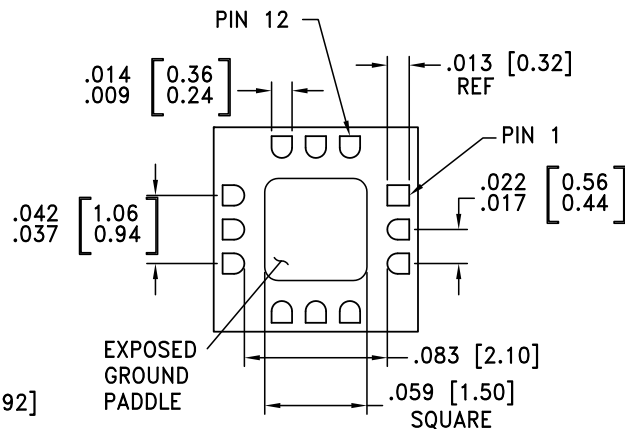

NOTES:

1. PACKAGE BODY MATERIAL: ALUMINA.
2. LEAD AND GROUND PADDLE PLATING:
30-80 MICROINCHES GOLD OVER 50 MICROINCHES MINIMUM NICKEL.
3. DIMENSIONS ARE IN INCHES (MILLIMETERS).
4. LEAD SPACING TOLERANCE IS NON-CUMULATIVE.
5. CHARACTERS TO BE HELVETICA MEDIUM, .025 HIGH, BLACK INK, OR LASER MARK LOCATED APPROX. AS SHOWN.
6. PACKAGE WARP SHALL NOT EXCEED 0.05MM DATUM - C -
7. ALL GROUND LEADS AND GROUND PADDLE MUST BE SOLDERED TO PCB RF GROUND.

Package Information

| Part Number | Package Body Material | Lead Finish | MSL Rating | Package Marking ^[2] |
|-------------|-----------------------|------------------|---------------------|--------------------------------|
| HMC554LC3B | Alumina, White | Gold over Nickel | MSL3 ^[1] | H554 XXXX |

[1] Max peak reflow temperature of 260 °C

[2] 4-Digit lot number XXXX

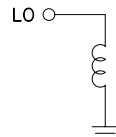
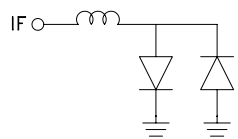
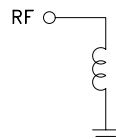

Pin Descriptions

| Pin Number | Function | Description | Interface Schematic |
|------------------|----------|--|--|
| 1, 3, 4, 6, 7, 9 | GND | Package bottom must also be connected to RF/DC ground. |  |
| 2 | LO | This pin is DC coupled and matched to 50 Ohms. |  |
| 5 | IF | This pin is DC coupled. For applications not requiring operation to DC, this port should be DC blocked externally using a series capacitor whose value has been chosen to pass the necessary IF frequency range. For operation to DC, this pin must not source or sink more than 2 mA of current or part non-function and possible part failure will result. |  |
| 8 | RF | This pin is DC coupled and matched to 50 Ohms. |  |
| 10, 11, 12 | N/C | No connection required. These pins may be connected to RF/DC ground without affecting performance. | |



GaAs MMIC FUNDAMENTAL MIXER, 11 - 20 GHz

Evaluation PCB

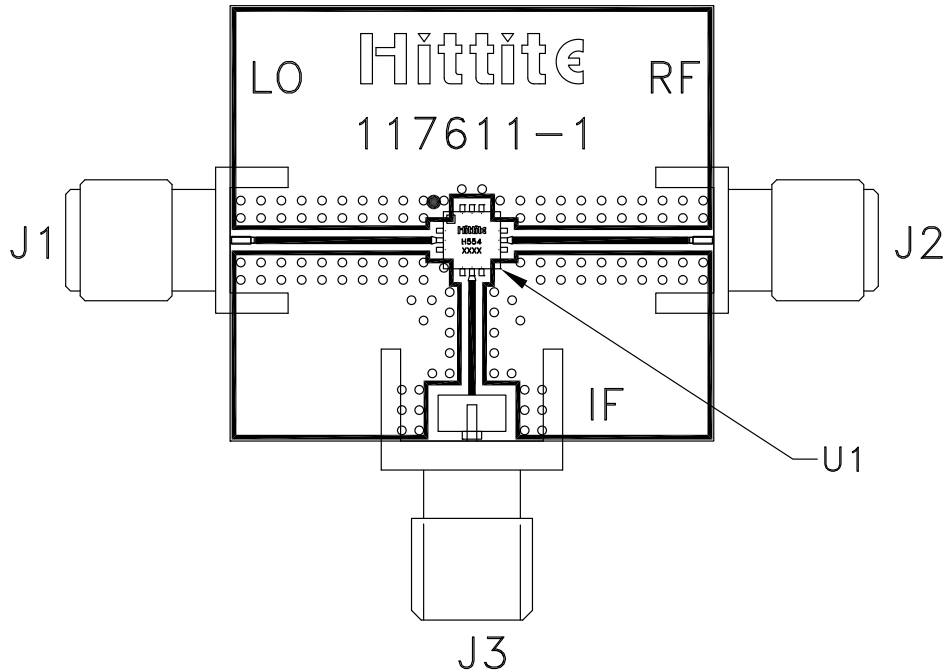

List of Materials for Evaluation PCB 109952 [1]

| Item | Description |
|---------|-----------------------|
| J1 - J2 | SRI SMA Connector |
| J3 | Johnson SMA Connector |
| U1 | HMC554LC3B Mixer |
| PCB [2] | 117611 Evaluation PCB |

[1] Reference this number when ordering complete evaluation PCB

[2] Circuit Board Material: Arlon 25 FR

The circuit board used in this application should use RF circuit design techniques. Signal lines should have 50 Ohm impedance while the package ground leads and exposed paddle should be connected directly to the ground plane similar to that shown. A sufficient number of via holes should be used to connect the top and bottom ground planes. The evaluation circuit board shown is available from Hittite upon request.

X-ON Electronics

Largest Supplier of Electrical and Electronic Components

Click to view similar products for [RF Mixer](#) category:

Click to view products by [Analog Devices](#) manufacturer:

Other Similar products are found below :

[HMC337-SX](#) [HMC404-SX](#) [mamx-009646-23dbml](#) [HMC339-SX](#) [HMC8192-SX](#) [MIQ24MS-2](#) [HMC220BMS8GETR](#) [M85C](#) [HMC554A-SX](#)
[HMC8192LG](#) [HMC553AG-SX](#) [HMC521A-SX](#) [HMC521ACHIPS](#) [CMD258C4](#) [LT5511EFE](#) [MAMX-011023-SMB](#) [HMC399MS8TR](#)
[HMC333TR](#) [HMC175MS8TR](#) [MAMXSS0012TR-3000](#) [109728-HMC129LC4](#) [CSM1-13](#) [SA612AD/01.112](#) [HMC785LP4ETR](#)
[LT5526EUF#PBF](#) [LT5579IUH#PBF](#) [HMC773ALC3BTR](#) [HMC558ALC3B](#) [HMC329ALC3B](#) [MY63H](#) [AD8343ARUZ-REEL7](#) [AD608AR](#)
[AD608ARZ](#) [AD831APZ](#) [AD831APZ-REEL7](#) [AD8342ACPZ-REEL7](#) [AD8343ARUZ](#) [AD8344ACPZ-REEL7](#) [ADL5350ACPZ-R7](#)
[ADL5363ACPZ-R7](#) [ADL5365ACPZ-R7](#) [ADL5801ACPZ-R7](#) [ADL5802ACPZ-R7](#) [HMC1056LP4BE](#) [HMC1057-SX](#) [HMC1063LP3E](#)
[HMC1093-SX](#) [HMC1106-SX](#) [HMC129](#) [HMC143](#)