



GaAs SMT pHEMT LOW NOISE AMPLIFIER, 1.2 - 2.2 GHz

Typical Applications

The HMC618ALP3E is ideal for:

- Cellular/3G and LTE/WiMAX/4G
- BTS & Infrastructure
- Repeaters and Femto Cells
- Public Safety Radios

Features

- Noise Figure: 0.75 dB
- Gain: 19 dB
- OIP3: 36 dBm
- Single Supply: +3V to +5V
- 50 Ohm Matched Input/Output
- 16 Lead 3x3mm SMT Package: 9 mm²

Functional Diagram

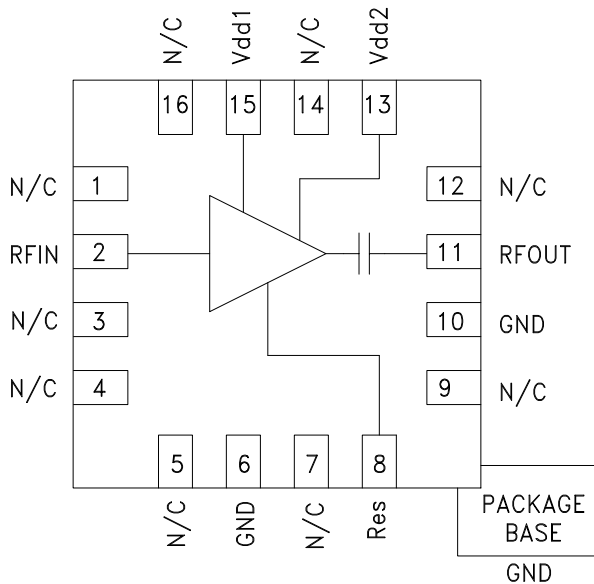

General Description

The HMC618ALP3E is a GaAs pHEMT MMIC Low Noise Amplifier that is ideal for Cellular/3G and LTE/WiMAX/4G basestation front-end receivers operating between 1.2 - 2.2 GHz. The amplifier has been optimized to provide 0.75 dB noise figure, 19 dB gain and +36 dBm output IP3 from a single supply of +5V. Input and output return losses are excellent and the LNA requires minimal external matching and bias decoupling components. The HMC618ALP3E shares the same package and pinout with the HMC617LP3E 0.55 - 1.2 GHz LNA. The HMC618ALP3E can be biased with +3V to +5V and features an externally adjustable supply current which allows the designer to tailor the linearity performance of the LNA for each application. The HMC618ALP3E offers improved noise figure versus the previously released HMC375LP3(E) and the HMC382LP3(E).

Electrical Specifications

$T_A = +25^\circ\text{C}$, $R_{bias} = 470\text{ Ohm}$ for $V_{dd1} = V_{dd2} = 5\text{V}$

Parameter	Vdd = 5 Vdc									Units
	Min.	Typ.	Max.	Min.	Typ.	Max.	Min.	Typ.	Max.	
Frequency Range	1200 - 1700			1700 - 2000			2000 - 2200			MHz
Gain	19	23		16	19		13.5	17		dB
Gain Variation Over Temperature		0.012			0.008			0.008		dB/°C
Noise Figure		0.65	0.85		0.75	1.1		0.85	1.15	dB
Input Return Loss		22.5			18			19.5		dB
Output Return Loss		13			12.5			10		dB
Output Power for 1 dB Compression (P1dB)		19		16.5	20		18	20		dBm
Saturated Output Power (Psat)		20.5			20.5			20.5		dBm
Output Third Order Intercept (IP3)	29.4	33.5		29.5	35		30.4	35.5		dBm
Supply Current (Idd)		89	118		89	118		89	118	mA

* Rbias resistor sets current, see application circuit herein



GaAs SMT pHEMT LOW NOISE AMPLIFIER, 1.2 - 2.2 GHz

Electrical Specifications

$T_A = +25^\circ\text{C}$, $R_{\text{bias}} = 10\text{K Ohm}$ for $V_{\text{dd1}} = V_{\text{dd2}} = 3\text{V}$

Parameter	Vdd = 3 Vdc									Units
	Min.	Typ.	Max.	Min.	Typ.	Max.	Min.	Typ.	Max.	
Frequency Range	1200 - 1700			1700 - 2000			2000 - 2200			MHz
Gain	18	22		15	18		12.5	15.8		dB
Gain Variation Over Temperature		0.009			0.009			0.009		dB/°C
Noise Figure		0.8	1.1		0.9	1.2		0.9	1.2	dB
Input Return Loss		26			17			19		dB
Output Return Loss		14			13			11		dB
Output Power for 1 dB Compression (P1dB)	10	15		12	15		13	15		dBm
Saturated Output Power (Psat)		16			16			16		dBm
Output Third Order Intercept (IP3)		28			28			28		dBm
Supply Current (Idd)		47	65		47	65		47	65	mA

* Rbias resistor sets current, see application circuit herein

1700 to 2200 MHz Tune

Broadband Gain & Return Loss ^[1] ^[2]

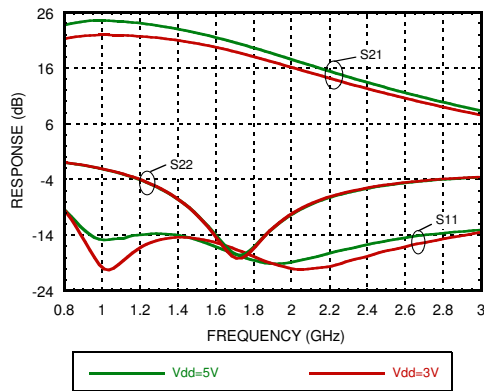

Gain vs. Temperature ^[1]

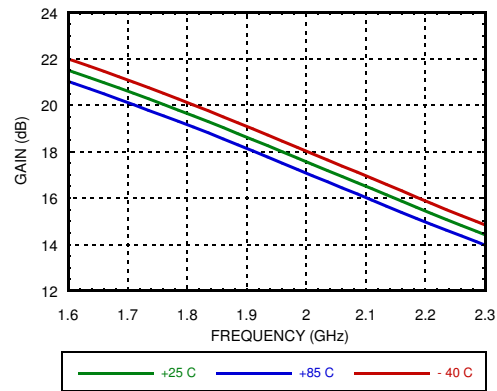

Gain vs. Temperature ^[2]

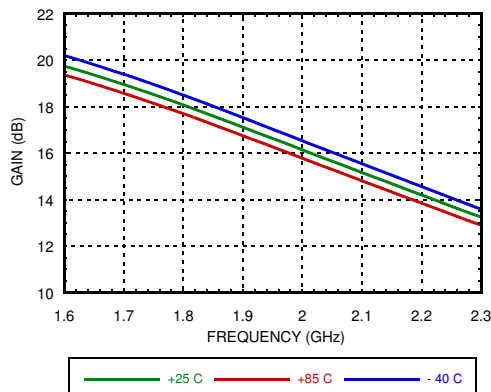

Input Return Loss vs. Temperature ^[1]

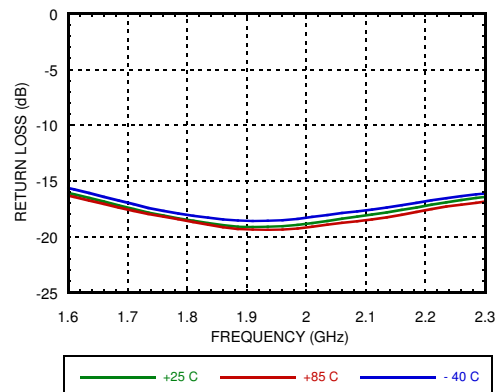

[1] Vdd = 5V, Rbias = 470 Ohm [2] Vdd = 3V, Rbias = 10K Ohm

GaAs SMT pHEMT LOW NOISE AMPLIFIER, 1.2 - 2.2 GHz

1700 to 2200 MHz Tune

Output Return Loss vs. Temperature [1]

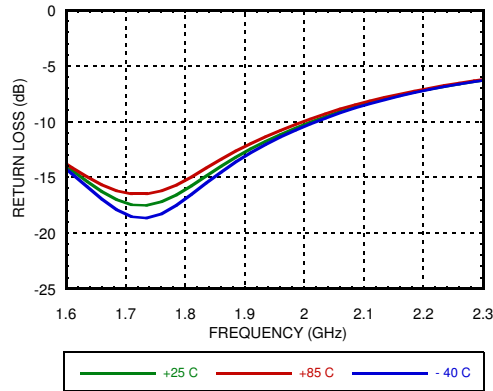

Reverse Isolation vs. Temperature [1]

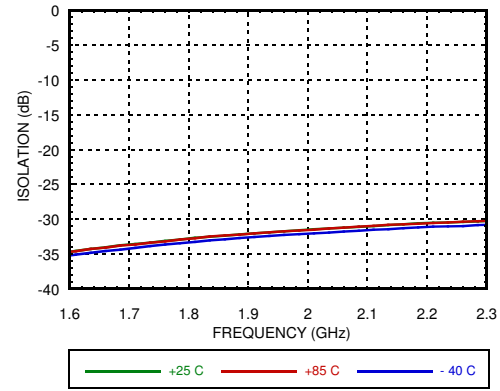

Noise Figure vs Temperature [1] [2] [3]

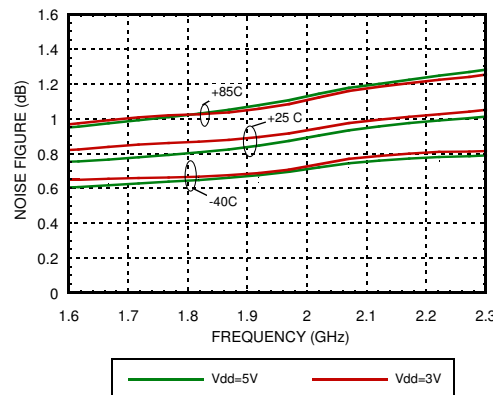

Output P1dB vs. Temperature [1] [2]

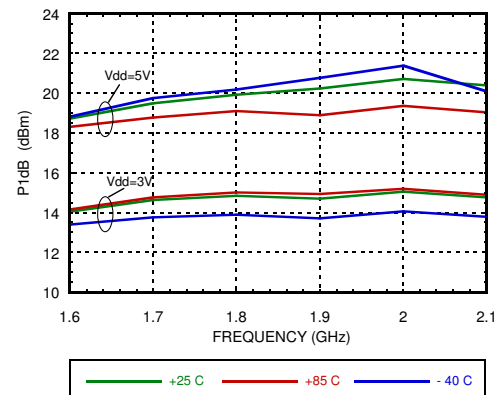

Psat vs. Temperature [1] [2]

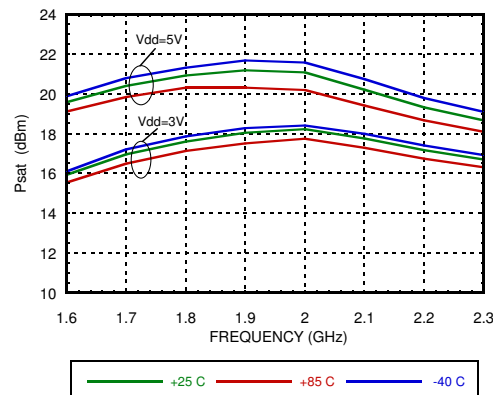

Output IP3 vs. Temperature [1] [2]

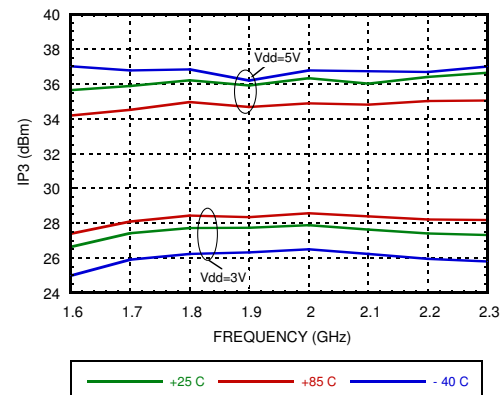

[1] Vdd = 5V, Rbias = 470 Ohm [2] Vdd = 3V, Rbias = 10K Ohm
[3] Measurement reference plane shown on evaluation PCB drawing.

1700 to 2200 MHz Tune

Output IP3 and Idd vs. Supply Voltage @ 1700 MHz [1]

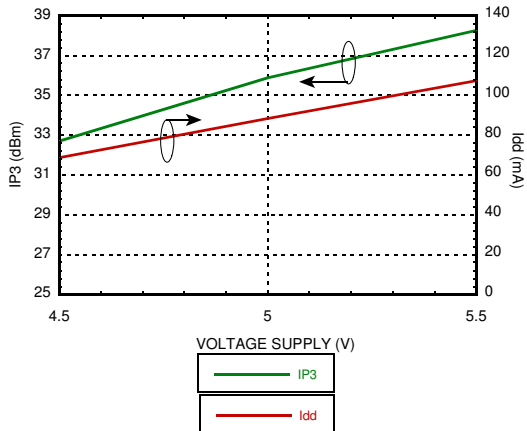

Output IP3 and Idd vs. Supply Voltage @ 1700 MHz [2]

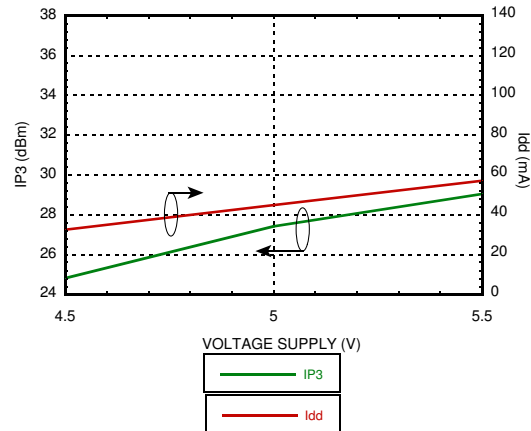

Output IP3 and Idd vs. Supply Voltage @ 2100 MHz [1]

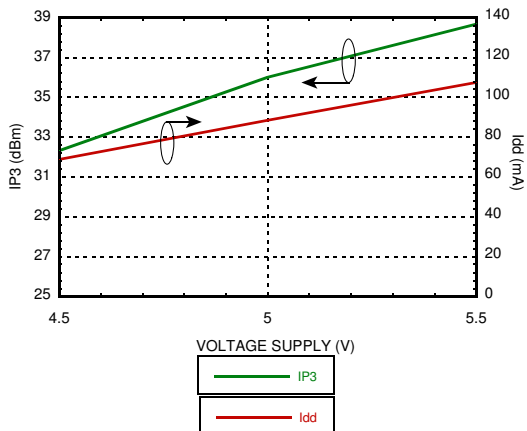

Output IP3 and Idd vs. Supply Voltage @ 2100 MHz [2]

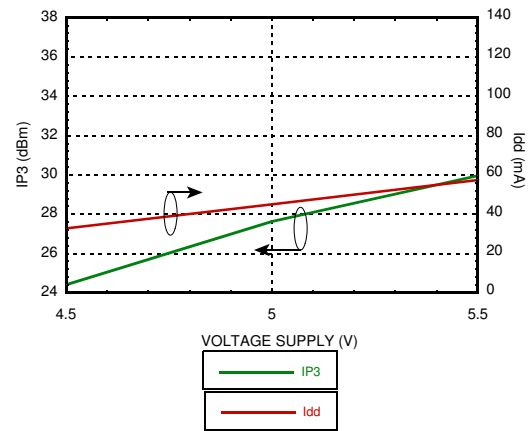

Power Compression @ 1700 MHz [1]

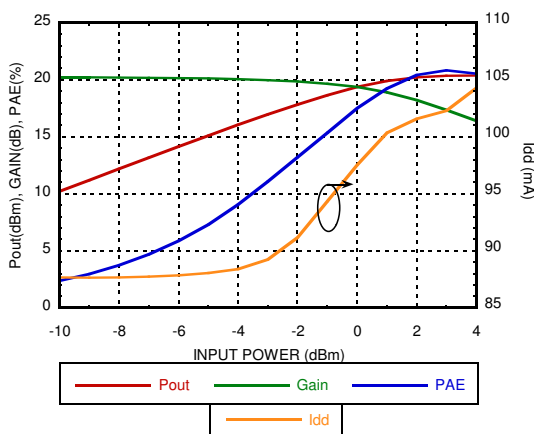

Power Compression @ 1700 MHz [2]

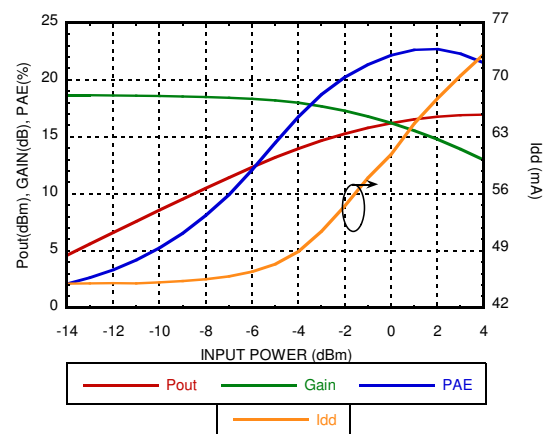

[1] Vdd = 5V, Rbias = 470 Ohm [2] Vdd = 3V, Rbias = 10K Ohm



GaAs SMT pHEMT LOW NOISE AMPLIFIER, 1.2 - 2.2 GHz

1700 to 2200 MHz Tune

AMPLIFIERS - LOW NOISE - SMT

Power Compression @ 2100 MHz [1]

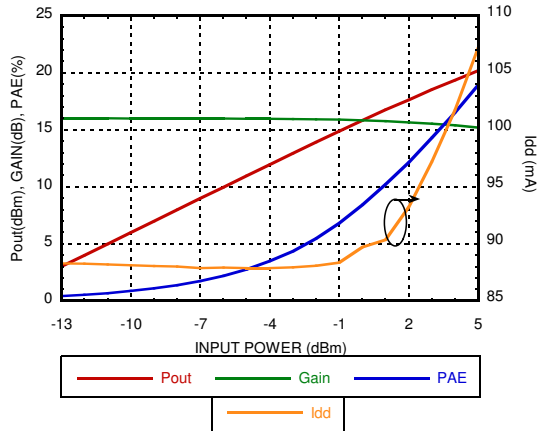

Power Compression @ 2100 MHz [2]

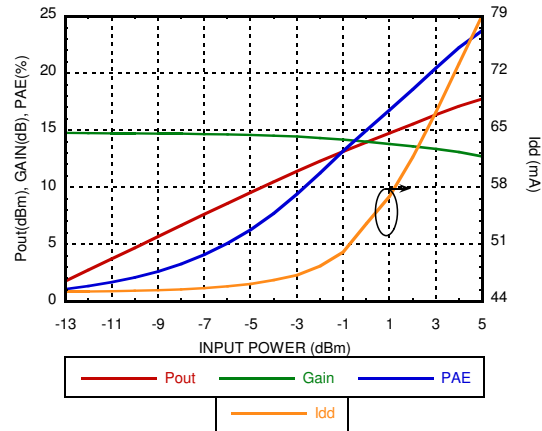

Gain, Power & Noise Figure vs. Supply Voltage @ 1700 MHz [1]

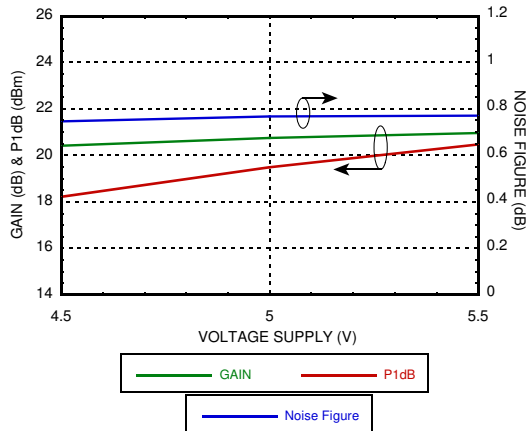

Gain, Power & Noise Figure vs. Supply Voltage @ 1700 MHz [2]

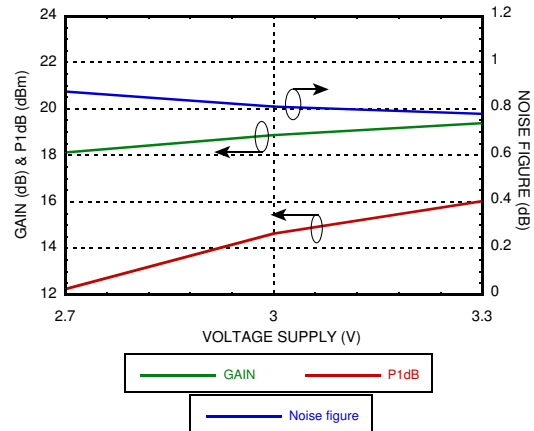

Gain, Power & Noise Figure vs. Supply Voltage @ 2100 MHz [1]

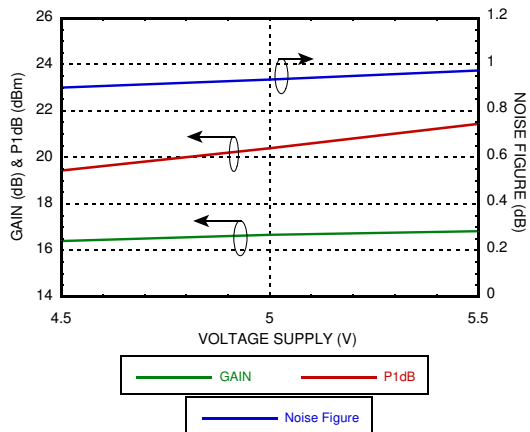

Gain, Power & Noise Figure vs. Supply Voltage @ 2100 MHz [2]

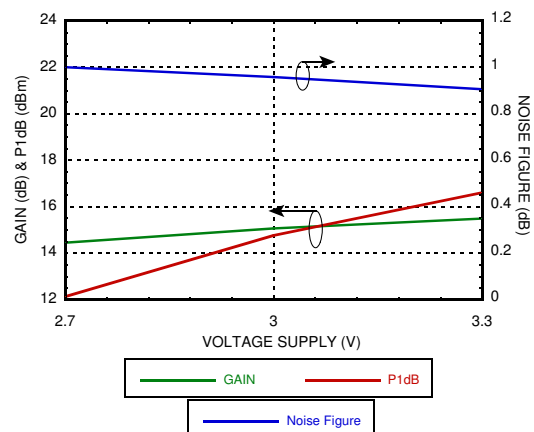

[1] Vdd = 5V, Rbias = 470 Ohm [2] Vdd = 3V, Rbias = 10K Ohm

1700 to 2200 MHz Tune

Output IP3 vs. Rbias @ 1700 MHz

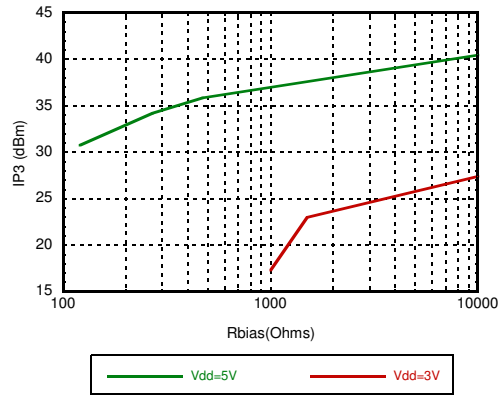

Gain, Noise Figure vs. Rbias @ 1700 MHz

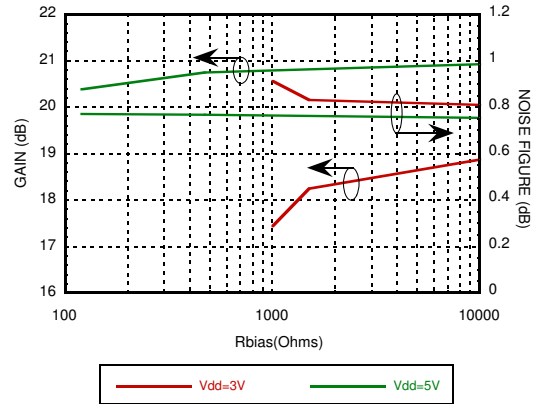

Output IP3 vs. Rbias @ 2100 MHz

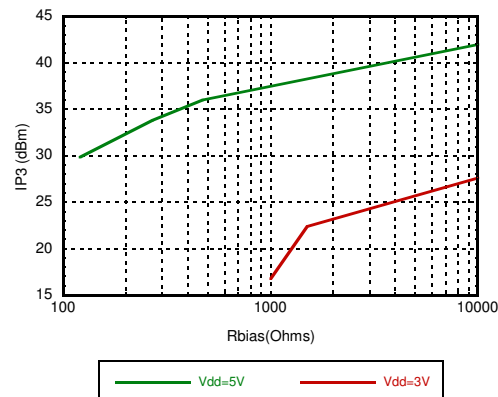

Gain, Noise Figure vs. Rbias @ 2100 MHz

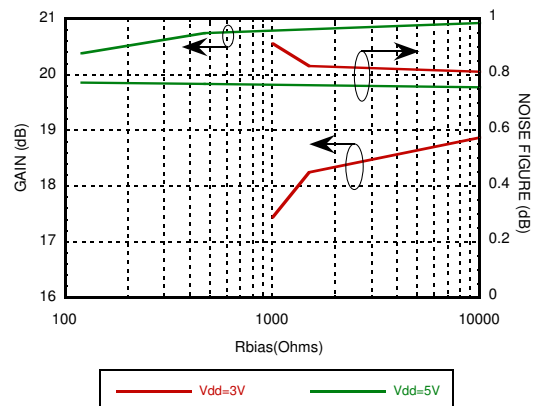

[1] Vdd = 5V, Rbias = 470 Ohm [2] Vdd = 3V, Rbias = 10K Ohm



GaAs SMT pHEMT LOW NOISE AMPLIFIER, 1.2 - 2.2 GHz

1200 to 1700 MHz Tune

Gain vs. Temperature [1]

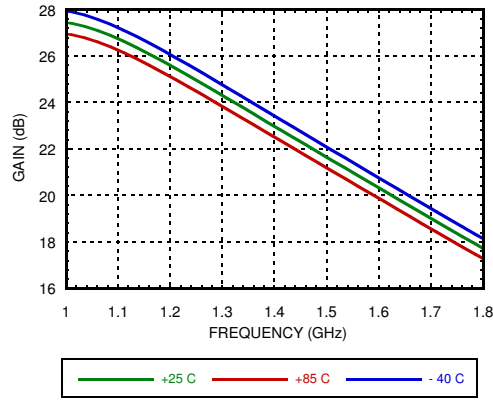

Gain vs. Temperature [2]

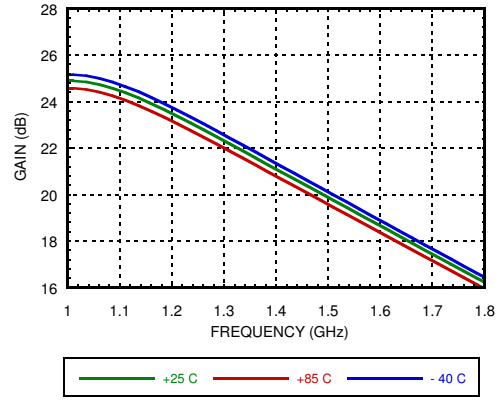

Input Return Loss vs. Temperature [1]

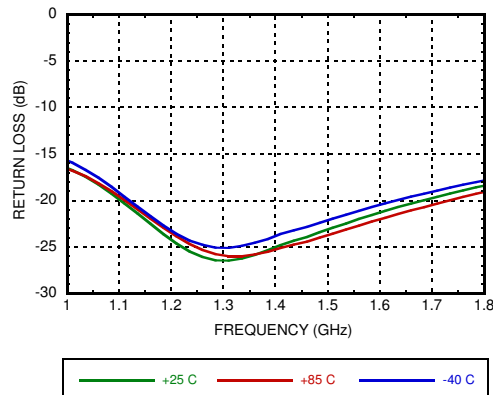

Input Return Loss vs. Temperature [2]

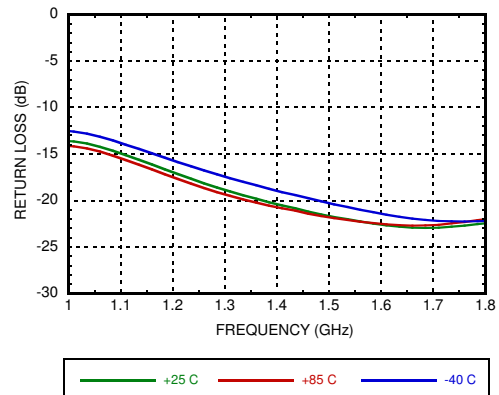

Output Return Loss vs. Temperature [1]

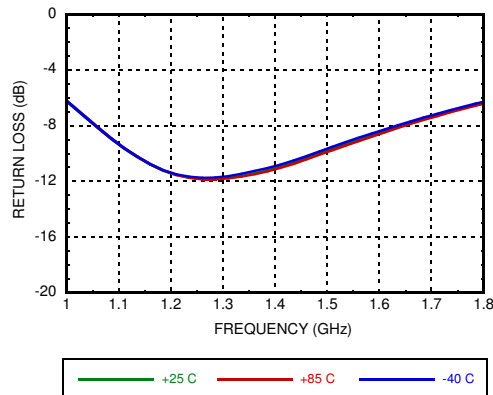

Output Return Loss vs. Temperature [2]

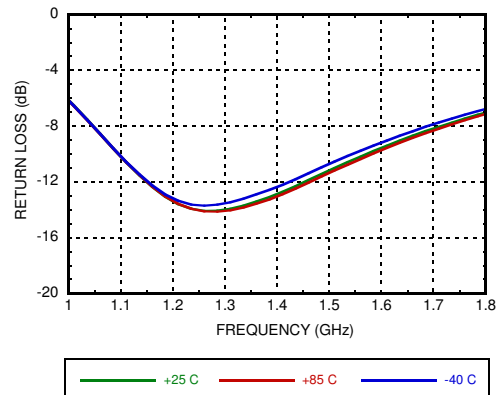

[1] Vdd = 5V, Rbias = 470 Ohm [2] Vdd = 3V, Rbias = 10K Ohm



GaAs SMT pHEMT LOW NOISE AMPLIFIER, 1.2 - 2.2 GHz

1200 to 1700 MHz Tune

Reverse Isolation vs. Temperature [1]

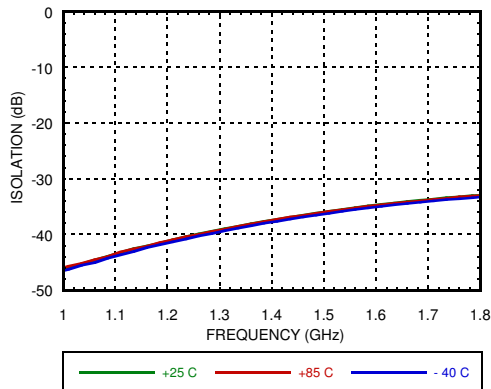

Reverse Isolation vs. Temperature [2]

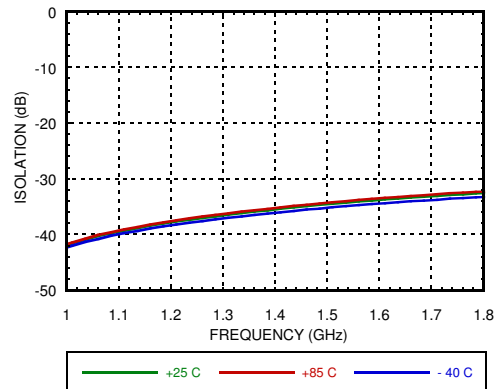

Noise Figure vs. Temperature [1]

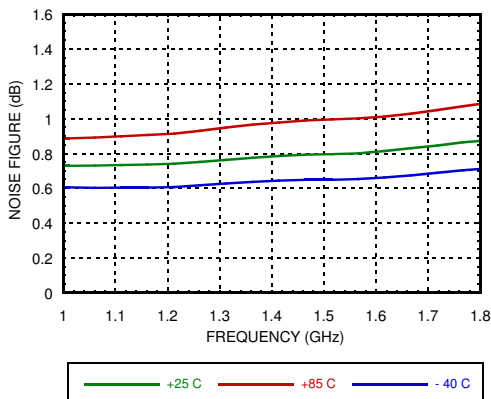

Noise Figure vs. Temperature [2]

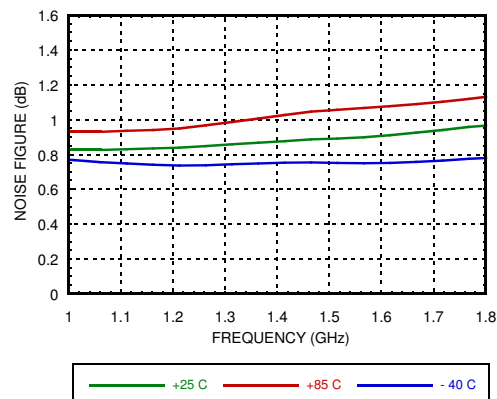

Output P1dB vs. Temperature [1]

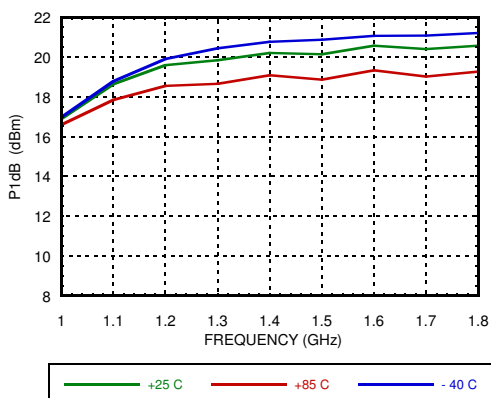

Output P1dB vs. Temperature [2]

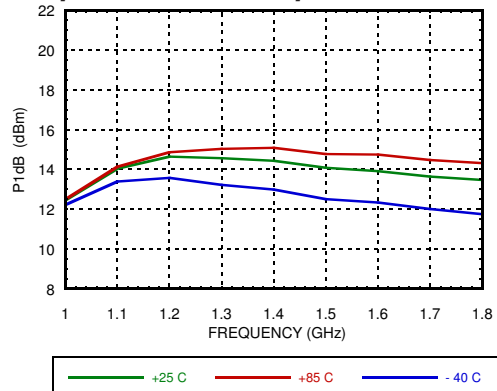

[1] Vdd = 5V, Rbias = 470 Ohm [2] Vdd = 3V, Rbias = 10K Ohm



GaAs SMT pHEMT LOW NOISE AMPLIFIER, 1.2 - 2.2 GHz

1200 to 1700 MHz Tune

AMPLIFIERS - LOW NOISE - SMT

Psat vs. Temperature [1]

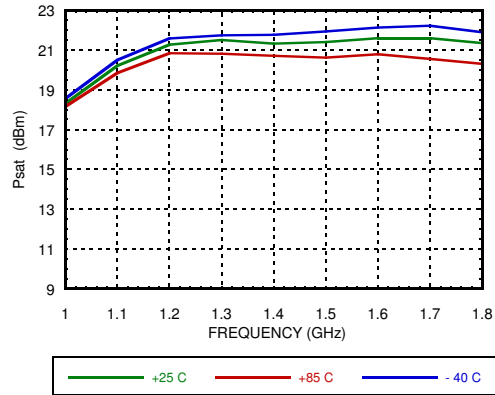

Psat vs. Temperature [2]

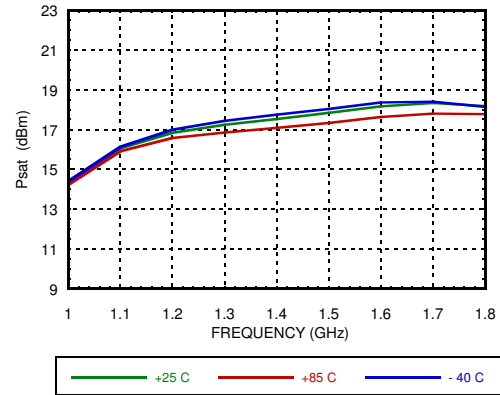

Output IP3 vs. Temperature [1]

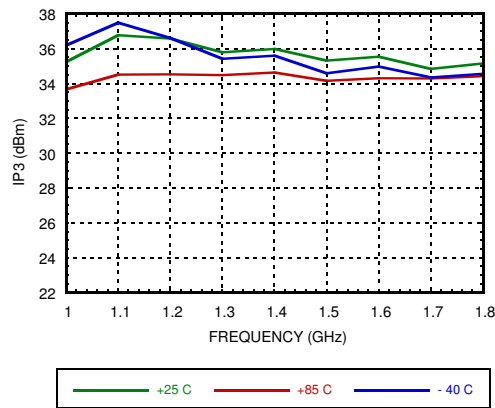

Output IP3 vs. Temperature [2]

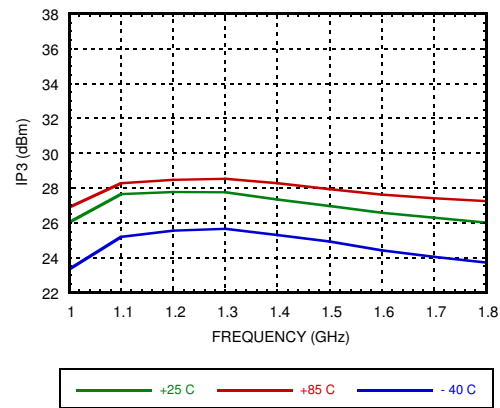

Absolute Bias Resistor

Range & Recommended Bias Resistor Values for Idd

Vdd1 = Vdd2 (V)	Rbias			Idd1 + Idd2 (mA)
	Min (Ohms)	Max (Ohms)	R1 (Ohms)	
3V	1K [3]	Open Circuit	1k	28
			1.5k	34
			10k	47
5V	0	Open Circuit	120	71
			270	84
			470	89

[1] Vdd = 5V, Rbias = 470 Ohm [2] Vdd = 3V, Rbias = 10K Ohm

[3] With Vdd= 3V and Rbias < 1K Ohm may result in the part becoming conditionally stable which is not recommended.



GaAs SMT pHEMT LOW NOISE AMPLIFIER, 1.2 - 2.2 GHz

Absolute Maximum Ratings

Drain Bias Voltage (Vdd1, Vdd2)	+6V
RF Input Power (RFIN) (Vdd = +5 Vdc)	+10 dBm
Channel Temperature	150 °C
Continuous Pdiss (T= 85 °C) (derate 9.68 mW/°C above 85 °C)	0.63 W
Thermal Resistance (channel to ground paddle)	103.4 °C/W
Storage Temperature	-65 to +150 °C
Operating Temperature	-40 to +85 °C
ESD Sensitivity (HBM)	Class 1A, Passed 250V

Typical Supply Current vs. Vdd

Rbias = 10 KOhm for 3V

Rbias = 470 Ohm for 5V

Vdd (Vdc)	Idd (mA)
2.7	35
3.0	47
3.3	58
4.5	72
5.0	89
5.5	106

Note: Amplifier will operate over full voltage ranges shown above.



ELECTROSTATIC SENSITIVE DEVICE
OBSERVE HANDLING PRECAUTIONS

Outline Drawing

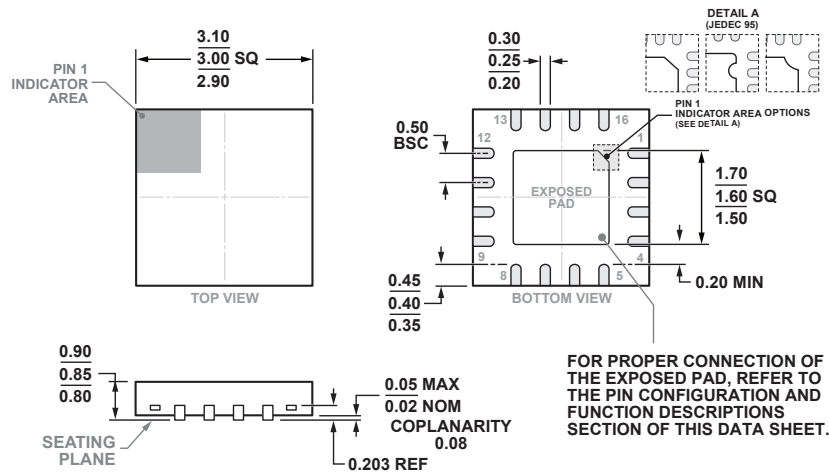

COMPLIANT TO JEDEC STANDARDS MO-220-VEED-4

16-Lead Lead Frame Chip Scale Package [LFCSP]
3 mm x 3 mm Body and 0.85 mm Package Height
(CP-16-50)

Dimensions shown in millimeters

Package Information

Part Number	Package Body Material	Lead Finish	MSL Rating	Package Marking [2]
HMC618ALP3E	Alumina White	Gold over Nickel	MSL3 [1]	618A XXXX

[1] Max peak reflow temperature of 260 °C

[2] 4-Digit lot number XXXX



GaAs SMT pHEMT LOW NOISE AMPLIFIER, 1.2 - 2.2 GHz

Pin Description

Pin Number	Function	Description	Interface Schematic
1, 3 - 5, 7, 9, 12, 14, 16	N/C	No connection required. These pins may be connected to RF/DC ground without affecting performance.	
2	RFIN	This pin is DC coupled and matched to 50 Ohms.	
6, 10	GND	This pin and ground paddle must be connected to RC/DC ground.	
8	RES	This pin is used to set the DC current of the amplifier by selection of the external bias resistor. See application circuit.	
11	RFOUT	This pin is matched to 50 Ohms.	
13, 15	Vdd2, Vdd1	Power Supply Voltage for the amplifier. External bypass capacitors of 1000 pF, and 0.47 μF are required.	

Application Circuit, 1700 to 2200 MHz Tune

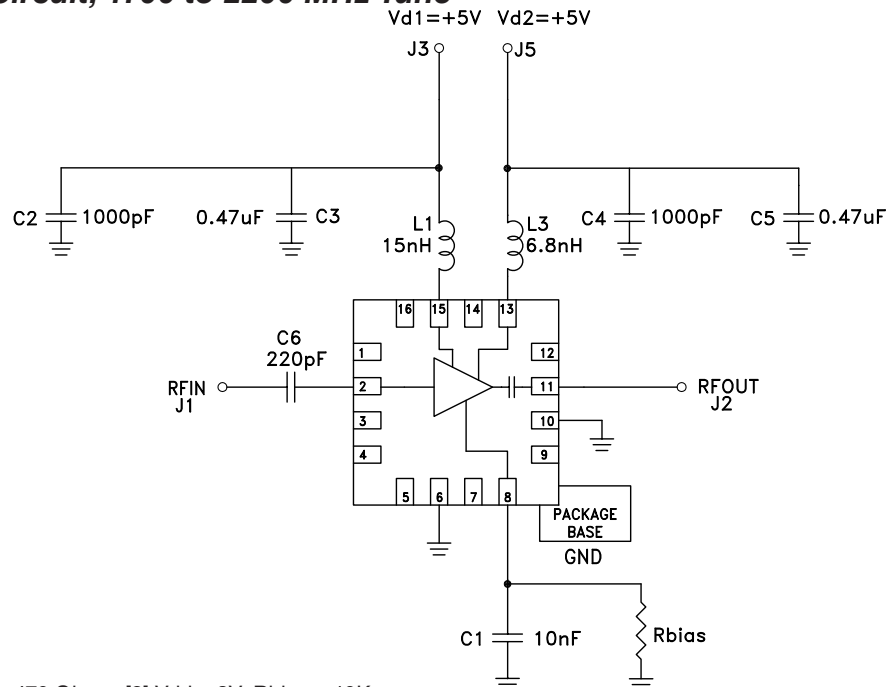

[1] Vdd = 5V, Rbias = 470 Ohm [2] Vdd = 3V, Rbias = 10K

Evaluation PCB, 1700 to 2200 MHz Tune

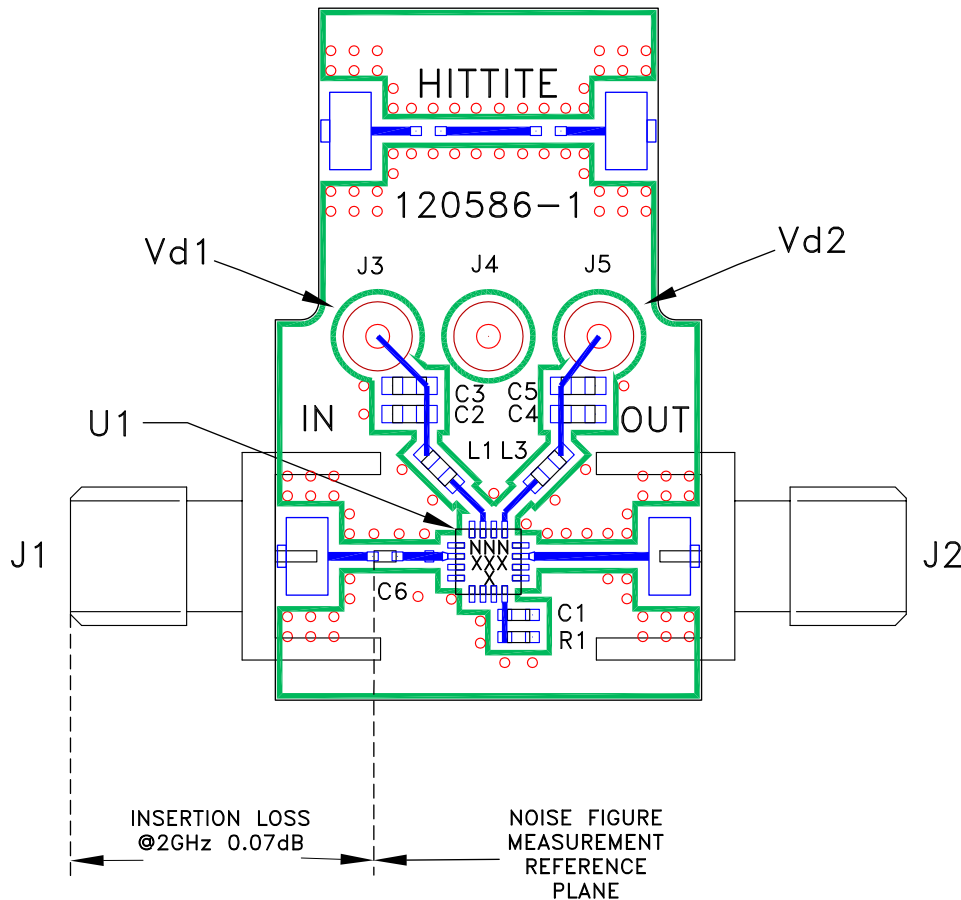

Evaluation PCB Ordering Information

Item	Content	Part Number
Evaluation PCB	HMC618ALP3E Evaluation PCB	EV2HMC618ALP3

The circuit board used in this application should use RF circuit design techniques. Signal lines should have 50 Ohm impedance while the package ground leads and exposed paddle should be connected directly to the ground plane similar to that shown. A sufficient number of via holes should be used to connect the top and bottom ground planes. The evaluation board should be mounted to an appropriate heat sink. The evaluation circuit board shown is available from Analog Devices, upon request.

List of Materials for Evaluation PCB

Item	Description
J1, J2	PCB Mount SMA RF Connector
J3 - J5	DC Pin
C2, C4	1000 pF Capacitor, 0603 Pkg..
C3, C5	0.47 μ F Capacitor, Tantalum
L1	15 nH, Inductor, 0603 Pkg.
L3	6.8 nH, Inductor, 0603 Pkg.
C6	220 pF Capacitor, 0402 Pkg.
C1	10 nF Capacitor, 0402 Pkg.
R1	470 Ohm resistor, 0402 Pkg.
U1	HMC618LP3(E) Amplifier
PCB [2]	120586 Evaluation PCB

[1] Reference this number when ordering complete evaluation PCB

**GaAs SMT pHEMT LOW NOISE
AMPLIFIER, 1.2 - 2.2 GHz**

Application Circuit, 1200 to 1700 MHz Tune

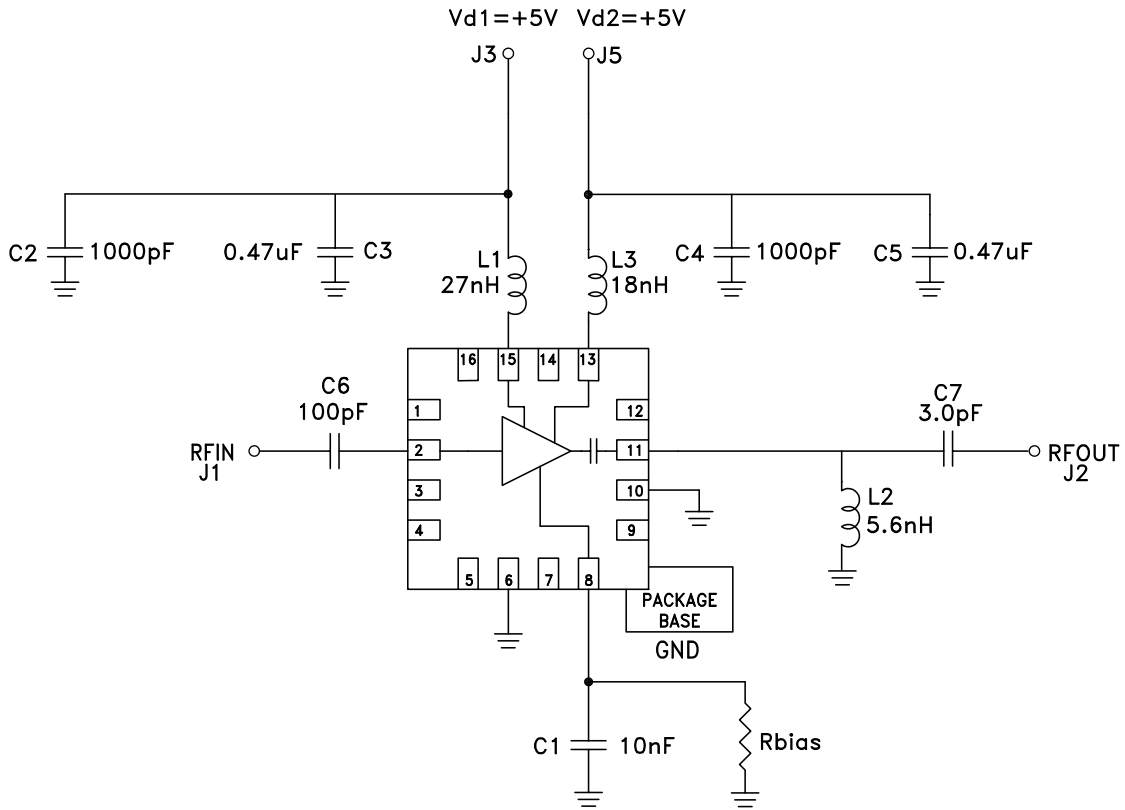

Evaluation PCB, 1200 to 1700 MHz Tune

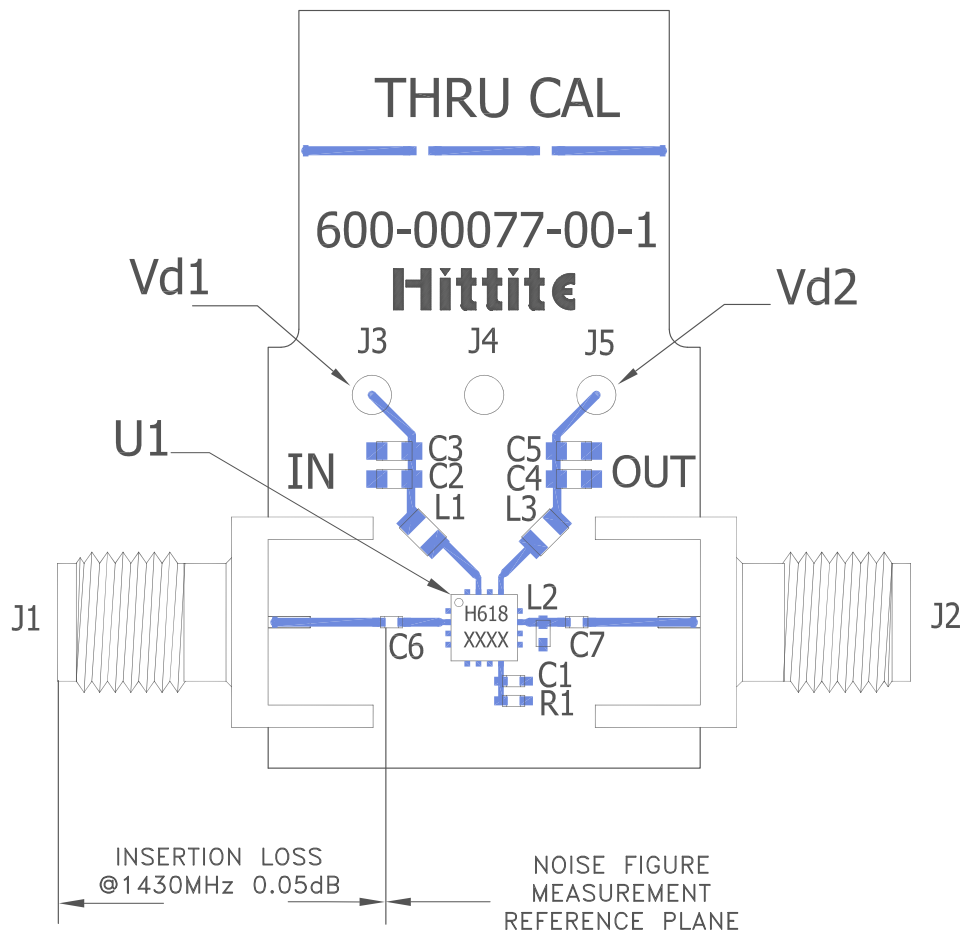

Evaluation PCB Ordering Information

Item	Content	Part Number
Evaluation PCB	HMC618ALP3E Evaluation PCB	EV1HMC618ALP3

The circuit board used in this application should use RF circuit design techniques. Signal lines should have 50 Ohm impedance while the package ground leads and exposed paddle should be connected directly to the ground plane similar to that shown. A sufficient number of via holes should be used to connect the top and bottom ground planes. The evaluation board should be mounted to an appropriate heat sink. The evaluation circuit board shown is available from Analog Devices, upon request.

List of Materials for Evaluation PCB

Item	Description
J1, J2	PCB Mount SMA RF Connector
J3 - J5	DC Pin
C1	10 nF Capacitor, 0402 Pkg.
C2, C4	1000 pF Capacitor, 0603 Pkg..
C3, C5	0.47 μ F Capacitor, 0603 Pkg.
C6	100 pF Capacitor, 0402 Pkg.
C7	3 pF Capacitor, 0402 Pkg.
L1	27 nH, Inductor, 0603 Pkg.
L2	5.6 nH, Inductor, 0603 Pkg.
L3	18 nH, Inductor, 0603 Pkg.
R1	470 Ohm resistor, 0402 Pkg.
U1	HMC618LP3(E) Amplifier
PCB [1]	600-00077-00 Evaluation PCB

[1] Circuit Board Material: Rogers 4350.

X-ON Electronics

Largest Supplier of Electrical and Electronic Components

Click to view similar products for [Audio DSPs](#) category:

Click to view products by [Analog Devices](#) manufacturer:

Other Similar products are found below :

[E-TDA7377A](#) [TDA7716N](#) [BR281W31A101V1G](#) [TDA7419N](#) [R3910-CFAB-E1B](#) [HMC474MP86ETR](#) [AMIS30660CANH6G](#)
[MAX9892ERT+T](#) [MAX9892ELTT](#) [SB3229-E1](#) [NJW1157BFC2](#) [SB3231-E1](#) [HMC1022-SX](#) [SA3229-E1-T](#) [LC75056PE-H](#) [TDA7729](#)
[NJW1195AV](#) [CI1103](#) [VS1010D-Q](#) [WM5102ECS/R](#) [100-CG1820](#) [CS48L10-CNZ](#) [CS48L10-CNZR](#) [CS47024C-CQZ](#) [CS48L10-CWZR](#)
[CS48L11-CNZ](#) [HMC604LP3ETR](#) [HMC5622LS7TR](#) [HMC288MS8ETR](#) [HMC240A](#) [STA323W13TR](#) [BU9408KS2](#) [TAS3204PAGR](#)
[ADAU1463WBCPZ300](#) [BD37514FS-E2](#) [ADAU1463WBCPZ150](#) [NJM2294V-TE1](#) [LC823450TA-2H](#) [NJM2537V-TE1](#) [TWL1103TPBSQ1](#)
[LC823450XDTBG](#) [HMC-AUH312-SX](#) [ADAV4622BSTZ](#) [CMX148Q3](#) [ADXL372BCCZ-RL7](#) [AD1895AYRSZ](#) [AD1940YSTZ](#)
[AD1941YSTZ](#) [AD1954YSTZ](#) [ADAU1452WBCPZ-RL](#)