



## HIGH IP<sub>3</sub>, LOW NOISE AMPLIFIER, 0.2 - 4.0 GHz

### Typical Applications

The HMC639ST89(E) is ideal for:

- Cellular / PCS / 3G
- WiMAX, WiBro, & Fixed Wireless
- CATV & Cable Modem
- Microwave Radio
- IF and RF Sections

### Features

- Low Noise Figure: 2.3 dB
- High P<sub>1dB</sub> Output Power: +22 dBm
- High Output IP<sub>3</sub>: +38 dBm
- Gain: 13 dB
- 50 Ohm I/O's - No External Matching
- Industry Standard SOT89 Package

### Functional Diagram

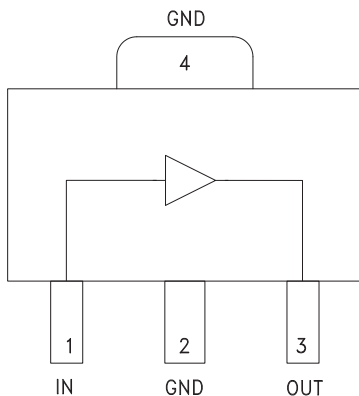

### General Description

The HMC639ST89(E) is a GaAs pHEMT, High Linearity, Low Noise, Wideband Gain Block Amplifier covering 0.2 to 4.0 GHz. Packaged in an industry standard SOT89, the amplifier can be used as either a cascadable 50 Ohm gain stage, a PA Pre-Driver, a Low Noise Amplifier, or a Gain Block with up to +22 dBm output power. This versatile Gain Block Amplifier is powered from a single +5V supply and requires no external matching components. The internally matched topology permits this amplifier to be readily ported between virtually any printed circuit board material, regardless of its dielectric constant, thickness, or composition.

### Electrical Specifications, $V_s = 5V$ , $T_A = +25^\circ C$

Parameter	Min	Typ.	Max	Min.	Typ.	Max.	Units
Frequency Range	0.7 - 2.2			0.2 - 4.0			GHz
Gain	10	13		6	10		dB
Gain Variation Over Temperature		0.01	0.02		0.01	0.02	dB/ °C
Input Return Loss		12			12		dB
Output Return Loss		12			14		dB
Reverse Isolation		20			20		dBm
Output Power for 1 dB Compression (P <sub>1dB</sub> )	19	21		20	22		dB
Output Third Order Intercept (IP <sub>3</sub> )	35	38		35	38		dBm
Noise Figure		2.3			2.5		dB
Supply Current (I <sub>cc</sub> )	90	110	120	90	110	120	mA

Note: Data taken with broadband bias tee on device output.



**HIGH IP3, LOW NOISE  
AMPLIFIER, 0.2 - 4.0 GHz**

**Broadband Gain & Return Loss**

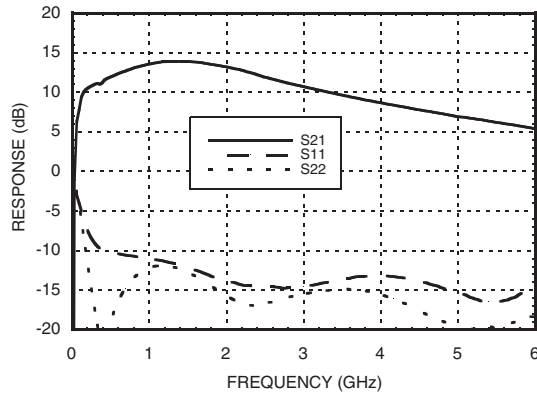

**Gain vs. Temperature**

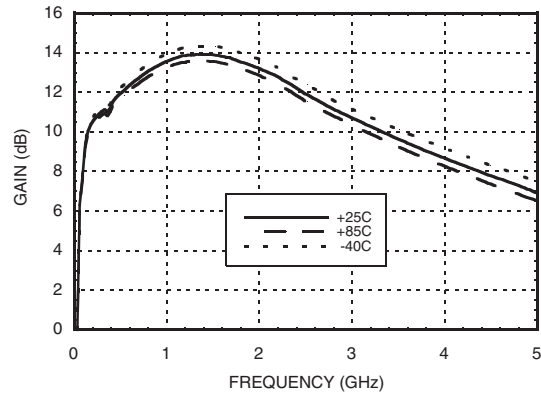

**Input Return Loss vs. Temperature**

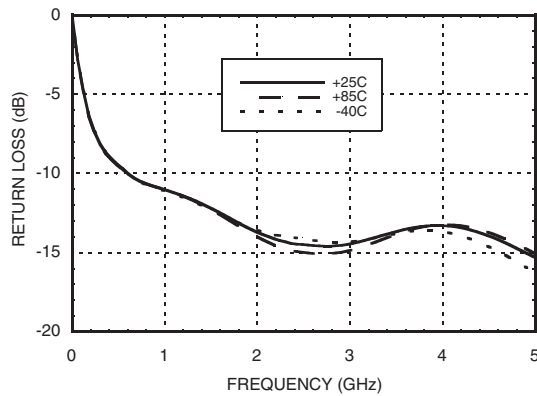

**Output Return Loss vs. Temperature**

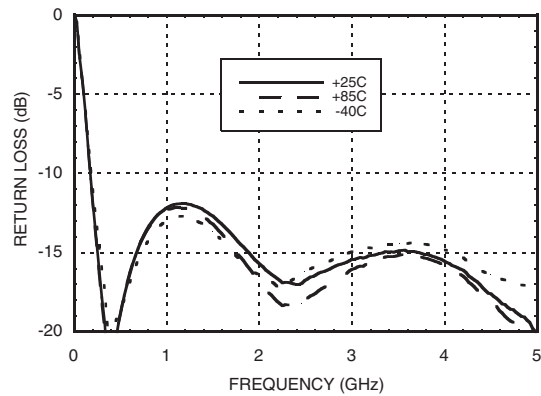

**Reverse Isolation vs. Temperature**

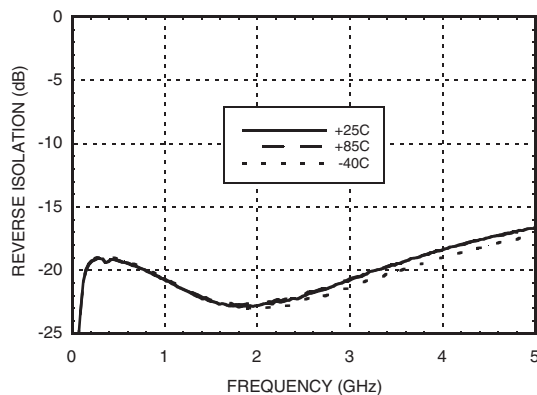

**Noise Figure vs. Temperature**

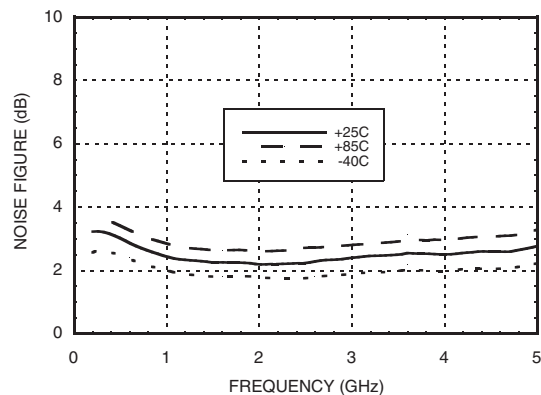

Information furnished by Analog Devices is believed to be accurate and reliable. However, no responsibility is assumed by Analog Devices for its use, nor for any infringements of patents or other rights of third parties that may result from its use. Specifications subject to change without notice. No license is granted by implication or otherwise under any patent or patent rights of Analog Devices. Trademarks and registered trademarks are the property of their respective owners.

For price, delivery, and to place orders: Analog Devices, Inc., One Technology Way, P.O. Box 9106, Norwood, MA 02062-9106 Phone: 781-329-4700 • Order online at [www.analog.com](http://www.analog.com) Application Support: Phone: 1-800-ANALOG-D



**HIGH IP3, LOW NOISE  
AMPLIFIER, 0.2 - 4.0 GHz**

**P1dB vs. Temperature**

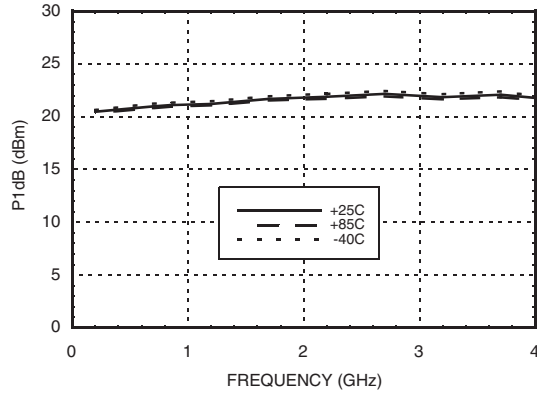

**Psat vs. Temperature**

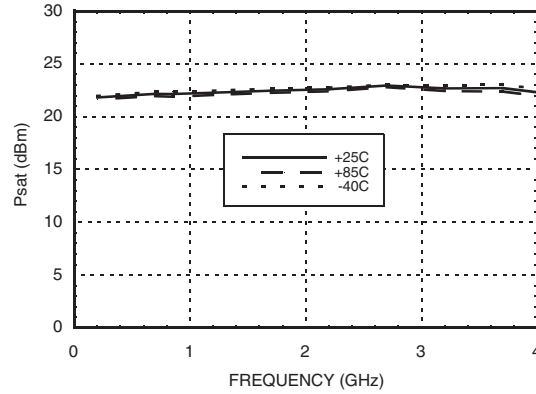

**Power Compression @ 850 MHz**

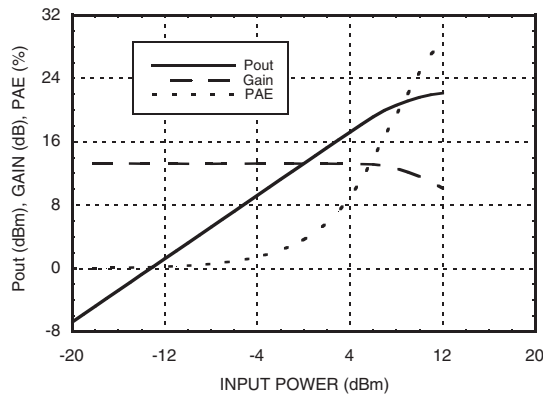

**Power Compression @ 2200 MHz**

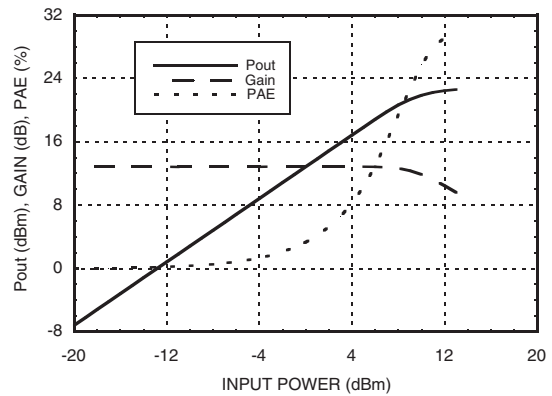

**Output IP3 vs. Output Tone Power**

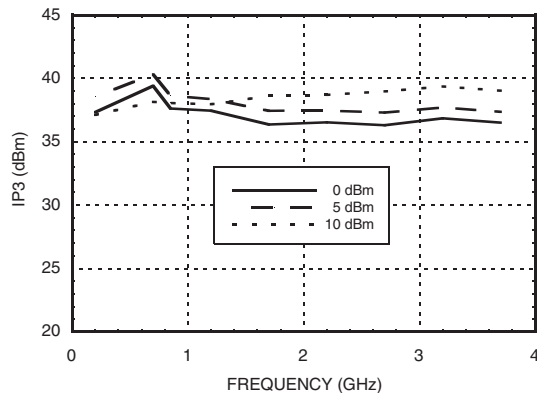

**Gain, Power, Output IP3 & Supply Current vs. Supply Voltage @ 850 MHz**

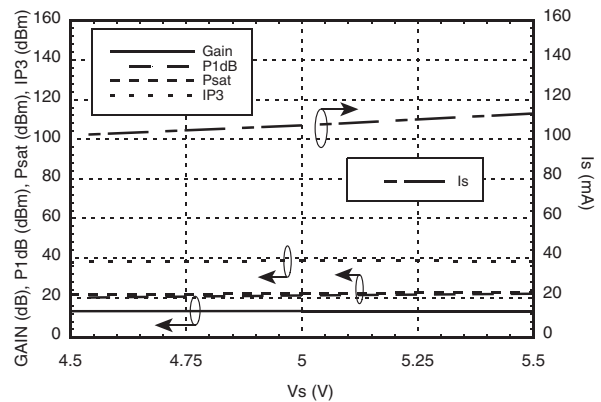



### Absolute Maximum Ratings

Collector Bias Voltage (Vcc)	+5.5 Volts
RF Input Power (RFIN)(Vcc = +5 Vdc)	+15 dBm
Channel Temperature	150 °C
Continuous Pdiss (T = 85 °C) (derate 13.3 mW/°C above 85 °C)	0.86 W
Thermal Resistance (Channel to lead)	75.6 °C/W
Storage Temperature	-65 to +150 °C
Operating Temperature	-40 to +85 °C
ESD Sensitivity (HBM)	Class 1A



ELECTROSTATIC SENSITIVE DEVICE  
OBSERVE HANDLING PRECAUTIONS

### Outline Drawing

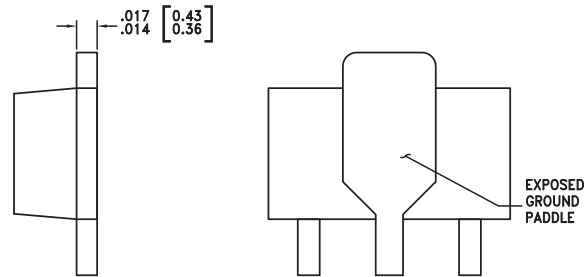
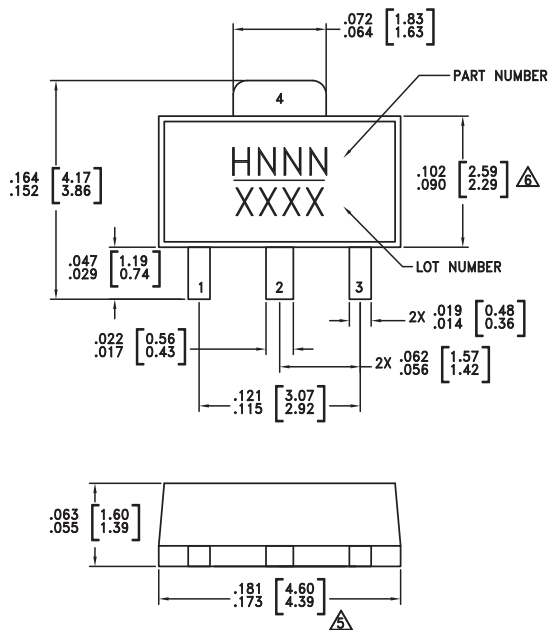

NOTES:

- PACKAGE BODY MATERIAL:  
MOLDING COMPOUND MP-180S OR EQUIVALENT.
- LEAD MATERIAL: Cu w/ Ag SPOT PLATING.
- LEAD PLATING: 100% MATTE TIN.
- DIMENSIONS ARE IN INCHES [MILLIMETERS]
- DIMENSION DOES NOT INCLUDE MOLDFLASH OF 0.15mm PER SIDE.
- DIMENSION DOES NOT INCLUDE MOLDFLASH OF 0.25mm PER SIDE.
- ALL GROUND LEADS MUST BE SOLDERED TO PCB RF GROUND.

### Package Information

Part Number	Package Body Material	Lead Finish	MSL Rating	Package Marking <sup>[3]</sup>
HMC639ST89	Low Stress Injection Molded Plastic	Sn/Pb Solder	MSL1 <sup>[1]</sup>	H639 XXXX
HMC639ST89E	RoHS-compliant Low Stress Injection Molded Plastic	100% matte Sn	MSL1 <sup>[2]</sup>	H639 XXXX

[1] Max peak reflow temperature of 235 °C

[2] Max peak reflow temperature of 260 °C



[3] 4-Digit lot number XXXX

Information furnished by Analog Devices is believed to be accurate and reliable. However, no responsibility is assumed by Analog Devices for its use, nor for any infringements of patents or other rights of third parties that may result from its use. Specifications subject to change without notice. No license is granted by implication or otherwise under any patent or patent rights of Analog Devices. Trademarks and registered trademarks are the property of their respective owners.

For price, delivery, and to place orders: Analog Devices, Inc.,  
One Technology Way, P.O. Box 9106, Norwood, MA 02062-9106  
Phone: 781-329-4700 • Order online at [www.analog.com](http://www.analog.com)  
Application Support: Phone: 1-800-ANALOG-D

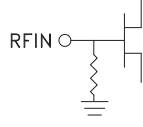
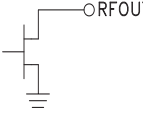

### Pin Descriptions

Pin Number	Function	Description	Interface Schematic
1	RFIN	This pin is DC coupled. An off-chip DC blocking capacitor is required.	
3	RFOUT	RF Output and DC BIAS for the amplifier. See Application Circuit for off-chip components.	
2, 4	GND	These pins and package bottom must be connected to RF/DC ground.	

### Application Circuit

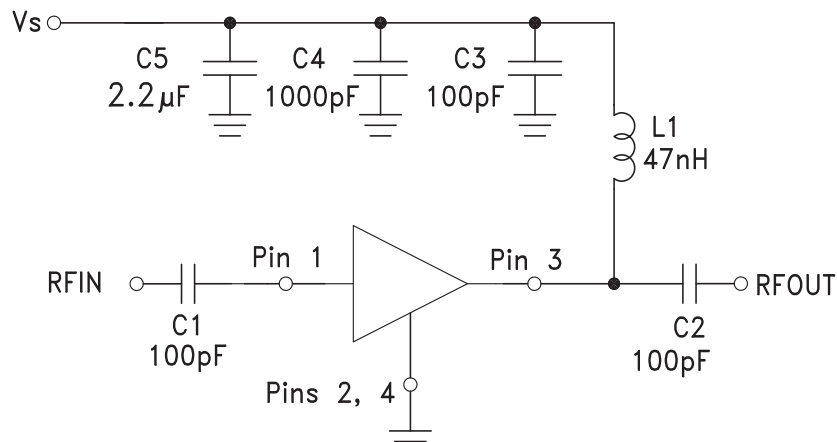

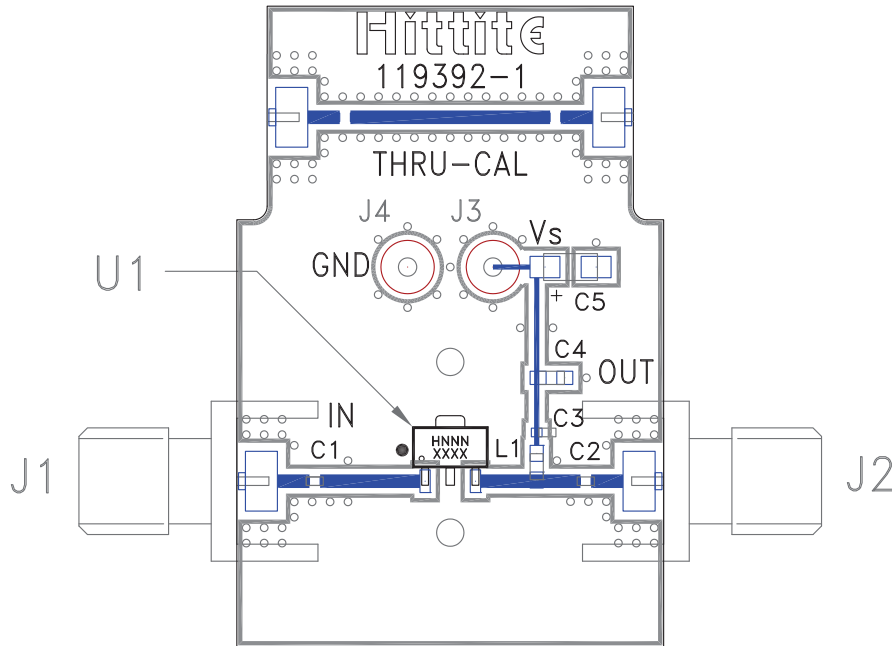
**Evaluation PCB**

**List of Materials for Evaluation PCB 119394 [1]**

Item	Description
J1 - J2	PCB Mount SMA Connector
J3 - J4	DC Pin
C1 - C3	100 pF Capacitor, 0402 Pkg.
C4	1000 pF Capacitor, 0603 Pkg.
C5	2.2 µF Capacitor, Tantalum
L1	47 nH Inductor, 0603 Pkg.
U1	HMC639ST89(E)
PCB [2]	119392 Evaluation PCB

[1] Reference this number when ordering complete evaluation PCB

[2] Circuit Board Material: FR4

The circuit board used in the application should use RF circuit design techniques. Signal lines should have 50 Ohm impedance while the package ground leads and package bottom should be connected directly to the ground plane similar to that shown. A sufficient number of via holes should be used to connect the top and bottom ground planes. The evaluation board should be mounted to an appropriate heat sink. The evaluation circuit board shown is available from Hittite upon request.

## X-ON Electronics

Largest Supplier of Electrical and Electronic Components

*Click to view similar products for [RF Amplifier](#) category:*

*Click to view products by [Analog Devices](#) manufacturer:*

Other Similar products are found below :

[A82-1](#) [BGA622H6820XTSA1](#) [BGA 728L7 E6327](#) [BGB719N7ESDE6327XTMA1](#) [HMC397-SX](#) [HMC405](#) [HMC561-SX](#) [HMC8120-SX](#)  
[HMC8121-SX](#) [HMC-ALH382-SX](#) [HMC-ALH476-SX](#) [SE2433T-R](#) [SMA3101-TL-E](#) [SMA39](#) [A66-1](#) [A66-3](#) [A67-1](#) [A81-2](#) [LX5535LQ](#)  
[LX5540LL](#) [MAAM02350](#) [HMC3653LP3BETR](#) [HMC549MS8GETR](#) [HMC-ALH435-SX](#) [SMA101](#) [SMA32](#) [SMA411](#) [SMA531](#)  
[SST12LP19E-QX6E](#) [WPM0510A](#) [HMC5929LS6TR](#) [HMC5879LS7TR](#) [HMC1087F10](#) [HMC1086](#) [HMC1016](#) [SMA1212](#) [MAX2689EWS+T](#)  
[MAAMSS0041TR](#) [MAAM37000-A1G](#) [LTC6430AIUF-15#PBF](#) [SMA70-2](#) [SMA4011](#) [A231](#) [HMC-AUH232](#) [LX5511LQ](#) [LX5511LQ-TR](#)  
[HMC7441-SX](#) [HMC-ALH310](#) [XD1001-BD-000V](#) [A4011](#)