



## GaAs MMIC 6-BIT DIGITAL PHASE SHIFTER, 3 - 6 GHz

### Typical Applications

The HMC649ALP6E is ideal for:

- EW Receivers
- Weather & Military Radar
- Satellite Communications
- Beamforming Modules
- Phase Cancellation

### Features

- Low RMS Phase Error: 4°
- Low Insertion Loss: 8 dB
- High Linearity: +40 dBm
- Positive Control Logic
- 360° Coverage, LSB = 5.625°
- 28 Lead QFN Leadless SMT Package: 36mm<sup>2</sup>

### Functional Diagram

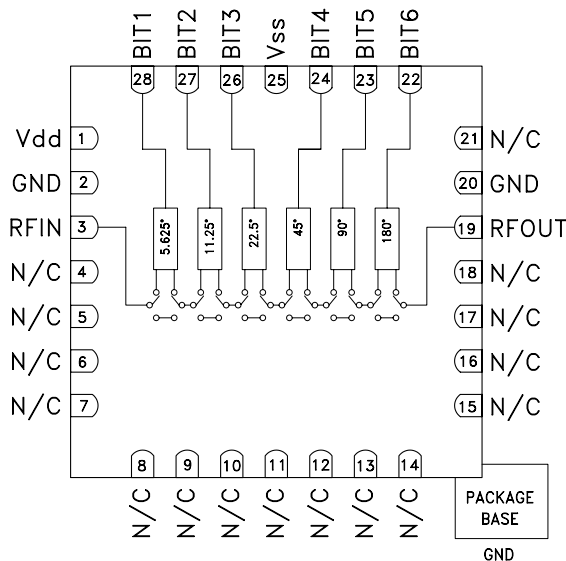

### General Description

The HMC649ALP6E is a 6-bit digital phase shifter which is rated from 3 to 6 GHz, providing 360 degrees of phase coverage, with a LSB of 5.625 degrees. The HMC649ALP6E features very low RMS phase error of 4 degrees and extremely low insertion loss variation of ±0.5 dB across all phase states. This high accuracy phase shifter is controlled with positive control logic of 0/+5V. The HMC649ALP6E is housed in a compact 6x6 mm plastic leadless SMT package and is internally matched to 50 Ohms with no external components.

### Electrical Specifications

$T_A = +25^\circ\text{C}$ ,  $V_{SS} = -5\text{V}$ ,  $V_{DD} = +5\text{V}$ , control Voltage = 0/ +5V, 50 Ohm System

Parameter	Min.	Typ.	Max.	Units
Frequency Range	3		6	GHz
Insertion Loss*		8	10.5	dB
Input Return Loss*		13		dB
Output Return Loss*		10		dB
Phase Error*	3.0 - 5.5 GHz 5.5 - 6.0 GHz	±5 -10	+15 / -25 +15 / -32	deg
RMS Phase Error		4		deg
Insertion Loss Variation*		±0.5		dB
Input Power for 1 dB Compression		31		dBm
Input Third Order Intercept		40		dBm
Control Voltage Current		35	250	µA
Bias Control Current		5	15	mA

\*Note: Major State Change

Information furnished by Analog Devices is believed to be accurate and reliable. However, no responsibility is assumed by Analog Devices for its use, nor for any infringements of patents or other rights of third parties that may result from its use. Specifications subject to change without notice. No license is granted by implication or otherwise under any patent or patent rights of Analog Devices. Trademarks and registered trademarks are the property of their respective owners.

For price, delivery, and to place orders: Analog Devices, Inc., One Technology Way, P.O. Box 9106, Norwood, MA 02062-9106  
Phone: 781-329-4700 • Order online at [www.analog.com](http://www.analog.com)  
Application Support: Phone: 1-800-ANALOG-D



**GaAs MMIC 6-BIT DIGITAL  
PHASE SHIFTER, 3 - 6 GHz**

**Insertion Loss, Major States Only**

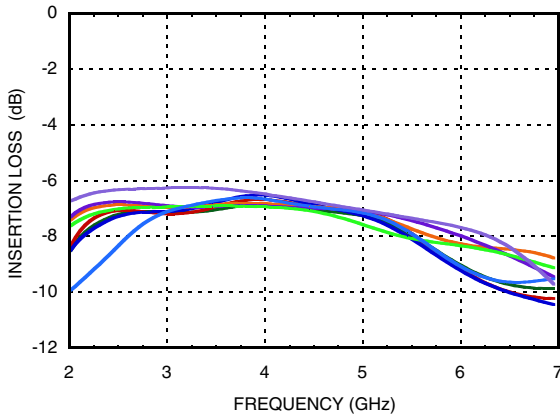

**Normalized Loss, Major States Only**

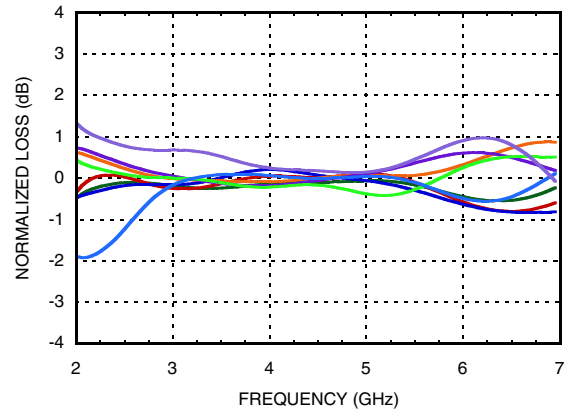

**Input Return Loss, Major States Only**

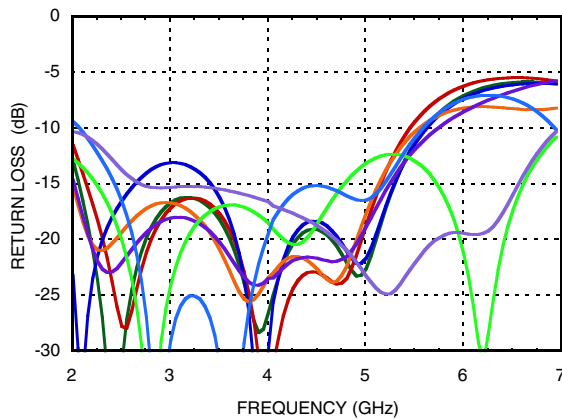

**Phase Error, Major States Only**

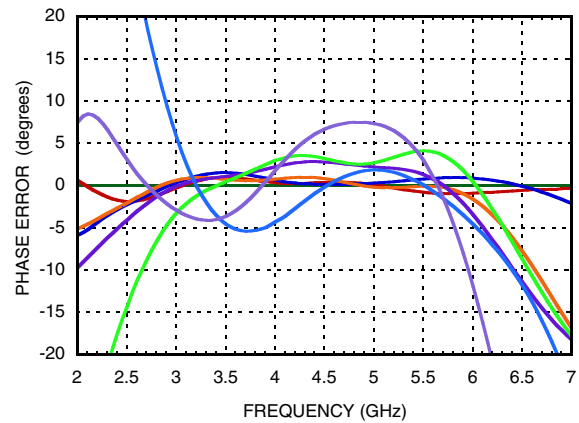

**Output Return Loss, Major States Only**

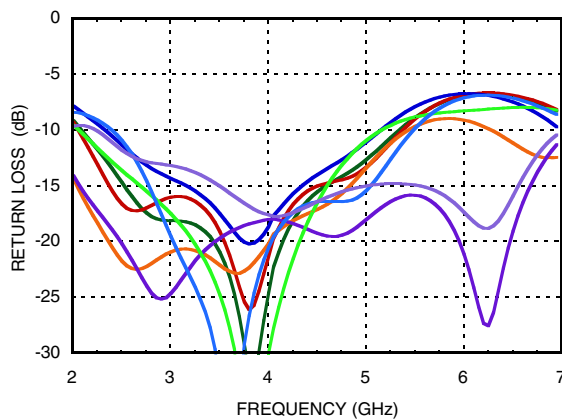

**Relative Phase Shift  
Major States Including All Bits**

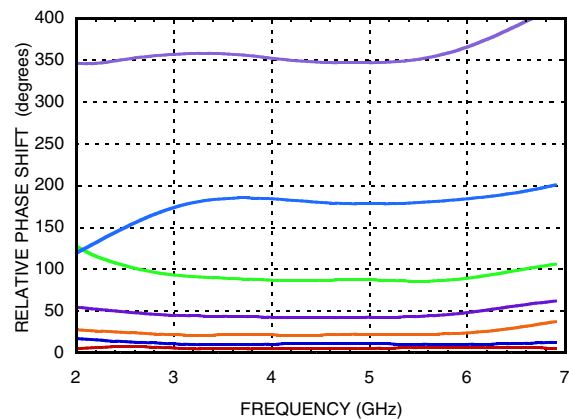

Information furnished by Analog Devices is believed to be accurate and reliable. However, no responsibility is assumed by Analog Devices for its use, nor for any infringements of patents or other rights of third parties that may result from its use. Specifications subject to change without notice. No license is granted by implication or otherwise under any patent or patent rights of Analog Devices. Trademarks and registered trademarks are the property of their respective owners.

For price, delivery, and to place orders: Analog Devices, Inc., One Technology Way, P.O. Box 9106, Norwood, MA 02062-9106 Phone: 781-329-4700 • Order online at [www.analog.com](http://www.analog.com) Application Support: Phone: 1-800-ANALOG-D

**GaAs MMIC 6-BIT DIGITAL  
PHASE SHIFTER, 3 - 6 GHz**



**Relative Phase Shift,  
RMS, Average, Max, All States**

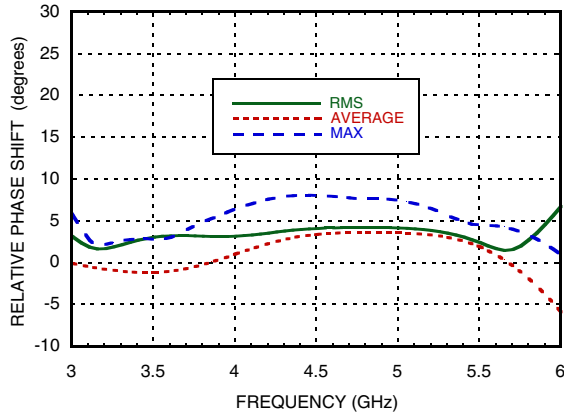

**Input IP3, Major States Only**

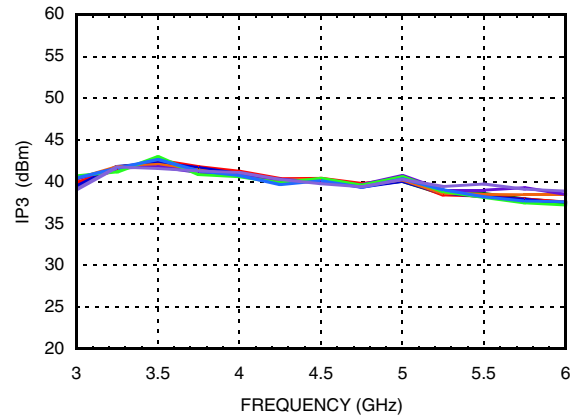

**Input IP2, Major States Only**

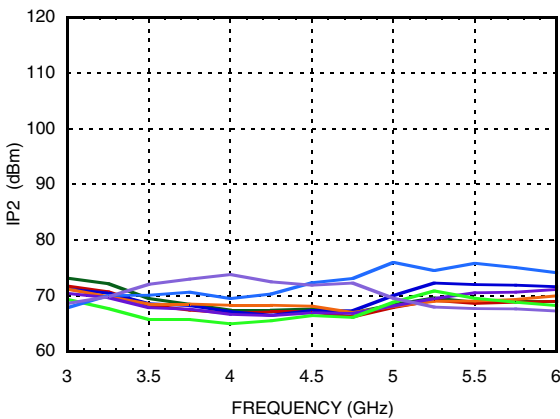

**Input P1dB, Major States Only**

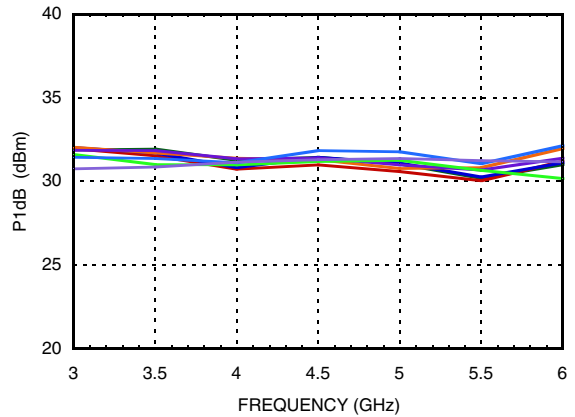

**RMS Phase Error vs. Temperature**

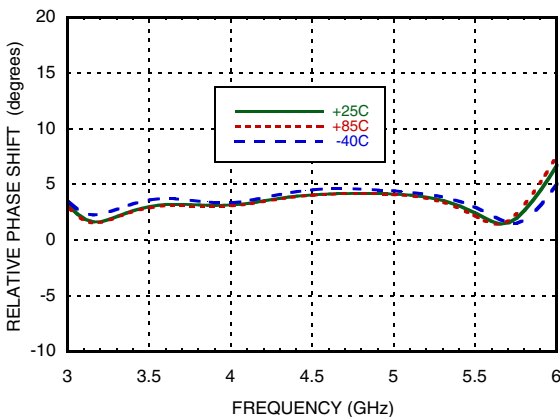

**Insertion Loss vs. Temperature,  
Major States Only**

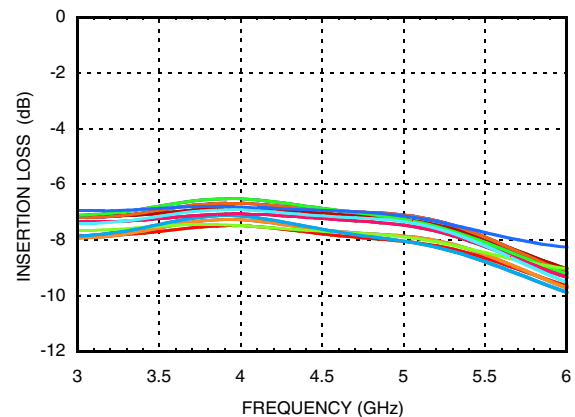

Information furnished by Analog Devices is believed to be accurate and reliable. However, no responsibility is assumed by Analog Devices for its use, nor for any infringements of patents or other rights of third parties that may result from its use. Specifications subject to change without notice. No license is granted by implication or otherwise under any patent or patent rights of Analog Devices. Trademarks and registered trademarks are the property of their respective owners.

For price, delivery, and to place orders: Analog Devices, Inc., One Technology Way, P.O. Box 9106, Norwood, MA 02062-9106 Phone: 781-329-4700 • Order online at [www.analog.com](http://www.analog.com) Application Support: Phone: 1-800-ANALOG-D

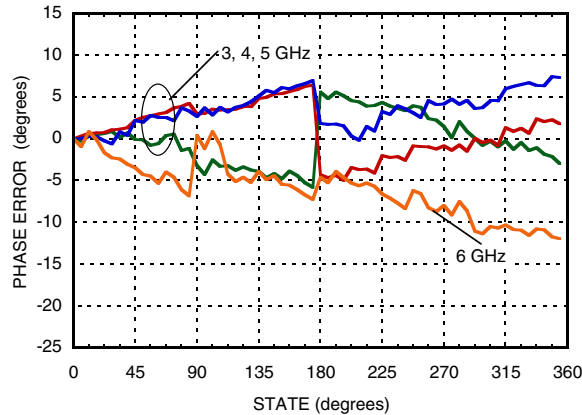
**GaAs MMIC 6-BIT DIGITAL  
PHASE SHIFTER, 3 - 6 GHz**
**Phase Error vs. State**

**Bias Voltage & Current**

Vdd	Idd
5.0	5.4mA
Vss	Iss
-5.0	5.4mA

**Control Voltage**

State	Bias Condition
Low (0)	0 to 0.2 Vdc
High (1)	Vdd ±0.2 Vdc @ 35 µA Typ.

**Absolute Maximum Ratings**

Input Power (RFIN)	32 dBm (T= +85 °C)
Bias Voltage Range (Vdd)	-0.2 to +12V
Bias Voltage Range (Vss)	+0.2 to -12V
Channel Temperature (Tc)	150 °C
Thermal Resistance (channel to ground paddle)	200 °C/W
Storage Temperature	-65 to +150 °C
Operating Temperature	-40 to +85 °C
ESD Sensitivity (HBM)	Class1A (Passed 250V)

**ELECTROSTATIC SENSITIVE DEVICE  
OBSERVE HANDLING PRECAUTIONS**
**Truth Table**

Control Voltage Input						Phase Shift (Degrees) RFIN - RFOUT
Bit 1	Bit 2	Bit 3	Bit 4	Bit 5	Bit 6	
0	0	0	0	0	0	Reference*
1	0	0	0	0	0	5.625
0	1	0	0	0	0	11.25
0	0	1	0	0	0	22.5
0	0	0	1	0	0	45.0
0	0	0	0	1	0	90.0
0	0	0	0	0	1	180.0
1	1	1	1	1	1	354.375

Any combination of the above states will provide a phase shift approximately equal to the sum of the bits selected.  
\*Reference corresponds to monotonic setting



## GaAs MMIC 6-BIT DIGITAL PHASE SHIFTER, 3 - 6 GHz

### Outline Drawing

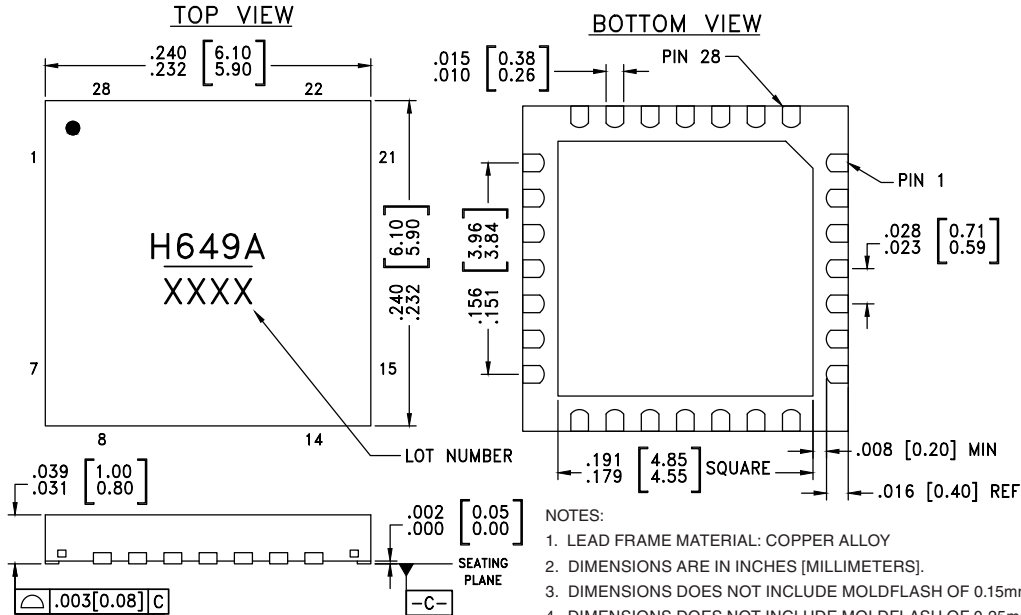

### Package Information

Part Number	Package Body Material	Lead Finish	MSL Rating	Package Marking <sup>[2]</sup>
HMC649ALP6E	RoHS-compliant Low Stress Injection Molded Plastic	100% matte Sn	MSL3 <sup>[1]</sup>	H649A XXXX

[1] Max peak reflow temperature of 260 °C

[2] 4-Digit lot number XXXX

### Pin Descriptions

Pin Number	Function	Description	Interface Schematic
1	Vdd	Voltage Supply	
2, 20	GND	These pins and exposed ground paddle must be connected to RF/DC ground.	
3	RFIN	This port is DC coupled and matched to 50 Ohms.	
4 - 18, 21	N/C	No connection required. These pins may be connected to RF/DC ground without affecting performance.	
19	RFOUT	This port is DC coupled and matched to 50 Ohms.	
22 - 24 26 - 28	BIT6, BIT5, BIT4, BIT3, BIT2, BIT1	Control Input. See truth table and control voltage tables.	
25	Vss	Voltage Supply	

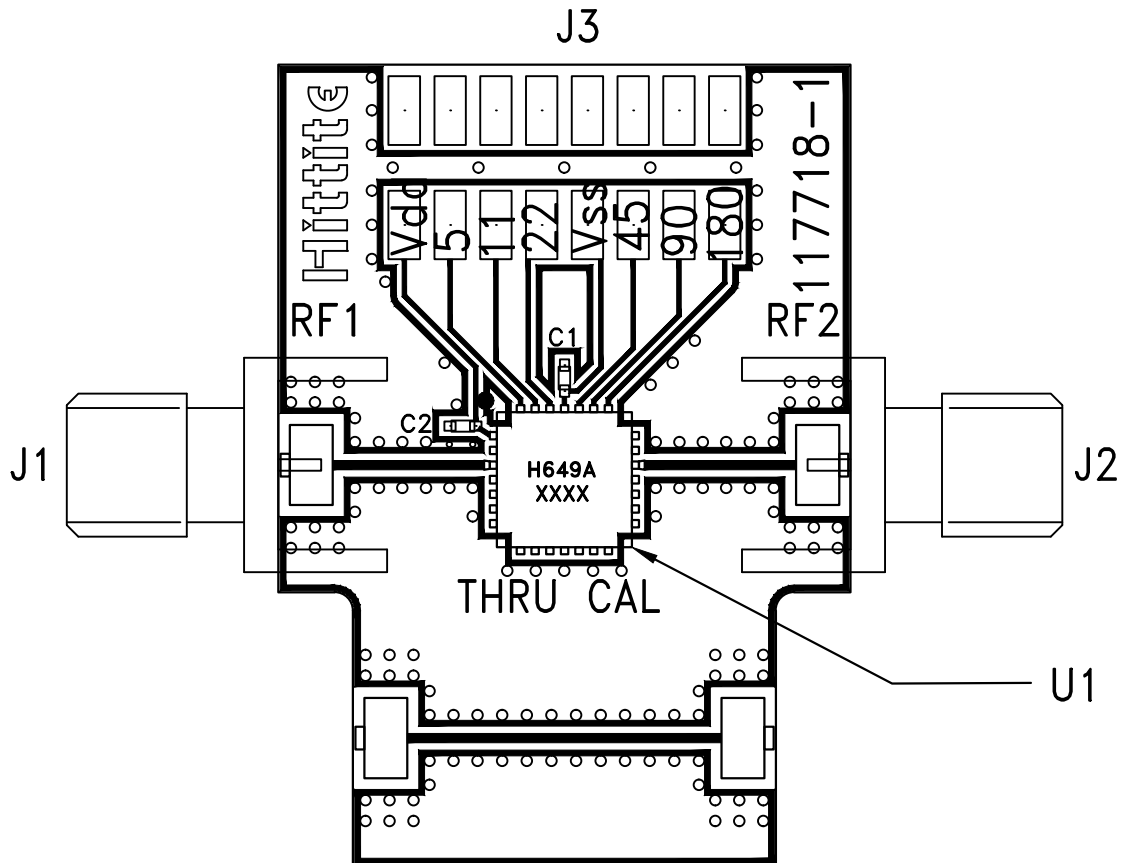
**GaAs MMIC 6-BIT DIGITAL  
PHASE SHIFTER, 3 - 6 GHz**
**Evaluation PCB**

**List of Materials for Evaluation PCB EV1HMC649ALP5 <sup>[1][3]</sup>**

Item	Description
J1 - J2	PCB Mount SMA RF Connector
J3	Header 2mm, 16 pins
C1, C2	1000pF, 0402 pkg
U1	HMC649ALP6E 6-Bit Digital Phase Shifter
PCB [2]	117718 Evaluation PCB

[1] Reference this number when ordering complete evaluation PCB

[2] Circuit Board Material: Rogers 4350

[3] Please refer to part's pin description and functional diagram for pin out assignments on evaluation board.

The circuit board used in the final application should use RF circuit design techniques. Signal lines should have 50 ohm impedance while the package ground leads and exposed paddle should be connected directly to the ground plane similar to that shown. A sufficient number of via holes should be used to connect the top and bottom ground planes. The evaluation board should be mounted to an appropriate heat sink. The evaluation circuit board shown is available from Hittite upon request.

## X-ON Electronics

Largest Supplier of Electrical and Electronic Components

*Click to view similar products for [Phase Detectors/Shifters](#) category:*

*Click to view products by [Analog Devices](#) manufacturer:*

Other Similar products are found below :

[MAPS-010163-TR1000](#) [HMC1133LP5E](#) [HMC247-SX](#) [HMC3716LP4E](#) [HMC543ALC4B](#) [HMC642ALC5](#) [HMC647ALP6E](#) [HMC648ALP6E](#)  
[HMC936ALP6E](#) [HMC984LP4E](#) [MAPS-010163-001SMB](#) [MAPS-010163-TR0500](#) [MAPS-010164-TR0500](#) [HMC649ALP6E](#) [MAPS-010165-TR0500](#) [HMC649ALP6ETR](#) [CHP3015-QDG](#) [TGP2107](#) [TGP2109](#) [TGP2109-SM](#)