



**GaAs PHEMT MMIC LNA w/
FAILSAFE BYPASS MODE, 700 - 1200 MHz**

Typical Applications

- The HMC668LP3(E) is ideal for:
- Cellular/3G and LTE/WiMAX/4G
 - BTS & Infrastructure
 - Repeaters and Femtocells
 - Tower Mounted Amplifiers
 - Test & Measurement Equipment

Features

- Noise Figure: 0.9 dB
- Output IP3: +33 dBm
- Gain: 16 dB
- Failsafe Operation:
 - Bypass is enabled when LNA is unpowered
- Single Supply: +3V or +5V
- 16 Lead 3x3mm QFN Package: 9 mm²

Functional Diagram

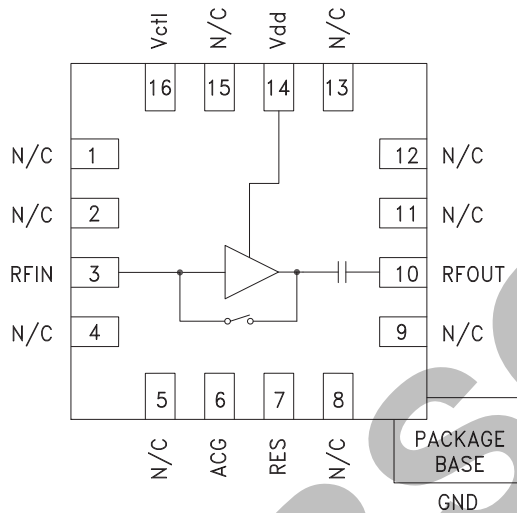

General Description

The HMC668LP3(E) is a versatile, high dynamic range GaAs MMIC Low Noise Amplifier that integrates a low loss LNA bypass mode on the IC. The amplifier is ideal for receivers and LNA modules operating between 0.7 and 1.2 GHz and provides 0.9 dB noise figure, 16 dB of gain and +33 dBm IP3 from a single supply of +5V @ 57mA. Input and output return losses are excellent and no external matching components are required. A single control line is used to switch between LNA mode and a low loss bypass mode. The failsafe topology enables the LNA bypass path, when no DC power is available. The HMC668LP3(E) offers improved noise figure versus the previously released HMC373LP3(E).

Electrical Specifications, $T_A = +25^\circ\text{C}$, $R_{bias} = 0\text{ Ohm}$

| Parameter | LNA Mode | | | | | | Bypass Mode | | | Failsafe Mode | | | Units |
|---|-----------|------|------|-----------|------|------|-------------|------|------|---------------|------|------|---------|
| | Vdd = +3V | | | Vdd = +5V | | | Min. | Typ. | Max. | Min. | Typ. | Max. | |
| | Min. | Typ. | Max. | Min. | Typ. | Max. | | | | | | | |
| Frequency Range | 0.7 - 1.2 | | | 0.7 - 1.2 | | | 0.7 - 1.2 | | | 0.7 - 1.2 | | | GHz |
| Gain | 12 | 15 | | 13 | 16 | | -2.5 | -1.5 | | -2.5 | -1.5 | | dB |
| Gain Variation Over Temperature | 0.03 | | | 0.016 | | | 0.0008 | | | 0.0008 | | | dB / °C |
| Noise Figure | 0.85 | | | 1.1 | | | 0.9 | | | 1.1 | | | dB |
| Input Return Loss | 12 | | | 13 | | | 12 | | | 12 | | | dB |
| Output Return Loss | 13 | | | 14 | | | 13 | | | 13 | | | dB |
| Reverse Isolation | 22 | | | 23 | | | - | | | - | | | dB |
| Power for 1dB Compression (P1dB) ^[1] | 13 | | | 13 | | | 22 | | | 24 | | | dBm |
| Third Order Intercept (IP3) ^[2] | 27 | | | 33 | | | 26 | | | 26 | | | dBm |
| Supply Current (Idd) | 32 | | | 40 | | | 57 | | | 70 | | | mA |
| Switching Speed (90% -10%) | | | | | | | | | | | | | |
| LNA Mode to Bypass Mode | | | | | | | 200 | | | - | | | ns |
| Bypass Mode to LNA Mode | 85 | | | 85 | | | | | | | | | ns |

[1] P1dB for LNA Mode is referenced to RFOUT while P1dB for Bypass and Failsafe Modes are referenced to RFIN.

[2] IP3 for LNA Mode is referenced to RFOUT while IP3 for Bypass and Failsafe Modes are referenced to RFIN.



**GaAs PHEMT MMIC LNA w/
FAILSAFE BYPASS MODE, 700 - 1200 MHz**

LNA - Broadband Gain & Return Loss

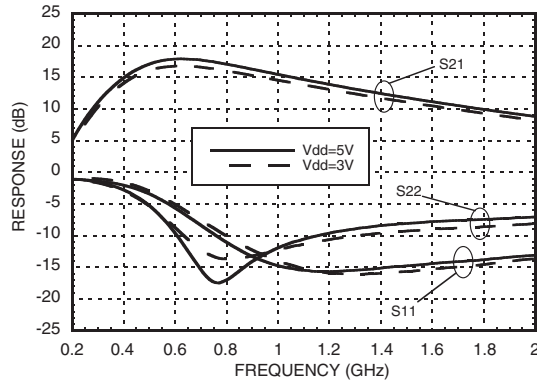

LNA - Gain vs. Temperature ^[1]

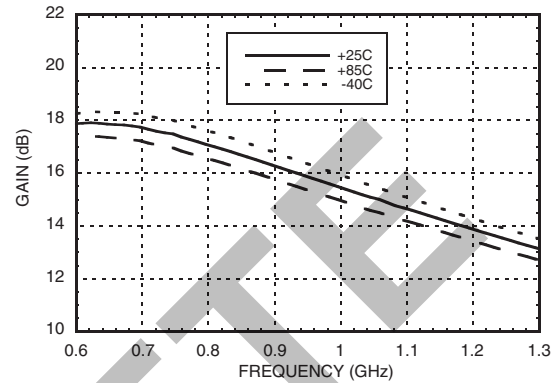

LNA - Gain vs. Temperature ^[2]

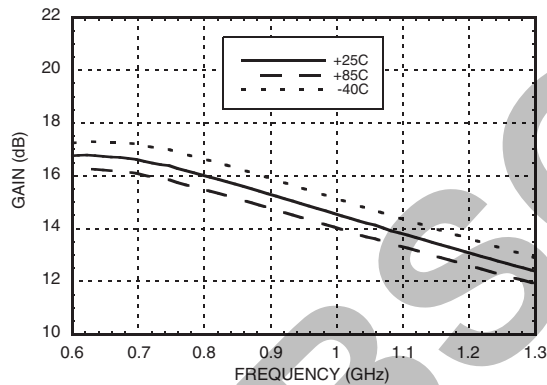

LNA - Return Loss vs. Temperature ^[1]

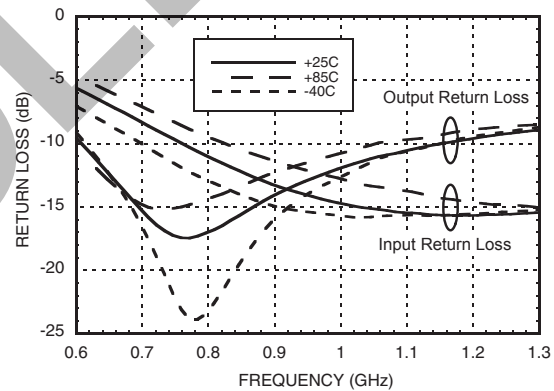

LNA - Noise Figure vs. Temperature ^[3]

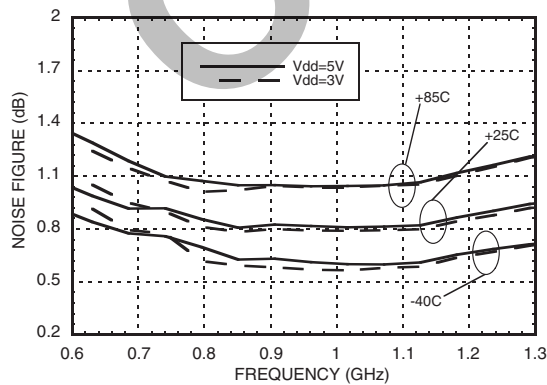

LNA - Output IP3 vs. Temperature, Output Power @ 0 dBm

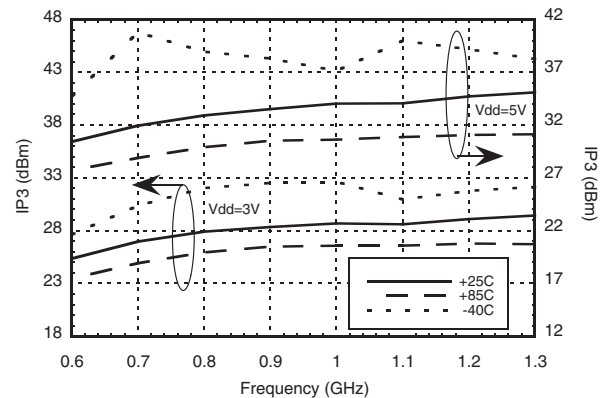

[1] V_{dd} = 5V [2] V_{dd} = 3V [3] Measurement reference plane shown on evaluation PCB drawing.

Information furnished by Analog Devices is believed to be accurate and reliable. However, no responsibility is assumed by Analog Devices for its use, nor for any infringements of patents or other rights of third parties that may result from its use. Specifications subject to change without notice. No license is granted by implication or otherwise under any patent or patent rights of Analog Devices. Trademarks and registered trademarks are the property of their respective owners.

For price, delivery, and to place orders: Analog Devices, Inc., One Technology Way, P.O. Box 9106, Norwood, MA 02062-9106 Phone: 781-329-4700 • Order online at www.analog.com Application Support: Phone: 1-800-ANALOG-D



**GaAs PHEMT MMIC LNA w/
FAILSAFE BYPASS MODE, 700 - 1200 MHz**

LNA - Output P1dB vs. Temperature [1]

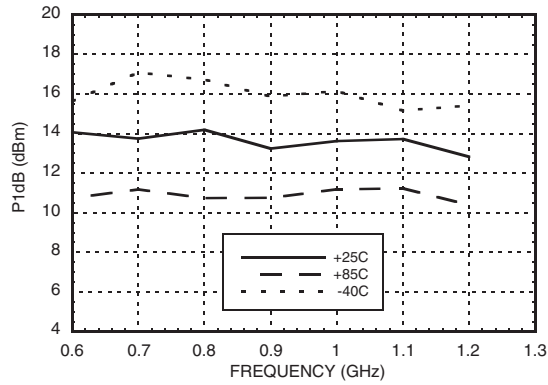

LNA - Output P1dB vs. Temperature [2]

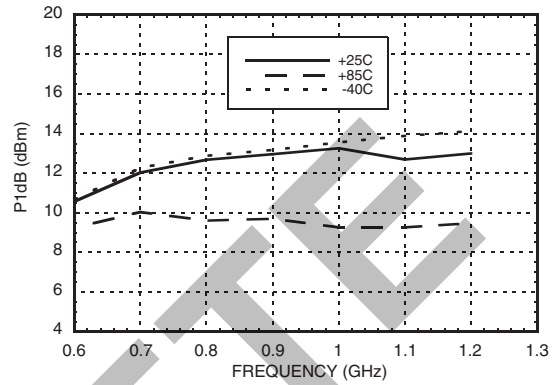

LNA - Gain, P1dB, Output IP3 vs. Current [1] @ 900 MHz

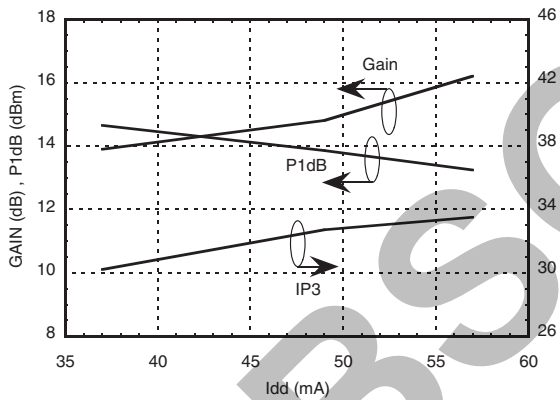

LNA - Gain, P1dB, Output IP3 vs. Current [2] @ 900 MHz

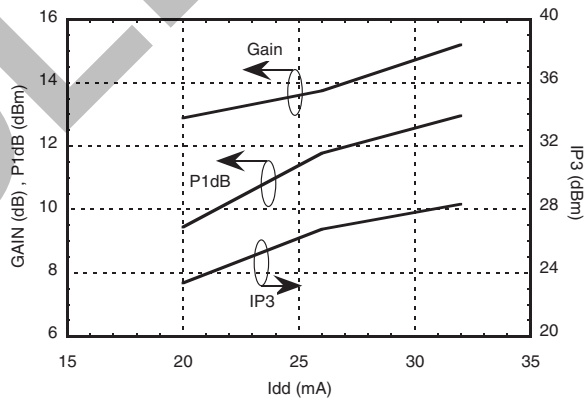

LNA - Reverse Isolation vs. Temperature [1]

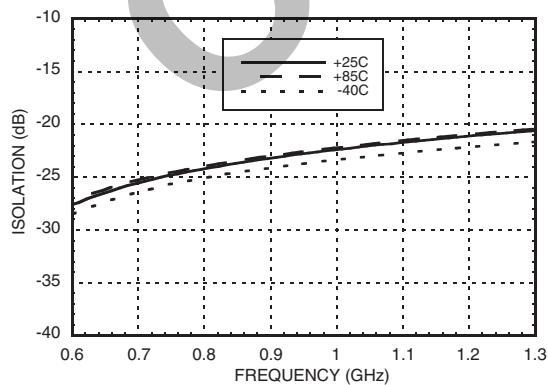

LNA - Output P1dB, Gain & Noise Figure [3] vs. Vdd @ 900 MHz

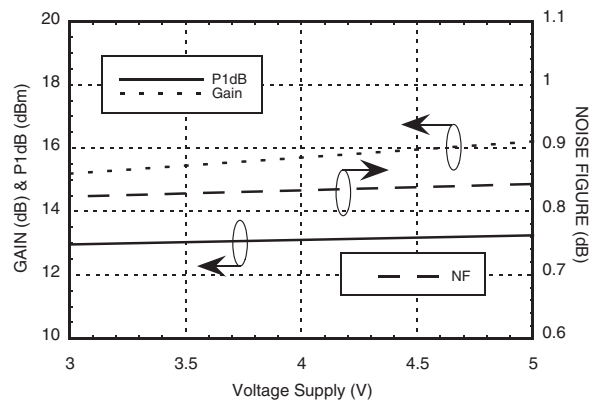

[1] Vdd = 5V [2] Vdd = 3V [3] Measurement reference plane shown on evaluation PCB drawing.

Information furnished by Analog Devices is believed to be accurate and reliable. However, no responsibility is assumed by Analog Devices for its use, nor for any infringements of patents or other rights of third parties that may result from its use. Specifications subject to change without notice. No license is granted by implication or otherwise under any patent or patent rights of Analog Devices. Trademarks and registered trademarks are the property of their respective owners.

For price, delivery, and to place orders: Analog Devices, Inc., One Technology Way, P.O. Box 9106, Norwood, MA 02062-9106 Phone: 781-329-4700 • Order online at www.analog.com Application Support: Phone: 1-800-ANALOG-D

**GaAs PHEMT MMIC LNA w/
FAILSAFE BYPASS MODE, 700 - 1200 MHz**



**Bypass Mode -
Broadband Gain & Return Loss**

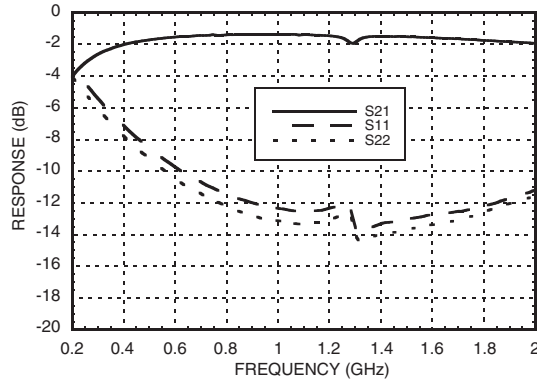

**Bypass Mode -
Input IP3 vs. Output Power @ 900 MHz**

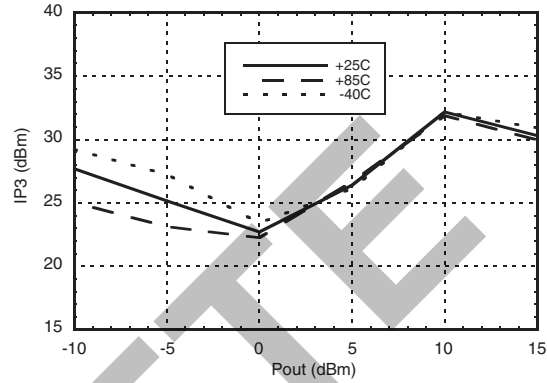

**Bypass Mode - Input IP3 vs. Temperature,
Output Power @ 5 dBm**

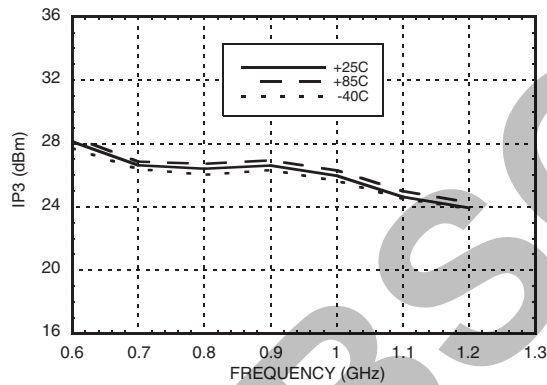

**Bypass Mode -
Insertion Loss vs. Temperature**

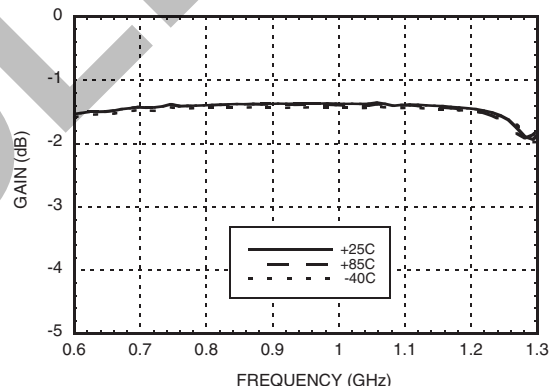

**Bypass Mode -
Input Return Loss vs. Temperature**

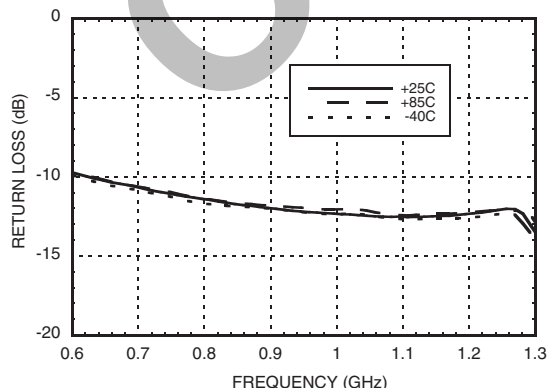

**Bypass Mode -
Output Return Loss vs. Temperature**

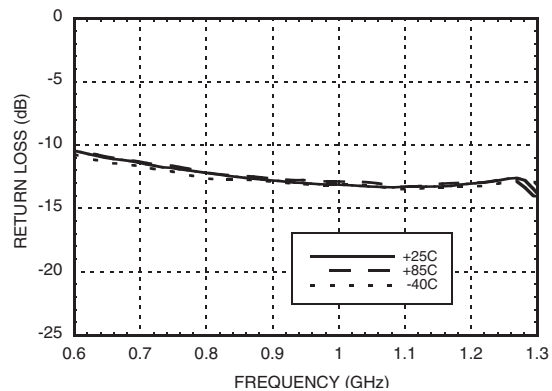

Information furnished by Analog Devices is believed to be accurate and reliable. However, no responsibility is assumed by Analog Devices for its use, nor for any infringements of patents or other rights of third parties that may result from its use. Specifications subject to change without notice. No license is granted by implication or otherwise under any patent or patent rights of Analog Devices. Trademarks and registered trademarks are the property of their respective owners.

For price, delivery, and to place orders: Analog Devices, Inc., One Technology Way, P.O. Box 9106, Norwood, MA 02062-9106 Phone: 781-329-4700 • Order online at www.analog.com Application Support: Phone: 1-800-ANALOG-D



**GaAs PHEMT MMIC LNA w/
FAILSAFE BYPASS MODE, 700 - 1200 MHz**

**Failsafe Mode -
Broadband Gain & Return Loss**

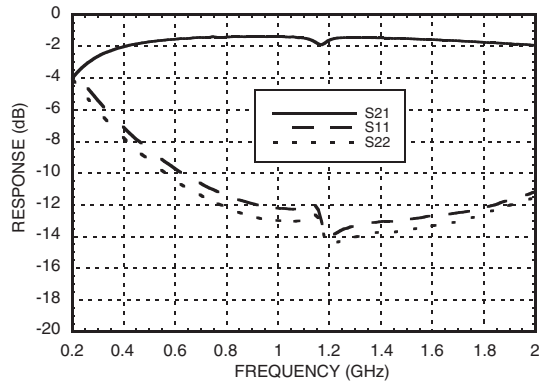

**Failsafe Mode -
Input IP3 vs. Output Power @ 900 MHz**

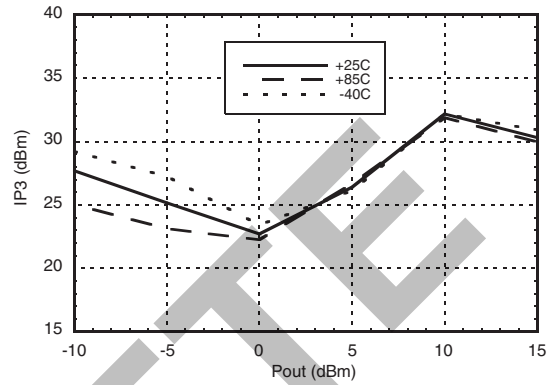

**Failsafe Mode - Input IP3 vs.
Temperature, Output Power @ 5 dBm**

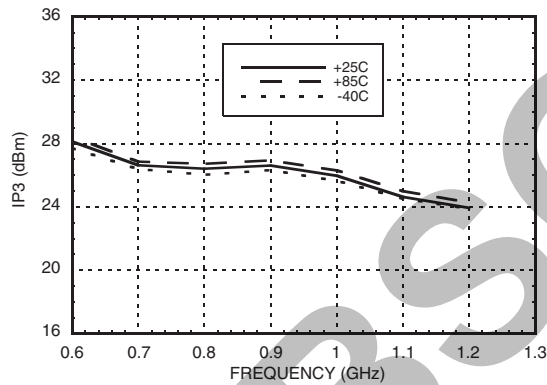

**Failsafe Mode -
Insertion Loss vs. Temperature**

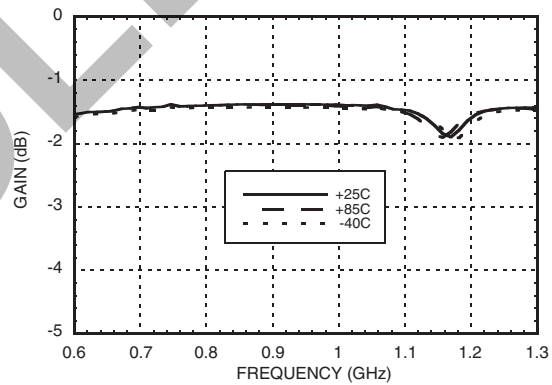

**Failsafe Mode -
Input Return Loss vs. Temperature**

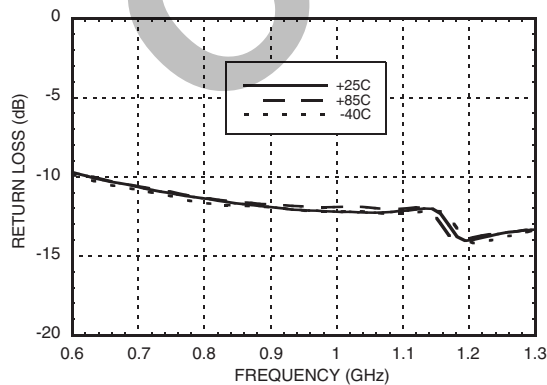

**Failsafe Mode -
Output Return Loss vs. Temperature**

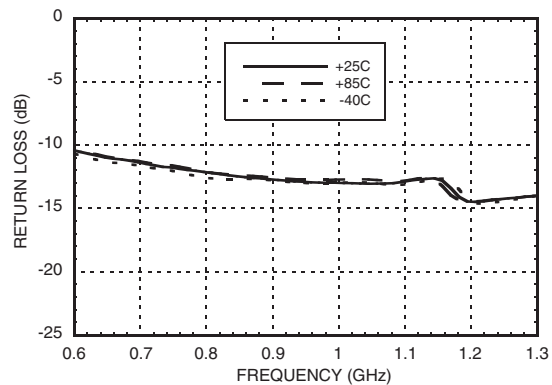

Information furnished by Analog Devices is believed to be accurate and reliable. However, no responsibility is assumed by Analog Devices for its use, nor for any infringements of patents or other rights of third parties that may result from its use. Specifications subject to change without notice. No license is granted by implication or otherwise under any patent or patent rights of Analog Devices. Trademarks and registered trademarks are the property of their respective owners.

For price, delivery, and to place orders: Analog Devices, Inc., One Technology Way, P.O. Box 9106, Norwood, MA 02062-9106 Phone: 781-329-4700 • Order online at www.analog.com Application Support: Phone: 1-800-ANALOG-D

Absolute Maximum Ratings

| | |
|--|---|
| Drain Bias Voltage (Vdd) | +6 Vdc |
| Control Voltage (Vctl) | +6 Vdc |
| RF Input Power (RFIN) | LNA Mode +5 dBm Bypass / Failsafe Mode +20 dBm |
| Channel Temperature | 150 °C |
| Continuous Pdiss (T = 85 °C) (derate 10.71 mW/°C above 85 °C) | 0.70 W |
| Thermal Resistance (channel to ground paddle) | 93.33 °C/W |
| Storage Temperature | -65 to +150° C |
| Operating Temperature | -40 to +85° C |
| ESD Sensitivity (HBM) | Class 1A |



**ELECTROSTATIC SENSITIVE DEVICE
OBSERVE HANDLING PRECAUTIONS**

Typical Supply Current vs. Vdd

| Rbias Ω | Idd (mA) | |
|---------|----------|---------|
| | Vdd= 3V | Vdd= 5V |
| 0 | 32 | 57 |
| 15 | 26 | 49 |
| 47 | 20 | 37 |
| 180 [1] | 10 | 20 |

[1] Recommended maximum Rbias

Truth Table

| | |
|---------------|-------------------------|
| LNA Mode | Vctl = Vdd = 3 to 5V |
| Bypass Mode | Vctl= 0V, Vdd = 3 to 5V |
| Failsafe Mode | Vctl = Vdd = N/C |

OBSOLETE



**GaAs PHEMT MMIC LNA w/
FAILSAFE BYPASS MODE, 700 - 1200 MHz**

Outline Drawing

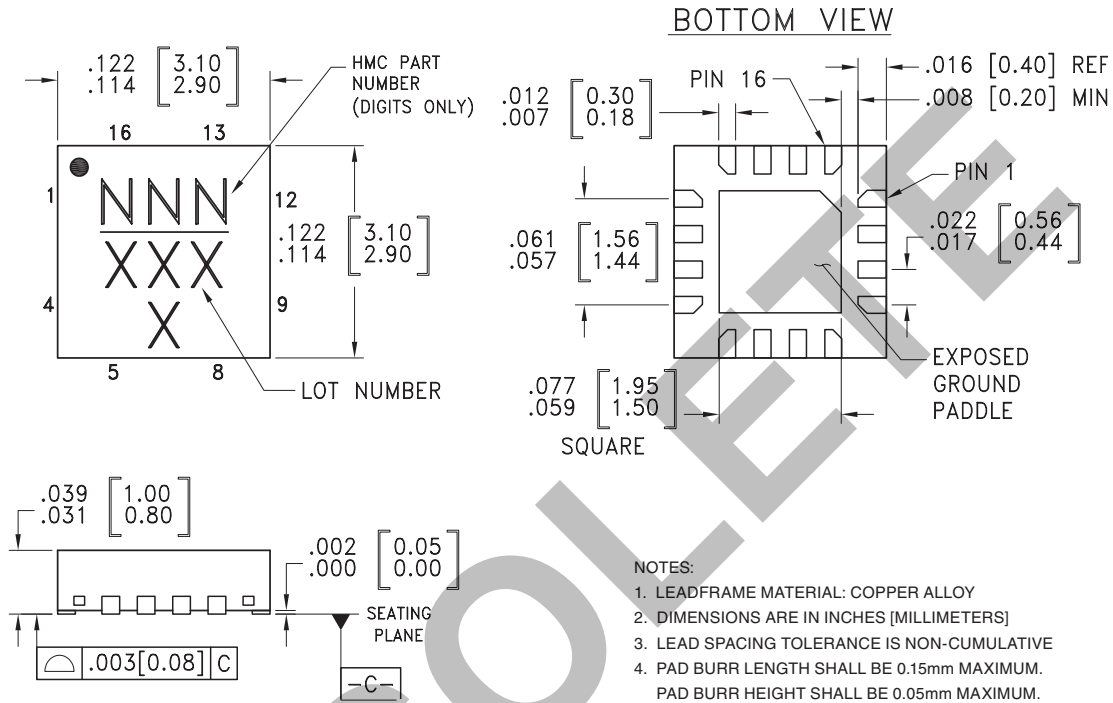

Package Information

| Part Number | Package Body Material | Lead Finish | MSL Rating | Package Marking ^[3] |
|-------------|--|---------------|---------------------|--------------------------------|
| HMC668LP3 | Low Stress Injection Molded Plastic | Sn/Pb Solder | MSL1 ^[1] | 668 XXXX |
| HMC668LP3E | RoHS-compliant Low Stress Injection Molded Plastic | 100% matte Sn | MSL1 ^[2] | 668 XXXX |

[1] Max peak reflow temperature of 235 °C
 [2] Max peak reflow temperature of 260 °C
 [3] 4-Digit lot number XXXX

Pin Descriptions

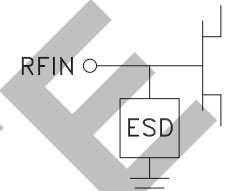
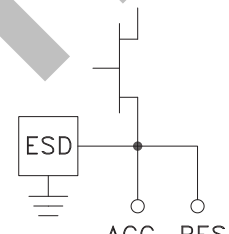
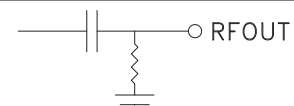
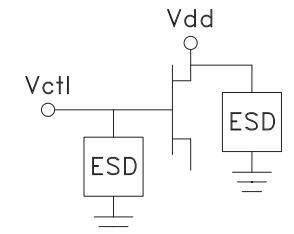
| Pin Number | Function | Description | Interface Schematic |
|----------------------------------|----------|--|---|
| 1, 2, 4, 5, 8, 9, 11, 12, 13, 15 | N/C | No connection required. These pins may be connected to RF GND. Performance will not be affected. | |
| 3 | RFIN | This pin is DC coupled. Off-chip DC blocking capacitor required. |  |
| 6 | ACG | AC Ground. Attach bypass capacitor per application circuit. |  |
| 7 | RES | External resistor pin for current control. See table for external resistor value vs. bias current data. | |
| 10 | RFOUT | This pin is matched to 50 Ohms |  |
| 14 | Vdd | Power Supply voltage pin. External bypass capacitors required. |  |
| 16 | Vctl | Control voltage pin for LNA / Bypass Modes. Setting voltage equal to VDD enables LNA Mode. External Bypass capacitor required. | |



**GaAs PHEMT MMIC LNA w/
FAILSAFE BYPASS MODE, 700 - 1200 MHz**

7

Application Circuit

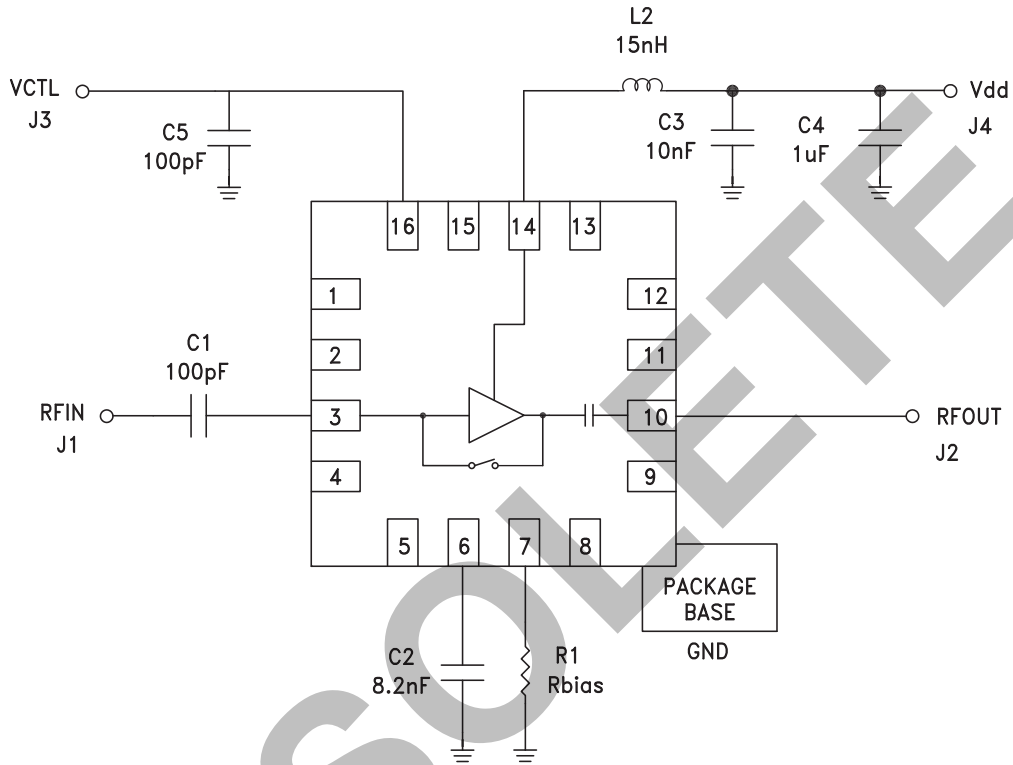

AMPLIFIERS - LOW NOISE - SMT

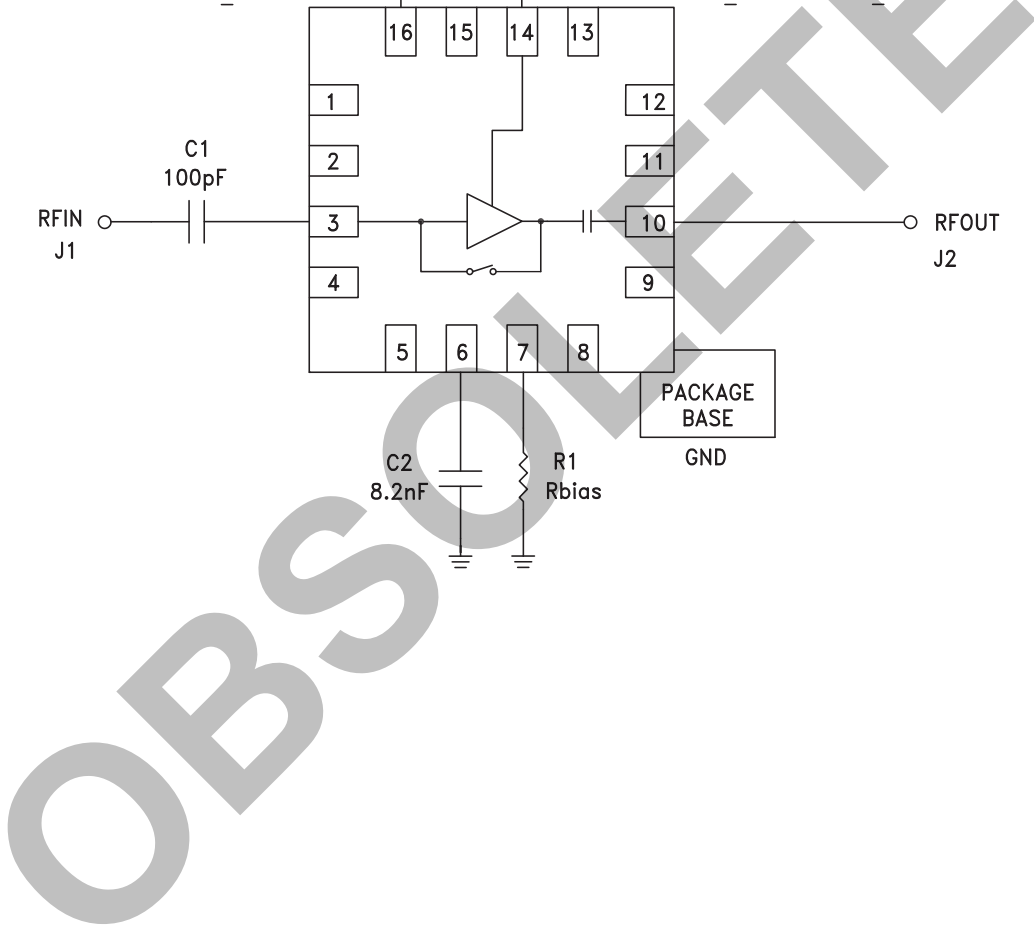



Evaluation PCB

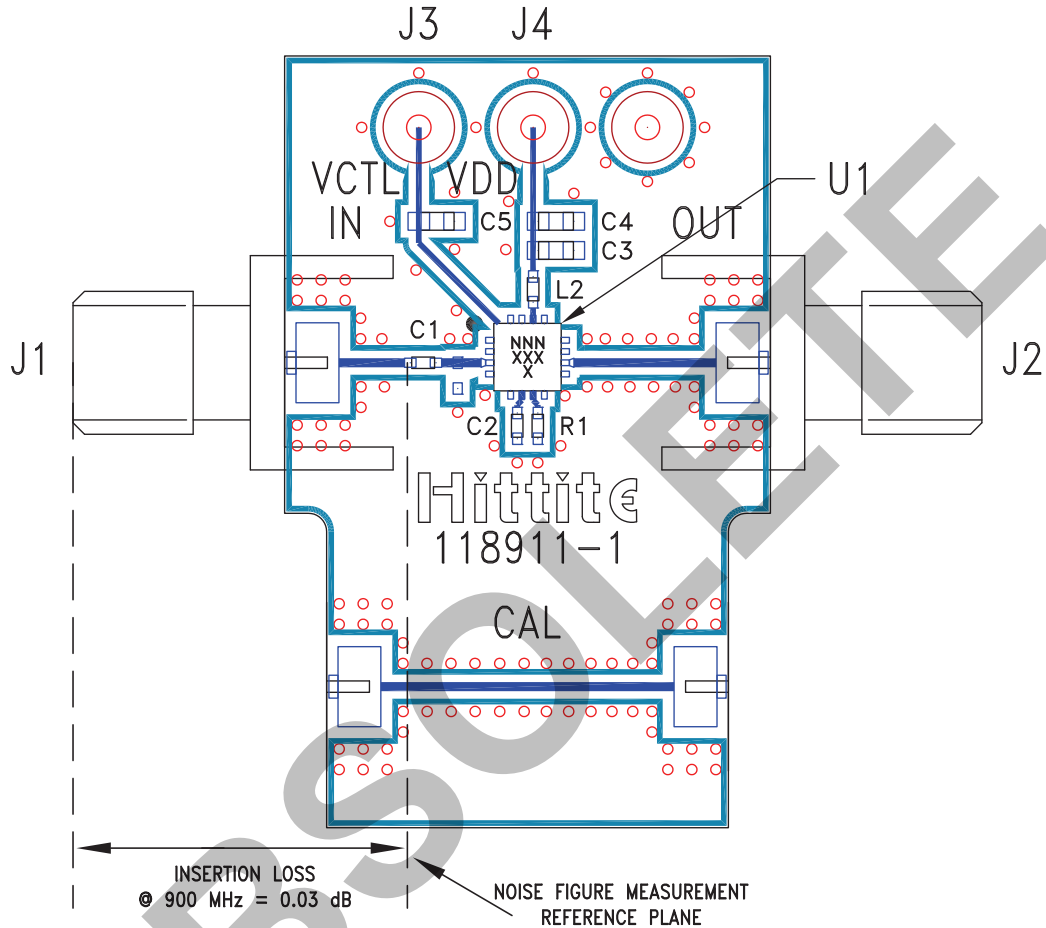

List of Materials for Evaluation PCB 121922 [1]

| Item | Description |
|---------|------------------------------|
| J1 - J2 | PCB Mount SMA Connector |
| J3 - J4 | DC Pin |
| C1 | 100 pF Capacitor, 0402 Pkg. |
| C2 | 8200 pF Capacitor, 0402 Pkg. |
| C3 | 10 nF Capacitor, 0603 Pkg. |
| C4 | 1 μF Capacitor, 0603 Pkg. |
| C5 | 100 pF Capacitor, 0603 Pkg. |
| L2 | 15 nH Inductor, 0402 Pkg. |
| R1 | 0 Ohm Resistor, 0402 Pkg. |
| U1 | HMC668LP3(E) Amplifier |
| PCB [2] | 118911 Evaluation Board |

The circuit board used in the application should use RF circuit design techniques. Signal lines should have 50 Ohm impedance while the package ground leads and exposed paddle should be connected directly to the ground plane similar to that shown. A sufficient number of via holes should be used to connect the top and bottom ground planes. The evaluation circuit board shown is available from Hittite upon request.

[1] Reference this number when ordering complete evaluation PCB

[2] Circuit Board Material: Rogers 4350

X-ON Electronics

Largest Supplier of Electrical and Electronic Components

Click to view similar products for [RF Amplifier](#) category:

Click to view products by [Analog Devices](#) manufacturer:

Other Similar products are found below :

[A82-1](#) [BGA622H6820XTSA1](#) [BGA 728L7 E6327](#) [BGB719N7ESDE6327XTMA1](#) [HMC397-SX](#) [HMC405](#) [HMC561-SX](#) [HMC8120-SX](#)
[HMC8121-SX](#) [HMC-ALH382-SX](#) [HMC-ALH476-SX](#) [SE2433T-R](#) [SMA3101-TL-E](#) [SMA39](#) [A66-1](#) [A66-3](#) [A67-1](#) [A81-2](#) [LX5535LQ](#)
[LX5540LL](#) [MAAM02350](#) [HMC3653LP3BETR](#) [HMC549MS8GETR](#) [HMC-ALH435-SX](#) [SMA101](#) [SMA32](#) [SMA411](#) [SMA531](#)
[SST12LP19E-QX6E](#) [WPM0510A](#) [HMC5929LS6TR](#) [HMC5879LS7TR](#) [HMC1126](#) [HMC1087F10](#) [HMC1086](#) [HMC1016](#) [SMA1212](#)
[MAX2689EWS+T](#) [MAAMSS0041TR](#) [MAAM37000-A1G](#) [LTC6430AIUF-15#PBF](#) [SMA70-2](#) [SMA4011](#) [A231](#) [HMC-AUH232](#) [LX5511LQ](#)
[LX5511LQ-TR](#) [HMC7441-SX](#) [HMC-ALH310](#) [XD1001-BD-000V](#)