

BiCMOS MMIC MIXER W/ INTEGRATED LO AMPLIFIER, 1.7 - 2.2 GHz



Typical Applications

The HMC687LP4(E) is Ideal for:

- Cellular/3G & LTE/WiMAX/4G
- Basestations & Repeaters
- GSM, CDMA & OFDM
- Transmitters and Receivers

Features

- High Input IP3: +35 dBm
- 8 dB Conversion Loss @ 0 dBm LO
- Optimized for High Side LO Input
- Upconversion & Downconversion Applications
- Adjustable Supply Current
- 24 Lead 4x4mm SMT Package: 16mm²

Functional Diagram

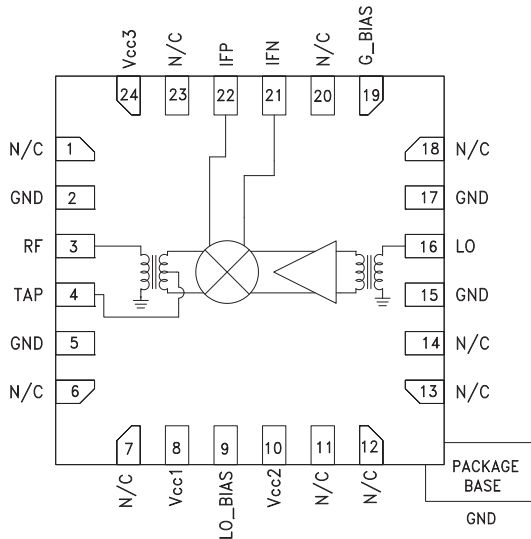

General Description

The HMC687LP4(E) is a high dynamic range passive MMIC mixer with integrated LO amplifier in a 4x4 SMT QFN package covering 1.7 to 2.2 GHz. Excellent input IP3 performance of +35 dBm for down conversion is provided for 3G & 4G GSM/CDMA applications at an LO drive of 0 dBm. With an input 1 dB compression of +23 dBm, the RF port will accept a wide range of input signal levels. Conversion loss is 8 dB typical. The DC to 500 MHz IF frequency response will satisfy GSM/CDMA transmit or receive frequency plans. The HMC687LP4(E) is optimized for high side LO frequency plans and is pin for pin compatible with the HMC685LP4(E) which is a 1.7 - 2.2 GHz converter optimized for low side LO.

Electrical Specifications,

$T_A = +25^\circ C$, $IF = 200 MHz$, $LO = 0 dBm$, $V_{cc} = V_{cc1, 2, 3} = +5V$, $G_Bias = +2.5V^*$

Nominal Supply	I _{cc} = 120 mA			I _{cc} = 100 mA	I _{cc} = 70 mA	Units
	Min.	Typ.	Max.	Typ.	Typ.	
Frequency Range, RF	1.7 - 2.2					GHz
Frequency Range, LO	1.7 - 2.4					GHz
Frequency Range, IF	DC - 500					MHz
Conversion Loss		8	10.5	8	8	dB
Noise Figure (SSB)		8		8	8	dB
LO to RF Isolation	22	30		32	34	dB
LO to IF Isolation	22	29		29	31	dB
RF to IF Isolation	31	42		42	42	dB
IP3 (Input)		35		34	32	dBm
1 dB Compression (Input)		23		22	20	dBm
LO Drive Input Level (Typical)	-3 to +3			-3 to +3	-3 to +3	dBm
Supply Current I _{cc} total		120	145	100	70	mA

* Unless otherwise noted all measurements performed as downconverter with high side LO & IF = 200 MHz.

Information furnished by Analog Devices is believed to be accurate and reliable. However, no responsibility is assumed by Analog Devices for its use, nor for any infringements of patents or other rights of third parties that may result from its use. Specifications subject to change without notice. No license is granted by implication or otherwise under any patent or patent rights of Analog Devices. Trademarks and registered trademarks are the property of their respective owners.

For price, delivery, and to place orders: Analog Devices, Inc., One Technology Way, P.O. Box 9106, Norwood, MA 02062-9106 Phone: 781-329-4700 • Order online at www.analog.com Application Support: Phone: 1-800-ANALOG-D

**BiCMOS MMIC MIXER W/ INTEGRATED
LO AMPLIFIER, 1.7 - 2.2 GHz**



Conversion Gain vs. Temperature

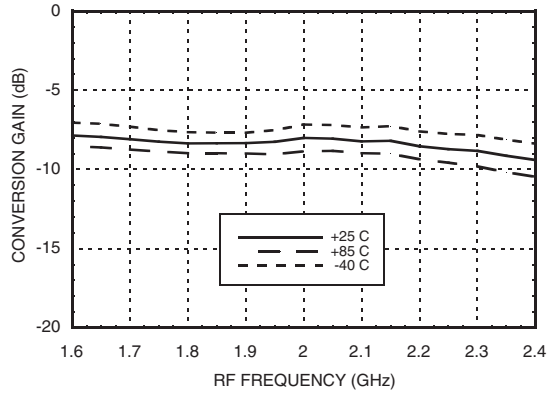

Isolation

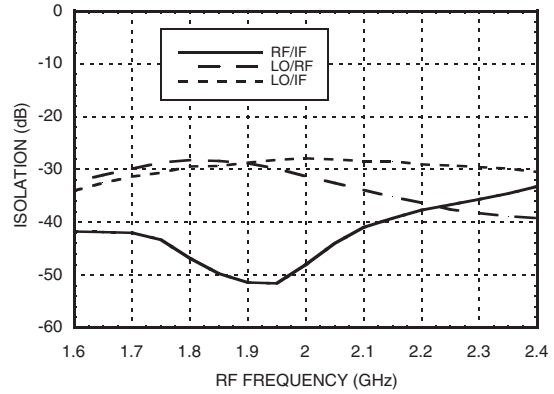

Conversion Gain vs. LO Drive

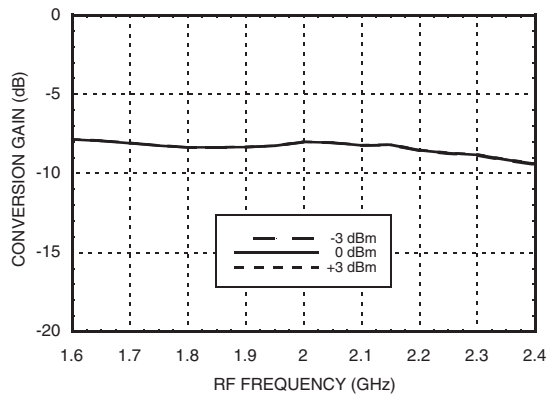

Return Loss

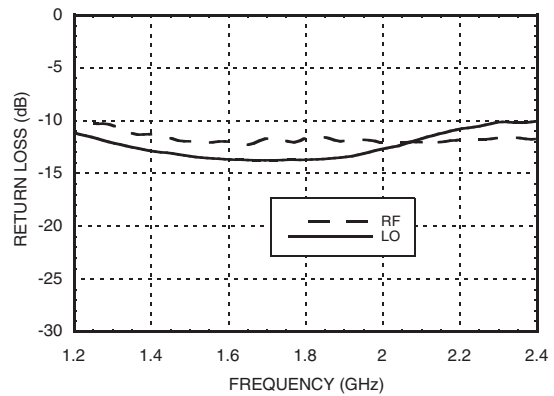

IF Bandwidth (LO= 2.2 GHz)

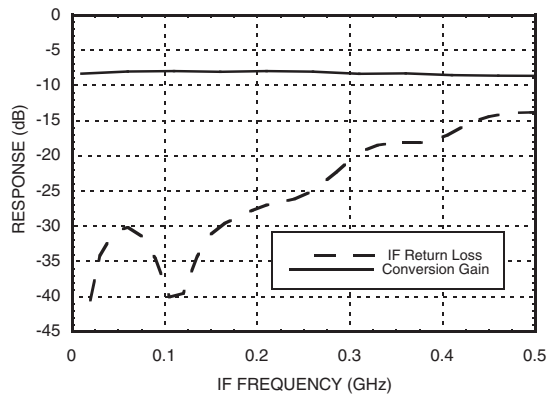

Input P1dB vs. Temperature

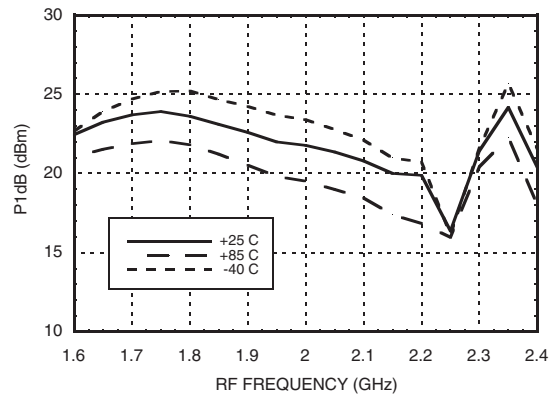

Information furnished by Analog Devices is believed to be accurate and reliable. However, no responsibility is assumed by Analog Devices for its use, nor for any infringements of patents or other rights of third parties that may result from its use. Specifications subject to change without notice. No license is granted by implication or otherwise under any patent or patent rights of Analog Devices. Trademarks and registered trademarks are the property of their respective owners.

For price, delivery, and to place orders: Analog Devices, Inc., One Technology Way, P.O. Box 9106, Norwood, MA 02062-9106 Phone: 781-329-4700 • Order online at www.analog.com Application Support: Phone: 1-800-ANALOG-D

BiCMOS MMIC MIXER W/ INTEGRATED LO AMPLIFIER, 1.7 - 2.2 GHz



Input IP3 vs. LO Drive [1]

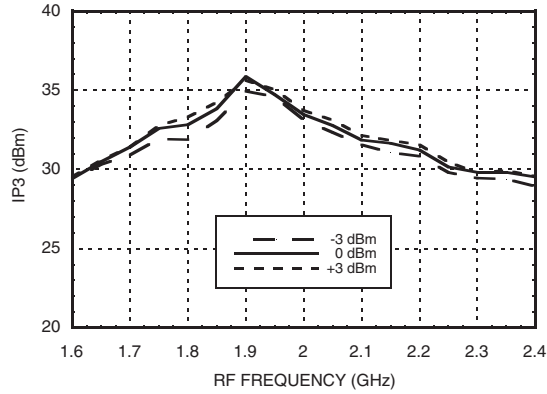

Input IP3 vs. Temperature [1]

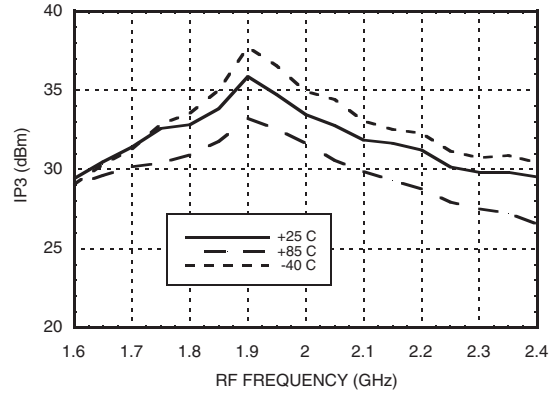

-2RF +2LO Response vs. Temperature [2]

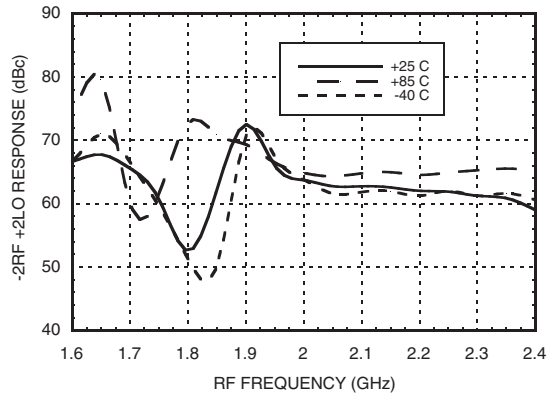

-2RF +2LO Response vs. LO Drive [2]

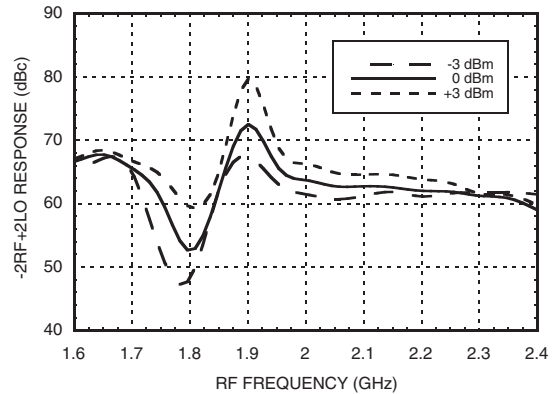

-3RF +3LO Response vs. Temperature [2]

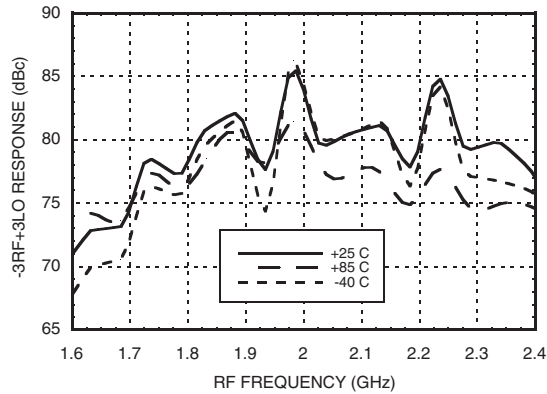

-3RF +3LO Response vs. LO Drive [2]

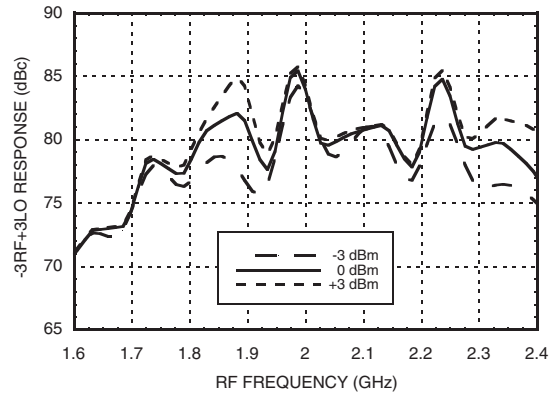

[1] Two-tone input power = +9 dBm each tone, 1 MHz spacing. [2] Referenced to RF Input power at 0 dBm

Information furnished by Analog Devices is believed to be accurate and reliable. However, no responsibility is assumed by Analog Devices for its use, nor for any infringements of patents or other rights of third parties that may result from its use. Specifications subject to change without notice. No license is granted by implication or otherwise under any patent or patent rights of Analog Devices. Trademarks and registered trademarks are the property of their respective owners.

For price, delivery, and to place orders: Analog Devices, Inc., One Technology Way, P.O. Box 9106, Norwood, MA 02062-9106 Phone: 781-329-4700 • Order online at www.analog.com Application Support: Phone: 1-800-ANALOG-D

BiCMOS MMIC MIXER W/ INTEGRATED LO AMPLIFIER, 1.7 - 2.2 GHz



Low Power Consumption Performance

Conversion Gain vs. G_Bias Voltage

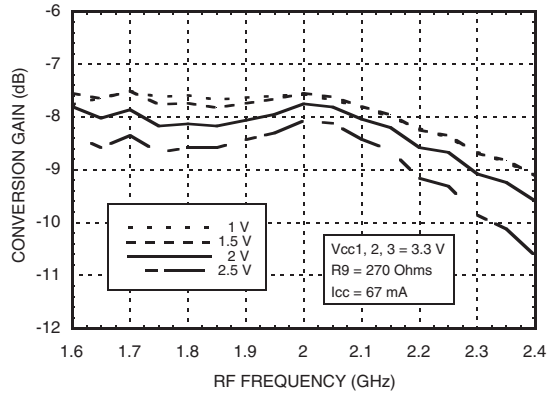

Input IP3 vs. G_Bias Voltage [1]

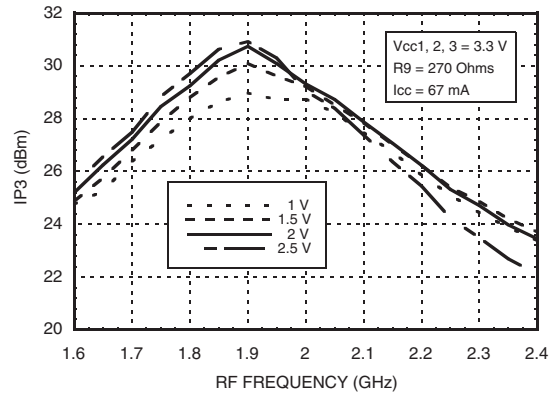

Conversion Gain vs. G_Bias Voltage

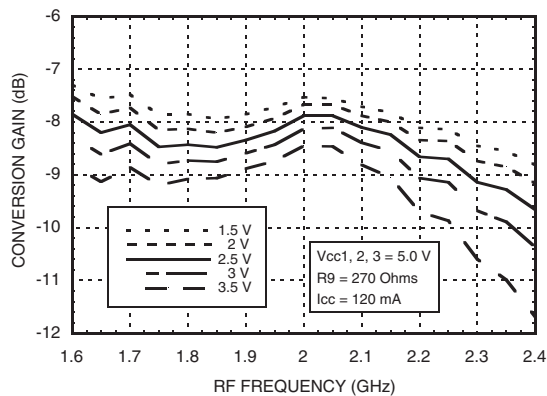

Input IP3 vs. G_Bias Voltage [1]

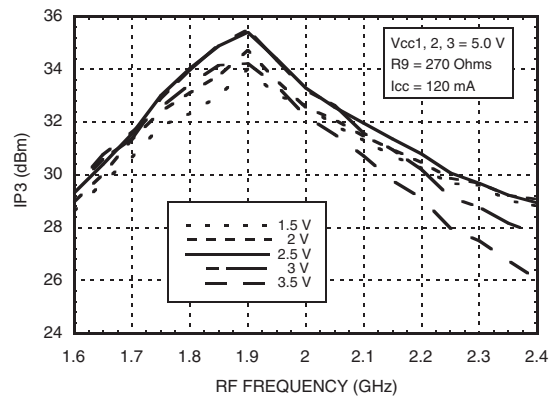

Conversion Gain vs. Icc

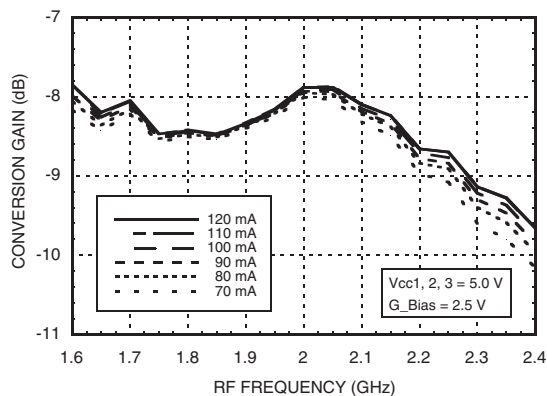

Input IP3 vs. Icc [1]

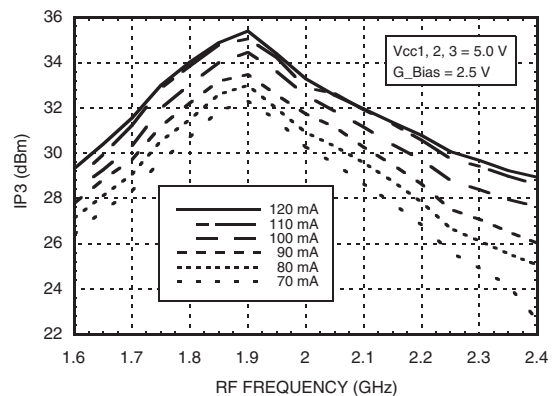

[1] Two-tone input power = +9 dBm each tone, 1 MHz spacing

BiCMOS MMIC MIXER W/ INTEGRATED LO AMPLIFIER, 1.7 - 2.2 GHz



Low Power Consumption Performance

Conversion Gain vs. Temperature, $I_{cc} = 70$ mA

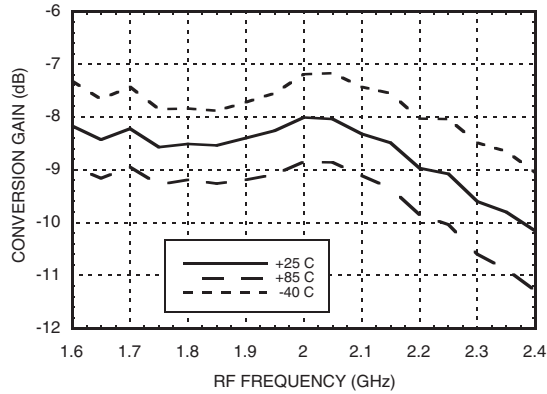

Input IP3 vs. Temperature, $I_{cc} = 70$ mA [1]

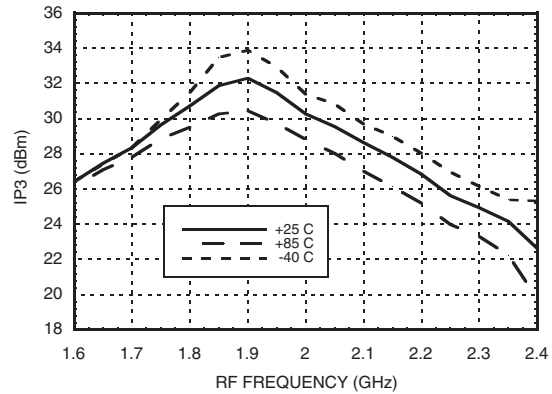

I_{cc} vs. R_9

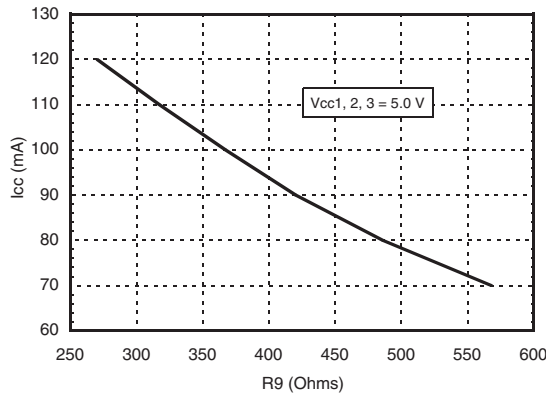

Typical Upconverter Performance

Conversion Gain vs. LO Drive

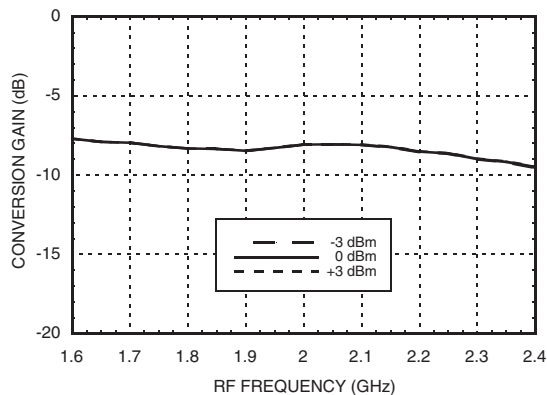

Input IP3 vs. LO Drive [1]

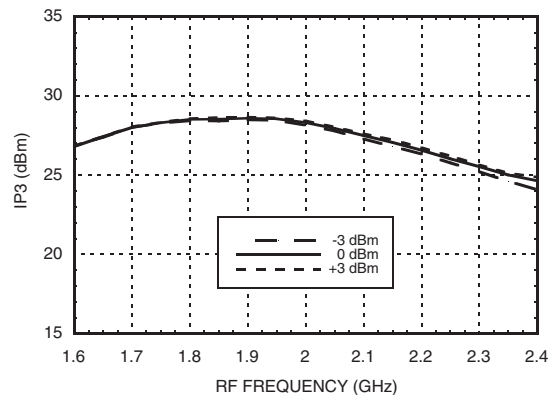

[1] Two-tone input power = +9 dBm each tone, 1 MHz spacing.

**BiCMOS MMIC MIXER W/ INTEGRATED
LO AMPLIFIER, 1.7 - 2.2 GHz**

Absolute Maximum Ratings

RF / IF Input (Vcc1, 2, 3 = +5V)	+23 dBm
LO Drive (Vcc1, 2, 3 = +5V)	+10 dBm
Vcc1,2,3	+5.5V
Channel Temperature	125 °C
Continuous Pdiss (T = 85°C) (derate 20.69 mW/°C above 85°C)	0.83 mW
Thermal Resistance (channel to ground paddle)	48.33 °C/W
Storage Temperature	-65 to 150 °C
Operating Temperature	-40 to +85 °C



**ELECTROSTATIC SENSITIVE DEVICE
OBSERVE HANDLING PRECAUTIONS**

Typical Supply Current vs. Vcc

Vcc1, 2, 3 (V)	Icc total (mA)
4.75	113
5.00	120
5.25	127

Downconverter will operate over full voltage range shown above.

MxN Spurious @ IF Port

mRF	nLO				
	0	1	2	3	4
0	xx	20	27	54	28
1	43	0	39	31	57
2	64	60	59	68	87
3	110	81	102	77	96
4	115	129	115	115	112

RF Freq. = 1.9 GHz @ 0 dBm
LO Freq. = 2.1 GHz @ 0 dBm
All values in dBc below IF power level (-1RF + 1LO).

Harmonics of LO

LO Freq. (GHz)	nLO Spur @ RF Port			
	1	2	3	4
1.6	37	25	46	42
1.7	35	24	44	41
1.8	33	23	43	42
1.9	30	22	36	36
2.0	29	23	40	28
2.1	29	24	44	27
2.2	32	24	42	31
2.3	34	24	42	38

LO = 0 dBm
All values in dBc below input LO level measured at RF port.

[1] Two-tone input power = +9 dBm each tone, 1 MHz spacing.

BICMOS MMIC MIXER W/ INTEGRATED LO AMPLIFIER, 1.7 - 2.2 GHz



Outline Drawing

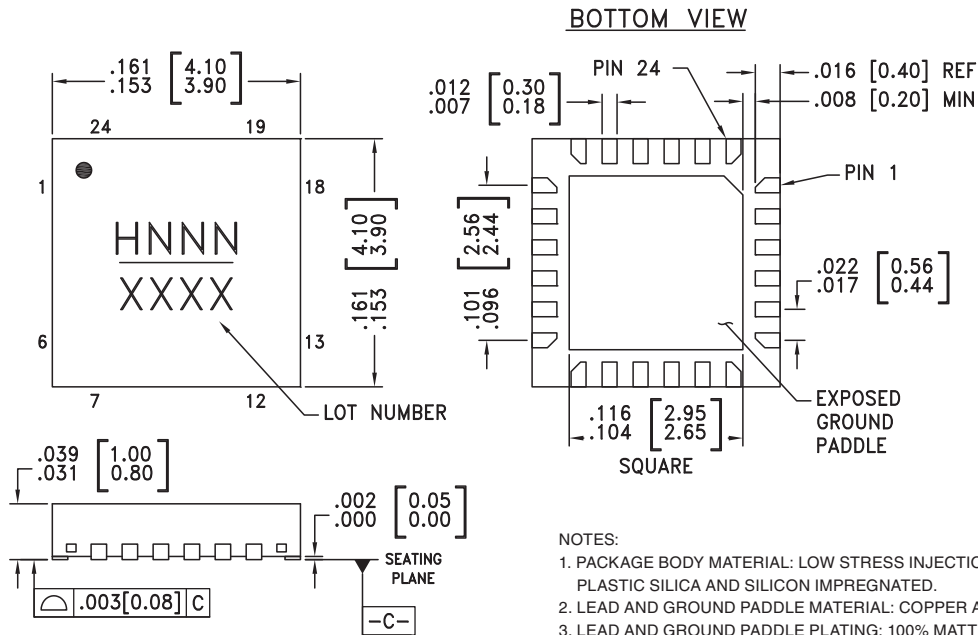

NOTES:

1. PACKAGE BODY MATERIAL: LOW STRESS INJECTION MOLDED PLASTIC SILICA AND SILICON IMPREGNATED.
2. LEAD AND GROUND PADDLE MATERIAL: COPPER ALLOY.
3. LEAD AND GROUND PADDLE PLATING: 100% MATTE TIN.
4. DIMENSIONS ARE IN INCHES [MILLIMETERS].
5. LEAD SPACING TOLERANCE IS NON-CUMULATIVE.
6. PAD BURR LENGTH SHALL BE 0.15mm MAX.
PAD BURR HEIGHT SHALL BE 0.25mm MAX.
7. PACKAGE WARP SHALL NOT EXCEED 0.05mm
8. ALL GROUND LEADS AND GROUND PADDLE MUST BE SOLDERED TO PCB RF GROUND.
9. REFER TO HITTITE APPLICATION NOTE FOR SUGGESTED PCB LAND PATTERN.

Package Information

Part Number	Package Body Material	Lead Finish	MSL Rating	Package Marking ^[3]
HMC687LP4	Low Stress Injection Molded Plastic	Sn/Pb Solder	MSL1 ^[1]	H687 XXXX
HMC687LP4E	RoHS-compliant Low Stress Injection Molded Plastic	100% matte Sn	MSL1 ^[2]	H68Z XXXX

[1] Max peak reflow temperature of 235 °C
 [2] Max peak reflow temperature of 260 °C
 [3] 4-Digit lot number XXXX

BiCMOS MMIC MIXER W/ INTEGRATED LO AMPLIFIER, 1.7 - 2.2 GHz



Pin Descriptions

Pin Number	Function	Description	Interface Schematic
1, 6, 7, 11 - 14, 18, 20, 23	N/C	No connection. These pins may be connected to RF ground. Performance will not be affected.	
2, 5, 15, 17	GND	Package bottom must be connected to RF/DC ground.	
3	RF	This pin is matched single-ended 50 Ohm and DC shorted to ground through a balun.	
4	TAP	Center tap of secondary side of the internal RF balun. Short to ground with a zero ohm close to the IC.	
8, 10, 24	Vcc1, Vcc2, Vcc3	Power supply voltage. See application circuit for required external components.	
9	LO_BIAS	LO buffer current adjustment pin. Adjust the LO buffer current through the external resistor R9 shown in the application circuit (connect 270 Ohms for nominal operation). This adjustment allows for a trade-off between power dissipation and linearity performance of the converter.	
16	LO	This pin is matched single-ended 50 Ohm and DC shorted to ground through a balun.	
19	G_BIAS	External bias. See application circuit for recommended external components. Apply +2.5V for nominal operation at 5V supply voltage. G_Bias can be set to between 0 and 5Vdc. The G_bias pin has an internal 15K ohm resistance to ground. This adjustment allows for a trade off between conversion loss and linearity performance of the converter (see figures CG, IP3 vs. G-Bias).	
21, 22	IFN, IFP	Differential IF input / output pins matched to differential 50 Ohms. For applications not requiring operation to DC an off chip DC blocking capacitor should be used.	

Information furnished by Analog Devices is believed to be accurate and reliable. However, no responsibility is assumed by Analog Devices for its use, nor for any infringements of patents or other rights of third parties that may result from its use. Specifications subject to change without notice. No license is granted by implication or otherwise under any patent or patent rights of Analog Devices. Trademarks and registered trademarks are the property of their respective owners.

For price, delivery, and to place orders: Analog Devices, Inc., One Technology Way, P.O. Box 9106, Norwood, MA 02062-9106 Phone: 781-329-4700 • Order online at www.analog.com Application Support: Phone: 1-800-ANALOG-D

**BiCMOS MMIC MIXER W/ INTEGRATED
LO AMPLIFIER, 1.7 - 2.2 GHz**



Evaluation PCB

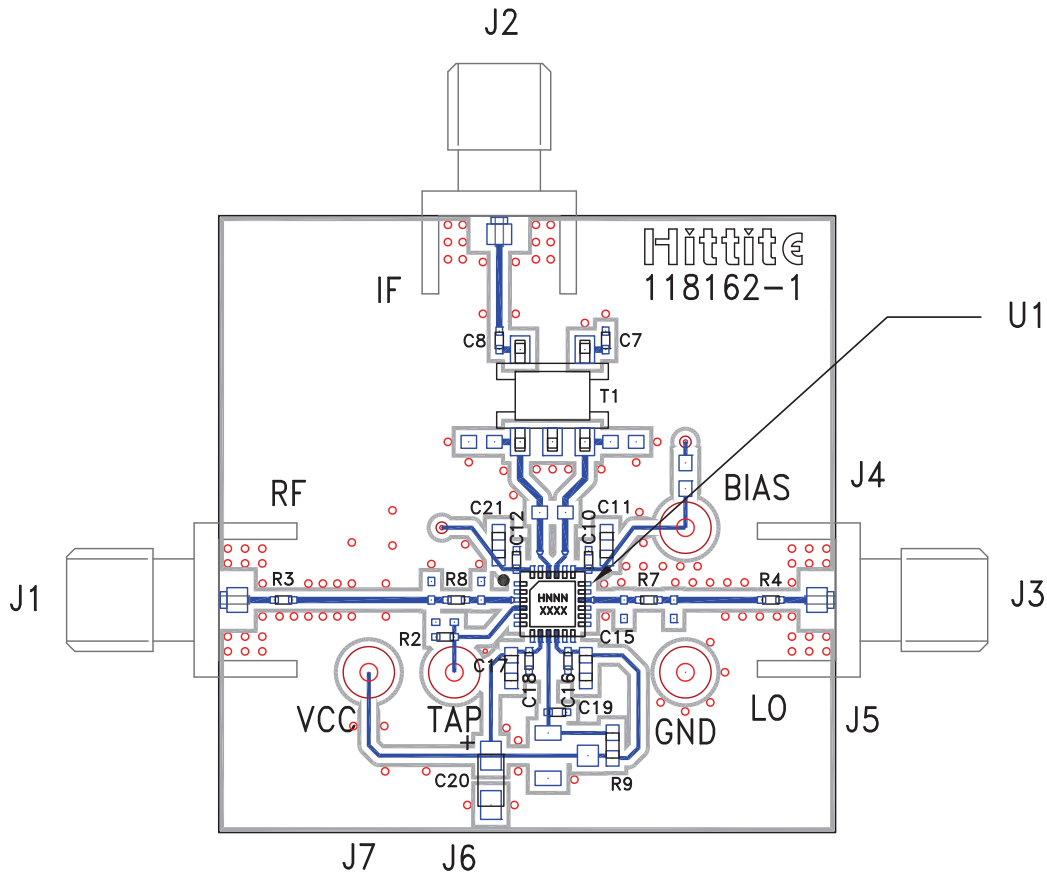

List of Materials for Evaluation PCB 119935 [1]

Item	Description
J1 - J3	SMA Connector
J4 - J7	DC Pin
C19	22 pF Capacitor, 0402 Pkg.
C7, C8	10 nF Capacitor, 0402 Pkg.
C10, C12, C16, C18	1 nF Capacitor, 0402 Pkg.
C11, C15, C17, C21	0.1 μF Capacitor, 0402 Pkg.
C20	4.7 μF Case A, Tantalum
R2 - R4, R7, R8	0 Ohm Resistor, 0402 Pkg.
R9	270 Ohm Resistor, 0603 Pkg.
T1	1:1 Transformer - Tyco MABA CT0039
U1	HMC687LP4(E) Downconverter
PCB [2]	118162 Evaluation PCB

The circuit board used in the application should use RF circuit design techniques. Signal lines should have 50 Ohm impedance while the package ground leads and exposed paddle should be connected directly to the ground plane similar to that shown. A sufficient number of via holes should be used to connect the top and bottom ground planes. The evaluation circuit board shown is available from Hitite upon request.

[1] Reference this number when ordering complete evaluation PCB

[2] Circuit Board Material: Arlon 25R, FR4

BiCMOS MMIC MIXER W/ INTEGRATED LO AMPLIFIER, 1.7 - 2.2 GHz



Application Circuit

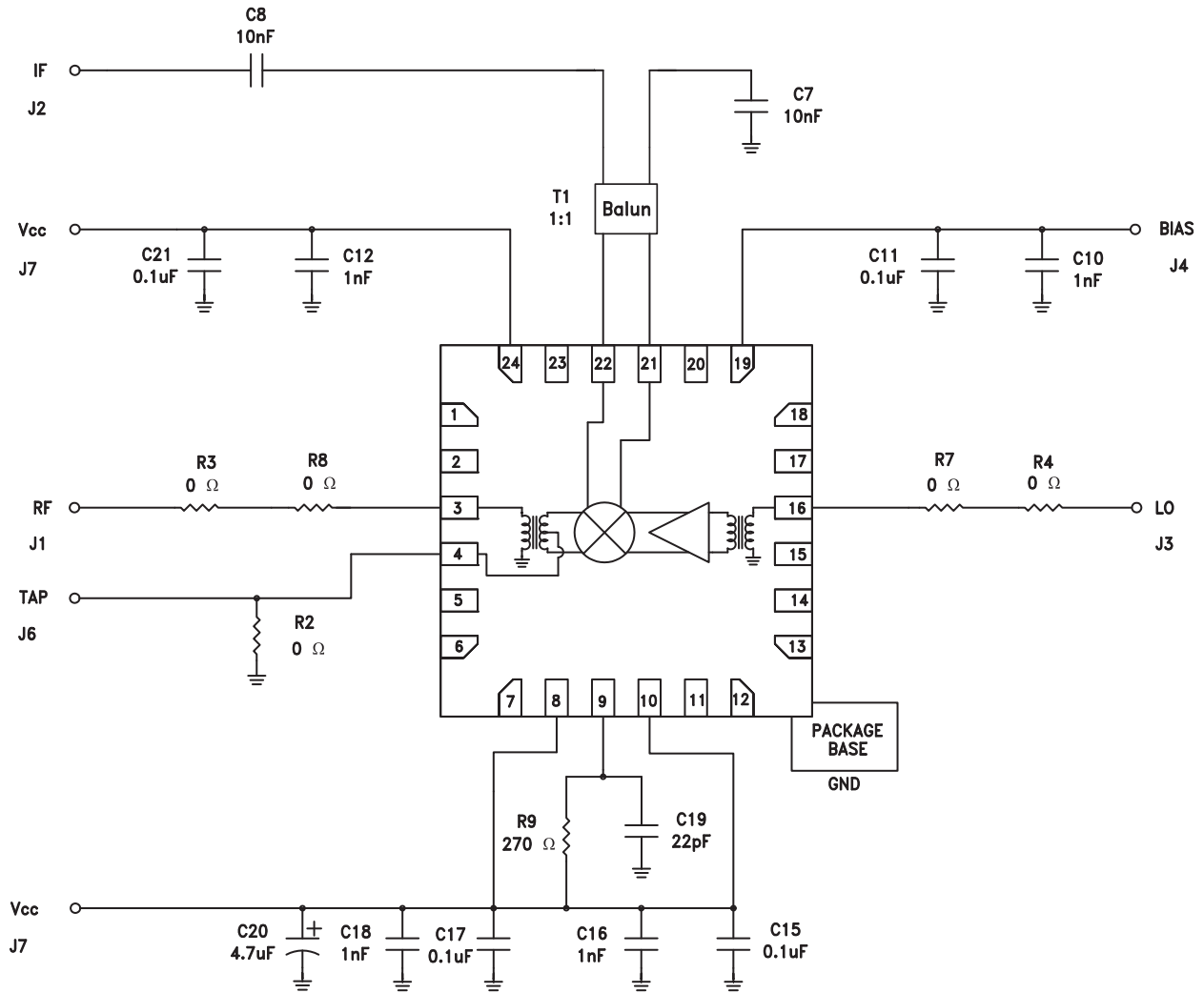

Information furnished by Analog Devices is believed to be accurate and reliable. However, no responsibility is assumed by Analog Devices for its use, nor for any infringements of patents or other rights of third parties that may result from its use. Specifications subject to change without notice. No license is granted by implication or otherwise under any patent or patent rights of Analog Devices. Trademarks and registered trademarks are the property of their respective owners.

For price, delivery, and to place orders: Analog Devices, Inc., One Technology Way, P.O. Box 9106, Norwood, MA 02062-9106 Phone: 781-329-4700 • Order online at www.analog.com Application Support: Phone: 1-800-ANALOG-D

X-ON Electronics

Largest Supplier of Electrical and Electronic Components

Click to view similar products for [RF Mixer](#) category:

Click to view products by [Analog Devices](#) manufacturer:

Other Similar products are found below :

[HMC337-SX](#) [HMC404-SX](#) [mamx-009646-23dbml](#) [HMC339-SX](#) [HMC8192-SX](#) [MIQ24MS-2](#) [HMC220BMS8GETR](#) [M85C](#) [HMC554A-SX](#)
[HMC8192LG](#) [HMC521A-SX](#) [HMC521ACHIPS](#) [CMD258C4](#) [LT5511EFE](#) [MAMX-011023-SMB](#) [HMC399MS8TR](#) [HMC333TR](#)
[HMC214MS8TR](#) [HMC175MS8TR](#) [MAMXSS0012TR-3000](#) [109728-HMC129LC4](#) [CSM1-13](#) [SA612AD/01.112](#) [HMC785LP4ETR](#)
[LT5526EUF#PBF](#) [LT5579IUH#PBF](#) [HMC773ALC3BTR](#) [HMC558ALC3B](#) [HMC329ALC3B](#) [MY63H](#) [AD8343ARUZ-REEL7](#) [AD608AR](#)
[AD608ARZ](#) [AD831APZ](#) [AD831APZ-REEL7](#) [AD8342ACPZ-REEL7](#) [AD8343ARUZ](#) [AD8344ACPZ-REEL7](#) [ADL5350ACPZ-R7](#)
[ADL5363ACPZ-R7](#) [ADL5365ACPZ-R7](#) [ADL5801ACPZ-R7](#) [ADL5802ACPZ-R7](#) [HMC1056LP4BE](#) [HMC1057-SX](#) [HMC1063LP3E](#)
[HMC1093-SX](#) [HMC1106-SX](#) [HMC129](#) [HMC143](#)