



## 7 GHz INTEGER N SYNTHESIZER CONTINUOUS (N = 56 - 519), NON-CONTINUOUS (N = 16 - 54)

### Typical Applications

The HMC699LP5(E) is ideal for:

- Satellite Communication Systems
- Point-to-Point Radios
- Military Applications
- Sonet Clock Generation

### Features

- Ultra Low SSB Phase Noise Floor:  
-153 dBc/Hz @ 10 kHz offset @ 100 MHz Reference Frequency.
- Programmable Divider (N = 16 - 519)  
Operating up to 7 GHz
- Open Collector Output Buffer Amplifiers for Interfacing w/ Op-Amp Based Loop Filter
- Reversible Polarity PFD w/ Lock Detect Output
- 32 Lead 5x5mm SMT Package: 25mm<sup>2</sup>

### Functional Diagram

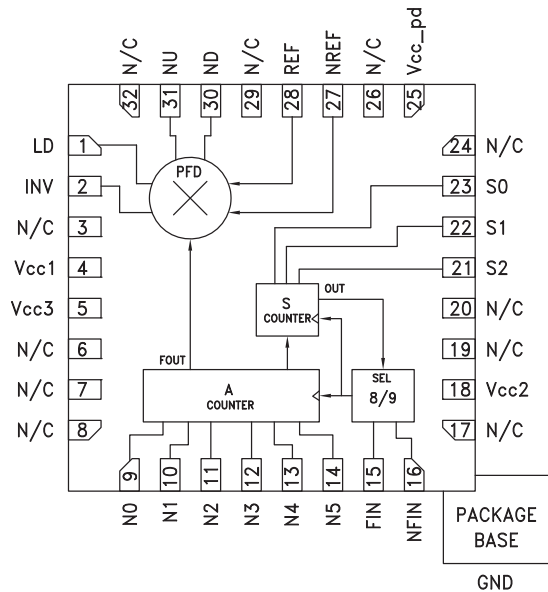

### General Description

The HMC699LP5(E) is a frequency synthesizer with a wideband reversible polarity digital PFD and lock detect output. The divider operates from 160 - 7000 MHz with a continuous integer division ratio N = 56 to 519 and non-continuous division ratio N = 16 to 54. The HMC699LP5(E) high frequency operation along with ultra low phase noise floor make possible synthesizers with wide loop bandwidth and low N resulting in fast settling and very low phase noise. When used in conjunction with a differential loop filter, the HMC699LP5(E) can be used to phase lock a VCO to a reference oscillator. For continuous division ratio, the A counter and S counter must satisfy the condition:  $A + 1 \geq S$ .

### Electrical Specifications, $T_A = +25^\circ\text{C}$ , $V_{cc} = V_{cc1} = V_{cc2} = V_{cc3} = V_{cc\_pd} = 5\text{V}$

| Parameter                    | Conditions  | Min. | Typ. | Max. | Units       |
|------------------------------|---|------|------|------|-------------|
| Maximum Ref. Input Frequency | Sine or Square Wave Input [1]                                   | 1300 |      |      | MHz         |
| Minimum Ref. Input Frequency | Square Wave Input [2]   |      |      | 10   | MHz         |
| Reference Input Power Range  | 100 MHz Frequency   | -5   |      | +5   | dBm         |
| Maximum VCO Input Frequency  |   | 7000 |      |      | MHz         |
| Minimum VCO Input Frequency  | Sine Wave Input   |      |      | 160  | MHz         |
| VCO Input Power Range        | 100 MHz Input Frequency   | -10  |      | +5   | dBm         |
| PFD Output Voltage           |   |      | 2000 |      | mV, Pk - Pk |
| PFD Gain                     | Gain = $V_{pp} / 2\pi$ Rad.                                     |      | 0.32 |      | V/Rad.      |
| SSB Phase Noise              | @ 10 kHz Offset @ 100 MHz Square Wave Ref. Input<br>Pin = 0 dBm |      | -153 |      | dBc/Hz      |
| Total Supply Current         |   |      | 345  |      | mA          |

[1] Maximum frequencies may be limited by available counter division ratio.

[2] Square wave input achieves best phase noise at lower reference frequency (see sine & square wave comparison plots)



**7 GHz INTEGER N SYNTHESIZER  
CONTINUOUS (N = 56 - 519), NON-CONTINUOUS (N = 16 - 54)**

**Phase Noise Floor [1][2][3]**

**Ref = Sine Wave, Vcc = 4.75V**

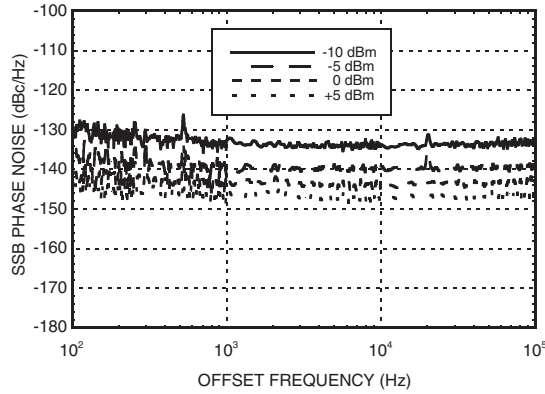

**Phase Noise Floor [1][2][3]**

**Ref = Square Wave, Vcc = 4.75V**

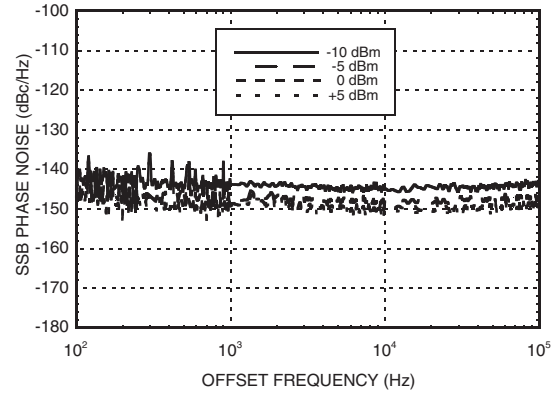

**Phase Noise Floor [1][2][3]**

**Ref = Sine Wave, Vcc = 5V**

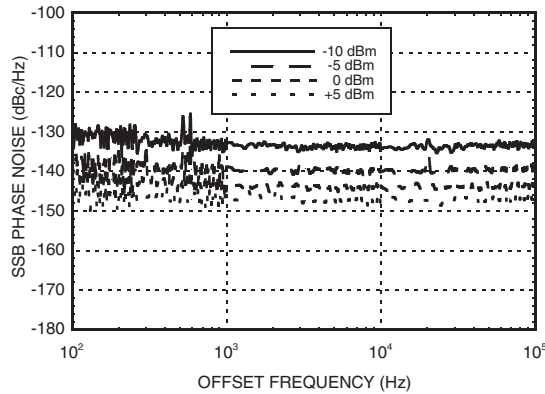

**Phase Noise Floor [1][2][3]**

**Ref = Square Wave, Vcc = 5V**

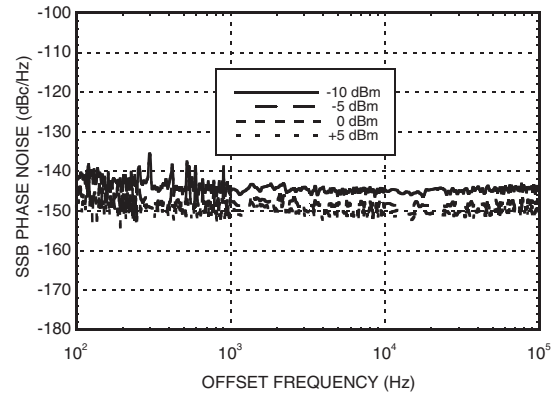

**Phase Noise Floor [1][2][3]**

**Ref = Sine Wave, Vcc = 5.25V**

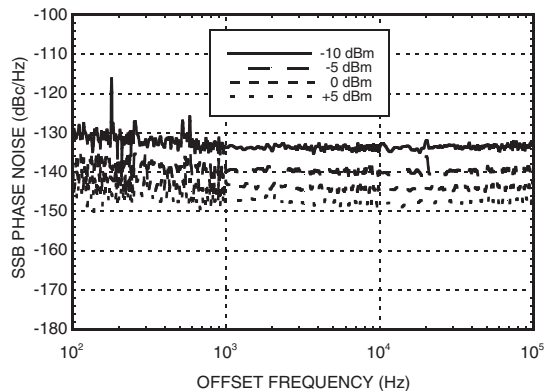

**Phase Noise Floor [1][2][3]**

**Ref = Square Wave, Vcc = 5.25V**

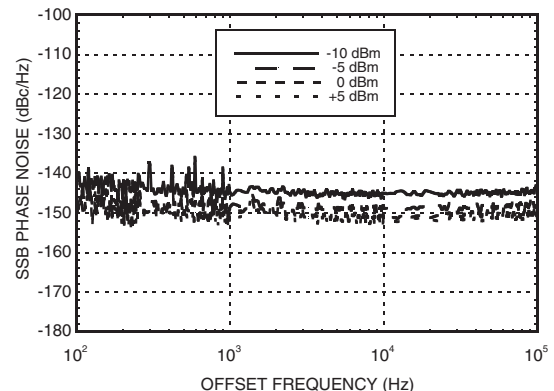

- [1] Phase Noise Floor vs Offset Frequency with varying Ref Power Level
- [2] Fin = 7000 MHz @ 0 dBm, Ref Frequency = 100 MHz, N = 70
- [3] Phase Noise Floor remains constant beyond 100 kHz offset frequency

Information furnished by Analog Devices is believed to be accurate and reliable. However, no responsibility is assumed by Analog Devices for its use, nor for any infringements of patents or other rights of third parties that may result from its use. Specifications subject to change without notice. No license is granted by implication or otherwise under any patent or patent rights of Analog Devices. Trademarks and registered trademarks are the property of their respective owners.

For price, delivery, and to place orders: Analog Devices, Inc., One Technology Way, P.O. Box 9106, Norwood, MA 02062-9106 Phone: 781-329-4700 • Order online at [www.analog.com](http://www.analog.com) Application Support: Phone: 1-800-ANALOG-D



## 7 GHz INTEGER N SYNTHESIZER CONTINUOUS (N = 56 - 519), NON-CONTINUOUS (N = 16 - 54)

### Phase Noise Floor [1][2][3]

Ref = Square Wave @ 5 dBm, Vcc = 5V

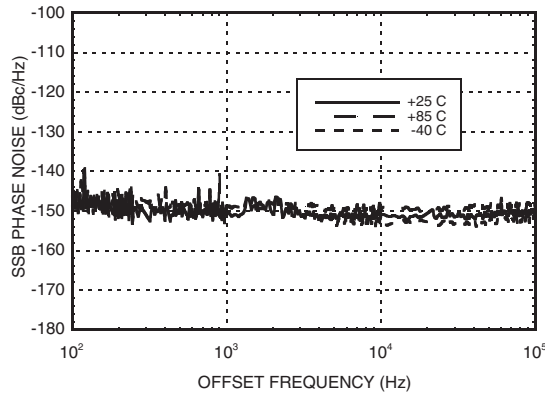

### Phase Noise Floor [1][2][3]

Ref = Sine Wave @ 5 dBm, Vcc = 5V

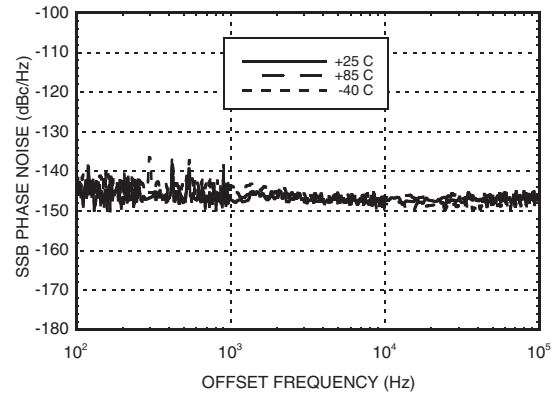

### Phase Noise Floor vs Offset Frequency with varying Fin @ 0 dBm, Ref = 100 MHz Square Wave @ 5 dBm, Vcc = 5V [3]

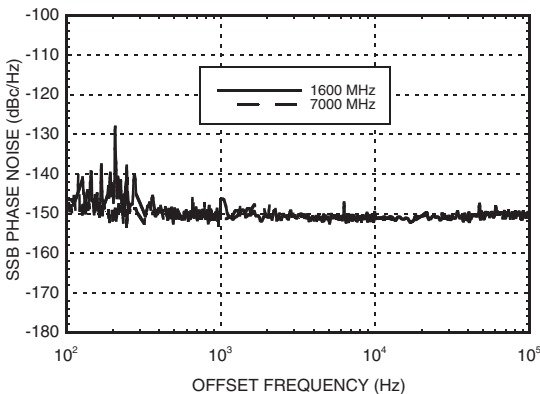

### Absolute Maximum Ratings

|   |                       |
|---|-----------------------|
| RF Input (Vcc = +5V)  | +10 dBm               |
| Supply Voltage (Vcc)  | +5.5V                 |
| Logic Inputs  | -0.5V to (0.5V + Vcc) |
| Junction Temperature (Tc)   | 135 °C                |
| Continuous P <sub>diss</sub> (T = 85 °C)<br>(derate 87 mW/°C above 85 °C) | 4.3 W                 |
| Thermal Resistance<br>(Junction to ground paddle)                         | 11.60 °C/W            |
| Storage Temperature   | -65 to +150 °C        |
| Operating Temperature   | -40 to +85 °C         |

### Typical DC Characteristics @ Vcc = +5V

| Symbol          | Characteristics               | +25°C |      |      | Units |
|-----------------|-------------------------------|-------|------|------|-------|
|                 |                               | Min.  | Typ. | Max. |       |
| I <sub>cc</sub> | Power Supply Current          | 310   | 345  | 380  | mA    |
| V <sub>oh</sub> | Output High Voltage, (NU, ND) | 5     | 5    | 5    | V     |
| V <sub>ol</sub> | Output Low Voltage, (NU, ND)  | 2.9   | 3.0  | 3.1  | V     |

### Typical Supply Current vs. Vcc

| Vcc (V) | I <sub>cc</sub> (mA) |
|---------|----------------------|
| 4.75    | 318                  |
| 5.00    | 345                  |
| 5.25    | 369                  |

Note: HMC669LP5(E) will work over full voltage range above.



ELECTROSTATIC SENSITIVE DEVICE  
OBSERVE HANDLING PRECAUTIONS

[1] Phase Noise Floor vs Offset Frequency over temperature

[2] Fin= 7000 MHz @ 0 dBm, Ref Frequency = 100 MHz, N = 70

[3] Phase Noise Floor remains constant beyond 100 kHz offset frequency



## 7 GHz INTEGER N SYNTHESIZER CONTINUOUS (N = 56 - 519), NON-CONTINUOUS (N = 16 - 54)

### Outline Drawing

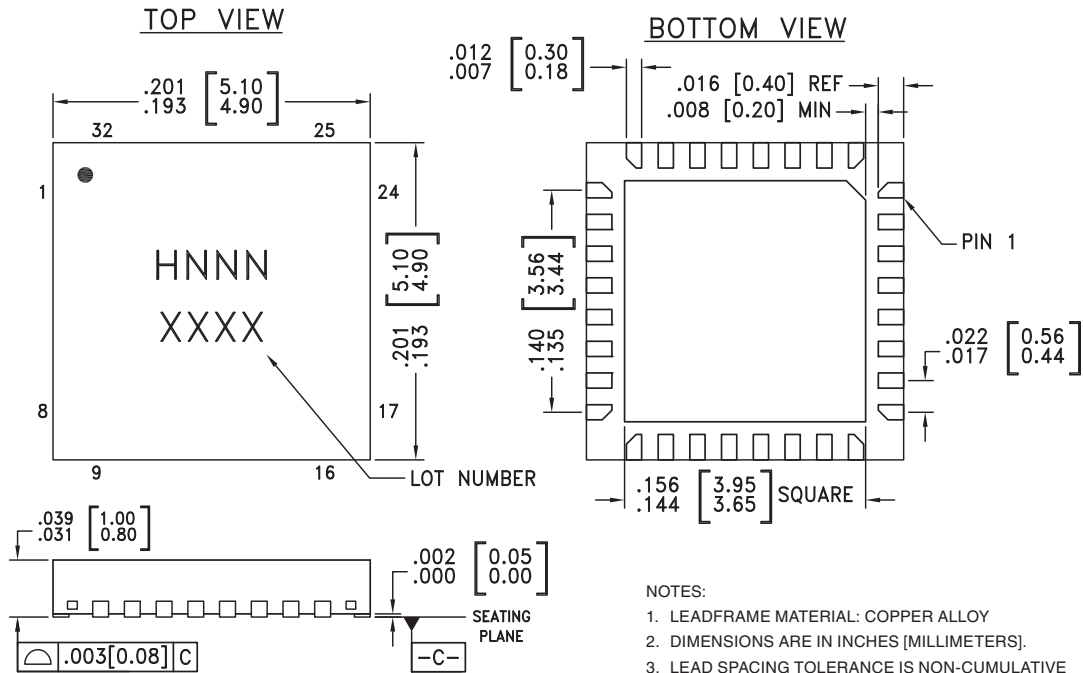

**NOTES:**

- LEADFRAME MATERIAL: COPPER ALLOY
- DIMENSIONS ARE IN INCHES [MILLIMETERS].
- LEAD SPACING TOLERANCE IS NON-CUMULATIVE
- PAD BURR LENGTH SHALL BE 0.15mm MAXIMUM.  
PAD BURR HEIGHT SHALL BE 0.05mm MAXIMUM.
- PACKAGE WARP SHALL NOT EXCEED 0.05mm.
- ALL GROUND LEADS AND GROUND PADDLE MUST BE SOLDERED TO PCB RF GROUND.
- REFER TO HITTITE APPLICATION NOTE FOR SUGGESTED PCB LAND PATTERN.

### Package Information

| Part Number  | Package Body Material                              | Lead Finish   | MSL Rating          | Package Marking <sup>[3]</sup> |
|--------------|--|---------------|---------------------|--------------------------------|
| HMC699LP5    | Low Stress Injection Molded Plastic                | Sn/Pb Solder  | MSL1 <sup>[1]</sup> | H699<br>XXXX                   |
| HMC699LP5(E) | RoHS-compliant Low Stress Injection Molded Plastic | 100% matte Sn | MSL1 <sup>[2]</sup> | H699<br>XXXX                   |

[1] Max peak reflow temperature of 235 °C  
 [2] Max peak reflow temperature of 260 °C  
 [3] 4-Digit lot number XXXX



## 7 GHz INTEGER N SYNTHESIZER CONTINUOUS (N = 56 - 519), NON-CONTINUOUS (N = 16 - 54)

### Pin Description

| Pin Number                           | Function                 | Description  | Interface Schematic |
|--------------------------------------|--------------------------|--|---------------------|
| 1                                    | LD                       | Pulsed output.<br>Average "LOW" = UNLOCKED.<br>Average "HIGH" = LOCKED   |                     |
| 2                                    | INV                      | PFD INVERT function<br>CMOS compatible input control bit<br>Logic "LOW" = NORMAL<br>Logic "HIGH" = INVERT                                |                     |
| 3, 6 - 8, 17, 19, 20, 24, 26, 29, 32 | N/C                      | The pins are not connected internally; however, all data shown herein was measured with these pins connected to RF/DC ground externally. |                     |
| 4, 5, 18, 25                         | Vcc1, Vcc3, Vcc2, Vcc_pd | Supply Voltage 5V ±0.25V   |                     |
| 9 - 14                               | N0 - N5                  | CMOS compatible control input bit 0 (LSB) - 5  |                     |
| 15                                   | FIN                      | (These pins are AC coupled and must be DC Blocked externally.)<br>Frequency Input  |                     |
| 16                                   | NFIN                     | Frequency Input Complement   |                     |
| 22, 23                               | S1, S0                   | CMOS compatible<br>Control Input<br>bit 0 (LSB) -1   |                     |

Information furnished by Analog Devices is believed to be accurate and reliable. However, no responsibility is assumed by Analog Devices for its use, nor for any infringements of patents or other rights of third parties that may result from its use. Specifications subject to change without notice. No license is granted by implication or otherwise under any patent or patent rights of Analog Devices. Trademarks and registered trademarks are the property of their respective owners.

For price, delivery, and to place orders: Analog Devices, Inc., One Technology Way, P.O. Box 9106, Norwood, MA 02062-9106  
Phone: 781-329-4700 • Order online at [www.analog.com](http://www.analog.com)  
Application Support: Phone: 1-800-ANALOG-D

**7 GHz INTEGER N SYNTHESIZER  
CONTINUOUS (N = 56 - 519), NON-CONTINUOUS (N = 16 - 54)**
**Pin Description (Continued)**

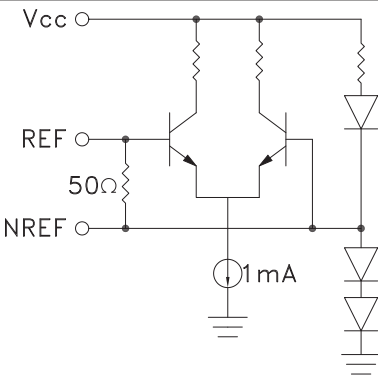
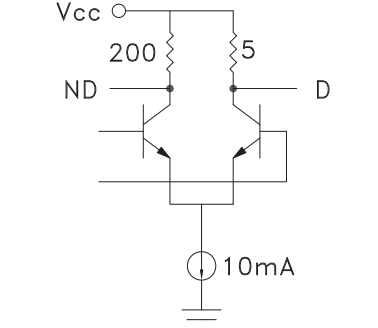
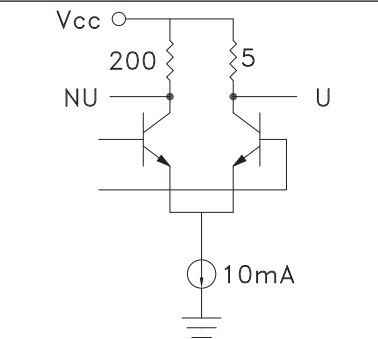
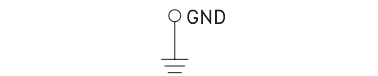
| Pin Number    | Function | Description  | Interface Schematic   |
|---------------|----------|--|---|
| 28            | REF      | Reference Input  |    |
| 27            | NREF     | Reference Input Complement<br><br>(These pins are AC coupled and must be DC Blocked externally.) |   |
| 30            | ND       | Down Output  |   |
| 31            | NU       | Up Output  |  |
| Ground Paddle | GND      | Package bottom has an exposed ground paddle that must be connected to RF/DC ground               |  |

**7 GHz INTEGER N SYNTHESIZER  
CONTINUOUS (N = 56 - 519), NON-CONTINUOUS (N = 16 - 54)**
**HMC699LP5(E) Programming**

The decimal value of A counter and S counter can be defined as:

$$A = \text{int} \left( \frac{N}{8} \right) - 1$$

and  $S = N - 8(A + 1)$

where  $N = 16$  to  $519$

For a valid division ratio N, the A counter and S counter must satisfy the condition:  $A + 1 \geq S$

Therefore,  $N = 16$  to  $54$  will result into non-continuous division ratio

and  $N = 56$  to  $519$  will be continuous division ratio.

Example: Given a reference frequency,  $F_{\text{ref}} = 11$  MHz, and VCO output frequency,  $F_{\text{vco}} = (198$  to  $297)$  MHz, results in  $N = 18$  to  $27$ . The decimal value of A counter and S counter for  $N = 18$  will be:

$$A = \text{int} \left( \frac{18}{8} \right) - 1 = 1$$

and  $S = 18 - 8(1 + 1) = 2$

Since the calculated value of A and S satisfy the condition of  $A + 1 \geq S$ , the  $N = 18$  is usable division ratio.

The division ratio,  $N = 23$ , however, will result in  $A = 1$  and  $S = 7$ . Under the condition  $A + 1 \geq S$ , the division ratio  $N = 23$  is not usable.

In this example, the division ratio,  $N = 19$  to  $23$  cannot be programmed and therefore, the frequency range of  $209$  MHz to  $253$  MHz cannot be used.

**HMC699LP5(E) Programming Truth Table, Continuous Division Ratios**

| Division Ratio N | A Counter Decimal Set | Swallow S Decimal Set | (LSB) A0 | A1 | A2 | A3 | A4 | A5 | (LSB) S0 | S1 | S2 |
|------------------|-----------------------|-----------------------|----------|----|----|----|----|----|----------|----|----|
| 56               | 6                     | 0                     | 0        | 1  | 1  | 0  | 0  | 0  | 0        | 0  | 0  |
| 57               | 6                     | 1                     | 0        | 1  | 1  | 0  | 0  | 0  | 1        | 0  | 0  |
| 58               | 6                     | 2                     | 0        | 1  | 1  | 0  | 0  | 0  | 0        | 1  | 0  |
| 59               | 6                     | 3                     | 0        | 1  | 1  | 0  | 0  | 0  | 1        | 1  | 0  |
| 60               | 6                     | 4                     | 0        | 1  | 1  | 0  | 0  | 0  | 0        | 0  | 1  |
| 61               | 6                     | 5                     | 0        | 1  | 1  | 0  | 0  | 0  | 0        | 0  | 1  |
| 62               | 6                     | 6                     | 0        | 1  | 1  | 0  | 0  | 0  | 0        | 1  | 1  |
| 63               | 6                     | 7                     | 0        | 1  | 1  | 0  | 0  | 0  | 1        | 1  | 1  |
| 64               | 7                     | 0                     | 1        | 1  | 1  | 0  | 0  | 0  | 0        | 0  | 0  |
| 65               | 7                     | 1                     | 1        | 1  | 1  | 0  | 0  | 0  | 1        | 0  | 0  |
| 66               | 7                     | 2                     | 1        | 1  | 1  | 0  | 0  | 0  | 0        | 1  | 0  |
| 67               | 7                     | 3                     | 1        | 1  | 1  | 0  | 0  | 0  | 1        | 1  | 0  |

**7 GHz INTEGER N SYNTHESIZER  
CONTINUOUS (N = 56 - 519), NON-CONTINUOUS (N = 16 - 54)**
**HMC699LP5(E) Programming Truth Table, Continuous Division Ratios (Continued)**

| Division Ratio N | A Counter Decimal Set | Swallow S Decimal Set | (LSB) A0 | A1 | A2 | A3 | A4 | A5 | (LSB) S0 | S1 | S2 |
|------------------|-----------------------|-----------------------|----------|----|----|----|----|----|----------|----|----|
| ⋮                | ⋮                     | ⋮                     | ⋮        | ⋮  | ⋮  | ⋮  | ⋮  | ⋮  | ⋮        | ⋮  | ⋮  |
| 512              | 63                    | 0                     | 1        | 1  | 1  | 1  | 1  | 1  | 0        | 0  | 0  |
| 513              | 63                    | 1                     | 1        | 1  | 1  | 1  | 1  | 1  | 1        | 0  | 0  |
| 514              | 63                    | 2                     | 1        | 1  | 1  | 1  | 1  | 1  | 0        | 1  | 0  |
| 515              | 63                    | 3                     | 1        | 1  | 1  | 1  | 1  | 1  | 1        | 1  | 0  |
| 516              | 63                    | 4                     | 1        | 1  | 1  | 1  | 1  | 1  | 0        | 0  | 1  |
| 517              | 63                    | 5                     | 1        | 1  | 1  | 1  | 1  | 1  | 1        | 0  | 1  |
| 518              | 63                    | 6                     | 1        | 1  | 1  | 1  | 1  | 1  | 0        | 1  | 1  |
| 519              | 63                    | 7                     | 1        | 1  | 1  | 1  | 1  | 1  | 1        | 1  | 1  |

**HMC699LP5(E) Programming Truth Table, Non-Continuous Division Ratios**

| Division Ratio N | A Counter Decimal Set | Swallow S Decimal Set | (LSB) A0 | A1 | A2 | A3 | A4 | A5 | (LSB) S0 | S1 | S2 |
|------------------|-----------------------|-----------------------|----------|----|----|----|----|----|----------|----|----|
| 16               | 1                     | 0                     | 1        | 0  | 0  | 0  | 0  | 0  | 0        | 0  | 0  |
| 17               | 1                     | 1                     | 1        | 0  | 0  | 0  | 0  | 0  | 1        | 0  | 0  |
| 18               | 1                     | 2                     | 1        | 0  | 0  | 0  | 0  | 0  | 0        | 1  | 0  |
| 24               | 2                     | 0                     | 0        | 1  | 0  | 0  | 0  | 0  | 0        | 0  | 0  |
| 25               | 2                     | 1                     | 0        | 1  | 0  | 0  | 0  | 0  | 1        | 0  | 0  |
| 26               | 2                     | 2                     | 0        | 1  | 0  | 0  | 0  | 0  | 0        | 1  | 0  |
| 27               | 2                     | 3                     | 0        | 1  | 0  | 0  | 0  | 0  | 1        | 1  | 0  |
| 32               | 3                     | 0                     | 1        | 1  | 0  | 0  | 0  | 0  | 0        | 0  | 0  |
| 33               | 3                     | 1                     | 1        | 1  | 0  | 0  | 0  | 0  | 1        | 0  | 0  |
| 34               | 3                     | 2                     | 1        | 1  | 0  | 0  | 0  | 0  | 0        | 1  | 0  |
| 35               | 3                     | 3                     | 1        | 1  | 0  | 0  | 0  | 0  | 1        | 1  | 0  |
| 36               | 3                     | 4                     | 1        | 1  | 0  | 0  | 0  | 0  | 0        | 0  | 1  |
| 40               | 4                     | 0                     | 0        | 0  | 1  | 0  | 0  | 0  | 0        | 0  | 0  |
| 41               | 4                     | 1                     | 0        | 0  | 1  | 0  | 0  | 0  | 1        | 0  | 0  |
| 42               | 4                     | 2                     | 0        | 0  | 1  | 0  | 0  | 0  | 0        | 1  | 0  |
| 43               | 4                     | 3                     | 0        | 0  | 1  | 0  | 0  | 0  | 1        | 1  | 0  |
| 44               | 4                     | 4                     | 0        | 0  | 1  | 0  | 0  | 0  | 0        | 0  | 1  |
| 45               | 4                     | 5                     | 0        | 0  | 1  | 0  | 0  | 0  | 1        | 0  | 1  |
| 48               | 5                     | 0                     | 1        | 0  | 1  | 0  | 0  | 0  | 0        | 0  | 0  |
| 49               | 5                     | 1                     | 1        | 0  | 1  | 0  | 0  | 0  | 1        | 0  | 0  |
| 50               | 5                     | 2                     | 1        | 0  | 1  | 0  | 0  | 0  | 0        | 1  | 0  |
| 51               | 5                     | 3                     | 1        | 0  | 1  | 0  | 0  | 0  | 1        | 1  | 0  |
| 52               | 5                     | 4                     | 1        | 0  | 1  | 0  | 0  | 0  | 0        | 0  | 1  |
| 53               | 5                     | 5                     | 1        | 0  | 1  | 0  | 0  | 0  | 1        | 0  | 1  |
| 54               | 5                     | 6                     | 1        | 0  | 1  | 0  | 0  | 0  | 0        | 1  | 1  |

\* Choose values of R2 & R4 between 4.3 and 20 Ohms for best noise performance.





**7 GHz INTEGER N SYNTHESIZER  
CONTINUOUS (N = 56 - 519), NON-CONTINUOUS (N = 16 - 54)**

**Evaluation PCB Circuit**

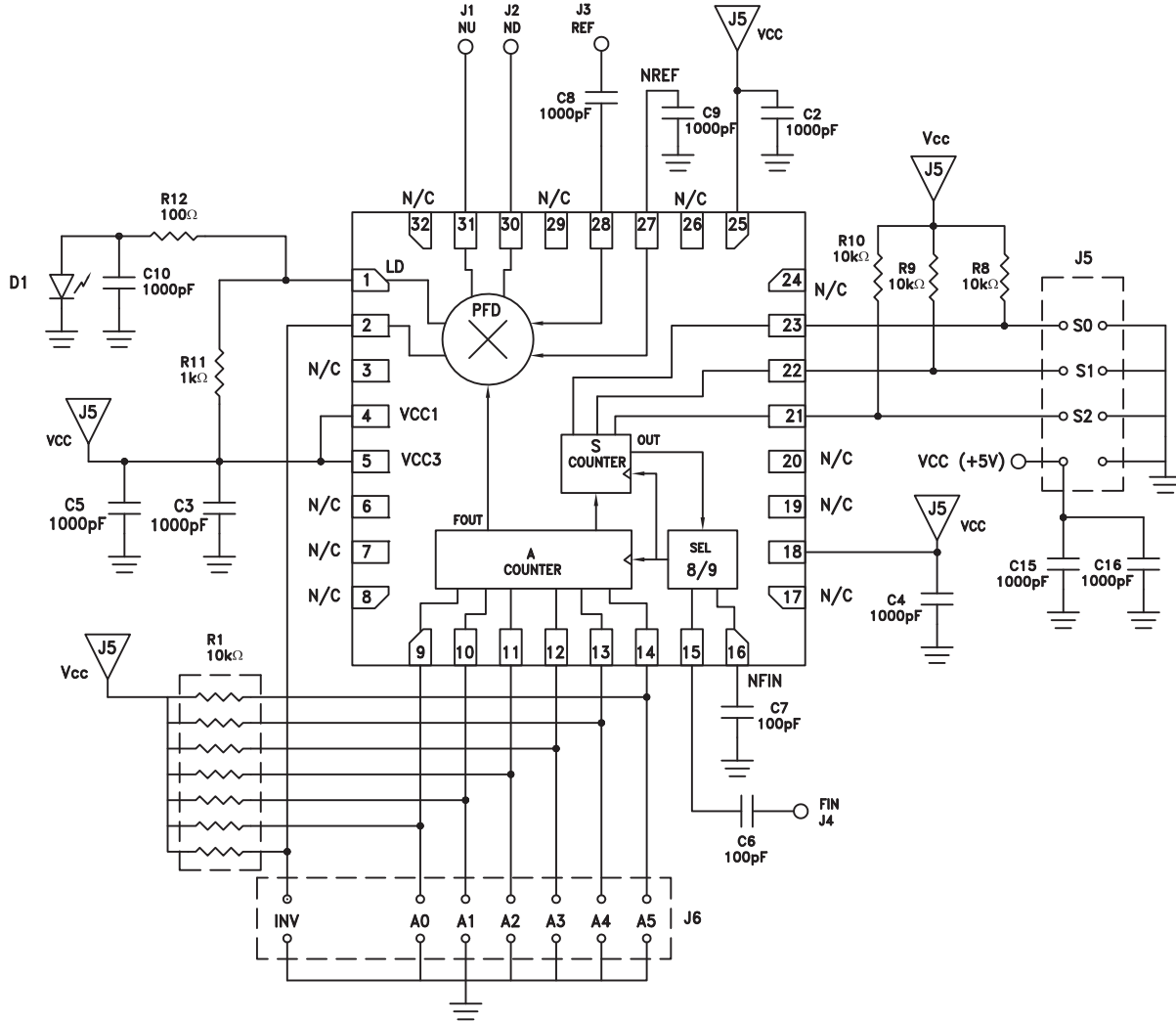

6

PLL - INTEGER-N SYNTHESIZER - SMT

Information furnished by Analog Devices is believed to be accurate and reliable. However, no responsibility is assumed by Analog Devices for its use, nor for any infringements of patents or other rights of third parties that may result from its use. Specifications subject to change without notice. No license is granted by implication or otherwise under any patent or patent rights of Analog Devices. Trademarks and registered trademarks are the property of their respective owners.

For price, delivery, and to place orders: Analog Devices, Inc., One Technology Way, P.O. Box 9106, Norwood, MA 02062-9106 Phone: 781-329-4700 • Order online at [www.analog.com](http://www.analog.com) Application Support: Phone: 1-800-ANALOG-D



**7 GHz INTEGER N SYNTHESIZER  
CONTINUOUS (N = 56 - 519), NON-CONTINUOUS (N = 16 - 54)**

**Evaluation PCB**

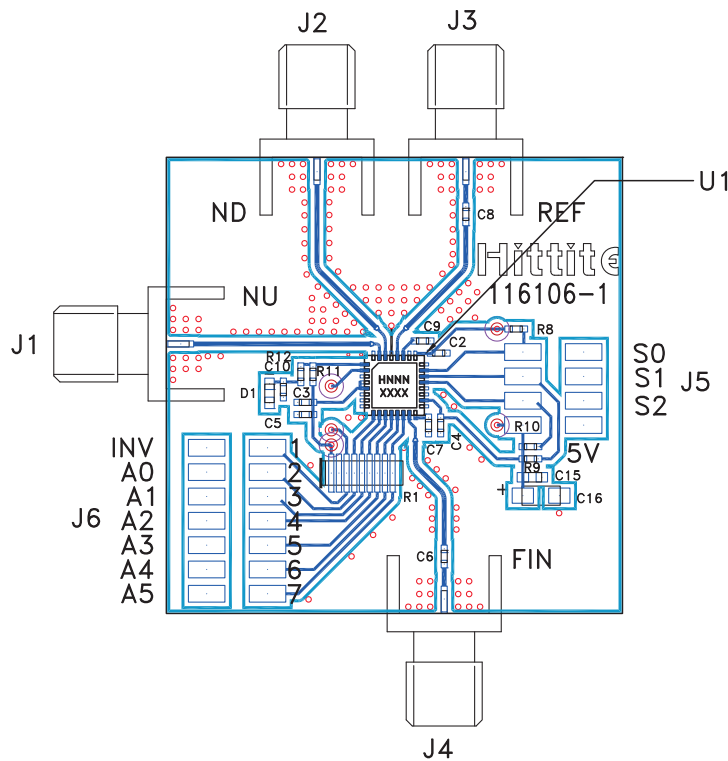

The circuit board used in the application should use RF circuit design techniques. Signal lines should have 50 Ohm impedance while the package backside ground paddle should be connected directly to the ground plane similar to that shown. A sufficient number of via holes should be used to connect the top and bottom ground planes. The evaluation circuit board shown is available from Hittite upon request.

**List of Materials for  
Evaluation PCB 116108 [1]**

| Item              | Description                      |
|-------------------|----------------------------------|
| J1 - J4           | PC Mount SMA RF Connector        |
| J5 - J6           | 2mm DC Header                    |
| C1 - C5, C8 - C10 | 1000 pF Capacitor, 0402 Pkg.     |
| C6 - C7           | 100 pF Capacitor, 0402 Pkg.      |
| C15               | 1000 pF Capacitor, 0603 Pkg.     |
| C16               | 4.7 μF Tantalum Capacitor Case A |
| D                 | LED Green, 0603 Pkg., +5V        |
| R1                | 10k Ohm, Resistor, Array         |
| R8, R10           | 10k Ohm, Resistor, 0402 Pkg.     |
| R11               | 1k Ohm, Resistor, 0402 Pkg.      |
| R12               | 100 Ohm, Resistor, 0402 Pkg.     |
| U1                | HMC699LP5(E) Synthesizer         |
| PCB [2]           | 116106 Eval Board                |

[1] Reference this number when ordering complete evaluation PCB

[2] Circuit Board Material: Rogers 4350

**Evaluation PCB Truth Table  
(see Programming Truth Table)**

Note: 0 = Jumper Installed.  
1 = Jumper Not Installed.

Note: The evaluation PCB for the HMC699LP5(E) contains 10 kOhm pull up resistors for each of the control inputs A0 through A5 and S0 through S2. Programming the 489 distinct division ratios consists of installing or removing jumpers A0 through A5 and S0 though S2.



**7 GHz INTEGER N SYNTHESIZER  
CONTINUOUS (N = 56 - 519), NON-CONTINUOUS (N = 16 - 54)**

**Typical PLL Application Circuit using HMC699LP5**

PLL application shown for a 13 GHz Fout. Contact HMC to discuss your specific application.

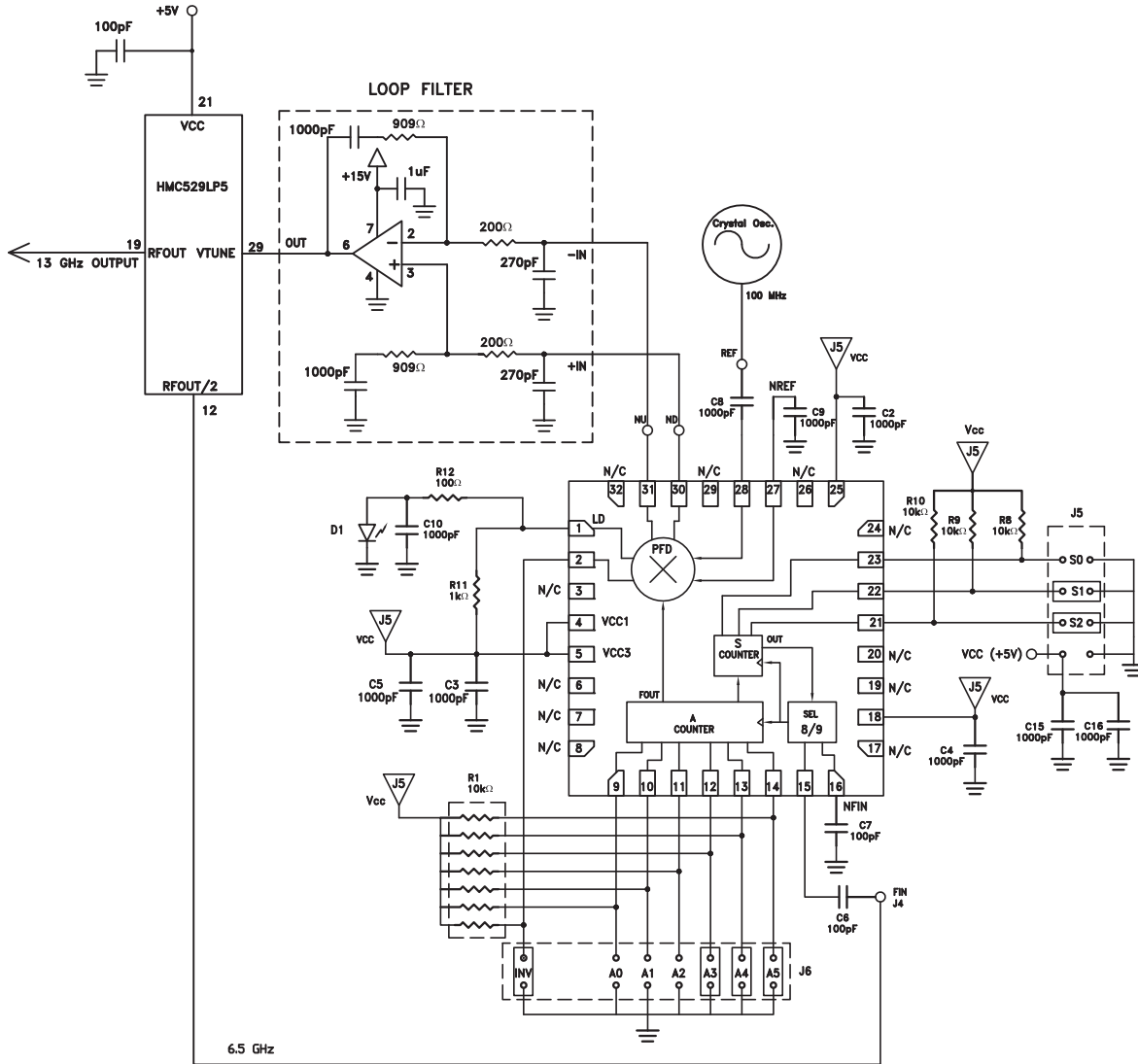



**7 GHz INTEGER N SYNTHESIZER  
CONTINUOUS (N = 56 - 519), NON-CONTINUOUS (N = 16 - 54)**

**Typical Application  
Showing Spurious Performance**

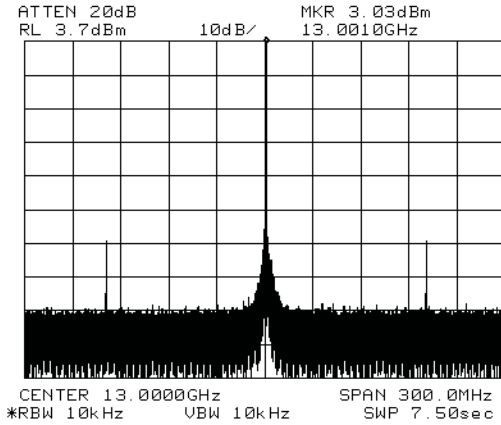

**Typical Application  
13 GHz Measured Phase Noise [1]**

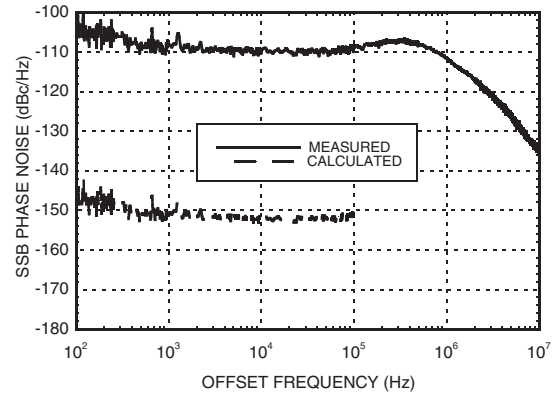

[1] Phase Noise Floor remains constant beyond 100 kHz offset frequency. Measured phase noise using Agilent 5500 with 2 unit measurement technique and corresponding calculated phase noise floor.

**CMOS/TTL Input Characteristics**

Maximum Input Logic "0" Voltage ( $V_{IL\ MAXIMUM}$ ) = 1.1V @ 1  $\mu$ A.

Minimum Input Logic "1" Voltage ( $V_{IH\ MINIMUM}$ ) = 1.8V @ 50  $\mu$ A.

Input IV characteristics for the logic inputs (A0 - A5 and S0 - S2) are shown below:

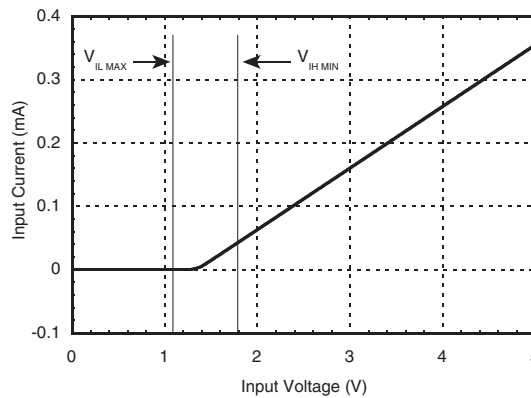

Information furnished by Analog Devices is believed to be accurate and reliable. However, no responsibility is assumed by Analog Devices for its use, nor for any infringements of patents or other rights of third parties that may result from its use. Specifications subject to change without notice. No license is granted by implication or otherwise under any patent or patent rights of Analog Devices. Trademarks and registered trademarks are the property of their respective owners.

For price, delivery, and to place orders: Analog Devices, Inc., One Technology Way, P.O. Box 9106, Norwood, MA 02062-9106 Phone: 781-329-4700 • Order online at [www.analog.com](http://www.analog.com) Application Support: Phone: 1-800-ANALOG-D

## X-ON Electronics

Largest Supplier of Electrical and Electronic Components

*Click to view similar products for [Phase Locked Loops - PLL category](#):*

*Click to view products by [Analog Devices manufacturer](#):*

Other Similar products are found below :

[CPLL58-2400-2500](#) [MB15E07SLPFV1-G-BND-6E1](#) [PI6C2409-1HWEX](#) [BA4116FV-E2](#) [HMC764LP6CETR](#) [HMC820LP6CETR](#)  
[CY22050KFI](#) [LMX2430TMX/NOPB](#) [NB3N5573DTG](#) [ADF4153ABCPZ](#) [PI6C2405A-1LE](#) [CD74HC4046AM](#) [CPLL66-2450-2450](#)  
[NJM567D](#) [74HC4046ADB.112](#) [74HC4046APW.112](#) [CY23S05SXI-1](#) [STW81200T](#) [ADF4208BRUZ](#) [ADF4218LBRUZ](#) [ADF4355-3BCPZ](#)  
[ADF4355BCPZ](#) [ADF4169WCCPZ](#) [ADF4360-6BCPZ](#) [ADF4360-5BCPZRL7](#) [ADF4360-5BCPZ](#) [ADF4360-4BCPZRL7](#) [ADF4360-4BCPZ](#)  
[ADF4360-3BCPZ](#) [ADF4360-2BCPZRL7](#) [ADF4252BCPZ](#) [ADF4159CCPZ](#) [ADF4169CCPZ](#) [ADF4360-0BCPZ](#) [ADF4360-1BCPZ](#) [ADF4360-1BCPZRL7](#) [ADF4360-2BCPZ](#) [ADF4360-3BCPZRL7](#) [ADF4360-7BCPZRL7](#) [ADF4360-8BCPZ](#) [ADF4360-8BCPZRL7](#) [ADF4360-9BCPZ](#)  
[ADF4360-9BCPZRL7](#) [ADF4159CCPZ-RL7](#) [ADF4159WCCPZ](#) [ADF4360-0BCPZRL7](#) [AD9901KPZ](#) [AD9901KQ](#) [ADF4001BCPZ](#)  
[ADF4002BCPZ](#)