



54 dB, LOGARITHMIC DETECTOR / CONTROLLER, 45 - 2700 MHz

Typical Applications

The HMC713MS8(E) is ideal for:

- Cellular Infrastructure
- WiMAX, WiBro & LTE/4G
- Power Monitoring & Control Circuitry
- Receiver Signal Strength Indication (RSSI)
- Automatic Gain & Power Control
- Military, ECM & Radar

Features

- Wide Dynamic Range: up to 54 dB
- High Accuracy:
±1 dB with 54 dB Range Up To 2.7 GHz
- Fast Output Response Time
- Supply Voltage: +2.7 to +5.5V
- Power-Down Mode
- Excellent Stability over Temperature
- MSOP-8 SMT Package: 14.8 mm²

Functional Diagram

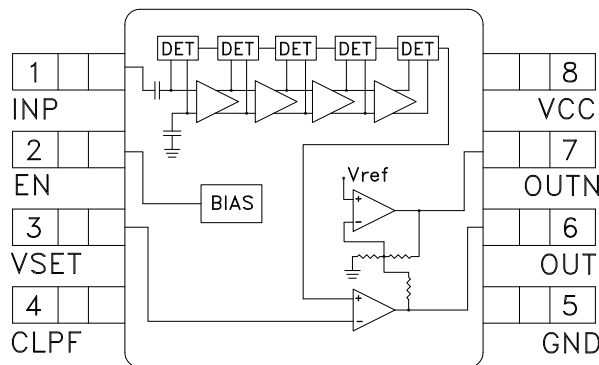

General Description

The HMC713MS8(E) Logarithmic Detector/Controller is ideal for converting RF signals with frequencies in the 45 MHz to 2700 MHz range, to a proportional DC voltage at its output. The HMC713MS8(E) employs a successive compression technology which delivers 54 dB of dynamic range with high conversion accuracy over a wide input frequency range. As the input signal is increased, successive amplifiers move into saturation one by one creating an accurate approximation of the logarithm function. The outputs of a series of detectors are summed, converted into voltage domain and buffered to drive the OUT output. For detection mode, the OUT pin is connected to the VSET input and will provide a nominal logarithmic slope of 17 mV/dB and an intercept of -68 dBm. The HMC713MS8(E) can also be used in the controller mode where an external voltage is applied to the VSET pin to create an AGC or APC feedback loop.

Electrical Specifications, $T_A = +25\text{ }^\circ\text{C}$, $V_{CC} = +3V$ [1]

| Parameter | Typ. | Typ. | Typ. | Typ. | Typ. | Typ. | Units |
|---|------|------|------|------|------|------|-------|
| Input Frequency | 45 | 100 | 900 | 1900 | 2200 | 2700 | MHz |
| ±3 dB Dynamic Range | 60 | 61 | 61 | 62 | 62 | 68 | dB |
| ±3 dB Dynamic Range Center | -26 | -28 | -28 | -30 | -31 | -27 | dBm |
| ±1 dB Dynamic Range | 53 | 54 | 54 | 54 | 53 | 59 | dB |
| OUT Slope | 17.3 | 17.3 | 17.2 | 17.1 | 17.1 | 17.2 | mV/dB |
| OUT Intercept | -68 | -68 | -69 | -71 | -72 | -70 | dBm |
| Variation of OUT with Temperature from -40°C to +85°C @ -20 dBm Input | -0.8 | -1 | -0.9 | -0.5 | -0.6 | -0.5 | dB |

[1] Detector mode measurements; OUT (Pin 6) is shorted to VSET (Pin 3) through an RC network.



**54 DB, LOGARITHMIC
DETECTOR / CONTROLLER, 45 - 2700 MHz**
Electrical Specifications, (continued)

| Parameter | Conditions | Min. | Typ. | Max. | Units |
|-----------------------------------|--|-----------|-------------------|-----------|-------|
| Power Down (EN) Interface | | | | | |
| Voltage Range for Normal Mode | | 0.8 x Vcc | | | V |
| Voltage Range for Powerdown Mode | | | | 0.2 x Vcc | V |
| Threshold Voltage | | | Vcc/2 | | V |
| Power Supply (Vcc) | | | | | |
| Operating Voltage Range | | | 2.7 - 5.5 | | V |
| Supply Current in Normal Mode | | | 17 | | mA |
| Supply Current in Power Down Mode | | | 0.3 | | mA |
| OUT Interface | | | | | |
| Rise Time | CLPF= 0, No Power to -10 dBm, 10% - 90% | | 24 | | ns |
| Fall Time | CLPF= 0, -10 dBm to No Power, 90% - 10% | | 70 | | ns |
| Output Video BW | 3 dB reduction in demodulated output voltage | | 16 | | MHz |
| Voltage Range | Closed Loop (Eval Board Setup) | | 0.2 - 1.2 | | V |
| Voltage Range | Open Loop | | 0.1 to (Vcc -0.1) | | V |
| Current Drive Source / Sink | | | 3.5 / 0.51 | | mA |
| OUTN Interface | | | | | |
| Current Drive Source / Sink | | | 3.6 / 0.47 | | mA |
| OUTN Interface | | | | | |
| Output Voltage Range | | | 0.2 - 2.1 | | V |
| RF Input | | | | | |
| Input Return Loss (S11) | F= 50 MHz to 2.5 GHz Z ₀ = 50Ω, See plot | | 10 | | dB |
| VSET Interface | | | | | |
| Input Impedance | | | 1 | | MΩ |
| Input Voltage Range | Eval Board | | 0.2 - 1.2 | | V |
| Low Frequency Gain | VSET to OUT | | 64 | | dB |
| Open Loop Corner Frequency | | | 11 | | kHz |

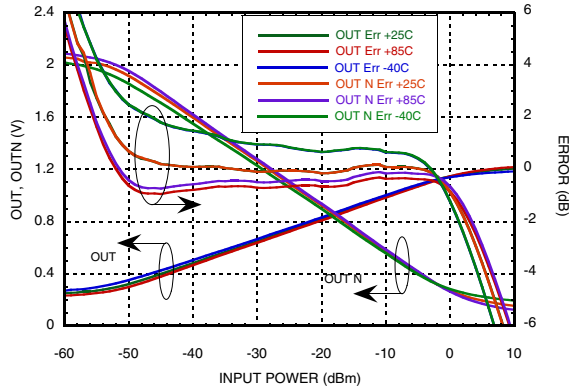

**54 DB, LOGARITHMIC
DETECTOR / CONTROLLER, 45 - 2700 MHz**

**Output Voltage & Error
vs. Input Power, $F_{in} = 45$ MHz**



**Output Voltage & Error
vs. Input Power, $F_{in} = 100$ MHz**

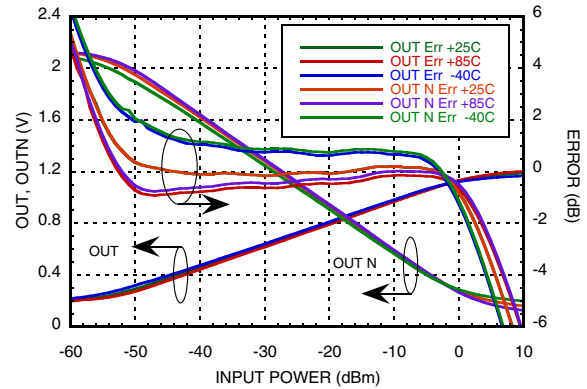

**Output Voltage & Error
vs. Input Power, $F_{in} = 900$ MHz**

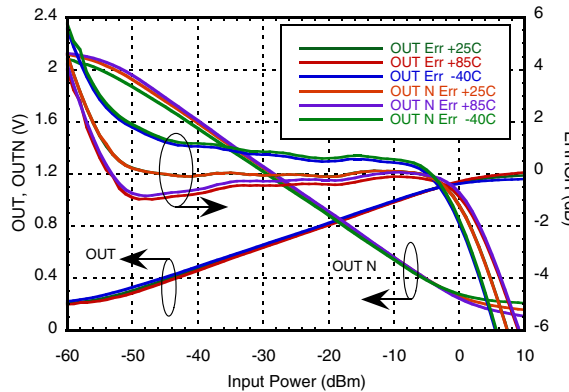

**Output Voltage & Error
vs. Input Power, $F_{in} = 1900$ MHz**

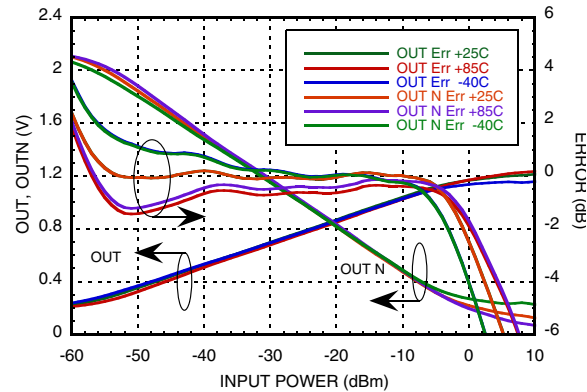

**Output Voltage & Error
vs. Input Power, $F_{in} = 2200$ MHz**

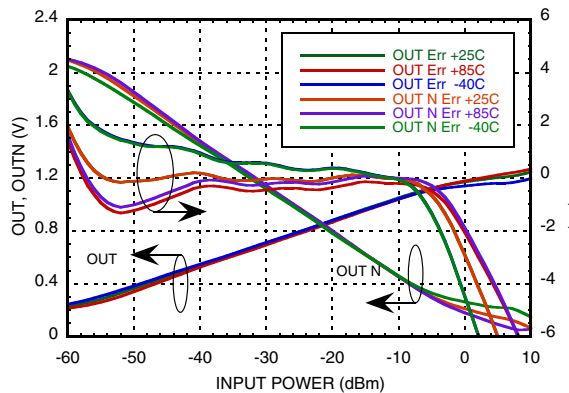

**Output Voltage & Error
vs. Input Power, $F_{in} = 2700$ MHz**

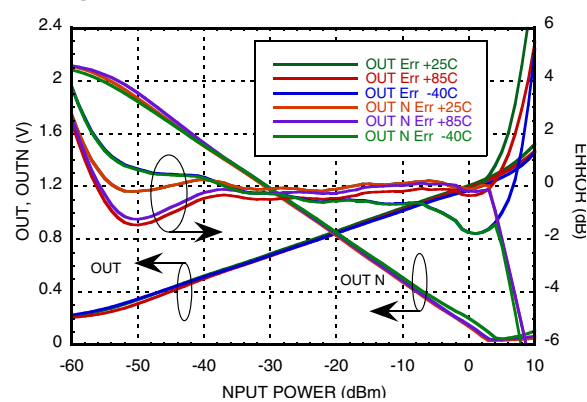

Unless otherwise noted: $V_{cc} = +3V$, $T_A = +25^\circ C$

Information furnished by Analog Devices is believed to be accurate and reliable. However, no responsibility is assumed by Analog Devices for its use, nor for any infringements of patents or other rights of third parties that may result from its use. Specifications subject to change without notice. No license is granted by implication or otherwise under any patent or patent rights of Analog Devices. Trademarks and registered trademarks are the property of their respective owners.

For price, delivery, and to place orders: Analog Devices, Inc., One Technology Way, P.O. Box 9106, Norwood, MA 02062-9106 Phone: 781-329-4700 • Order online at www.analog.com Application Support: Phone: 1-800-ANALOG-D



54 DB, LOGARITHMIC DETECTOR / CONTROLLER, 45 - 2700 MHz

OUT Slope vs. Frequency

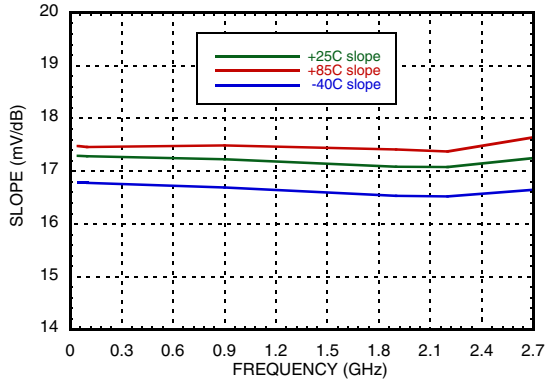

OUT Slope vs. Supply Voltage

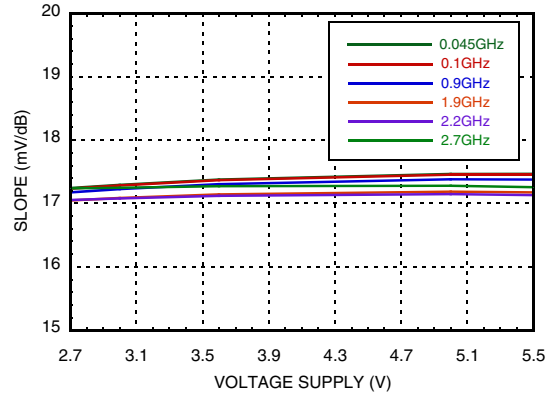

OUT Intercept vs. Frequency

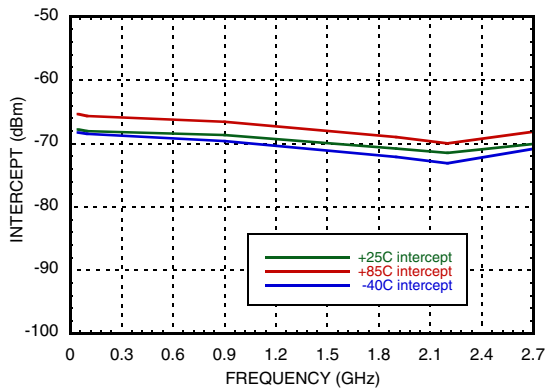

OUT Intercept vs. Supply Voltage

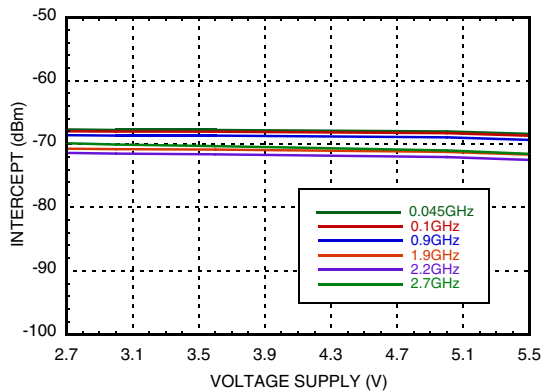

OUT vs. Frequency & Input Power

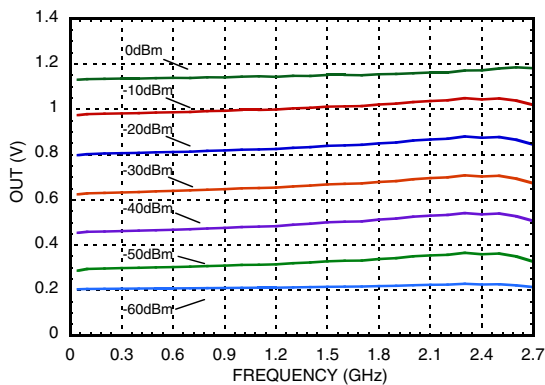

OUT Voltage & Error vs. Frequency

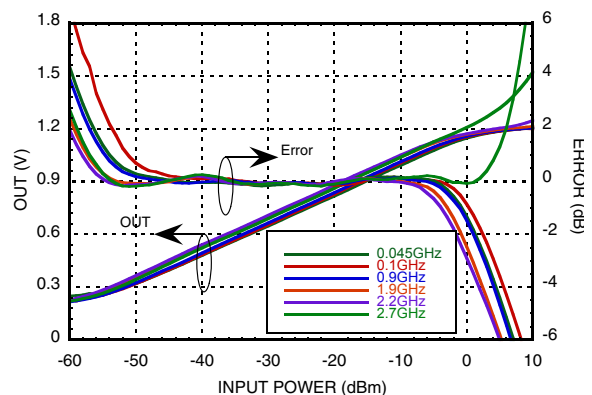

Unless otherwise noted: $V_{cc} = +3V$, $T_A = +25^\circ C$

Information furnished by Analog Devices is believed to be accurate and reliable. However, no responsibility is assumed by Analog Devices for its use, nor for any infringements of patents or other rights of third parties that may result from its use. Specifications subject to change without notice. No license is granted by implication or otherwise under any patent or patent rights of Analog Devices. Trademarks and registered trademarks are the property of their respective owners.

For price, delivery, and to place orders: Analog Devices, Inc., One Technology Way, P.O. Box 9106, Norwood, MA 02062-9106 Phone: 781-329-4700 • Order online at www.analog.com Application Support: Phone: 1-800-ANALOG-D



**54 DB, LOGARITHMIC
DETECTOR / CONTROLLER, 45 - 2700 MHz**

**Output Response
Fall Time @ 900 MHz, C1 = Open**

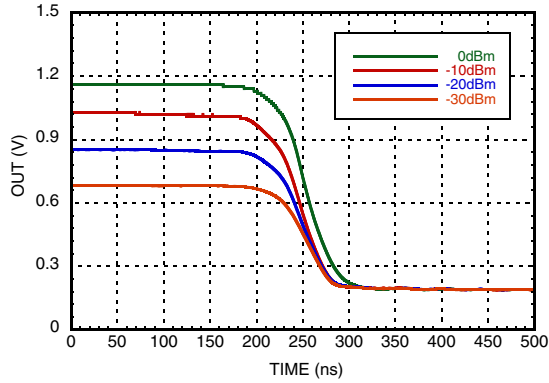

**Output Response
Fall Time @ 900 MHz, C1 = 10nF**

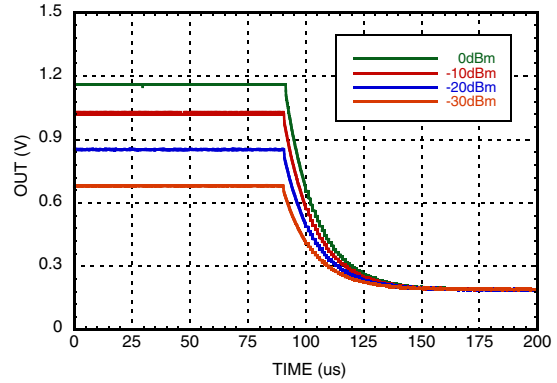

**Output Response
Rise Time @ 900 MHz, C1 = Open**

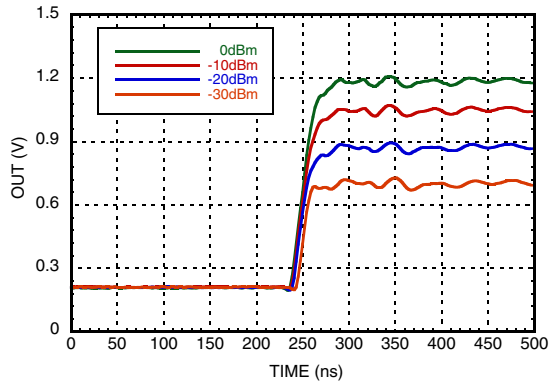

**Output Response
Rise Time @ 900 MHz, C1 = 10nF**

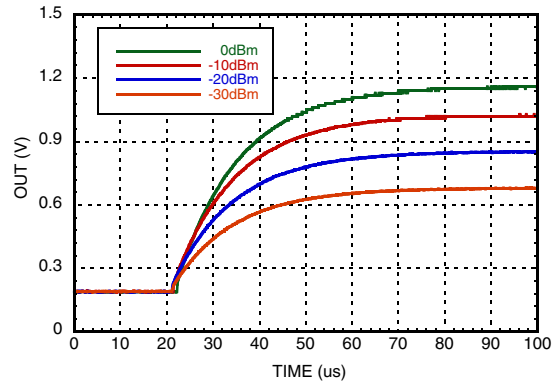

Input Return Loss

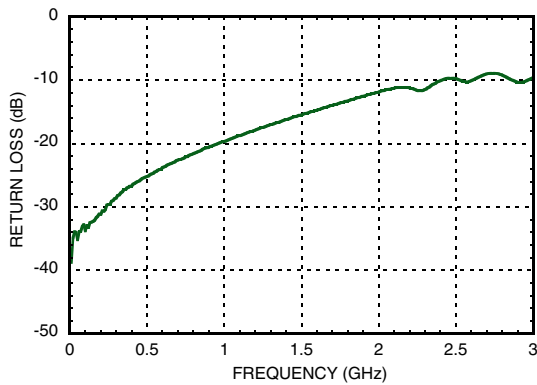

Unless otherwise noted: $V_{CC} = +3V$, $T_A = +25^\circ C$

Information furnished by Analog Devices is believed to be accurate and reliable. However, no responsibility is assumed by Analog Devices for its use, nor for any infringements of patents or other rights of third parties that may result from its use. Specifications subject to change without notice. No license is granted by implication or otherwise under any patent or patent rights of Analog Devices. Trademarks and registered trademarks are the property of their respective owners.

For price, delivery, and to place orders: Analog Devices, Inc., One Technology Way, P.O. Box 9106, Norwood, MA 02062-9106
Phone: 781-329-4700 • Order online at www.analog.com
Application Support: Phone: 1-800-ANALOG-D



54 DB, LOGARITHMIC DETECTOR / CONTROLLER, 45 - 2700 MHz

Absolute Maximum Ratings

| | |
|---|----------------|
| Vcc | 0 to +5.6V |
| EN | 0 to +5.6V |
| VSET | 0 to +5.6V |
| OUT Output Current | 5 mA |
| OUTN Output Current | 5 mA |
| RF Input Power | 12 dBm |
| Junction Temperature | 125 °C |
| Continuous P _{diss} (T = 85°C) (Derate 5.43 mW/°C above 85°C) | 0.22 Watts |
| Thermal Resistance (R _{th}) (junction to lead) | 184 °C/W |
| Storage Temperature | -65 to +150 °C |
| Operating Temperature | -40 to +85 °C |
| ESD Sensitivity (HBM) | Class 1C |



ELECTROSTATIC SENSITIVE DEVICE
OBSERVE HANDLING PRECAUTIONS

Outline Drawing

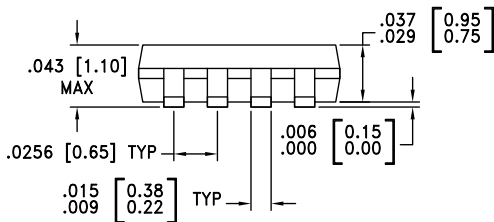
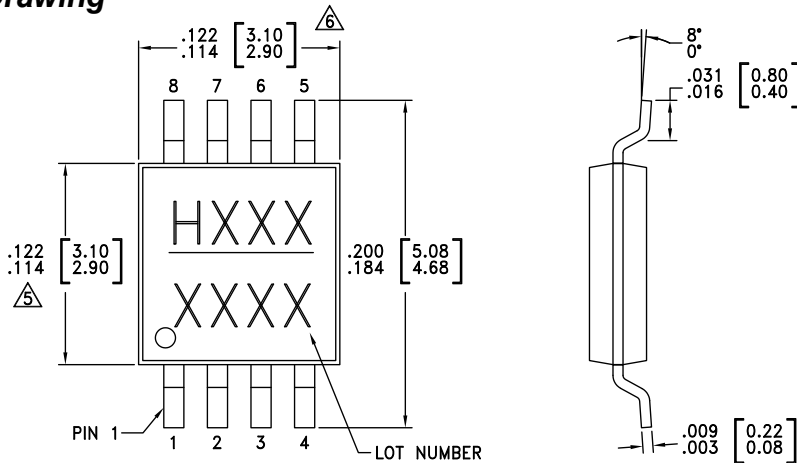

NOTES:

- PACKAGE BODY MATERIAL: LOW STRESS INJECTION MOLDED PLASTIC SILICA AND SILICON IMPREGNATED.
- LEAD MATERIAL: COPPER ALLOY
- LEAD PLATING: 100% MATTE TIN
- DIMENSIONS ARE IN INCHES [MILLIMETERS].
- DIMENSION DOES NOT INCLUDE MOLDFLASH OF 0.15mm PER SIDE.
- DIMENSION DOES NOT INCLUDE MOLDFLASH OF 0.25mm PER SIDE.
- ALL GROUND LEADS MUST BE SOLDERED TO PCB RF GROUND.

Package Information

| Part Number | Package Body Material | Lead Finish | MSL Rating | Package Marking ^[3] |
|-------------|--|---------------|---------------------|--------------------------------|
| HMC713MS8 | Low Stress Injection Molded Plastic | Sn/Pb Solder | MSL1 ^[1] | H713 XXXX |
| HMC713MS8E | RoHS-compliant Low Stress Injection Molded Plastic | 100% matte Sn | MSL1 ^[2] | H713 XXXX |

[1] Max peak reflow temperature of 235 °C

[2] Max peak reflow temperature of 260 °C

[3] 4-Digit lot number XXXX



54 DB, LOGARITHMIC DETECTOR / CONTROLLER, 45 - 2700 MHz

Pin Descriptions

| Pin Number | Function | Description | Interface Schematic |
|------------|----------|---|---------------------|
| 1 | INP | RF input pin. | |
| 2 | EN | <p>Enable pin.</p> <p>Apply $V_{EN} > 0.8 \times V_{CC}$ for normal operation.</p> <p>Apply $V_{EN} < 0.2 \times V_{CC}$ to disable the HMC713MS8E and reduce supply current to 0.3mA.</p> <p>To ensure proper start-up apply the power-up sequence shown in the "Power-Up Timing Diagram" attached to the application circuit.</p> | |
| 3 | VSET | <p>Set point input for controller mode.</p> <p>Connect to OUT with the resistor network shown in evaluation board drawing for detector mode.</p> | |
| 4 | CLPF | Connection for ground referenced external lowpass filter capacitor. | |
| 5 | GND | Device ground. | |



**54 DB, LOGARITHMIC
DETECTOR / CONTROLLER, 45 - 2700 MHz**

Pin Descriptions (Continued)

| Pin Number | Function | Description | Interface Schematic |
|------------|----------|---|---------------------|
| 6 | OUT | Logarithmic output that converts the input power to a DC level in controller mode. Output voltage increases with increasing amplitude | |
| 7 | OUTN | Inverted logarithmic output. $OUTN = 2.55 - 2 \times OUT$ | |
| 8 | Vcc | Bias Supply. Connect supply voltage to all this pin with appropriate filtering. | |



**54 DB, LOGARITHMIC
DETECTOR / CONTROLLER, 45 - 2700 MHz**

Application & Evaluation PCB Schematic

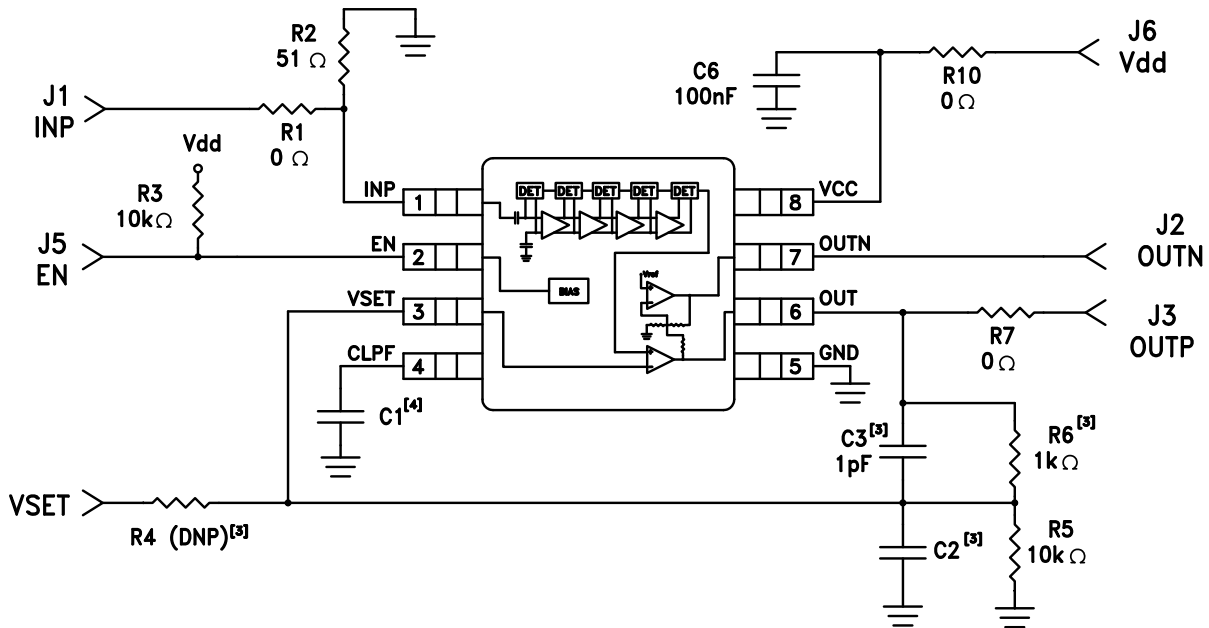

Notes

- Note 1: The HMC713MS8(E) evaluation board is pre-assembled for single-ended input, and detector/RSSI mode.
- Note 2: For detector mode, connect high impedance volt meter to the OUT / OUTN port.
- Note 3: For controller mode, remove R6 & C3 and install 1k Ω resistor (R4) and 100pF capacitor (C2), then make appropriate connection to OUT and VSET. In controller mode, the OUT / OUTN output can be used to drive a variable gain amplifier, or a variable attenuator, either directly or through a buffer or microcontroller. VSET should be connected to an external supply, typically between +0.2 and +1.2V.
- Note 4: An external capacitance C1 can be connected to CLPF port for additional filtering of OUT and OUTN outputs..

Power-Up Timing Diagram

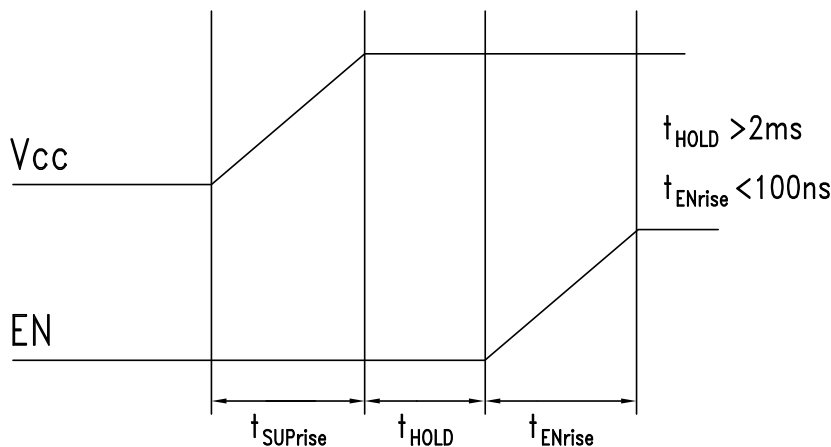



**54 DB, LOGARITHMIC
DETECTOR / CONTROLLER, 45 - 2700 MHz**

Evaluation PCB

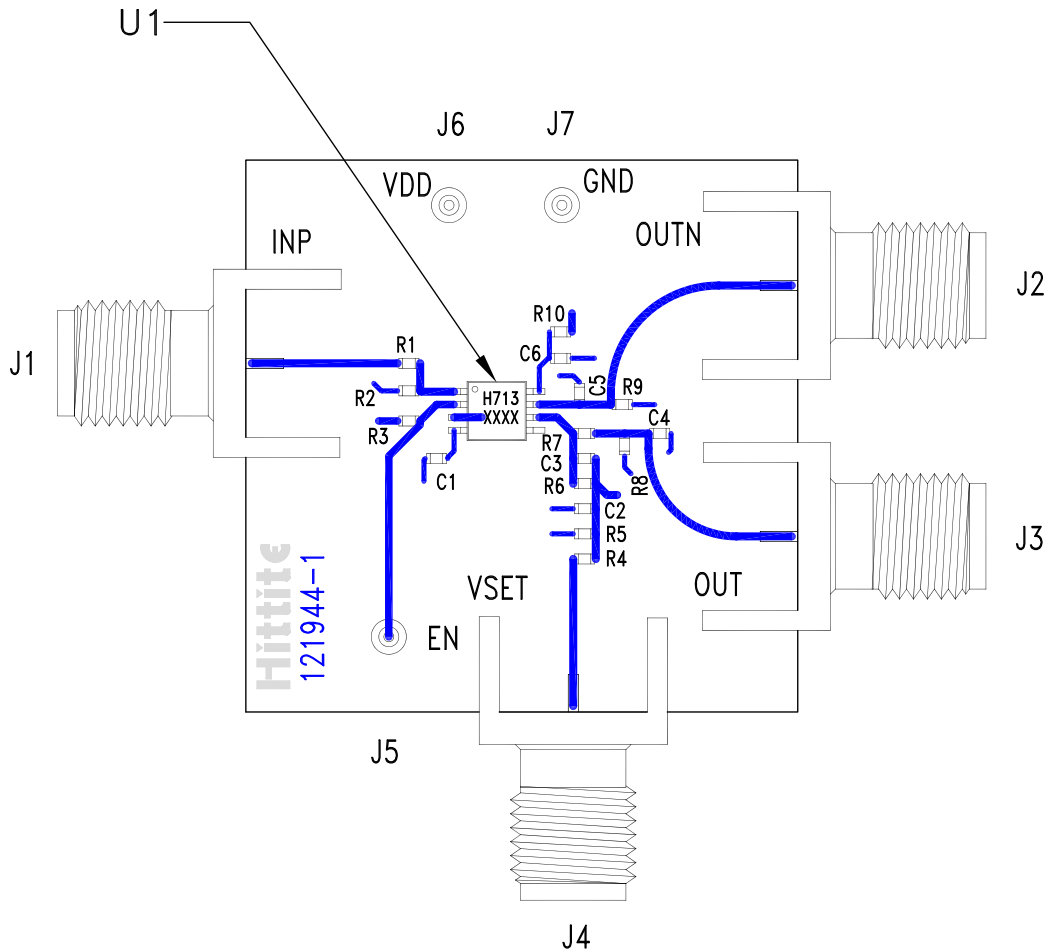

List of Materials for Evaluation PCB 121947 [1]

| Item | Description |
|-------------|---|
| J1 - J3 | PC Mount SMA Connector |
| J5 - J7 | DC Pin |
| C3 | 1 pF Capacitor, 0402 Pkg. |
| C6 | 0.1 μ F Capacitor, 0402 Pkg. |
| R1, R7, R10 | 0 Ω Resistor, 0402 Pkg. |
| R2 | 51 Ω Resistor, 0402 Pkg. |
| R3, R5 | 10k Resistor, 0402 Pkg. |
| R6 | 1k Resistor, 0402 Pkg. |
| U1 | HMC713MS8(E) Logarithmic Detector / Controller |
| PCB [2] | 121944 Evaluation PCB |

The circuit board used in the application should use RF circuit design techniques. Signal lines should have 50 ohm impedance while the package ground leads and exposed paddle should be connected directly to the ground plane similar to that shown. A sufficient number of via holes should be used to connect the top and bottom ground planes. The evaluation circuit board shown is available from Hittite upon request.

[1] Reference this number when ordering complete evaluation PCB

[2] Circuit Board Material: Arlon 25FR or Rogers 4350

X-ON Electronics

Largest Supplier of Electrical and Electronic Components

Click to view similar products for [RF Detector](#) category:

Click to view products by [Analog Devices](#) manufacturer:

Other Similar products are found below :

[HMC439QS16GTR](#) [HMC7447-SX](#) [MACP-010562-TR1000](#) [R451075000](#) [2085-6013-13](#) [2085-6010-00](#) [32-2018-BU](#) [32-3033-BU](#) [32-3203-BU](#) [AD8361ARMZ-REEL](#) [LT5534ESC6#TRPBF](#) [AD8361ARM-REEL7](#) [AD8314ARMZ-REEL](#) [AD8311ACBZ-P7](#) [AD8312ACBZ-P7](#) [AD8313ARMZ-REEL7](#) [AD8314ACPZ-RL7](#) [AD8314ARMZ](#) [AD8314ARMZ-REEL7](#) [AD8315ARMZ](#) [AD8317ACPZ-R7](#) [AD8319ACPZ-R7](#) [AD8361ARMZ](#) [AD8361ARMZ-REEL7](#) [AD8362ARUZ-REEL7](#) [AD8363ACPZ-R7](#) [AD8302ARUZ-RL7](#) [ADL5906ACPZN-R7](#) [ADL5500ACBZ-P7](#) [ADL5502ACBZ-P7](#) [ADL5504ACBZ-P7](#) [ADL5505ACBZ-P7](#) [ADL5506ACBZ-R7](#) [ADL5506WACBZ-R7](#) [ADL5513ACPZ-R7](#) [ADL5903ACPZN-R7](#) [ADL5903SCPZN-R7](#) [ADL6010ACPZN-R2](#) [ADL6010SCPZN](#) [ADL6010SCPZN-R7](#) [ADL6010SCPZN-R2](#) [ADL6012ACPZN](#) [ADL5511ACPZ-R7](#) [ADL5904ACPZN-R7](#) [ADL5910ACPZN-R7](#) [AD8364ACPZ-REEL7](#) [ADL5920ACPZ](#) [HMC1021LP4E](#) [HMC1120LP4E](#) [HMC1120LP4ETR](#)