

FEATURES

- Operation up to 32 Gbps
- Low dc power dissipation
 - 0.15 W for 1.5 V p-p swing at 3.5 V supply
 - 0.4 W for 2 V p-p swing at 5 V supply
- Adjustable output amplitude from 1.2 V p-p to 2.2 V p-p
- Integrated peak detector
- 24-lead, ceramic, 4 mm × 4 mm LCC package: 16 mm²

APPLICATIONS

- 100 Gbps Ethernet LR4 (10 km) and ER4 (40 km) applications
- C-form factor pluggable (CFP/CFP2) or similar form factor modules
- Optical transceivers and pluggable modules
- Broadband gain stages and preamplifiers
- Broadband test and measurement equipment

GENERAL DESCRIPTION

The **HMC7144** is a broadband driver amplifier for electro-absorption modulated lasers (EML). The device supports data rates up to 28 Gbps to meet 100 Gbps Ethernet system requirements. The device provides module designers with a scalable power dissipation for varying drive voltage characteristics of different modulators; the power consumption of the module can be set as low as 0.12 W to 0.5 W at 1.5 V p-p and 2.2 V p-p output amplitudes, respectively.

FUNCTIONAL BLOCK DIAGRAM

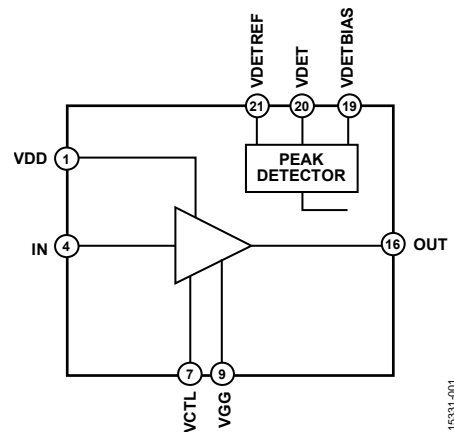

Figure 1.

15331-001

The **HMC7144** supports a wide range of supply voltages from 3.5 V to 7 V and delivers excellent time domain performance. The driver incorporates the unique peak detector with reference feature that enables continuous output amplitude monitoring without the need for external high frequency circuitry. The output amplitude and crosspoint are adjustable via control pins. The input and output are 50 Ω and require ac coupling.

The **HMC7144** is housed in a robust, leadless, 4 mm × 4 mm ceramic LCC package.

HMC7144* PRODUCT PAGE QUICK LINKS

Last Content Update: 02/23/2017

COMPARABLE PARTS

View a parametric search of comparable parts.

EVALUATION KITS

- HMC7144LC4 Evaluation Board

DESIGN RESOURCES

- HMC7144 Material Declaration
- PCN-PDN Information
- Quality And Reliability
- Symbols and Footprints

DISCUSSIONS

View all HMC7144 EngineerZone Discussions.

SAMPLE AND BUY

Visit the product page to see pricing options.

TECHNICAL SUPPORT

Submit a technical question or find your regional support number.

DOCUMENT FEEDBACK

Submit feedback for this data sheet.

TABLE OF CONTENTS

Features	1	Interface Schematics	7
Applications.....	1	Typical Performance Characteristics	8
Functional Block Diagram	1	Applications Information	11
General Description	1	Device Operation	11
Revision History	2	Device Power-Up.....	11
Specifications.....	3	Device Power-Down	11
3.5 V Electrical Specifications.....	3	Application Circuit.....	11
5.0 V Electrical Specifications.....	4	Evaluation Printed Circuit Board (PCB)	12
Typical Bias Voltages	4	Outline Dimensions	13
Absolute Maximum Ratings.....	5	Ordering Guide	13
ESD Caution.....	5		
Pin Configuration and Function Descriptions.....	6		

REVISION HISTORY

This Hittite Microwave Products data sheet has been reformatted to meet the styles and standards of Analog Devices, Inc.

12/2016—v02.0314 to Rev. C

Changes to Features, Applications, and General Description Section.....	1
Changes to Table 3.....	4
Changes to Table 4.....	5
Changes to Table 5.....	6
Changes to Device Power-Up Section	11

SPECIFICATIONS

3.5 V ELECTRICAL SPECIFICATIONS

$V_{DD} = 3.5 \text{ V}$, $T_A = 25^\circ\text{C}$, unless otherwise noted.

Table 1.

Parameter	Test Conditions/Comments	Min	Typ	Max	Unit	
MAXIMUM DATA RATE			28	32	Gbps	
GAIN	DC to 10 GHz	10	13	13.8	dB	
	10 GHz to 20 GHz	11.8	12.8	13.5	dB	
	20 GHz to 30 GHz	5.8	8.8	13	dB	
RETURN LOSS	Input	DC to 10 GHz	-13	-10	dB	
		10 GHz to 20 GHz	-16	-9	dB	
		20 GHz to 30 GHz	-18	-4	dB	
	Output	DC to 10 GHz	-23	-15	dB	
		10 GHz to 20 GHz	-21	-13	dB	
		20 GHz to 30 GHz	-18	-11	dB	
GROUP DELAY VARIATION	DC to 10 GHz		±5		ps	
	10 GHz to 20 GHz		±10		ps	
	20 GHz to 30 GHz		±22		ps	
ADJUSTABLE OUTPUT SWING RANGE	Data input = 28 Gbps nonreturn to zero (NRZ) pseudo-random binary sequence (PRBS) 23 ¹ – 1 pattern, 0.5 V p-p	0.9		1.5	V p-p	
TIMING	Data input = 28 Gbps NRZ PRBS 23 ¹ – 1 pattern, 0.5 V p-p	Rise		14.5	ps	
		Fall		16.2	ps	
JITTER	Data input = 28 Gbps NRZ PRBS 23 ¹ – 1 pattern, 0.5 V p-p	Additive RMS Jitter ¹	240	270	320	f _s
		Deterministic			2	ps
SIGNAL-TO-NOISE RATIO (SNR)	Data input = 28 Gbps NRZ PRBS 23 ¹ – 1 pattern, 0.5 V p-p		23		dB	
SUPPLY CURRENT (I_{DD})		40	45	55	mA	
BIAS CURRENT ADJUST/CROSSPOINT ADJUST		Bias Voltage (V_{GG})	-1.5	-0.9	-0.5	V
		Bias Current (I_{GG})			1	mA
OUTPUT AMPLITUDE ADJUST		Voltage (V_{CTL})	-1	-0.2	+0.5	V
		Current (I_{CTL})			1	mA
CROSSPOINT RANGE ²		45	50	55	%	
PEAK DETECT SENSITIVITY	$R_{LOAD} = 10 \text{ M}\Omega$ at VDET and VDETREF	75	85	95	mV/V	

¹ Additive rms jitter is calculated by $J_{RMS \text{ DUT}} = \sqrt{((J_{TESTED})^2 - (J_{SOURCE})^2)}$ with 28 Gbps 10101 ... pattern, 0.5 V p-p.

² Adjust V_{GG} between -1 V and 0 V to achieve the desired crosspoint percentage.

5.0 V ELECTRICAL SPECIFICATIONS

$V_{DD} = 5.0\text{ V}$, $T_A = 25^\circ\text{C}$, unless otherwise specified.

Table 2.

Parameter	Test Conditions/Comments	Min	Typ	Max	Unit	
MAXIMUM DATA RATE			28	32	Gbps	
GAIN	DC to 10 GHz	11	15	16	dB	
	10 GHz to 20 GHz	10	14	15	dB	
	20 GHz to 30 GHz	7	12	13	dB	
RETURN LOSS	Input	DC to 10 GHz	-13	-10	dB	
		10 GHz to 20 GHz	-14	-10	dB	
		20 GHz to 30 GHz	-16	-7	dB	
	Output	DC to 10 GHz	-23	-10	dB	
		10 GHz to 20 GHz	-21	-10	dB	
		20 GHz to 30 GHz	-15	-7	dB	
GROUP DELAY VARIATION	DC to 10 GHz		±6		ps	
	10 GHz to 20 GHz		±10		ps	
	20 GHz to 30 GHz		±20		ps	
ADJUSTABLE OUTPUT SWING RANGE	Data input = 28 Gbps NRZ PRBS 23 ¹ – 1 pattern, 0.5 V p-p	1.2		2.2	V p-p	
TIMING	Data input = 28 Gbps NRZ PRBS 23 ¹ – 1 pattern, 0.5 V p-p	Rise		15	ps	
		Fall		16	ps	
JITTER	Data input = 28 Gbps NRZ PRBS 23 ¹ – 1 pattern, 0.5 V p-p	Additive RMS Jitter ¹	240	250	310	f _s
		Deterministic			2	ps
SIGNAL-TO-NOISE RATIO (SNR)	Data input = 28 Gbps NRZ PRBS 23 ¹ – 1 pattern, 0.5 V p-p		22		dB	
SUPPLY CURRENT (I_{DD})		50	70	80	mA	
BIAS CURRENT ADJUST/CROSSPOINT ADJUST	Gate Bias Voltage (V_{GG})	Gate Bias Current (I_{GG})	-1.5	-0.85	-0.5	V
					1	mA
OUTPUT AMPLITUDE ADJUST	Control Bias Voltage (V_{CTL})	Control Bias Current (I_{CTL})	-1	0	+0.5	V
					1	mA
CROSSPOINT RANGE ²		45	50	55	%	
PEAK DETECT SENSITIVITY	$R_{LOAD} = 10\text{ M}\Omega$ at VDET and VDETREF	75	85	95	mV/V	

¹ Additive rms jitter is calculated by $J_{RMS\ DUT} = \sqrt{(J_{TESTED})^2 - (J_{SOURCE})^2}$ with 28 Gbps 10101 ... pattern, 0.5 V p-p.

² Adjust V_{GG} between -1 V and 0 V to achieve the desired crosspoint percentage.

TYPICAL BIAS VOLTAGES

Input data amplitude = 500 mV p-p.

Table 3.

Parameter	V_{CTL}	V_{GG}	I_{DD}
V_{DD}			
3.5 V	-0.4 V	-0.9 V	45 mA
4.0 V	-0.4 V	-0.85 V	53 mA
5.0 V	0 V	-0.85 V	70 mA
6.0 V	-0.2 V	-0.8 V	76 mA
7.0 V	-0.2 V	-0.8 V	92 mA
	-0.2 V	Set to get I_{DD}	120 mA ¹

¹ This value denotes the worst case operating conditions with a maximum case temperature of 87°C.

ABSOLUTE MAXIMUM RATINGS

Table 4.

Parameter	Rating
Drain Bias Voltage (V_{DD}) Range	12 V
Gate Bias Voltage (V_{GG})	
Minimum	-1.5 V
Maximum	0 V
Control Bias Voltage (V_{CTL})	
Minimum	-1.5 V
Maximum	2.0 V
Maximum Detector Bias Voltage ($V_{DETBias}$)	2.5 V
Input Voltage Swing (V_{IN})	2 V p-p
Storage Temperature Range	-65°C to +150°C
Operating Temperature Range	-40°C to +87°C
Maximum Peak Reflow Temperature	260°C
Channel Temperature	137°C
Thermal Resistance (Channel to Ground Pad)	56.58°C/W
ESD Sensitivity (Human Body Model)	Class 1A

Stresses at or above those listed under Absolute Maximum Ratings may cause permanent damage to the product. This is a stress rating only; functional operation of the product at these or any other conditions above those indicated in the operational section of this specification is not implied. Operation beyond the maximum operating conditions for extended periods may affect product reliability.

ESD CAUTION



ESD (electrostatic discharge) sensitive device. Charged devices and circuit boards can discharge without detection. Although this product features patented or proprietary protection circuitry, damage may occur on devices subjected to high energy ESD. Therefore, proper ESD precautions should be taken to avoid performance degradation or loss of functionality.

PIN CONFIGURATION AND FUNCTION DESCRIPTIONS

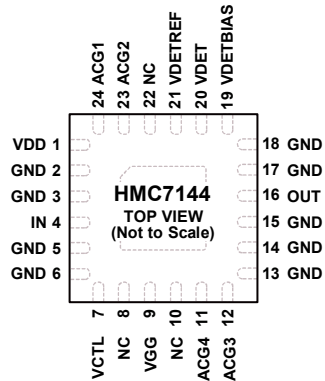

- NOTES
1. NC = NO CONNECT. NO CONNECTION IS REQUIRED FOR THESE PINS.
 2. EXPOSED PAD. THE EXPOSED PAD MUST BE CONNECTED TO RF/DC GROUND.

1831-002

Figure 2. Pin Configuration

Table 5. Pin Function Descriptions

Pin No.	Mnemonic	Description
1	VDD	Supply Voltage.
2, 3, 5, 6, 13 to 15, 17, 18	GND	Ground. These pins and the die bottom must be connected to RF/dc ground. See Figure 3 for the GND interface schematic.
4	IN	Input. Pin 4 is dc-coupled and matched to 50 Ω (see Figure 6).
7	VCTL	Gate Control Voltage. This pin controls the output voltage swing of the amplifier. The typical value for VCTL is -0.2 V. See Figure 5.
8, 10, 22	NC	No Connect. No connection is required for these pins.
9	VGG	Gate Control Voltage, Current.
11	ACG4	Low Frequency Termination. Attach bypass capacitors per the application circuit shown in Figure 5.
12	ACG4	Low Frequency Termination. Attach bypass capacitors per the application circuit shown in Figure 5.
16	OUT	Output. Pin 16 is decoupled and matched to 50 Ω (see Figure 7). The data polarity of the OUT pin is the inverse of the data polarity on the IN pin.
19	VDETBIAS	Detector Bias Voltage. Set Pin 19 to 1.2 V (see Figure 7).
20	VDET	Detector Output Voltage.
21	VDETREF	Detector Reference Voltage (see Figure 7).
23	ACG2	Low Frequency Termination. Attach bypass capacitors per the application circuit shown in Figure 4.
24	ACG1	Low Frequency Termination. Attach bypass capacitors per the application circuit shown in Figure 4.
	EPAD	Exposed Pad. The exposed pad must be connected to RF/dc ground.

INTERFACE SCHEMATICS



Figure 3. GND Interface Schematic

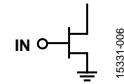

Figure 6. IN Interface Schematic

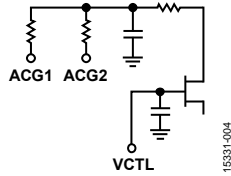

Figure 4. ACG1, ACG2, and VCTL Interface Schematic

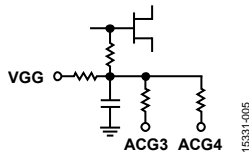

Figure 5. ACG3, ACG4, and VGG Interface Schematic

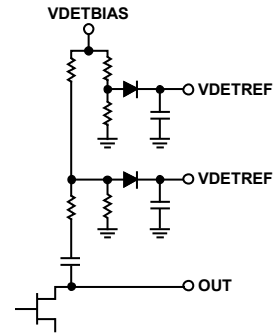

Figure 7. VDETBIAS, VDETREF, and OUT Interface Schematic

TYPICAL PERFORMANCE CHARACTERISTICS

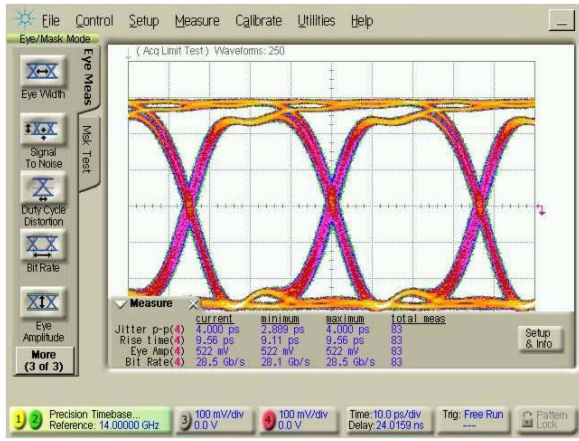

Figure 8. 28 Gbps NRZ PRBS 2³¹ - 1 Pattern Input Data, Input Eye Diagram, V_{IN} = 510 mV p-p

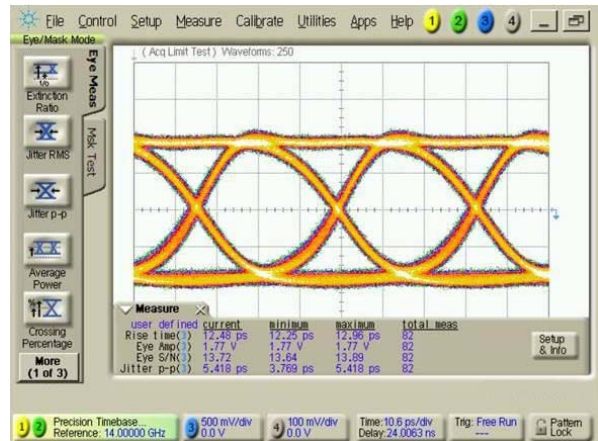

Figure 11. 28 Gbps Output Eye Diagram at V_{DD} = 4.0 V, V_{CTL} = -0.2 V, V_{GG} = -0.89 V, I_{DD} = 50 mA, V_{OUT} = 1.77 V p-p, P_{DISS} = 0.20 W

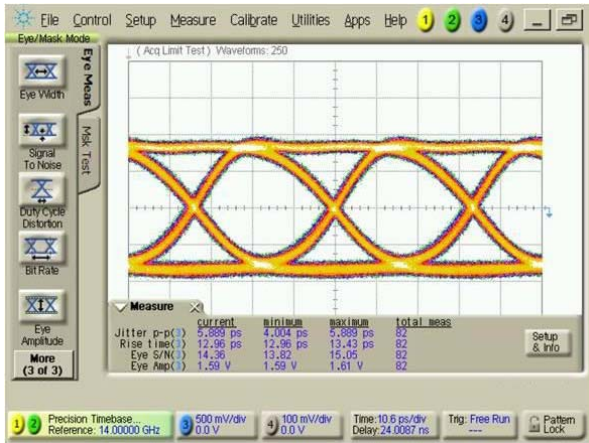

Figure 9. 28 Gbps Output Eye Diagram at V_{DD} = 3.5 V, V_{CTL} = -0.3 V, V_{GG} = -0.9 V, I_{DD} = 44 mA, V_{OUT} = 1.59 V p-p, P_{DISS} = 0.15 W

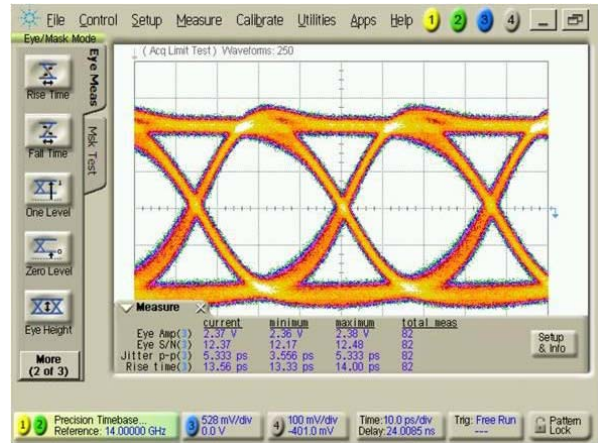

Figure 12. 28 Gbps Output Eye Diagram at V_{DD} = 6.0 V, V_{CTL} = -0.03 V, V_{GG} = -0.81 V, I_{DD} = 79 mA, V_{OUT} = 2.37 V p-p, P_{DISS} = 0.47 W

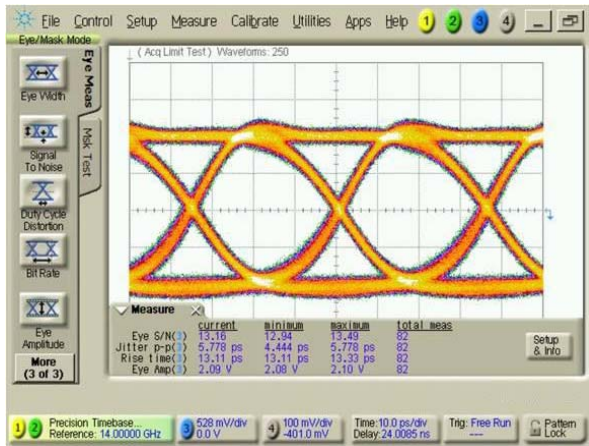

Figure 10. 28 Gbps Output Eye Diagram at V_{DD} = 5.0 V, V_{CTL} = -0.05 V, V_{GG} = -0.85 V, I_{DD} = 64 mA, V_{OUT} = 2.09 V p-p, P_{DISS} = 0.32 W

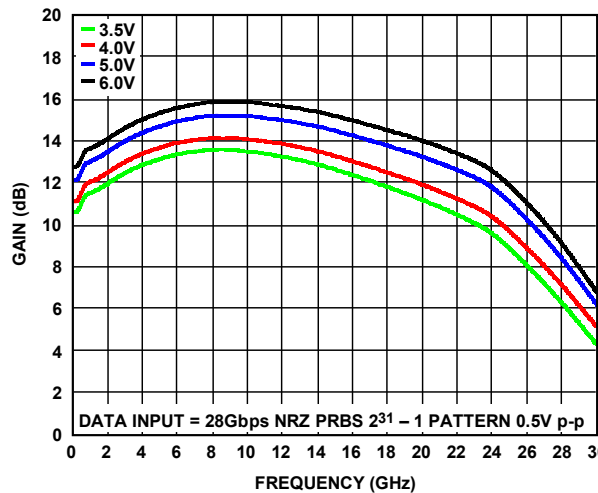

Figure 13. Gain over Supply, V_{GG} = -0.90 V

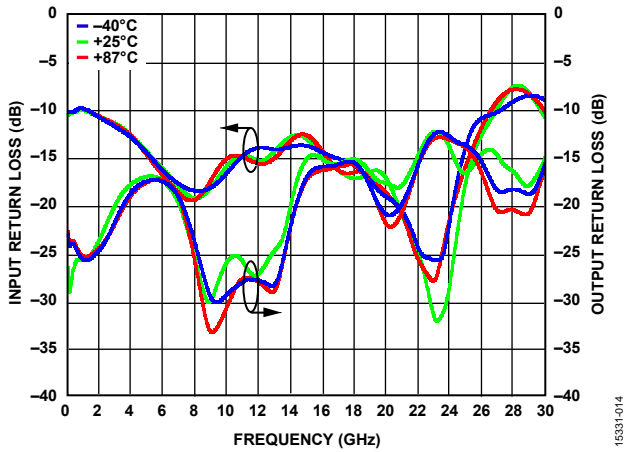

Figure 14. Input and Output Return Loss over Temperature, $V_{DD} = 5 V$ (See Table 3 for Typical Bias Voltages)

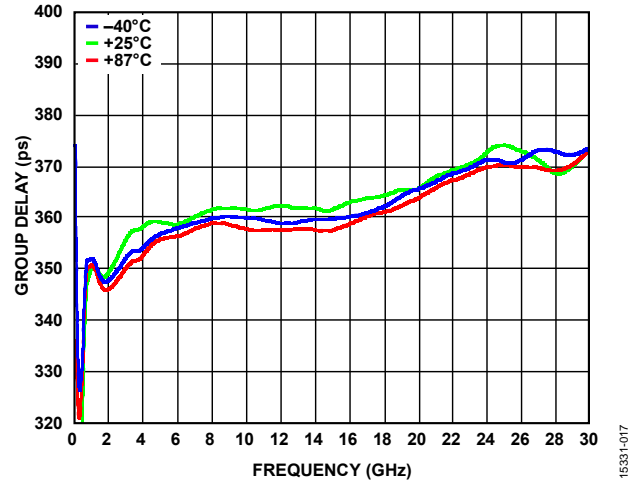

Figure 17. Group Delay vs. Frequency over Temperature, $V_{GG} = -0.90 V$, $V_{DD} = 5 V$ (See Table 3 for Typical Bias Voltages)

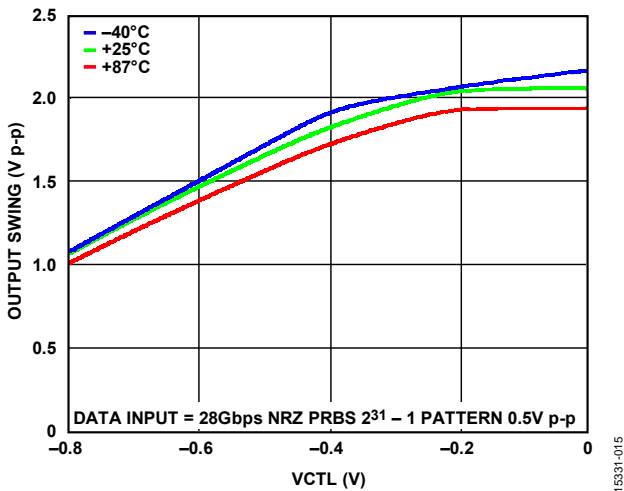

Figure 15. Output Swing vs. VCTL over Temperature, $V_{GG} = -0.90 V$, Data Input = 28 Gbps NRZ PRBS 231 - 1 Pattern, 0.5 V p-p, $V_{DD} = 5 V$ (See Table 3 for Typical Bias Voltages)

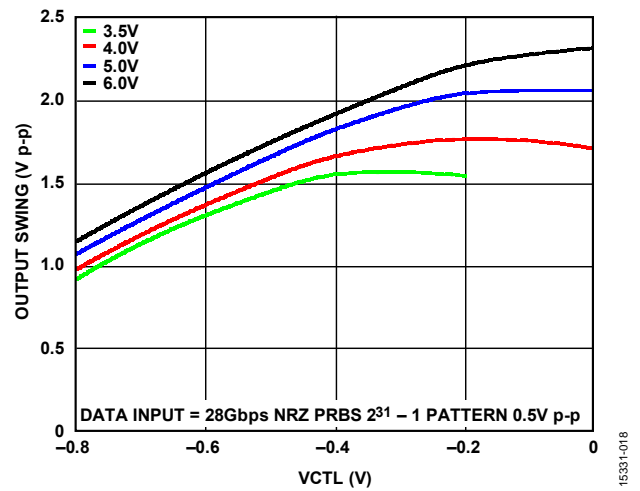

Figure 18. Output Swing vs. VCTL over Supply, $V_{GG} = -0.90 V$, Data Input = 28 Gbps NRZ PRBS 231 - 1 Pattern, 0.5 V p-p

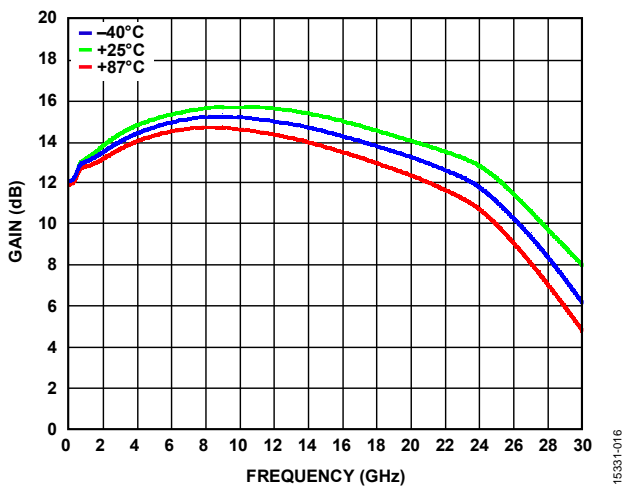

Figure 16. Gain over Temperature, $V_{DD} = 5 V$ (See Table 3 for Typical Bias Voltages)

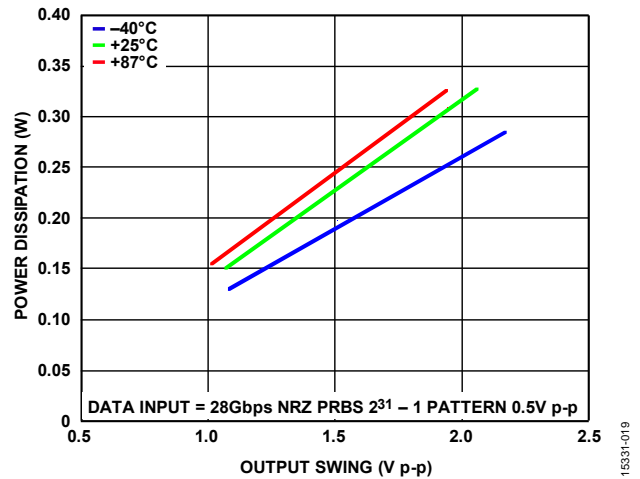

Figure 19. Power Dissipation vs. Output Swing over Temperature, $V_{DD} = 5 V$ (See Table 3 for Typical Bias Voltages), Data Input = 28 Gbps NRZ PRBS 231 - 1 Pattern, 0.5 V p-p

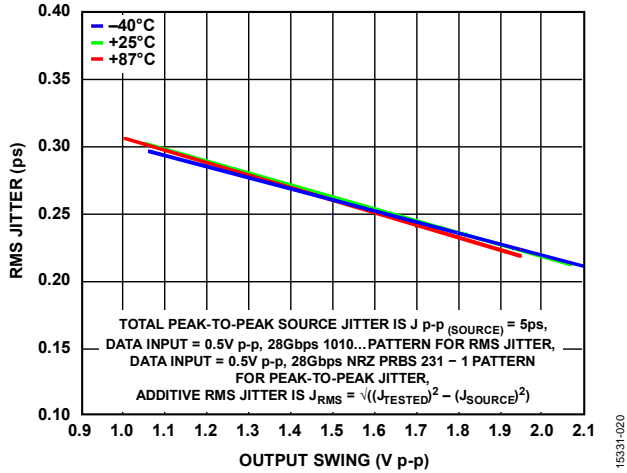

Figure 20. RMS Jitter vs. Output Swing over Temperature, $V_{DD} = 5V$ (See Table 3 for Typical Bias Voltages), Total Peak-to-Peak Source Jitter is $J_{p-p(SOURCE)} = 5ps$, Data Input = 0.5 V p-p, 28 Gbps 1010 ... Pattern for RMS Jitter, Data Input = 0.5 V p-p, 28 Gbps NRZ PRBS $2^{31} - 1$ Pattern for Peak-To-Peak Jitter, Additive RMS Jitter is $J_{RMS} = \sqrt{((J_{TESTED})^2 - (J_{SOURCE})^2)}$

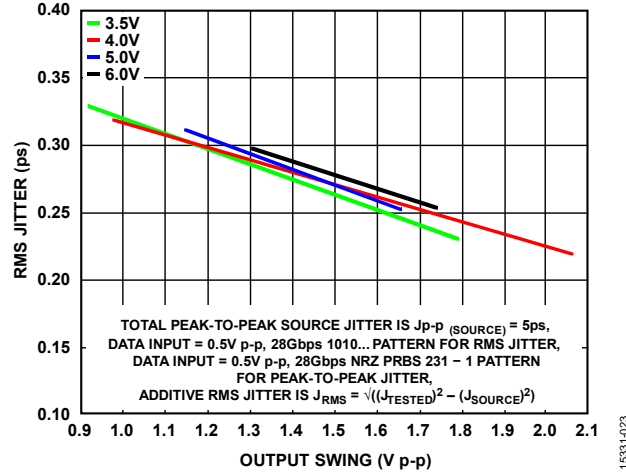

Figure 23. RMS Jitter vs. Output Swing over Supply, $V_{GG} = -0.90V$, Total Peak-to-Peak Source Jitter is $J_{p-p(SOURCE)} = 5ps$, Data Input = 0.5 V p-p, 28 Gbps 1010 ... Pattern for RMS Jitter, Data Input = 0.5 V p-p, 28 Gbps NRZ PRBS $2^{31} - 1$ Pattern for Peak-To-Peak Jitter, Additive RMS Jitter is $J_{RMS} = \sqrt{((J_{TESTED})^2 - (J_{SOURCE})^2)}$

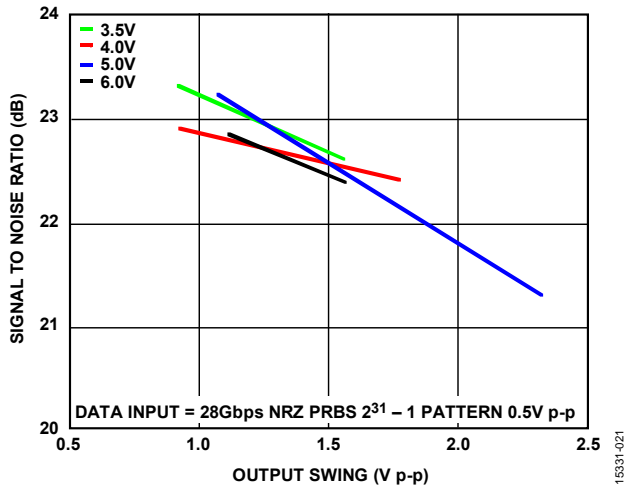

Figure 21. Signal-to-Noise Ratio vs. Output Swing over Supply, $V_{GG} = -0.90V$, Data Input = 28 Gbps NRZ PRBS $2^{31} - 1$ Pattern, 0.5 V p-p

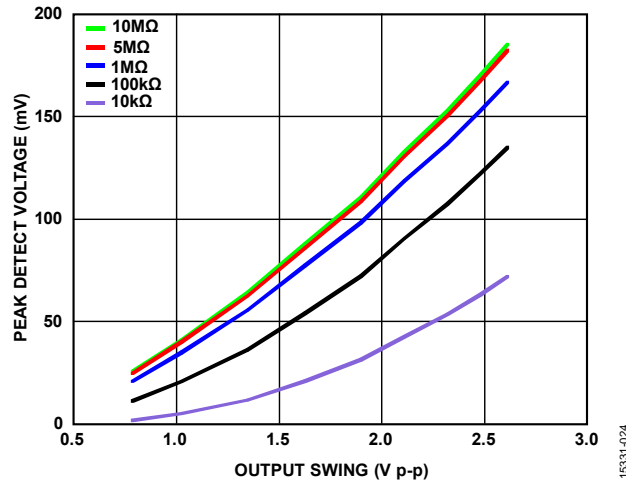

Figure 24. Peak-Detect Voltage vs. Output Swing over R_{LOAD} , $V_{DD} = 5V$ (See Table 3 for Typical Bias Voltages), $V_{DETBIAS} = 1.2V$, Peak Detect Voltage = $V_{DET} - V_{DETREF}$, R_{LOAD} is Equivalent Resistance to GND at V_{DET} and V_{DETREF} Pins

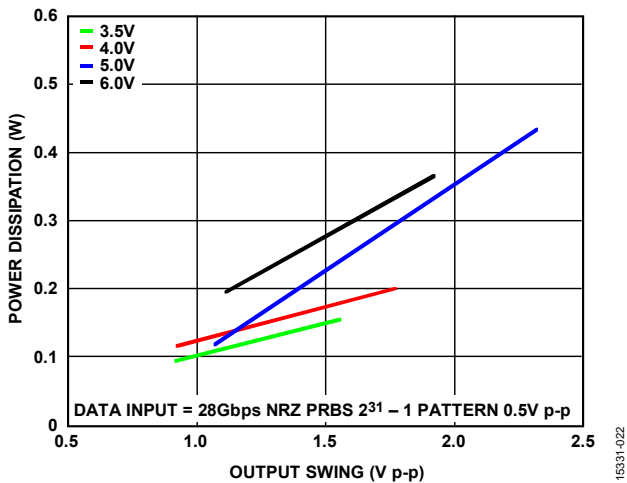

Figure 22. Power Dissipation vs. Output Swing over Supply, $V_{GG} = -0.90V$, Data Input = 28 Gbps NRZ PRBS $2^{31} - 1$ Pattern, 0.5 V p-p

EVALUATION PRINTED CIRCUIT BOARD (PCB)

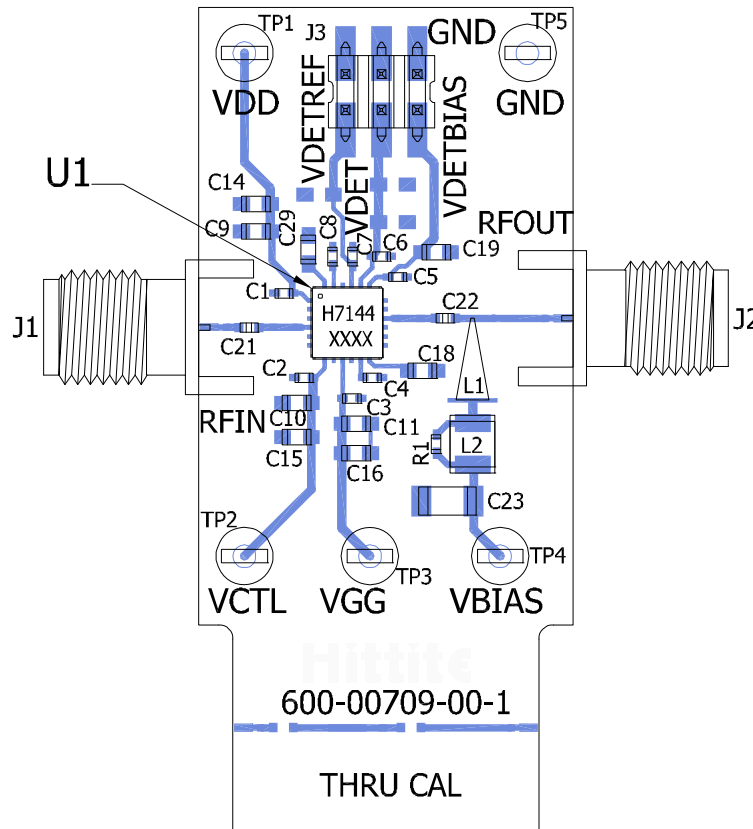

Figure 26. EVAL01-HMC7144LC4 Evaluation PCB

Table 6. Bill of Materials for the EVAL01-HMC7144LC4 Evaluation Board¹

Item	Description
J1, J2	K connector
J3	2 mm, 6-pin SMT header
TP1 to TP5	DC test point
C1 to C8	1000 pF capacitor, 0402 package
C9 to C11	10 nF capacitor, 0603 package
C14 to C16	4.7 μF capacitor, 0603 package
C18 to C19, C29	0.47 μF capacitor, 0603 package
C21, C22	47,000 pF capacitor, 0402 package
C23	10 μF capacitor, 1206 package
L1	0.53 μH inductor, conical package
L2	100 μH inductor, 1210 package
U1	HMC7144, 28 Gbps, EML driver with peak detector
PCB	600-00709-00-1 evaluation board, circuit board material is Rogers 4350 or Arlon 25 FR

¹ Reference this number to order the full evaluation PCB.

The board in this application uses radio frequency (RF) circuit board design techniques. Provide 50 Ω impedance for the signal lines and connect the package ground leads and exposed pad directly to the ground plane, similar to that shown in Figure 26. Use a sufficient number of via holes to connect the top and bottom ground planes.

OUTLINE DIMENSIONS

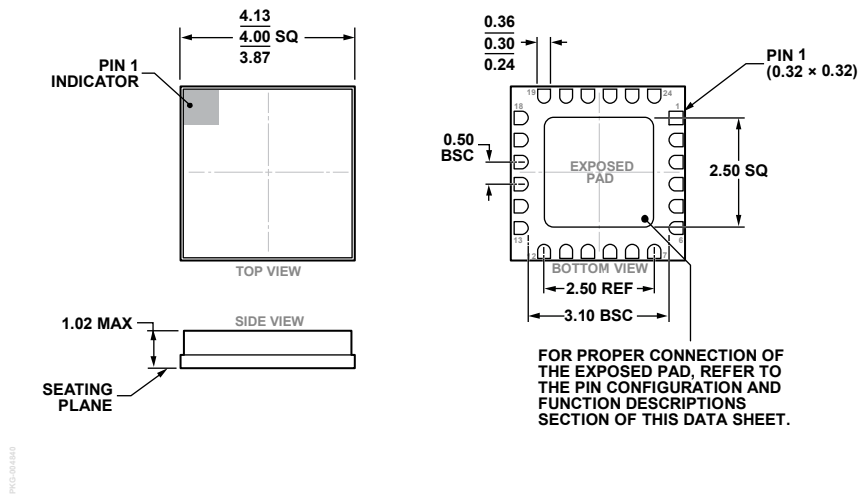

Figure 27. 24-Terminal Ceramic Leadless Chip Carrier [LCC] (E-24-1)
Dimensions shown in millimeters

ORDERING GUIDE

Model	Temperature Range	MSL Rating ¹	Package Description ²	Package Option	Branding ³
HMC7144LC4	-40°C to +87°C	MSL3	24-Terminal Ceramic Leadless Chip Carrier Package [LCC], 50 Pieces Reel	E-24-1	H7144 XXXX
HMC7144LC4TR	-40°C to +87°C	MSL3	24-Terminal Ceramic Leadless Chip Carrier Package [LCC], 100 Pieces Reel	E-24-1	H7144 XXXX
HMC7144LC4TR-R5	-40°C to +87°C	MSL3	24-Terminal Ceramic Leadless Chip Carrier Package [LCC], 500 Pieces Reel	E-24-1	H7144 XXXX
EVAL01-HMC7144LC4			Evaluation Board		

¹ See the Absolute Maximum Ratings section.
² Package body material is alumina, white. Lead finish is gold over nickel.
³ XXXX is the 4-digit lot number.

X-ON Electronics

Largest Supplier of Electrical and Electronic Components

Click to view similar products for [Laser Drivers](#) category:

Click to view products by [Analog Devices](#) manufacturer:

Other Similar products are found below :

[AXXSATADVDRWROM937575 937575](#) [ADN2872ACPZ](#) [AD9665ACPZ-REEL7](#) [ADN2830ACPZ32](#) [ADN2841ACPZ-48](#) [ADN2847ACPZ-32](#) [ADN2871ACPZ](#) [ADN2841ACPZ-32](#) [HMC7144LC4](#) [HMC7144LC4TR](#) [HMC7150LP3DE](#) [HMC7810ALC3](#) [DS1873T+](#) [DS1874T+](#) [MAX3946ETG+T](#) [MAX3740AETG+T](#) [MAX3735AETG+T](#) [MAX3643ETG+T](#) [MAX3646ETG+](#) [MAX3656ETG+](#) [MAX3740AETG+](#) [MAX3949ETE+](#) [MAX3949ETE+T](#) [MAX3736ETE+T](#) [MAX3869ETJ](#) [MAX3798ETJ+](#) [MAX3737ETJ+](#) [DS1863E](#) [SY88422LMG](#) [MAX3669EHJ](#) [SY88992LMG-TR](#) [SY84782UMG](#) [SY88022ALMG](#) [SY88992LMG](#) [SY88236LMG](#) [SY88432LMG-TR](#) [SY88432LMG](#) [ONET1151LRGET](#) [ONET1151PRGTT](#) [ONET4201LDRGER](#) [ONET4201LDRGET](#) [ONET4211LDRGET](#) [ONET1101LRGER](#) [ONET1151LRGER](#) [ONET8501VRGPT](#) [MAX3948ETE](#) [MAX3946ETG+](#) [MAX3996CTP+](#) [MAX24002TL+](#) [DS1864T+](#)