

## MMIC VCO w/ HALF FREQUENCY OUTPUT 14.9 - 15.5 GHz



### Typical Applications

The HMC737LP4(E) is ideal for:

- Point to Point/Multipoint Radio
- Test Equipment & Industrial Controls
- SATCOM
- Military End-Use

### Features

- Dual Output:  $F_o = 14.9 - 15.5$  GHz  
 $F_o/2 = 7.45 - 7.75$  GHz
- Pout: +9 dBm
- Phase Noise: -105 dBc/Hz @ 100 kHz
- No External Resonator Needed
- 24 Lead 4x4mm SMT Package: 16mm<sup>2</sup>

### Functional Diagram

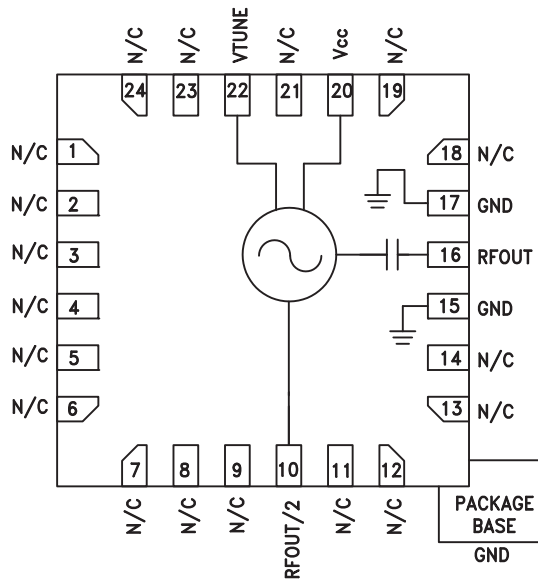

### General Description

The HMC737LP4(E) is a GaAs InGaP Heterojunction Bipolar Transistor (HBT) MMIC VCO. The HMC737LP4(E) integrate a resonator, negative resistance device, varactor diode and feature half frequency output. The VCO's phase noise performance is excellent over temperature, shock, and process due to the oscillator's monolithic structure. Power output is +9 dBm typical from a +4.2V supply voltage. The voltage controlled oscillator is packaged in a leadless QFN 4x4 mm surface mount package, and requires no external matching components.

### Electrical Specifications, $T_A = +25^\circ C$ , $V_{cc} = +4.2V$

| Parameter  | Min.             | Typ.                       | Max.       | Units      |                 |
|--|------------------|----------------------------|------------|------------|-----------------|
| Frequency Range  | $F_o$<br>$F_o/2$ | 14.9 - 15.5<br>7.45 - 7.75 |            | GHz<br>GHz |                 |
| Power Output   | RFOUT<br>RFOUT/2 | 6<br>-8                    | 9<br>-3    | 13<br>2    | dBm<br>dBm      |
| SSB Phase Noise @ 100 kHz Offset, $V_{tune} = +5V$ @ RFOUT |                  | -105                       |            |            | dBc/Hz          |
| Tune Voltage   | $V_{tune}$       | 1                          |            | 13         | V               |
| Supply Current   |                  | 120                        | 150        | 180        | mA              |
| Tune Port Leakage Current ( $V_{tune} = 13V$ )             |                  |                            | 10         |            | $\mu A$         |
| Output Return Loss   |                  | 2.5                        |            |            | dB              |
| Harmonics/Subharmonics                                     | 1/2<br>3/2       |                            | -45<br>-42 |            | dBc<br>dBc      |
| Pulling (into a 2.0:1 VSWR)                                |                  |                            | 12         |            | MHz pp          |
| Pushing @ $V_{tune} = 5V$                                  |                  |                            | 24         |            | MHz/V           |
| Frequency Drift Rate                                       |                  |                            | 1.2        |            | MHz/ $^\circ C$ |

Information furnished by Analog Devices is believed to be accurate and reliable. However, no responsibility is assumed by Analog Devices for its use, nor for any infringements of patents or other rights of third parties that may result from its use. Specifications subject to change without notice. No license is granted by implication or otherwise under any patent or patent rights of Analog Devices. Trademarks and registered trademarks are the property of their respective owners.

For price, delivery, and to place orders: Analog Devices, Inc., One Technology Way, P.O. Box 9106, Norwood, MA 02062-9106 Phone: 781-329-4700 • Order online at [www.analog.com](http://www.analog.com) Application Support: Phone: 1-800-ANALOG-D



**MMIC VCO w/ HALF FREQUENCY OUTPUT  
14.9 - 15.5 GHz**

**Frequency vs. Tuning Voltage, Vcc = +4.2V**

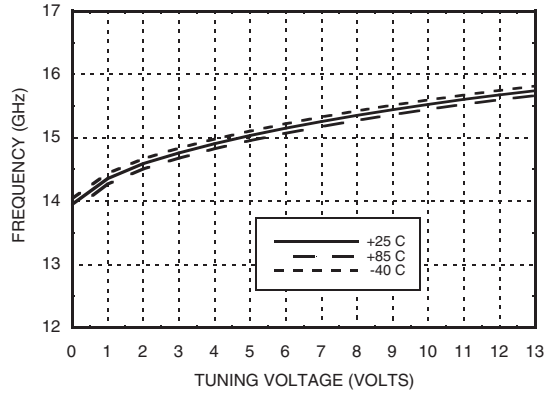

**Frequency vs. Tuning Voltage, T = 25°C**

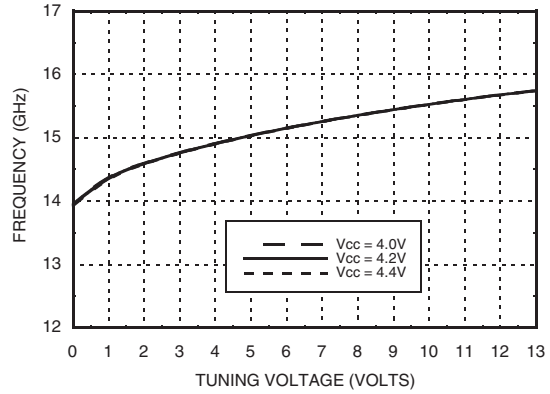

**Sensitivity vs. Tuning Voltage, Vcc = +4.2V**

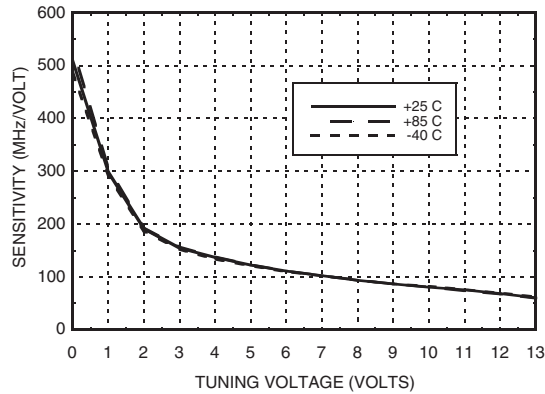

**Output Power vs. Tuning Voltage, Vcc = +4.2V**

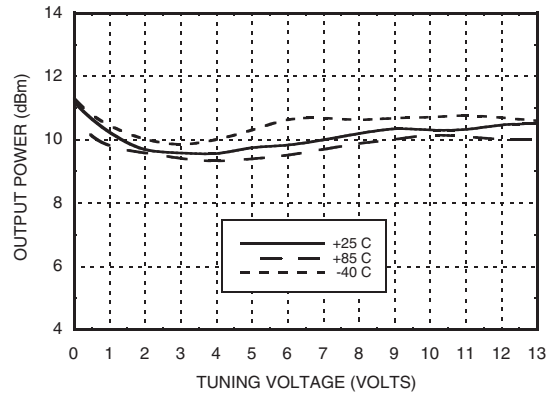

**SSB Phase Noise vs. Tuning Voltage**

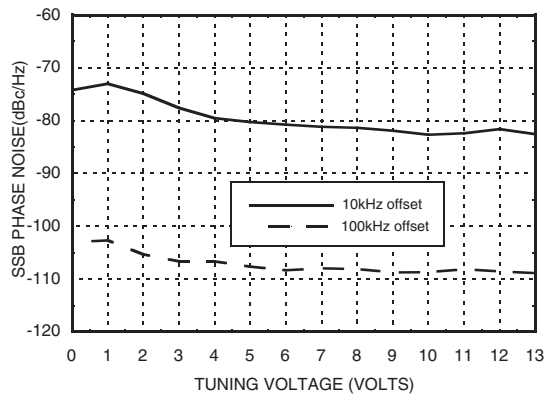

**SSB Phase Noise @ Vtune = +5V**

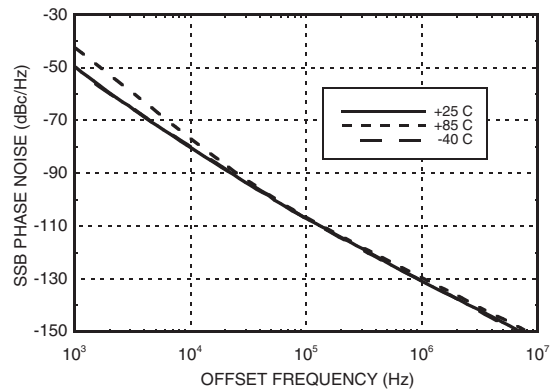

Information furnished by Analog Devices is believed to be accurate and reliable. However, no responsibility is assumed by Analog Devices for its use, nor for any infringements of patents or other rights of third parties that may result from its use. Specifications subject to change without notice. No license is granted by implication or otherwise under any patent or patent rights of Analog Devices. Trademarks and registered trademarks are the property of their respective owners.

For price, delivery, and to place orders: Analog Devices, Inc., One Technology Way, P.O. Box 9106, Norwood, MA 02062-9106 Phone: 781-329-4700 • Order online at [www.analog.com](http://www.analog.com) Application Support: Phone: 1-800-ANALOG-D

## MMIC VCO w/ HALF FREQUENCY OUTPUT 14.9 - 15.5 GHz



**RFOUT/2 Frequency vs. Tuning Voltage, Vcc = +4.2V**

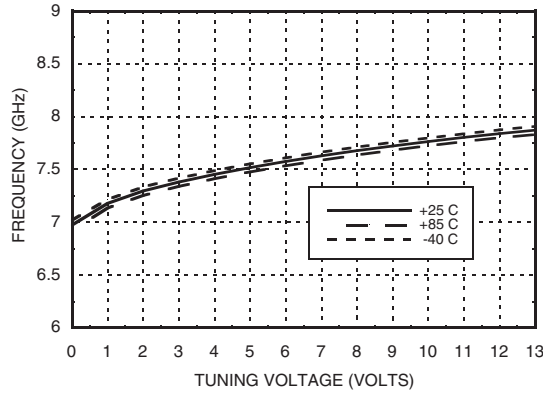

**RFOUT/2 Output Power vs. Tuning Voltage, Vcc = +4.2V**

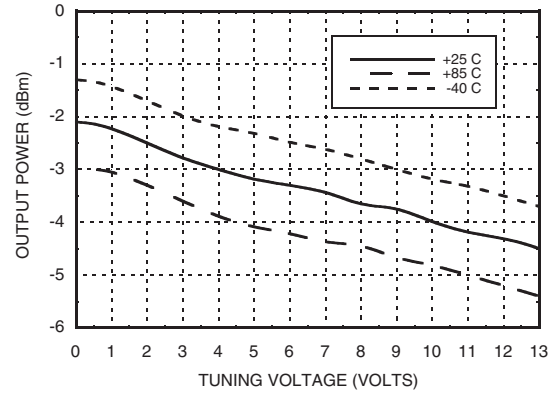

### Absolute Maximum Ratings

|  |                |
|--|----------------|
| Vcc  | +5.5V          |
| Vtune  | 0 to 15V       |
| Junction Temperature   | 135 °C         |
| Continuous Pdiss (T=85 °C)<br>(derate 19.6 mW/C above 85 °C) | 1 W            |
| Thermal Resistance<br>(junction to ground paddle)            | 51 °C/W        |
| Storage Temperature  | -65 to +150 °C |
| Operating Temperature  | -40 to +85 °C  |

### Typical Supply Current vs. Vcc

| Vcc (V) | Icc (mA) |
|---------|----------|
| 4.0     | 140      |
| 4.2     | 150      |
| 4.4     | 160      |

Note: VCO will operate over full voltage range shown above.



**ELECTROSTATIC SENSITIVE DEVICE  
OBSERVE HANDLING PRECAUTIONS**

### Package Information

| Part Number | Package Body Material                              | Lead Finish   | MSL Rating          | Package Marking <sup>[3]</sup> |
|-------------|--|---------------|---------------------|--------------------------------|
| HMC737LP4   | Low Stress Injection Molded Plastic                | Sn/Pb Solder  | MSL1 <sup>[1]</sup> | H737<br>XXXX                   |
| HMC737LP4E  | RoHS-compliant Low Stress Injection Molded Plastic | 100% matte Sn | MSL1 <sup>[2]</sup> | H737<br>XXXX                   |

[1] Max peak reflow temperature of 235 °C

[2] Max peak reflow temperature of 260 °C

[3] 4-Digit lot number XXXX



**MMIC VCO w/ HALF FREQUENCY OUTPUT**  
**14.9 - 15.5 GHz**

**Outline Drawing**

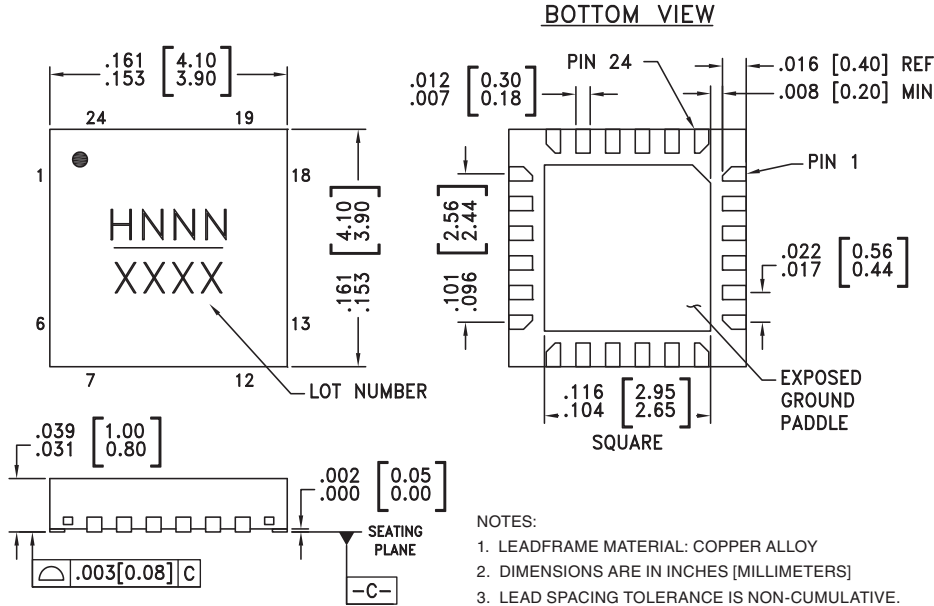

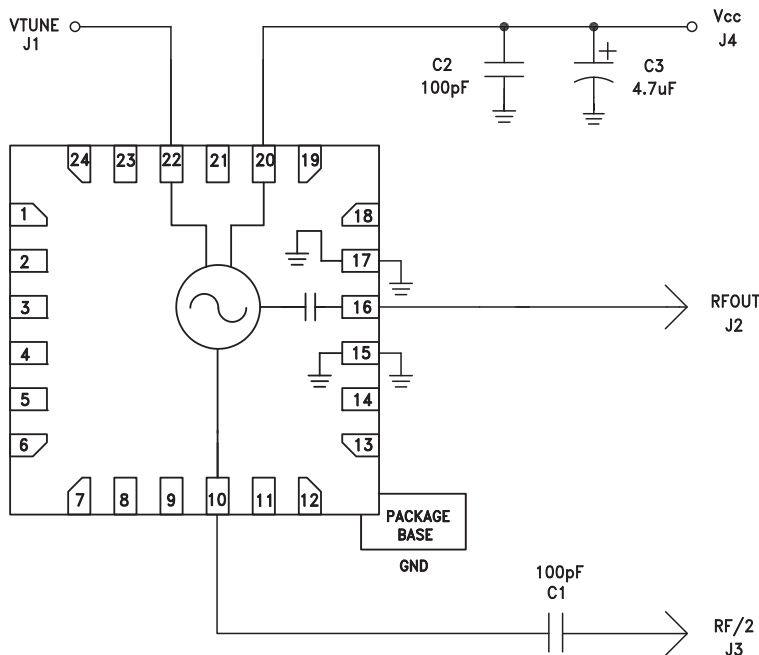

**Application Circuit**



Information furnished by Analog Devices is believed to be accurate and reliable. However, no responsibility is assumed by Analog Devices for its use, nor for any infringements of patents or other rights of third parties that may result from its use. Specifications subject to change without notice. No license is granted by implication or otherwise under any patent or patent rights of Analog Devices. Trademarks and registered trademarks are the property of their respective owners.

For price, delivery, and to place orders: Analog Devices, Inc., One Technology Way, P.O. Box 9106, Norwood, MA 02062-9106 Phone: 781-329-4700 • Order online at [www.analog.com](http://www.analog.com) Application Support: Phone: 1-800-ANALOG-D

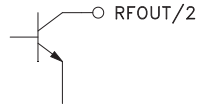
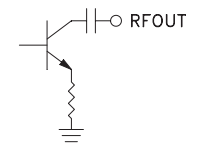
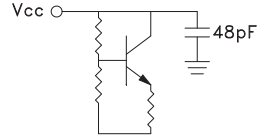
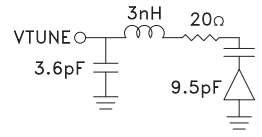
**MMIC VCO w/ HALF FREQUENCY OUTPUT  
14.9 - 15.5 GHz**
**Pin Descriptions**

| Pin Number                         | Function | Description   | Interface Schematic   |
|------------------------------------|----------|---|---|
| 1 - 9, 11 - 14, 18, 19, 21, 23, 24 | N/C      | No Connection. These pins may be connected to RF/DC ground. Performance will not be affected.   |   |
| 10                                 | RFOUT/2  | Half frequency output (AC coupled). Requires external AC coupling capacitors.   |    |
| 16                                 | RFOUT    | RF output (AC coupled).   |    |
| 20                                 | Vcc      | Supply Voltage, +4.2V   |    |
| 22                                 | VTUNE    | Control voltage and modulation input. Modulation bandwidth dependent on drive source impedance. See "Determining the FM Bandwidth of a Wideband Varactor Tuned VCO" application note. |   |
| 15, 17, Paddle                     | GND      | Package bottom has an exposed metal paddle that must be connected to RF/DC ground.  |  |

**MMIC VCO w/ HALF FREQUENCY OUTPUT  
14.9 - 15.5 GHz**

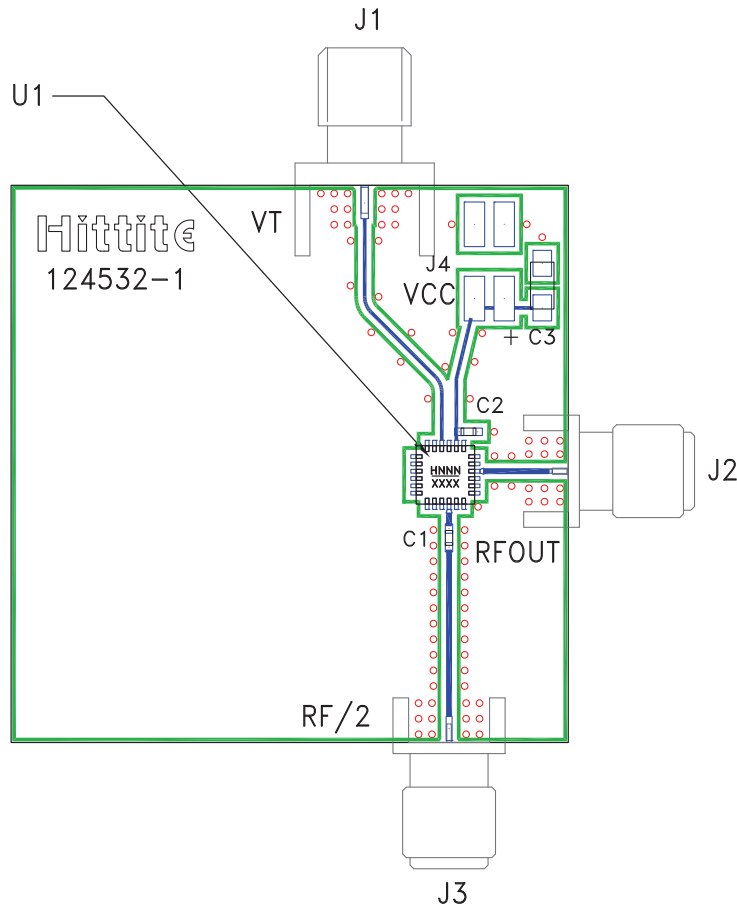
**Evaluation PCB**

**List of Materials for Evaluation PCB 123987 [1]**

| Item    | Description                 |
|---------|-----------------------------|
| J1 - J3 | PCB Mount SMA RF Connector  |
| J4      | 2 mm DC Header              |
| C1, C2  | 100 pF Capacitor, 0402 Pkg. |
| C3      | 4.7 µF Tantalum Capacitor   |
| U1      | HMC737LP4(E) VCO            |
| PCB [2] | 124532 Eval Board           |

[1] Reference this number when ordering complete evaluation PCB

[2] Circuit Board Material: Rogers 4350 or Arlon 25FR

The circuit board used in the application should use RF circuit design techniques. Signal lines should have 50 Ohm impedance while the package ground leads and backside ground paddle should be connected directly to the ground plane similar to that shown. A sufficient number of via holes should be used to connect the top and bottom ground planes. The evaluation circuit board shown is available from Hittite upon request.

## X-ON Electronics

Largest Supplier of Electrical and Electronic Components

*Click to view similar products for [VCO Oscillators](#) category:*

*Click to view products by [Analog Devices](#) manufacturer:*

Other Similar products are found below :

[MAOC-009260-SMB003](#) [MAOC-009261-PKG003](#) [MAOC-009872-000000](#) [MAOC-009264-PKG003](#) [HMC384LP4ETR](#) [CVCO33CL-0110-0150](#) [CVCO33CL-0415-0435](#) [CVCO33CL-0750-0770](#) [HMC1166LP5ETR](#) [HMC391LP4TR](#) [HMC1168LP5ETR](#) [MAOC-009260-PKG003](#) [MAOC-009266-PKG003](#) [HMC511LP5ETR](#) [HMC534LP5ETR](#) [HMC431LP4ETR](#) [HMC3587LP3BETR](#) [CVC055CC-1680-1680](#) [CVCO33CL-0125-0200](#) [CVCO45CL-0100-0140](#) [CVCO45CL-0421-0441](#) [CRBV55BE-1930-1990](#) [MAX2609EUT+T](#) [HMC1160LP5E](#) [HMC1164LP5E](#) [HMC1166LP5E](#) [HMC1167LP5E](#) [HMC1168LP5E](#) [HMC587LC4BTR](#) [HMC732LC4B](#) [HMC358MS8GE](#) [HMC384LP4E](#) [HMC385LP4E](#) [HMC388LP4E](#) [HMC390LP4E](#) [HMC391LP4](#) [HMC391LP4E](#) [HMC398QS16GE](#) [HMC401QS16GE](#) [HMC416LP4E](#) [HMC429LP4E](#) [HMC430LP4E](#) [HMC466LP4E](#) [HMC506LP4](#) [HMC507LP5E](#) [HMC508LP5E](#) [HMC509LP5](#) [HMC510LP5E](#) [HMC511LP5E](#) [HMC512LP5E](#)