

### FEATURES

- Conversion loss: 9 dB typical
- Local oscillator (LO) to radio frequency (RF) isolation:  
37 dB typical
- LO to intermediate frequency (IF) isolation: 37 dB typical
- RF to IF isolation: 20 dB typical
- Input third-order intercept (IP3): 20 dBm typical
- Input second-order intercept (IP2): 50 dBm typical
- Input power for 1 dB compression (P1dB): 10 dBm typical
- IF bandwidth: dc to 8 GHz
- Passive: no dc bias required
- 3 mm × 3 mm, 12-terminal ceramic LCC package

### APPLICATIONS

- Point to point radios
- Point to multipoint radios and very small aperture terminals (VSATs)
- Test equipment and sensors
- Military end use

### GENERAL DESCRIPTION

The [HMC773ALC3B](#) is a general-purpose, double balanced mixer in a leadless, RoHS compliant LCC package that can be used as an upconverter or downconverter from 6 GHz to 26 GHz. This mixer requires no external components or matching circuitry.

### FUNCTIONAL BLOCK DIAGRAM

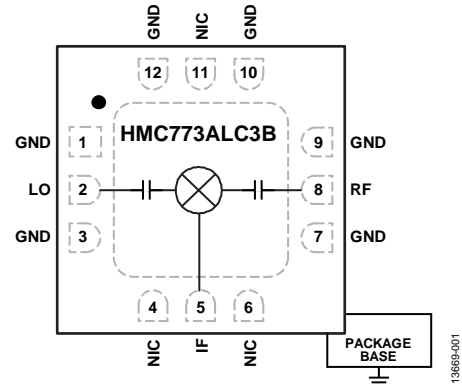

Figure 1.

The [HMC773ALC3B](#) provides excellent LO to RF and LO to IF suppression due to optimized balun structures. The mixer operates well with LO drive levels of 13 dBm or above. The [HMC773ALC3B](#) eliminates the need for wire bonding, allowing use of surface-mount manufacturing techniques.

## TABLE OF CONTENTS

Features .....	1	Downconverter, Upper Sideband, IF = 7000 MHz.....	10
Applications.....	1	Downconverter, Lower Sideband, IF = 500 MHz.....	11
Functional Block Diagram .....	1	Downconverter, Lower Sideband, IF = 1000 MHz.....	12
General Description .....	1	Downconverter, Lower Sideband, IF = 3000 MHz.....	13
Revision History .....	2	Downconverter, Lower Sideband, IF = 7000 MHz.....	14
Specifications.....	3	Downconverter, P1dB Performance .....	15
Electrical Specifications.....	3	Upconverter, Upper Sideband .....	16
Absolute Maximum Ratings.....	4	Upconverter, Lower Sideband .....	17
Thermal Resistance .....	4	Noise Figure Performance.....	18
ESD Caution.....	4	Spurious Performance .....	19
Pin Configuration and Function Descriptions.....	5	Theory of Operation .....	20
Interface Schematics.....	5	Applications Information .....	21
Typical Performance Characteristics .....	6	Typical Application Circuit.....	21
Downconverter, Upper Sideband, IF = 500 MHz.....	6	Evaluation PCB Information .....	21
Downconverter, Upper Sideband, IF = 1000 MHz.....	8	Outline Dimensions.....	22
Downconverter, Upper Sideband, IF = 3000 MHz.....	9	Ordering Guide .....	22

## REVISION HISTORY

### 4/2019—Rev. E to Rev. F

Changes to Table 5, Figure 4, and Figure 6 .....	5
--	---

### 8/2018—Rev. D to Rev. E

Changes to Table 5, Figure 4, and Figure 6 .....	5
Changes to Ordering Guide .....	22

### 9/2017—Rev. C to Rev. D

Changed HMC773A to HMC773ALC3B .....	Throughout
Changes to Ordering Guide.....	22

### 6/2017—Rev. B to Rev. C

Updated Outline Dimensions.....	22
Changes to Ordering Guide.....	22

### 1/2017—Rev. A to Rev. B

Changed HE-12-1 to E-12-1 .....	Throughout
Changes to Features Section, Figure 1, and General Description Section.....	1
Changes to Noise Figure Parameter, Isolation Parameter, and Input Third-Order Intercept Parameter, Table 1; and Conversion Loss Parameter, Noise Figure Parameter, Isolation Parameter, and Input Third-Order Intercept Parameter, Table 2 .....	3
Changes to Table 3.....	4
Added Thermal Resistance Section and Table 4; Renumbered Sequentially .....	4
Changes to Typical Performance Characteristics Section.....	6

Changes to Spurious Performance Section.....	19
Deleted M × N Spurious Outputs Section.....	19
Added M × N Spurious Outputs, IF = 500 MHz Section and M × N Spurious Outputs, IF = 1000 MHz Section.....	19
Changes to Theory of Operation Section.....	20
Changed Application Circuit and Evaluation Printed Circuit Board (PCB) Section to Typical Application Circuit Section...	21
Changes to Typical Application Circuit Section, Figure 77, Evaluation PCB Information Section, and Table 6 .....	21

### 9/2015—v.00.0715 to Rev. A

This Hittite Microwave Products data sheet has been reformatted to meet the styles and standards of Analog Devices, Inc.

Updated Format.....	Universal
Changes to Features .....	1
Changes to Table 3.....	4
Changes to Figure 72.....	17
Changes to Figure 86.....	19
Changes to Spurious Performance Section.....	20
Added Theory of Operation Section .....	21
Added Applications Information Heading .....	22
Changes to Figure 89.....	22
Updated Outline Dimensions.....	23
Changes to Ordering Guide .....	23

## SPECIFICATIONS

### ELECTRICAL SPECIFICATIONS

$T_A = 25^\circ\text{C}$ , IF = 500 MHz, LO drive = 13 dBm, RF frequency range = 6.0 GHz to 16.0 GHz, all measurements performed as a downconverter with the upper sideband selected, unless otherwise noted.

Table 1.

Parameter	Symbol	Min	Typ	Max	Unit
FREQUENCY RANGE					
Radio Frequency	RF	6		16	GHz
Local Oscillator	LO	6		16	GHz
Intermediate Frequency	IF	dc		8	GHz
CONVERSION LOSS			9	12	dB
NOISE FIGURE			10		dB
ISOLATION					
LO to RF		33	37		dB
LO to IF		30	37		dB
RF to IF		11	15		dB
INPUT THIRD-ORDER INTERCEPT	IP3	11	17		dBm
INPUT SECOND-ORDER INTERCEPT	IP2		45		dBm
INPUT POWER					
1 dB Compression	P1dB		10		dBm
RETURN LOSS					
RF Port			12		dB
LO Port			12		dB

$T_A = 25^\circ\text{C}$ , IF = 500 MHz, LO drive = 13 dBm, RF frequency range = 16.0 GHz to 26.0 GHz, all measurements performed as a downconverter with the upper sideband selected, unless otherwise noted.

Table 2.

Parameter	Symbol	Min	Typ	Max	Unit
FREQUENCY RANGE					
Radio Frequency	RF	16		26	GHz
Local Oscillator	LO	16		26	GHz
Intermediate Frequency	IF	dc		8	GHz
CONVERSION LOSS			9	14	dB
NOISE FIGURE			12		dB
ISOLATION					
LO to RF		33	37		dB
LO to IF		32	37		dB
RF to IF		15	20		dB
INPUT THIRD-ORDER INTERCEPT	IP3	16	20		dBm
INPUT SECOND-ORDER INTERCEPT	IP2		50		dBm
INPUT POWER					
1 dB Compression	P1dB		10		dBm
RETURN LOSS					
RF Port			10		dB
LO Port			12		dB

## ABSOLUTE MAXIMUM RATINGS

Table 3.

Parameter	Rating
RF Input Power	21 dBm
LO Input Power	21 dBm
IF Input Power	21 dBm
IF Source and Sink Current	2 mA
Channel Temperature	175°C
Continuous P <sub>DISS</sub> (T = 85°C) (Derate 4.44 mW/°C Above 85°C)	400 mW
Maximum Peak Reflow Temperature (MSL3) <sup>1</sup>	260°C
Storage Temperature Range	-65°C to +150°C
Operating Temperature Range	-40°C to +85°C
Electrostatic Discharge (ESD) Sensitivity	
Human Body Model (HBM)	2000 V (Class 2)
Field Induced Charged Device Model (FICDM)	1200 V (Class C5)

<sup>1</sup> See the Ordering Guide section.

Stresses at or above those listed under Absolute Maximum Ratings may cause permanent damage to the product. This is a stress rating only; functional operation of the product at these or any other conditions above those indicated in the operational section of this specification is not implied. Operation beyond the maximum operating conditions for extended periods may affect product reliability.

## THERMAL RESISTANCE

Thermal performance is directly linked to printed circuit board (PCB) design and operating environment. Careful attention to PCB thermal design is required.

$\theta_{JA}$  is the natural convection junction to ambient thermal resistance measured in a one cubic foot sealed enclosure.

$\theta_{JC}$  is the junction to case thermal resistance.

Table 4. Thermal Resistance

Package Type	$\theta_{JA}$	$\theta_{JC}$	Unit
E-12-4 <sup>1</sup>	120	225	°C/W

<sup>1</sup> See JEDEC standard JESD51-2 for additional information on optimizing the thermal impedance (PCB with 3 × 3 vias).

## ESD CAUTION



**ESD (electrostatic discharge) sensitive device.** Charged devices and circuit boards can discharge without detection. Although this product features patented or proprietary protection circuitry, damage may occur on devices subjected to high energy ESD. Therefore, proper ESD precautions should be taken to avoid performance degradation or loss of functionality.

# PIN CONFIGURATION AND FUNCTION DESCRIPTIONS



- NOTES**
1. NIC = NOT INTERNALLY CONNECTED. THESE PINS ARE NOT CONNECTED INTERNALLY. HOWEVER, ALL DATA SHOWN HEREIN WAS MEASURED WITH THESE PINS CONNECTED TO RF/DC GROUND EXTERNALLY.
  2. EXPOSED PAD. THE EXPOSED PAD MUST BE CONNECTED TO RF/DC GROUND.

13669-002

Figure 2. Pin Configuration

Table 5. Pin Function Descriptions

Pin No.	Mnemonic	Description
1, 3, 7, 9, 10, 12	GND	Ground. Connect these pins and package bottom to RF/dc ground. See Figure 3 for the GND interface schematic.
2	LO	Local Oscillator Port. This pin is ac-coupled and matched to 50 Ω. See Figure 4 for the LO interface schematic.
4, 6, 11	NIC	Not Internally Connected. These pins are not connected internally. However, all data shown herein was measured with these pins connected to RF/dc ground externally.
5	IF	Intermediate Frequency Port. This pin is dc-coupled. For applications not requiring operation to dc, block this pin externally using a series capacitor with a value that passes the necessary IF frequency range. For operation to dc, to prevent device malfunction or failure, this pin must not source or sink more than 2 mA of current. See Figure 5 for the IF interface schematic.
8	RF	Radio Frequency Port. This pin is ac-coupled and matched to 50 Ω. See Figure 6 for the RF interface schematic.
	EP	Exposed Pad. The exposed pad must be connected to RF/dc ground.

## INTERFACE SCHEMATICS



Figure 3. GND Interface

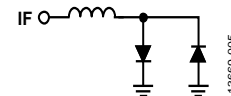

Figure 5. IF Interface

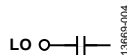

Figure 4. LO Interface

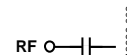

Figure 6. RF Interface

# TYPICAL PERFORMANCE CHARACTERISTICS

## DOWNCONVERTER, UPPER SIDEBAND, IF = 500 MHz

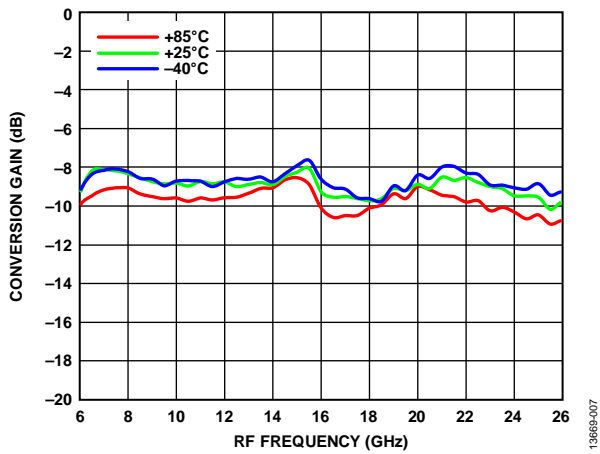

Figure 7. Conversion Gain vs. RF Frequency at Various Temperatures, LO Drive = 13 dBm

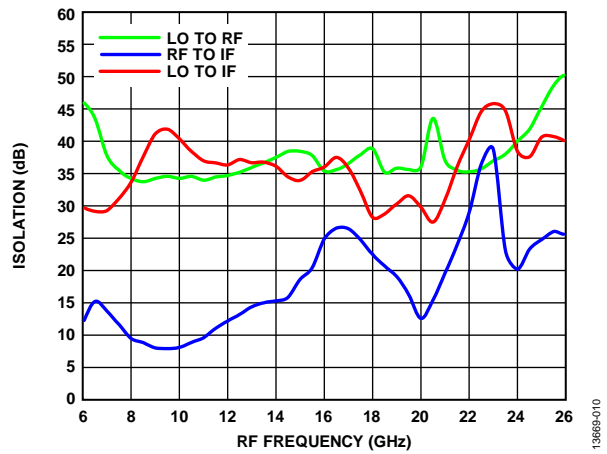

Figure 10. Isolation vs. RF Frequency

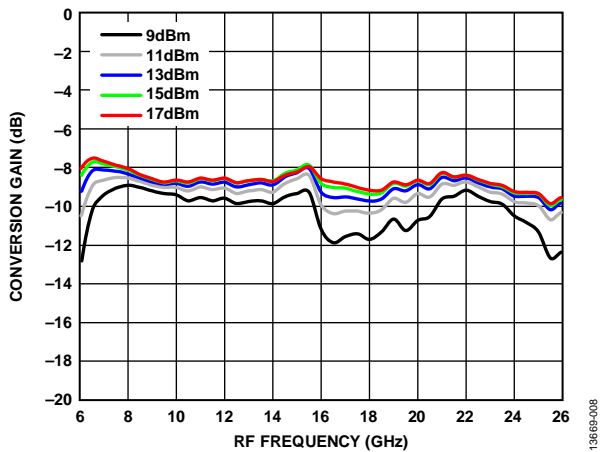

Figure 8. Conversion Gain vs. RF Frequency at Various LO Drives

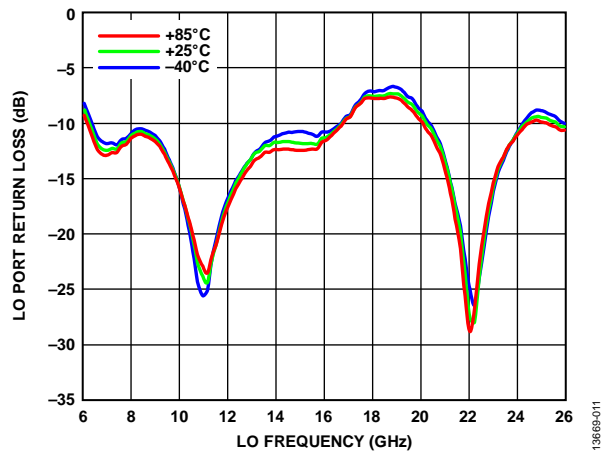

Figure 11. LO Port Return Loss vs. LO Frequency, LO Drive = 13 dBm

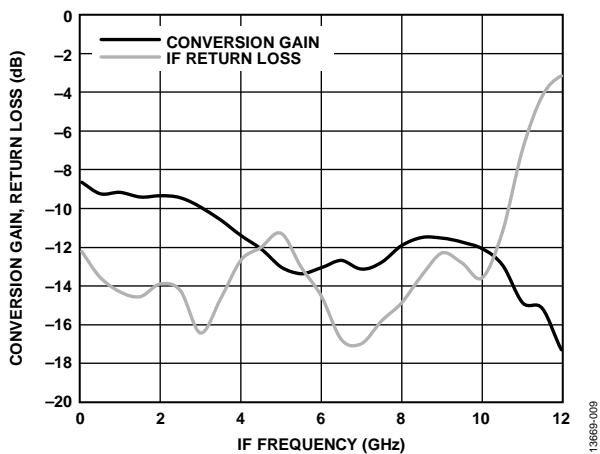

Figure 9. Conversion Gain and Return Loss vs. IF Frequency, LO Drive = 13 dBm

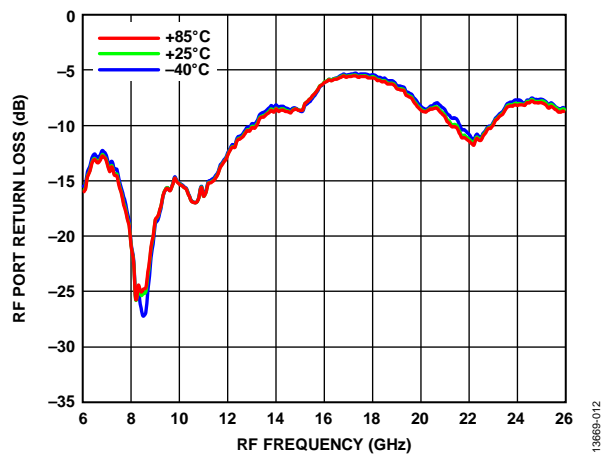

Figure 12. RF Port Return Loss vs. RF Frequency, LO Frequency = 16 GHz, LO Drive = 13 dBm

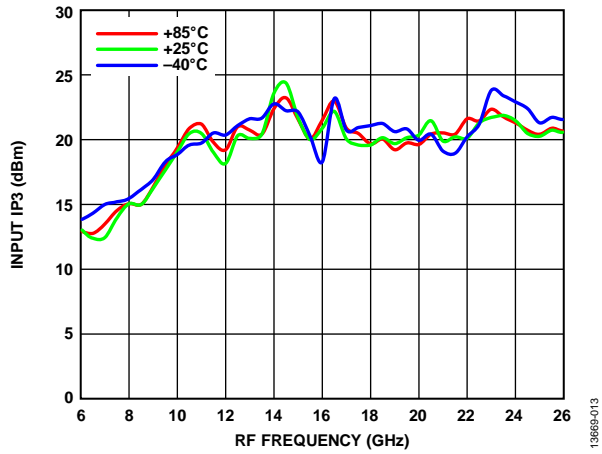

Figure 13. Input IP3 vs. RF Frequency at Various Temperatures, LO Drive = 13 dBm

13669-013

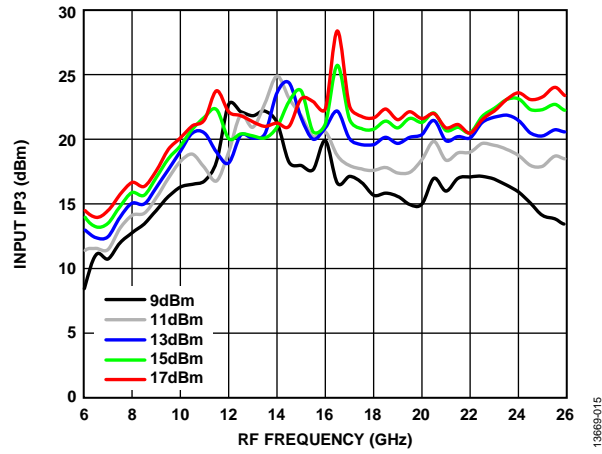

Figure 15. Input IP3 vs. RF Frequency at Various LO Drives

13669-015

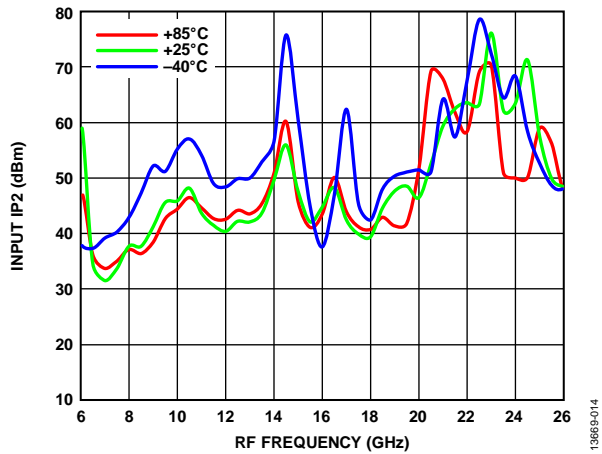

Figure 14. Input IP2 vs. RF Frequency at Various Temperatures, LO Drive = 13 dBm

13669-014

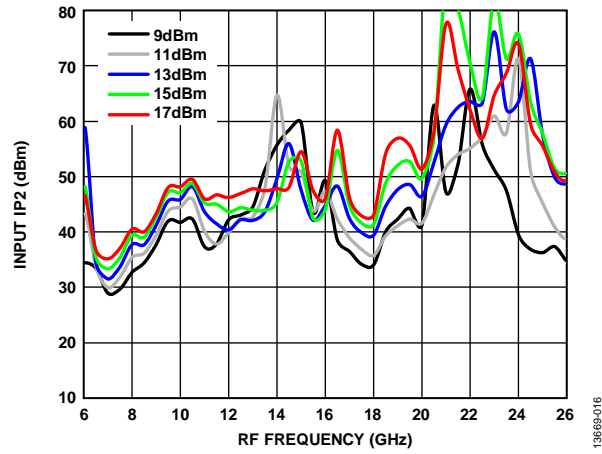

Figure 16. Input IP2 vs. RF Frequency at Various LO Drives

13669-016

DOWNCONVERTER, UPPER SIDEBAND, IF = 1000 MHz

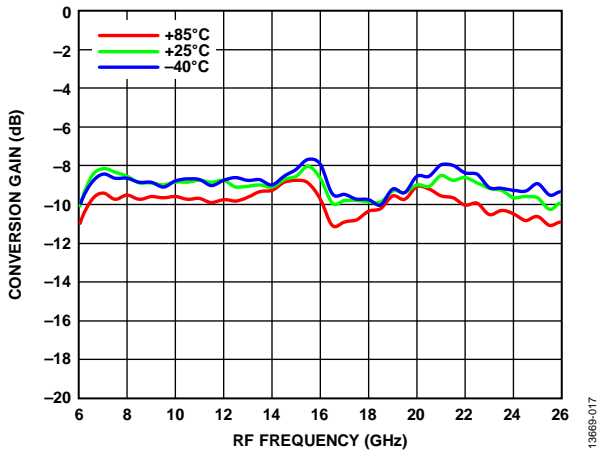

Figure 17. Conversion Gain vs. RF Frequency at Various Temperatures, LO Drive = 13 dBm

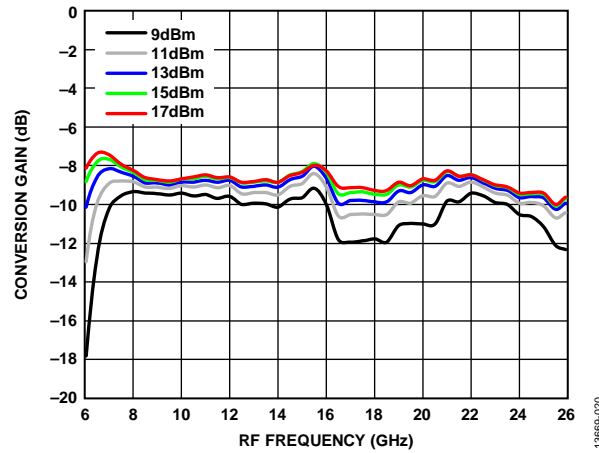

Figure 20. Conversion Gain vs. RF Frequency at Various LO Drives

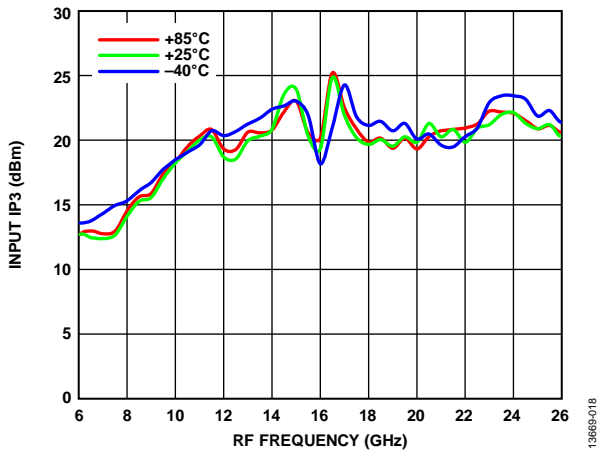

Figure 18. Input IP3 vs. RF Frequency at Various Temperatures, LO Drive = 13 dBm

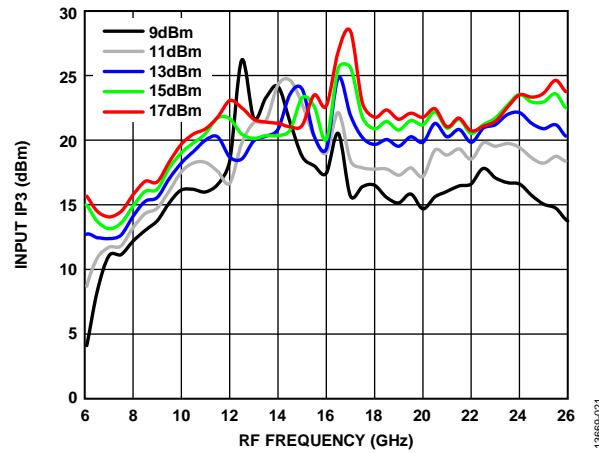

Figure 21. Input IP3 vs. RF Frequency at Various LO Drives

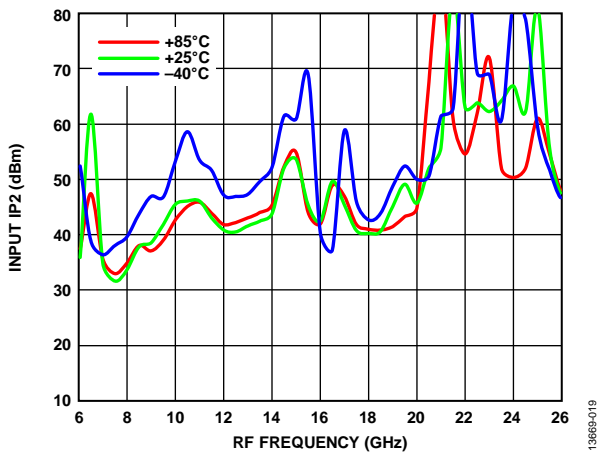

Figure 19. Input IP2 vs. RF Frequency at Various Temperatures, LO Drive = 13 dBm

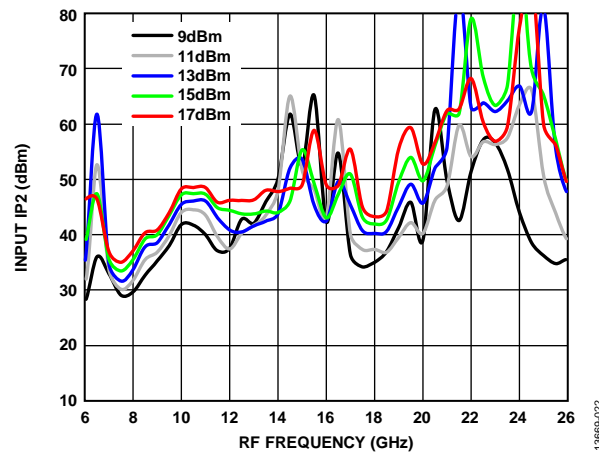

Figure 22. Input IP2 vs. RF Frequency at Various LO Drives



DOWNCONVERTER, UPPER SIDEBAND, IF = 3000 MHz

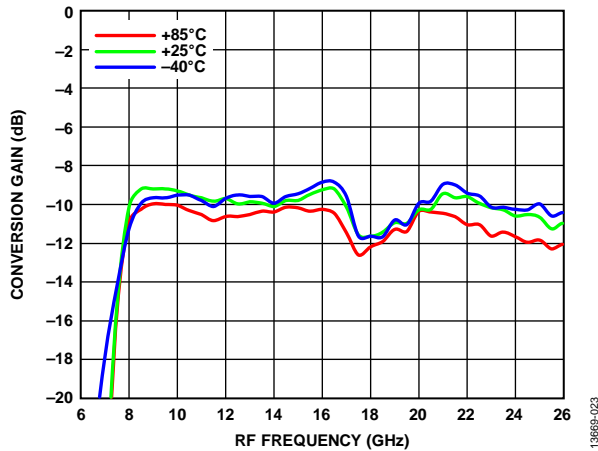

Figure 23. Conversion Gain vs. RF Frequency at Various Temperatures, LO Drive = 13 dBm

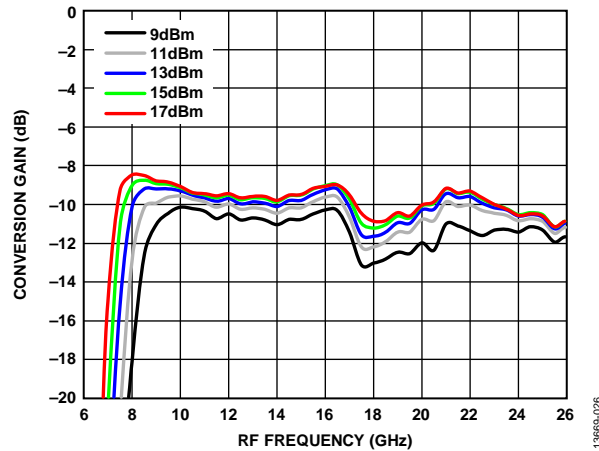

Figure 26. Conversion Gain vs. RF Frequency at Various LO Drives

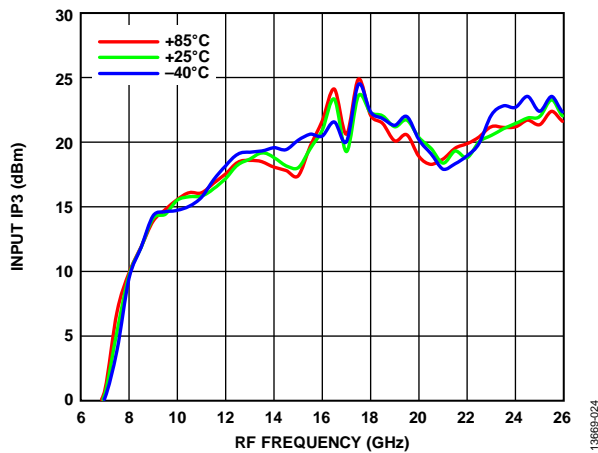

Figure 24. Input IP3 vs. RF Frequency at Various Temperatures, LO Drive = 13 dBm

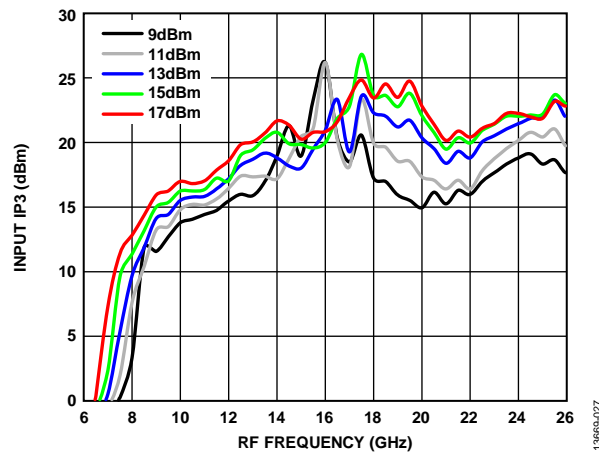

Figure 27. Input IP3 vs. RF Frequency at Various LO Drives

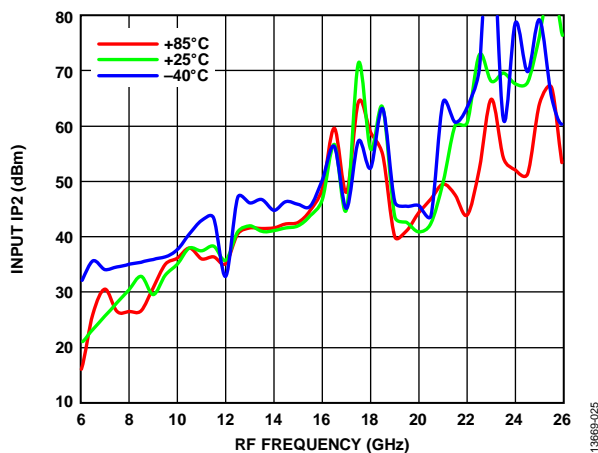

Figure 25. Input IP2 vs. RF Frequency at Various Temperatures, LO Drive = 13 dBm

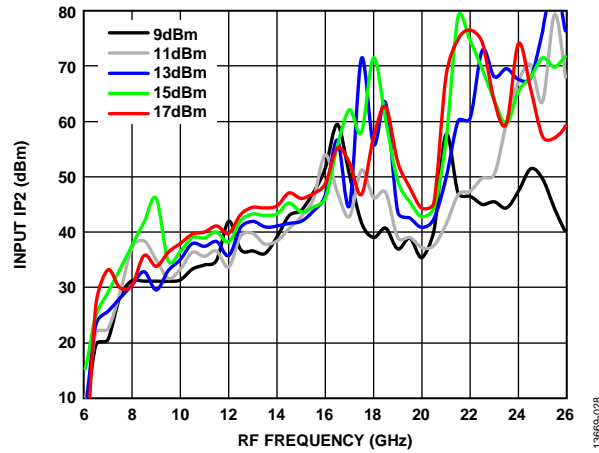

Figure 28. Input IP2 vs. RF Frequency at Various LO Drives

DOWNCONVERTER, UPPER SIDEBAND, IF = 7000 MHz

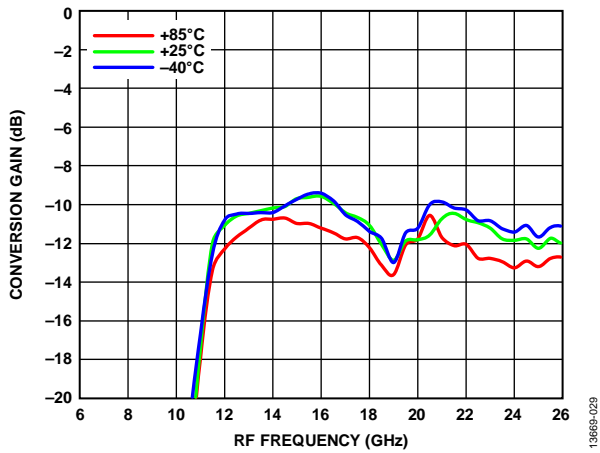

Figure 29. Conversion Gain vs. RF Frequency at Various Temperatures, LO Drive = 13 dBm

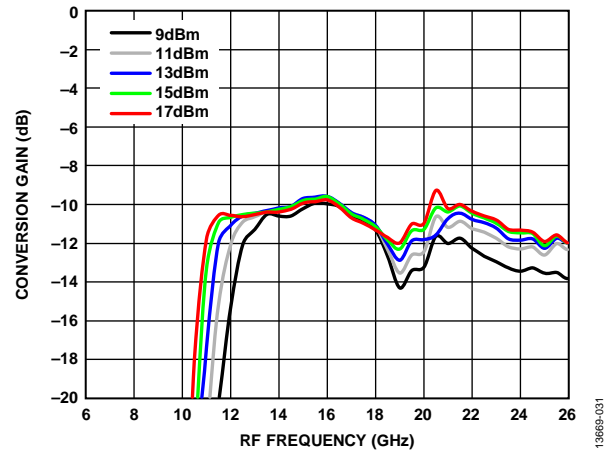

Figure 31. Conversion Gain vs. RF Frequency at Various LO Drives



Figure 30. Input IP3 vs. RF Frequency at Various Temperatures, LO Drive = 13 dBm



Figure 32. Input IP3 vs. RF Frequency at Various LO Drives

DOWNCONVERTER, LOWER SIDEBAND, IF = 500 MHZ

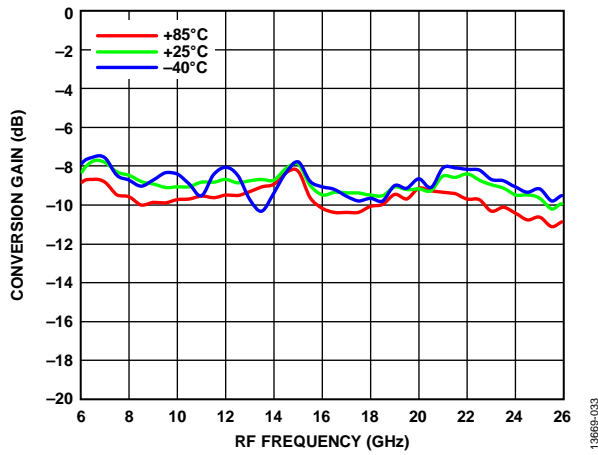

Figure 33. Conversion Gain vs. RF Frequency at Various Temperatures, LO Drive = 13 dBm

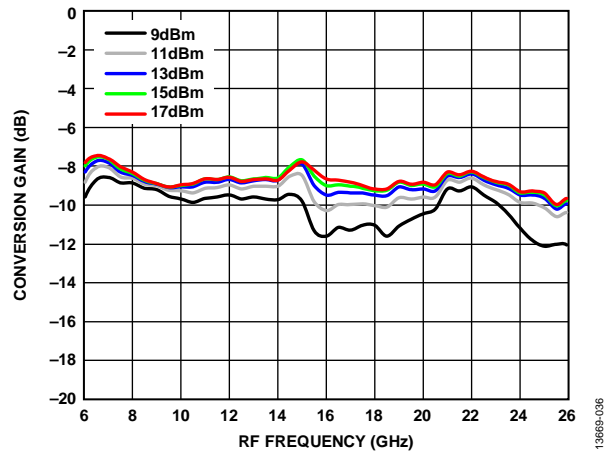

Figure 36. Conversion Gain vs. RF Frequency at Various LO Drives

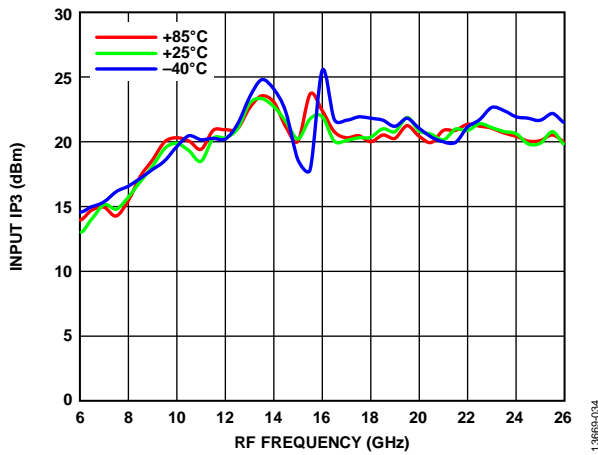

Figure 34. Input IP3 vs. RF Frequency at Various Temperatures, LO Drive = 13 dBm

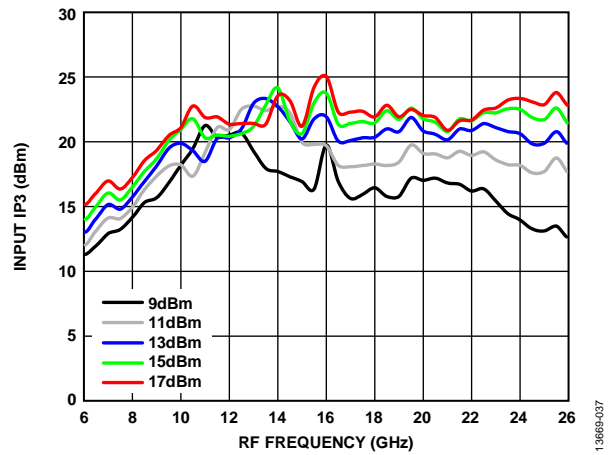

Figure 37. Input IP3 vs. RF Frequency at Various LO Drives

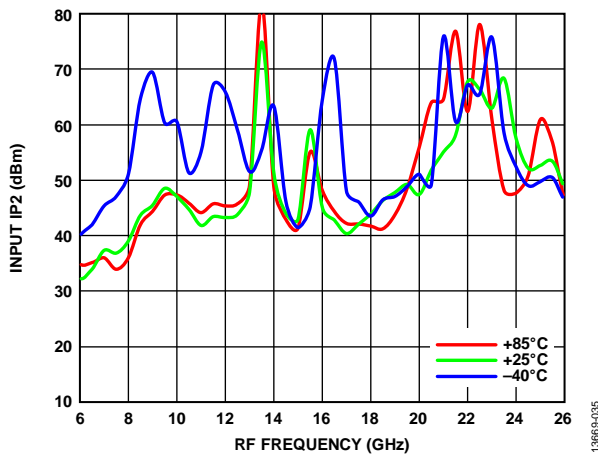

Figure 35. Input IP2 vs. RF Frequency at Various Temperatures, LO Drive = 13 dBm



Figure 38. Input IP2 vs. RF Frequency at Various LO Drives

DOWNCONVERTER, LOWER SIDEBAND, IF = 1000 MHz



Figure 39. Conversion Gain vs. RF Frequency at Various Temperatures, LO Drive = 13 dBm



Figure 42. Conversion Gain vs. RF Frequency at Various LO Drives



Figure 40. Input IP3 vs. RF Frequency at Various Temperatures, LO Drive = 13 dBm



Figure 43. Input IP3 vs. RF Frequency at Various LO Drives



Figure 41. Input IP2 vs. RF Frequency at Various Temperatures, LO Drive = 13 dBm



Figure 44. Input IP2 vs. RF Frequency at Various LO Drives

DOWNCONVERTER, LOWER SIDEBAND, IF = 3000 MHz

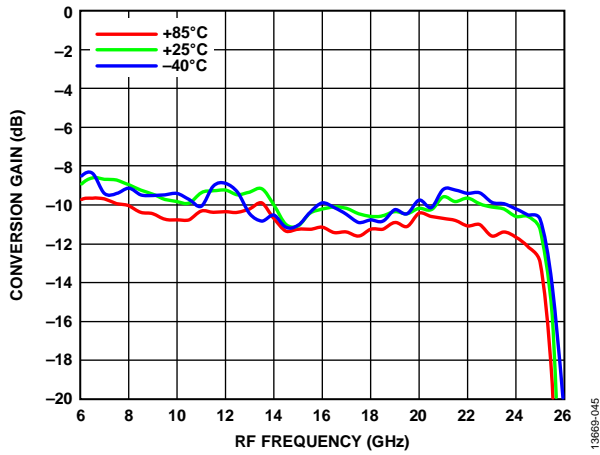

Figure 45. Conversion Gain vs. RF Frequency at Various Temperatures, LO Drive = 13 dBm

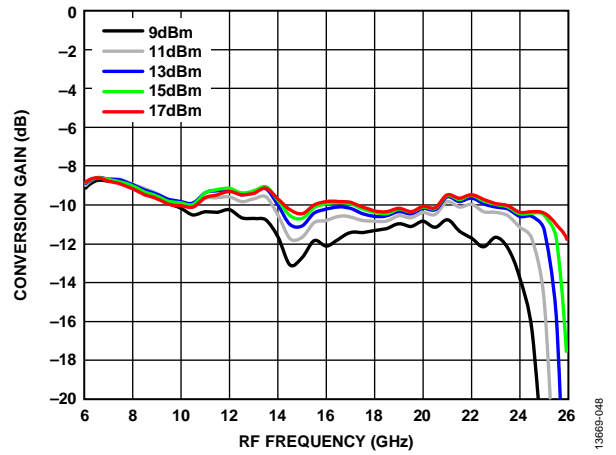

Figure 48. Conversion Gain vs. RF Frequency at Various LO Drives

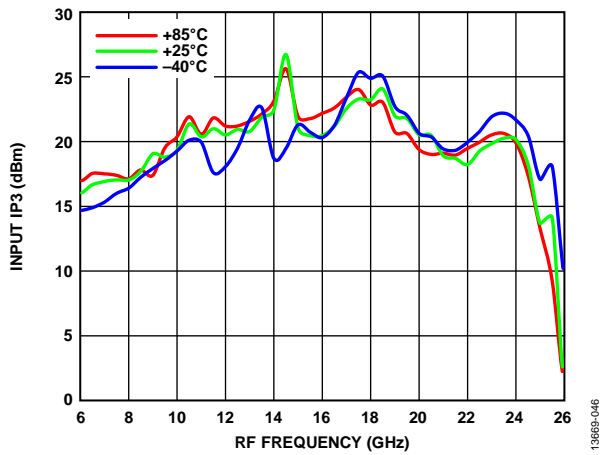

Figure 46. Input IP3 vs. RF Frequency at Various Temperatures, LO Drive = 13 dBm

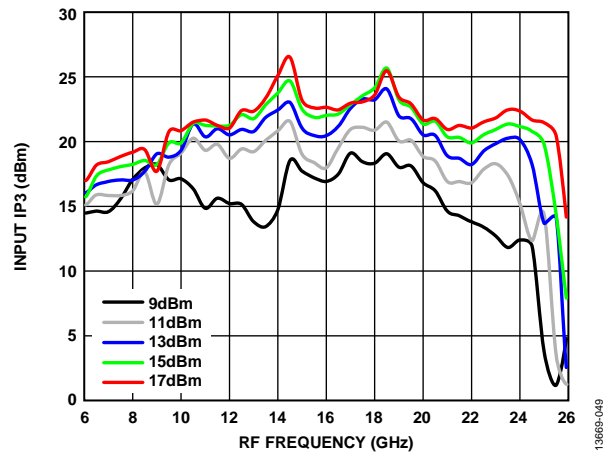

Figure 49. Input IP3 vs. RF Frequency at Various LO Drives

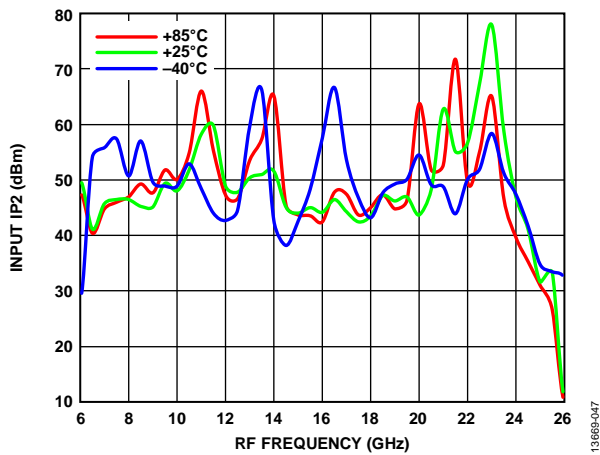

Figure 47. Input IP2 vs. RF Frequency at Various Temperatures, LO Drive = 13 dBm

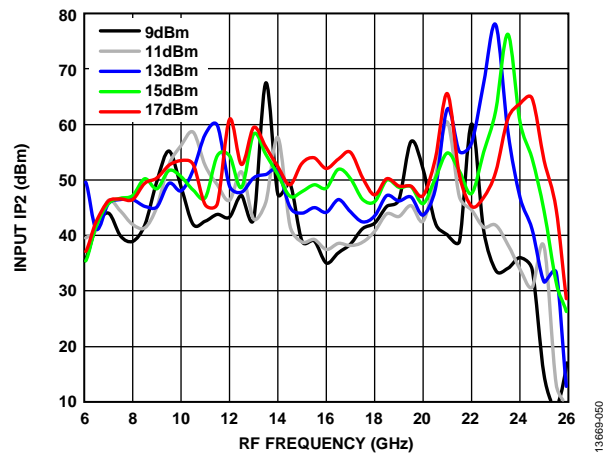

Figure 50. Input IP2 vs. RF Frequency at Various LO Drives

DOWNCONVERTER, LOWER SIDEBAND, IF = 7000 MHz

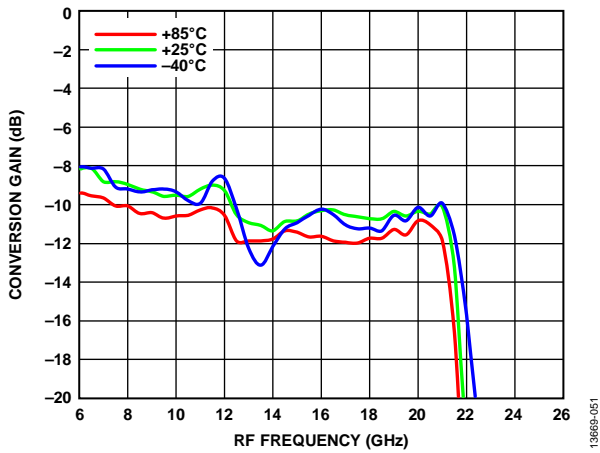

Figure 51. Conversion Gain vs. RF Frequency at Various Temperatures, LO Drive = 13 dBm

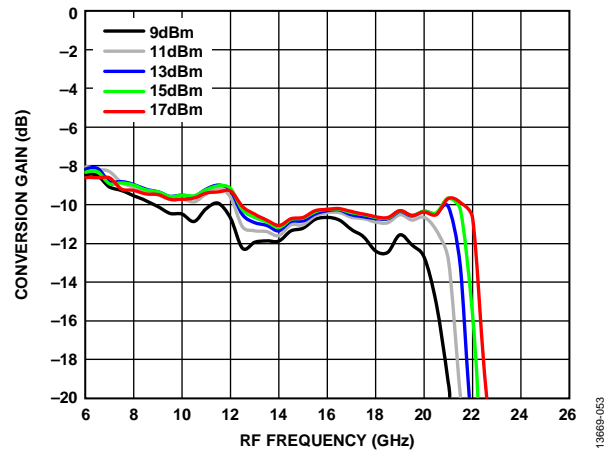

Figure 53. Conversion Gain vs. RF Frequency at Various LO Drives

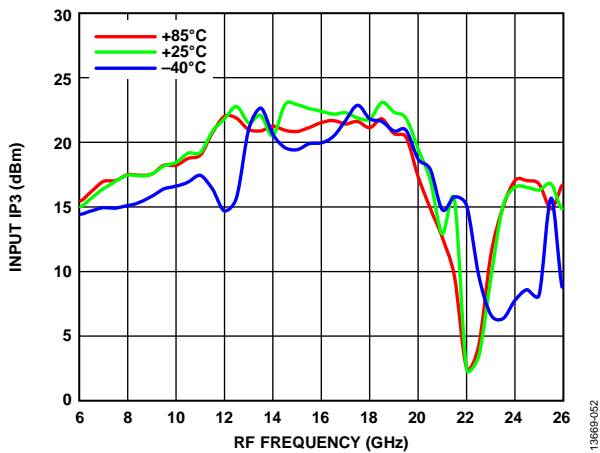

Figure 52. Input IP3 vs. RF Frequency at Various Temperatures, LO Drive = 13 dBm

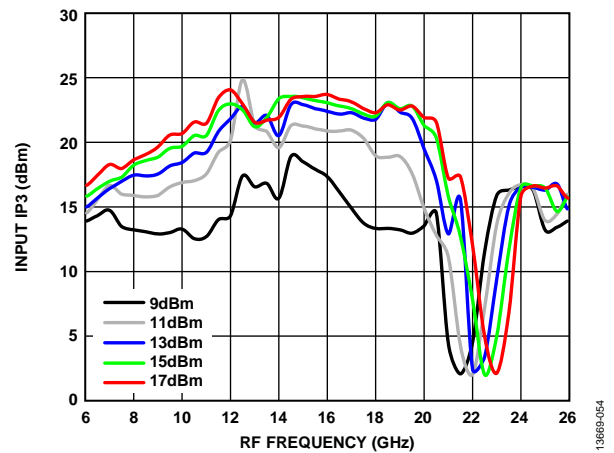

Figure 54. Input IP3 vs. RF Frequency at Various LO Drives

**DOWNCONVERTER, P1dB PERFORMANCE**

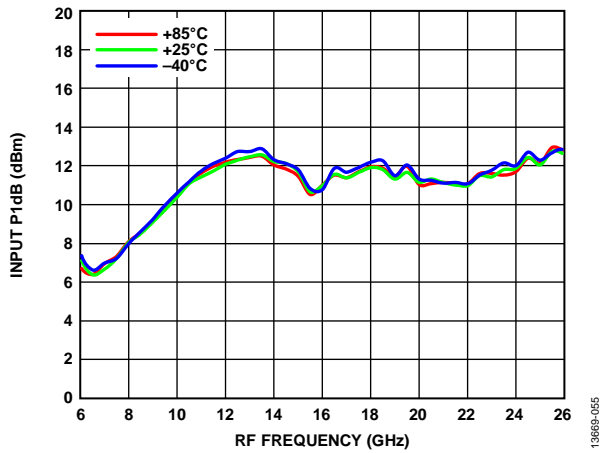

Figure 55. Input P1dB vs. RF Frequency at Various Temperatures, IF = 500 MHz, LO Drive = 13 dBm, Upper Sideband

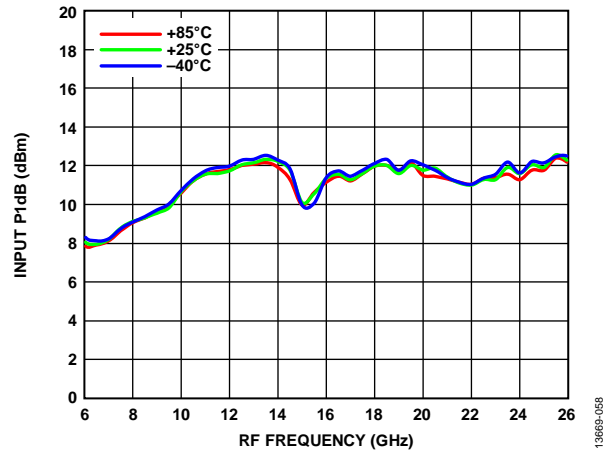

Figure 58. Input P1dB vs. RF Frequency at Various Temperatures, IF = 500 MHz, LO Drive = 13 dBm, Lower Sideband

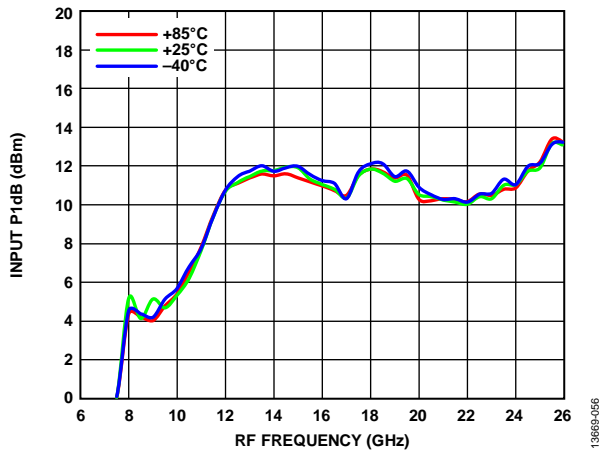

Figure 56. Input P1dB vs. RF Frequency at Various Temperatures, IF = 3000 MHz, LO Drive = 13 dBm, Upper Sideband

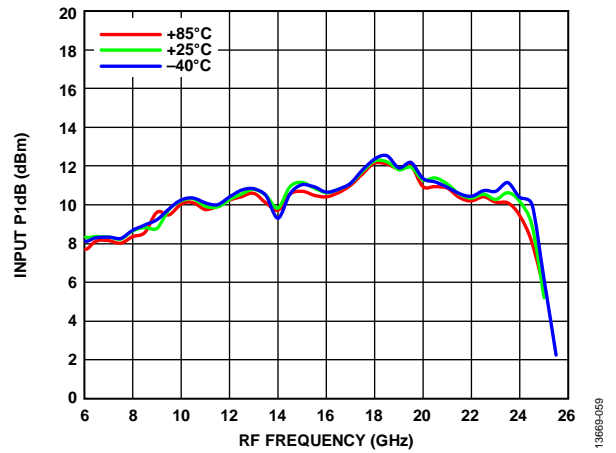

Figure 59. Input P1dB vs. RF Frequency at Various Temperatures, IF = 3000 MHz, LO Drive = 13 dBm, Lower Sideband

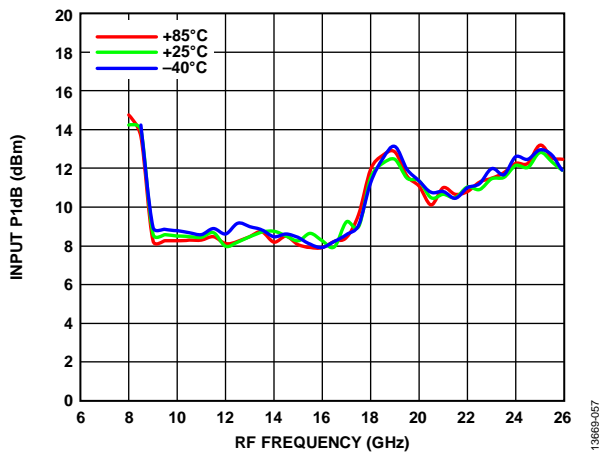

Figure 57. Input P1dB vs. RF Frequency at Various Temperatures, IF = 7000 MHz, LO Drive = 13 dBm, Upper Sideband

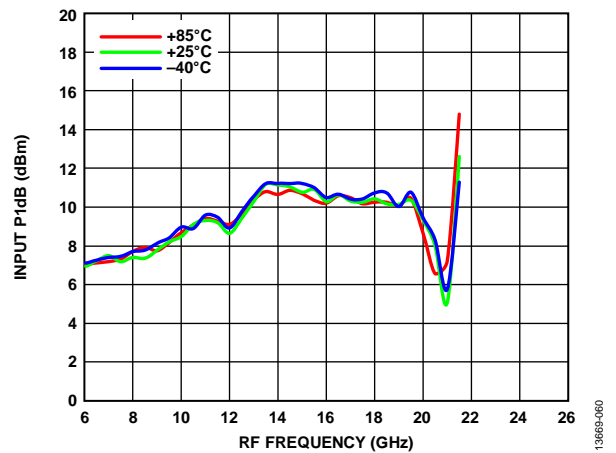

Figure 60. Input P1dB vs. RF Frequency at Various Temperatures, IF = 7000 MHz, LO Drive = 13 dBm, Lower Sideband

13869-055

13869-058

13869-056

13869-059

13869-057

13869-060

UPCONVERTER, UPPER SIDEBAND



Figure 61. Conversion Gain vs. RF Frequency at Various Temperatures, LO Drive = 13 dBm, IF = 500 MHz



Figure 64. Input IP3 vs. RF Frequency at Various Temperatures, LO Drive = 13 dBm, IF = 500 MHz



Figure 62. Conversion Gain vs. RF Frequency at Various Temperatures, LO Drive = 13 dBm, IF = 3000 MHz



Figure 65. Input IP3 vs. RF Frequency at Various Temperatures, LO Drive = 13 dBm, IF = 3000 MHz



Figure 63. Conversion Gain vs. RF Frequency at Various Temperatures, LO Drive = 13 dBm, IF = 7000 MHz



Figure 66. Input IP3 vs. RF Frequency at Various Temperatures, LO Drive = 13 dBm, IF = 7000 MHz



UPCONVERTER, LOWER SIDEBAND



Figure 67. Conversion Gain vs. RF Frequency at Various Temperatures, LO Drive = 13 dBm, IF = 500 MHz



Figure 70. Input IP3 vs. RF Frequency at Various Temperatures, LO Drive = 13 dBm, IF = 500 MHz

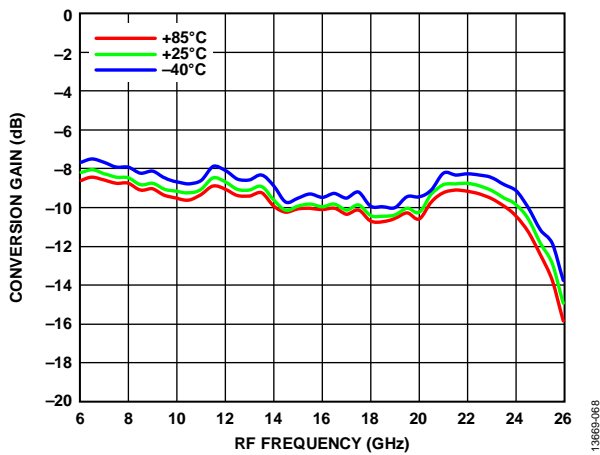

Figure 68. Conversion Gain vs. RF Frequency at Various Temperatures, LO Drive = 13 dBm, IF = 3000 MHz

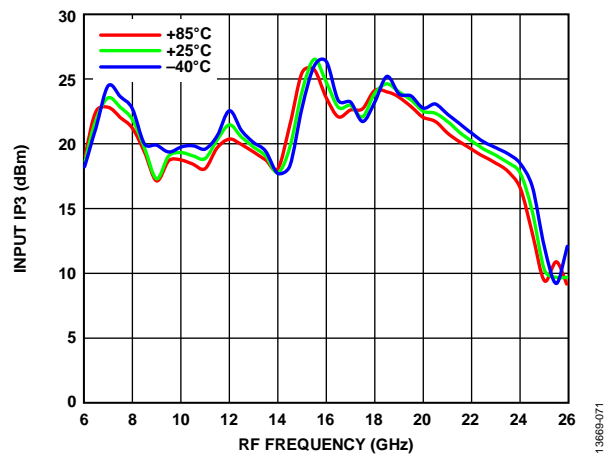

Figure 71. Input IP3 vs. RF Frequency at Various Temperatures, LO Drive = 13 dBm, IF = 3000 MHz

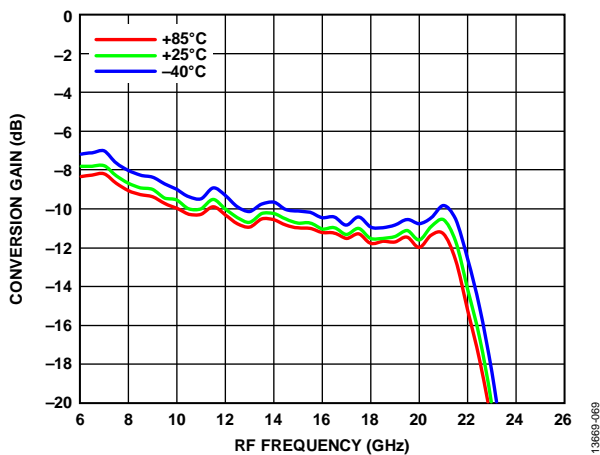

Figure 69. Conversion Gain vs. RF Frequency at Various Temperatures, LO Drive = 13 dBm, IF = 7000 MHz

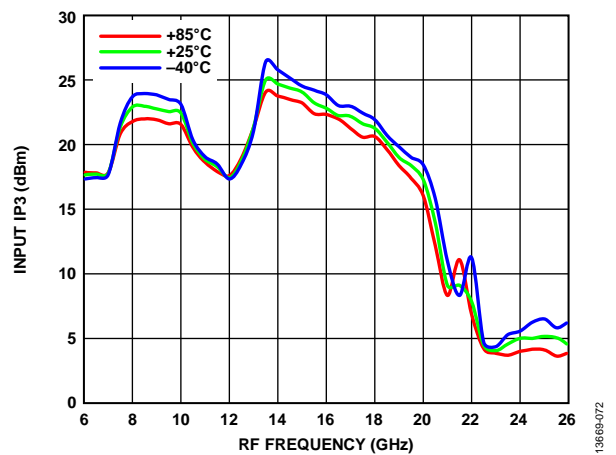

Figure 72. Input IP3 vs. RF Frequency at Various Temperatures, LO Drive = 13 dBm, IF = 7000 MHz

**NOISE FIGURE PERFORMANCE**



Figure 73. Noise Figure vs. RF Frequency at Various Temperatures, Upper Sideband, IF = 500 MHz, LO Drive = 13 dBm (with LO Amplifier in Line with Lab Bench LO Source)



Figure 75. Noise Figure vs. RF Frequency at Various Temperatures, Upper Sideband, IF = 500 MHz, LO Drive = 13 dBm (Without LO Amplifier in Line with Lab Bench LO Source)



Figure 74. Noise Figure vs. RF Frequency at Various Temperatures, Lower Sideband, IF = 500 MHz, LO Drive = 13 dBm (with LO Amplifier in Line with Lab Bench LO Source)



Figure 76. Noise Figure vs. RF Frequency at Various Temperatures, Lower Sideband, IF = 500 MHz, LO Drive = 13 dBm (Without LO Amplifier in Line with Lab Bench LO Source)

**SPURIOUS PERFORMANCE**

Mixer spurious products are measured in dBc from the IF output power level. Spurious values are (M × RF) – (N × LO). N/A means not applicable.

**M × N Spurious Outputs, IF = 500 MHz**

The RF frequency = 9 GHz and RF input power = –10 dBm.  
The LO frequency = 8.5 GHz and the LO input power = 13 dBm.

		N × LO					
		0	1	2	3	4	5
M × RF	0	N/A	+14	+33.9	+42.7	+74.4	+50.1
	1	–0.7	0	+18.4	+47.7	+46.1	+71.3
	2	+63.8	+58	+58.3	+64.4	+67.3	+86
	3	+73.1	+78.8	+53.1	+56.1	+62.6	+82.3
	4	+80.3	+90	+95.1	+95.2	+94.6	+97.3
	5	+78	+84.4	+88.7	+91.9	+87.5	+93.5

The RF frequency = 16 GHz and RF input power = –10 dBm.  
The LO frequency = 15.5 GHz and the LO input power = 13 dBm.

		N × LO					
		0	1	2	3	4	5
M × RF	0	N/A	10.5	47.3	44.1	N/A	N/A
	1	17.8	0	38.8	56.4	65.2	N/A
	2	85.1	63.9	51.6	66.3	83.3	629.7
	3	76.6	82.7	89.5	58.3	85.4	87.2
	4	N/A	74	89.9	91.3	97.4	92
	5	N/A	N/A	76.2	91.3	89.1	100.5

The RF frequency = 23 GHz and RF input power = –10 dBm.  
The LO frequency = 22.5 GHz and the LO input power = 13 dBm.

		N × LO					
		0	1	2	3	4	5
M × RF	0	N/A	11.2	38.7	N/A	N/A	N/A
	1	10.4	0	39.9	55.6	N/A	N/A
	2	78.1	69.7	58.8	73.1	76.3	N/A
	3	N/A	76.6	88.9	60.8	87.6	77
	4	N/A	N/A	78.5	91.6	91.8	87.3
	5	N/A	N/A	N/A	79	91.7	97.5

**M × N Spurious Outputs, IF = 1000 MHz**

The RF frequency = 9 GHz and RF input power = –10 dBm.  
The LO frequency = 8 GHz and the LO input power = 13 dBm.

		N × LO					
		0	1	2	3	4	5
M × RF	0	N/A	+11.9	+26.4	+62.6	+72.3	+49.1
	1	–0.4	0	+17.6	+61.1	+59	+68.2
	2	+63.4	+59.5	+59	+62.5	+90.4	+84.8
	3	+73.9	+77.1	+55.2	+53.7	+68.1	+77
	4	+81.6	+88.4	+91.2	+84.4	+98.2	+91.5
	5	+76.5	+85	+88.2	+89.8	+99.1	+98.1

The RF frequency = 16 GHz and RF input power = –10 dBm.  
The LO frequency = 15 GHz and the LO input power = 13 dBm.

		N × LO					
		0	1	2	3	4	5
M × RF	0	N/A	7.7	45.4	N/A	N/A	N/A
	1	17.7	0	35.3	63.7	N/A	N/A
	2	83.8	61.4	51.5	71	81.1	N/A
	3	75.6	88.5	74.9	58.7	79.1	76.1
	4	N/A	75	90	71.2	100.4	89.9
	5	N/A	N/A	75.7	91.1	95.4	99.2

The RF frequency = 23 GHz and RF input power = –10 dBm.  
The LO frequency = 22 GHz and the LO input power = 13 dBm.

		N × LO					
		0	1	2	3	4	5
M × RF	0	N/A	13.2	35.1	N/A	N/A	N/A
	1	10.4	0	41	57.6	N/A	N/A
	2	77.1	73.9	59.1	73.1	73	N/A
	3	N/A	77.3	91.8	60.5	89.3	N/A
	4	N/A	N/A	78.2	92.4	93.6	91.3
	5	N/A	N/A	N/A	77.3	93	100.1

## THEORY OF OPERATION

The [HMC773ALC3B](#) is a general-purpose, double balanced mixer that can be used as an upconverter or a downconverter from 6 GHz to 26 GHz.

When used as a downconverter, the [HMC773ALC3B](#) downconverts radio frequencies (RF) between 6 GHz and 26 GHz to intermediate frequencies (IF) between dc and 8 GHz.

When used as an upconverter, the mixer upconverts intermediate frequencies between dc and 8 GHz to radio frequencies between 6 GHz and 26 GHz.

The mixer performs well with LO drives of 13 dBm or above, and it provides excellent LO to RF and LO to IF suppression due to optimized balun structures. The ceramic LCC package eliminates the need for wire bonding and is compatible with high volume, surface-mount manufacturing techniques.

# APPLICATIONS INFORMATION

## TYPICAL APPLICATION CIRCUIT

Figure 77 shows the typical application circuit for the HMC773ALC3B. The HMC773ALC3B is a passive device and does not require any external components. The LO and RF pins are internally ac-coupled. When IF operation is not required until dc, it is recommended to use an ac-coupled capacitor at the IF port. When IF operation to dc is required, do not exceed the IF source and sink current rating specified in the Absolute Maximum Ratings section.

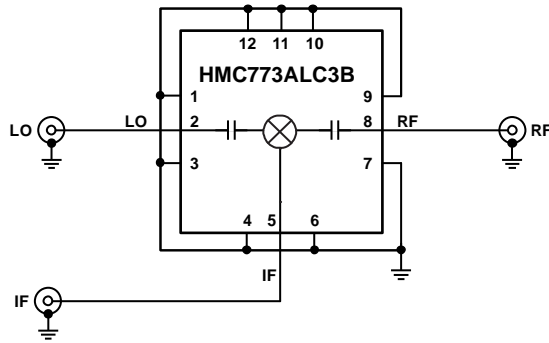

Figure 77. Typical Application Circuit

13669-077

## EVALUATION PCB INFORMATION

RF circuit design techniques must be implemented for the evaluation board PCB shown in Figure 78. Signal lines must have 50 Ω impedance, and the package ground leads and exposed pad must be connected directly to the ground plane, similar to that shown in Figure 78. Use a sufficient number of via holes to connect the top and bottom ground planes. The evaluation circuit board shown in Figure 78 is available from Analog Devices, Inc., upon request.

Table 6. Bill of Materials for Evaluation PCB  
EV1HMC773ALC3B

Item	Description
J1, J2	SRI SMA connector.
J3	Johnson SMA connector.
U1	HMC773ALC3B mixer.
PCB <sup>1</sup>	125040 evaluation PCB. Circuit board material: Rogers 4350.

<sup>1</sup> 125040 is the bare PCB. Reference EV1HMC773ALC3B when ordering the evaluation PCB assembly.

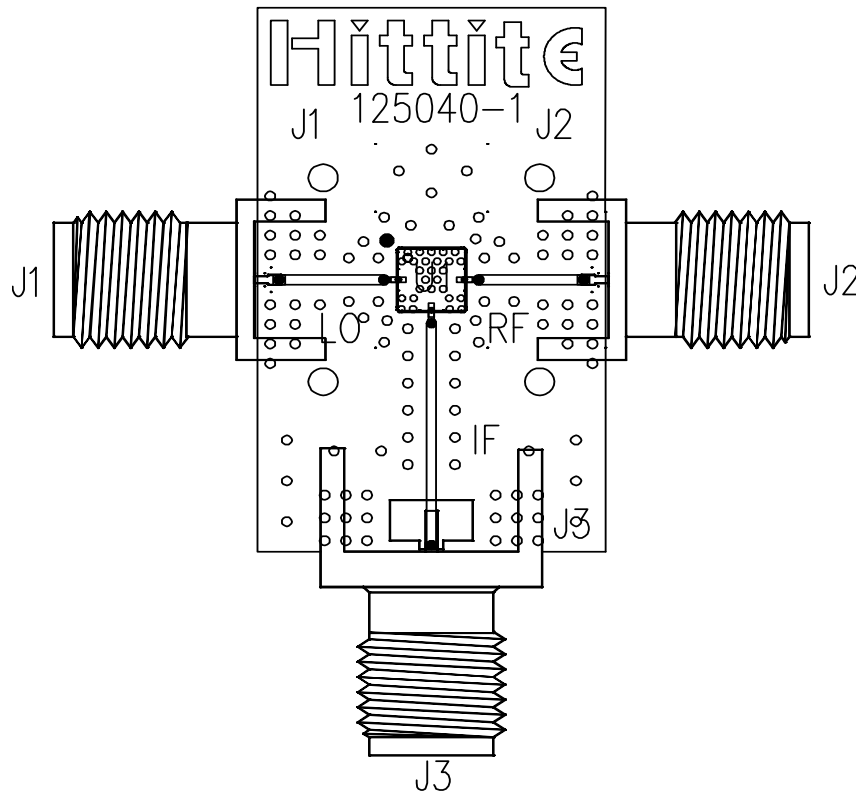

Figure 78. Evaluation PCB

13669-089

OUTLINE DIMENSIONS



Figure 79. 12-Terminal Ceramic Leadless Chip Carrier [LCC] (E-12-4)  
Dimensions shown in millimeters

ORDERING GUIDE

Model <sup>1</sup>	Temperature Range	MSL Rating <sup>2</sup>	Description <sup>3</sup>	Package Option
HMC773ALC3B	-40°C to +85°C	MSL3	12-Terminal Ceramic Leadless Chip Carrier [LCC]	E-12-4
HMC773ALC3BTR	-40°C to +85°C	MSL3	12-Terminal Ceramic Leadless Chip Carrier [LCC]	E-12-4
HMC773ALC3BTR-R5	-40°C to +85°C	MSL3	12-Terminal Ceramic Leadless Chip Carrier [LCC]	E-12-4
EV1HMC773ALC3B			Evaluation PCB Assembly	

<sup>1</sup> All models are RoHS-Compliant Parts.

<sup>2</sup> The maximum peak reflow temperature is 260°C (see the Absolute Maximum Ratings section).

<sup>3</sup> HMC773ALC3B, HMC773ALC3BTR, and HMC773ALC3BTR-R5 body package material is alumina ceramic and the lead finish is gold over nickel.

## X-ON Electronics

Largest Supplier of Electrical and Electronic Components

*Click to view similar products for [RF Mixer](#) category:*

*Click to view products by [Analog Devices](#) manufacturer:*

Other Similar products are found below :

[F1751NBGI](#) [MD-169-PIN](#) [MD-154-PIN](#) [CHR3664-QEG](#) [M85C](#) [LTC5567IUF#TRPBF](#) [HMC553ALC3BTR-R5](#) [HMC787ALC3BTR-R5](#)  
[LTC5541IUH#TRPBF](#) [SIM-63LH+](#) [MCA1-24+](#) [SIM-24MH+](#) [F1192BNLGK8](#) [AD608ARZ-RL](#) [EMRS-1TR](#) [F0552NLGI](#) [F1701NBGI](#)  
[F0502NLGI](#) [F1763NBGI](#) [MDS-189-PIN](#) [MAMXSS0012TR-3000](#) [M2TC](#) [M2A](#) [CSM4T](#) [LTC5553IUDB#TRMPBF](#) [LT5527EUF#PBF](#)  
[LTC5577IUF#PBF](#) [M1H](#) [LTC5548IUDB#TRMPBF](#) [MY63H](#) [SMA5101-TL-H](#) [ADL5801ACPZ](#) [AD831APZ](#) [AD831APZ-REEL7](#)  
[ADL5350ACPZ-R7](#) [ADL5801ACPZ-R7](#) [HMC219BMS8GETR](#) [HMC220BMS8GE](#) [HMC412BMS8GE](#) [HMC557ALC4](#) [HMC557ALC4TR](#)  
[HMC787ALC3BTR](#) [LT5560EDD#PBF](#) [GRF7001](#) [HMC220BMS8GETR](#) [CSM4T17](#) [CSM4TH](#) [CSM5TH](#) [MAMX-011021-TR1000](#) [MAMX-011035-TR0100](#)