

### FEATURES

- Wideband Design: 20 – 42 GHz
- Wide IF Bandwidth: 0 – 5 GHz
- Conversion Loss: -8.5 dB
- High IIP3: 22 dBm
- High Image Rejection: 25 dB
- High LO-RF Isolation: 45 dB
- Reduces need for IF filtering

### APPLICATIONS

- Test and Measurement Instrumentation
- Military, Radar and Aerospace

### FUNCTIONAL BLOCK DIAGRAM

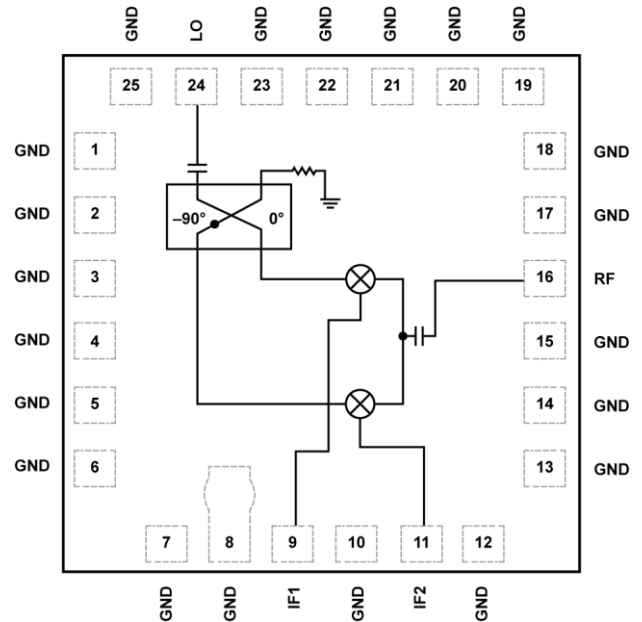

Figure 1.

### GENERAL DESCRIPTION

**HMC8192** is a passive wideband I/Q MMIC mixer that can be used either as an image reject mixer for receiver operations or as a single sideband upconverter for transmitter operations. With an RF and LO range of 20 GHz to 42 GHz, and an IF bandwidth of DC to 5 GHz, the **HMC8192** is ideal for applications requiring wide frequency range, excellent RF performance, and a simpler design with fewer parts and a smaller printed circuit board (PCB) footprint. A single **HMC8192** can replace multiple narrowband mixers in a design. The inherent I/Q architecture of the **HMC8192** offers excellent image rejection and thereby eliminates the need for expensive filtering for unwanted sidebands. The mixer also provides

excellent LO to RF and LO to IF isolation and reduces the effect of LO leakage to ensure signal integrity

Being a passive mixer, the **HMC8192** does not require any DC power sources. It offers a lower noise figure compared to an active mixer, ensuring superior dynamic range for high performance and precision applications.

The **HMC8192** is fabricated on a GaAs MESFET process and uses Analog Devices, Inc., mixer cells and a 90-degree hybrid. It is available in a compact 4 mm × 4 mm, 25-lead LGA package and operates over a -40°C to +85°C temperature range. An evaluation board for this device is also available.

**TABLE OF CONTENTS**

Features .....	1	Pin Configuration and Function Descriptions.....	5
Applications.....	1	Typical Performance Characteristics .....	6
Functional Block Diagram .....	1	$f_{RFIN}$ at 100 MHz.....	6
General Description .....	1	$f_{RFIN}$ at 2.5 GHz.....	7
Specifications.....	3	$f_{RFIN}$ at 5 GHz .....	8
Absolute Maximum Ratings.....	4	Evaluation Board .....	9
ESD Caution.....	4	Outline Dimensions.....	11

## SPECIFICATIONS

$f_{IF\ OUT} = f_{RF\ IN} - f_{LO}$  (downconverter, upper sideband),  $f_{RF\ IN} = 0.1\ \text{GHz to } 5\ \text{GHz}$ ,  $P_{RF\ IN} = -10\ \text{dBm}$ ,  $P_{LO} = +18\ \text{dBm}$ ,  $T_A = 25^\circ\text{C}$ .

Table 1.

Parameter	Test Conditions	Min	Typ	Max	Unit
<b>RF INPUT INTERFACE</b>					
Return Loss			TBD		dB
Input Impedance			TBD		$\Omega$
RF Input Frequency Range		20		42	GHz
<b>IF INTERFACE</b>					
Return Loss			TBD		dB
IF Impedance			TBD		$\Omega$
IF Frequency Range		DC		5	GHz
<b>LO INTERFACE</b>					
LO Power		15	18	22	dBm
Return Loss			TBD		dB
Input Impedance			TBD		$\Omega$
LO Frequency Range		20		42	GHz
<b>DOWNCONVERTER DYNAMIC PERFORMANCE at <math>f_{IF\ OUT} = 100\ \text{MHz}</math></b>					
Conversion Loss			TBD		dB
Input Third-Order Intercept			TBD		dBm
Image Rejection			TBD		dB
LO to RF Isolation <sup>1</sup>			TBD		dB
LO to IF Isolation <sup>1</sup>			TBD		dB
RF to IF Isolation <sup>1</sup>			TBD		dB
Phase Balance			TBD		Degrees
Amplitude Balance			TBD		dB
<b>DOWNCONVERTER DYNAMIC PERFORMANCE at <math>f_{IF\ OUT} = 2.5\ \text{GHz}</math></b>					
Conversion Loss			TBD		dB
Input Third-Order Intercept			TBD		dBm
Image Rejection			TBD		dB
LO to RF Isolation <sup>1</sup>			TBD		dB
LO to IF Isolation <sup>1</sup>			TBD		dB
RF to IF Isolation <sup>1</sup>			TBD		dB
Phase Balance			TBD		Degrees
Amplitude Balance			TBD		dB
<b>DOWNCONVERTER DYNAMIC PERFORMANCE at <math>f_{IF\ OUT} = 5\ \text{GHz}</math></b>					
Conversion Loss			TBD		dB
Input Third-Order Intercept			TBD		dBm
Image Rejection			TBD		dB
LO to RF Isolation <sup>1</sup>			TBD		dB
LO to IF Isolation <sup>1</sup>			TBD		dB
RF to IF Isolation <sup>1</sup>			TBD		dB
Balance			TBD		Degrees
Amplitude Balance			TBD		dB

<sup>1</sup> See the Typical Performance Characteristics section.

## ABSOLUTE MAXIMUM RATINGS

Table 2.

Parameter	Rating
RFIN Power	TBD
LO Drive	TBD
Channel Temperature	TBD
Continuous $P_{DISS}$ ( $T = 85^{\circ}\text{C}$ ) (Derate 9.8 mW/ $^{\circ}\text{C}$ above 85 $^{\circ}\text{C}$ )	TBD
Thermal Resistance ( $R_{\theta JH}$ ) (Junction to Die Bottom)	TBD
Operating Temperature Range	-40 $^{\circ}\text{C}$ to +85 $^{\circ}\text{C}$
Storage Temperature Range	-65 $^{\circ}\text{C}$ to +150 $^{\circ}\text{C}$
ESD Sensitivity (HBM)	TBD

Stresses above those listed under Absolute Maximum Ratings may cause permanent damage to the device. This is a stress rating only; functional operation of the device at these or any other conditions above those indicated in the operational section of this specification is not implied. Exposure to absolute maximum rating conditions for extended periods may affect device reliability.

### ESD CAUTION



**ESD (electrostatic discharge) sensitive device.** Charged devices and circuit boards can discharge without detection. Although this product features patented or proprietary protection circuitry, damage may occur on devices subjected to high energy ESD. Therefore, proper ESD precautions should be taken to avoid performance degradation or loss of functionality.

### PIN CONFIGURATION AND FUNCTION DESCRIPTIONS

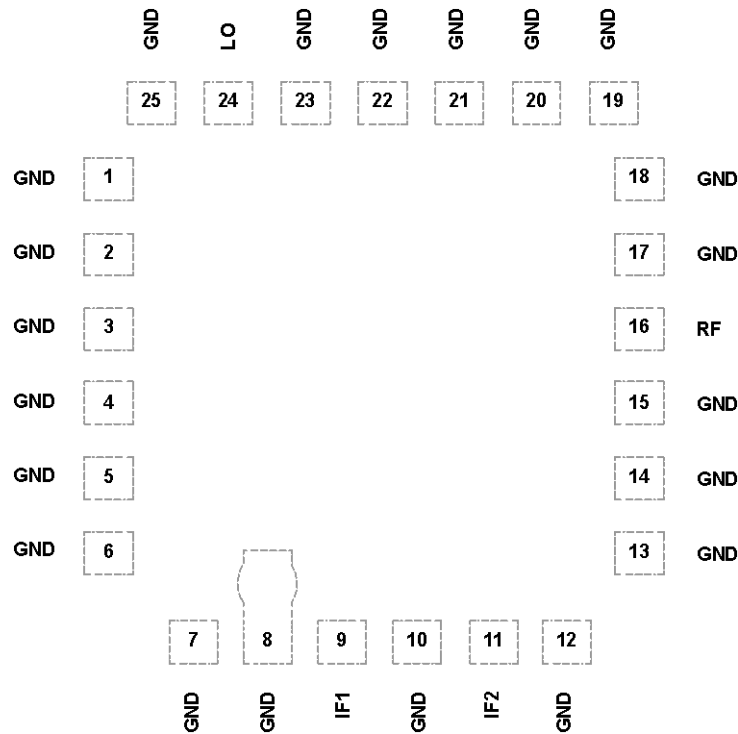

Figure 2. Pin Configuration

Table 3. Pin Function Descriptions

Pin No.	Mnemonic	Description
1 – 8, 10, 12 – 15, 17 – 23, 25 9, 11	GND IF1, IF2	Ground. These pins and package bottom must be connected to RF/dc ground. These pins are dc-coupled. For applications not requiring operations to dc, this port should be dc blocked externally using a series capacitor whose value is selected to pass the necessary IF frequency range. For operations to dc, this pin must not source/sink more than 3 mA of current, otherwise, the device does not function and may fail.
16	RF	This pin is dc-coupled and matched to 50 Ω.
24	LO	This pin is dc-coupled and matched to 50 Ω.

### TYPICAL PERFORMANCE CHARACTERISTICS

**f<sub>RF IN</sub> at 100 MHz**

f<sub>IF OUT</sub> = f<sub>LO</sub> - f<sub>RF IN</sub> (downconverter, lower sideband), f<sub>RF IN</sub> = 100 MHz, P<sub>RF IN</sub> = -10 dBm, P<sub>LO</sub> = 18 dBm, T<sub>A</sub> = 25°C.

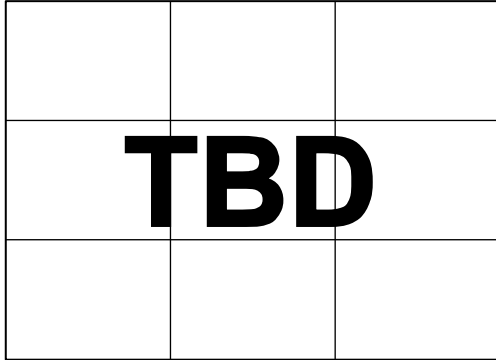

Figure 3. Image Rejection, Downconverter

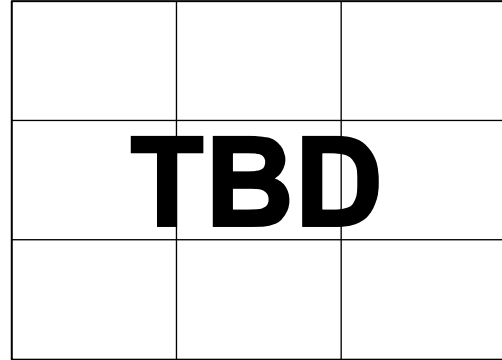

Figure 5. Input IP3, Downconverter

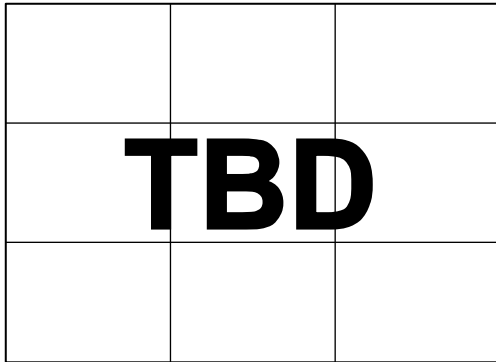

Figure 4. RF to IF Isolation, Downconverter

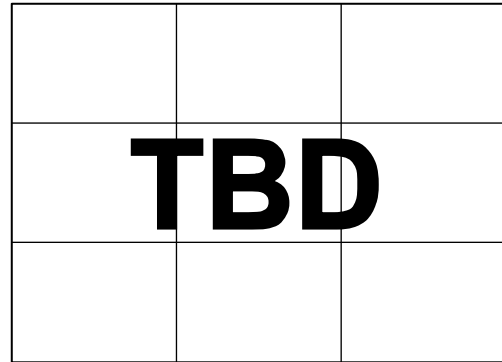

Figure 6. LO to IF Isolation, Downconverter

**f<sub>RFIN</sub> at 2.5 GHz**

f<sub>IF OUT</sub> = f<sub>LO</sub> - f<sub>RFIN</sub> (downconverter, lower sideband), f<sub>RFIN</sub> = 2.5 GHz, P<sub>RFIN</sub> = -10dBm, P<sub>LO</sub> = 14 dBm, 16 dBm, 18 dBm, 20 dBm, T<sub>A</sub> = 25°C.

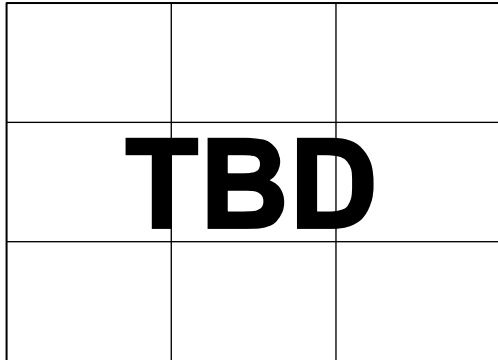

Figure 7. Conversion Loss, Downconverter

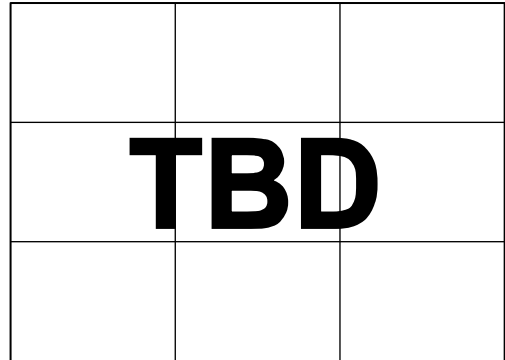

Figure 10. Input IP3, Downconverter

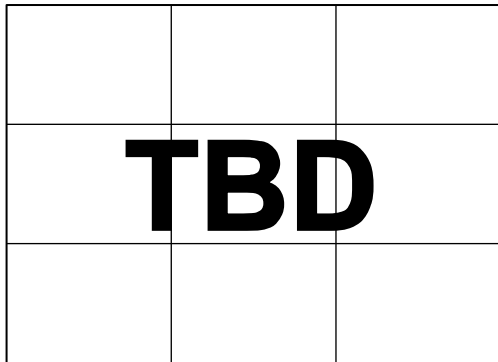

Figure 8. Image Rejection, Downconverter

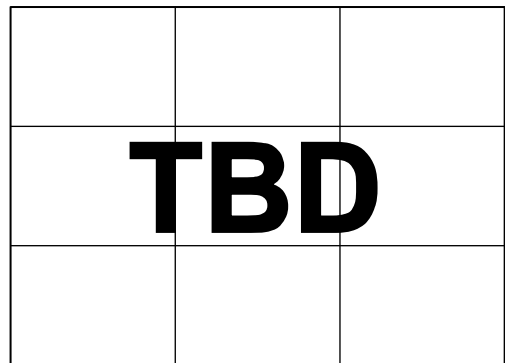

Figure 11. LO to RF Isolation, Downconverter

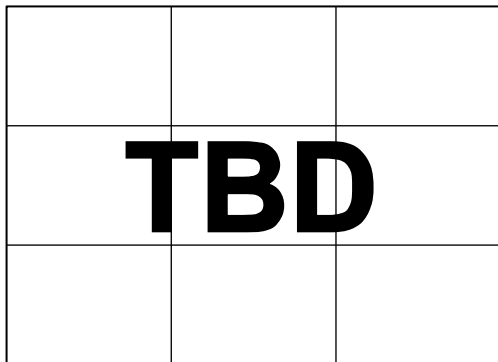

Figure 9. Amplitude Balance, Downconverter

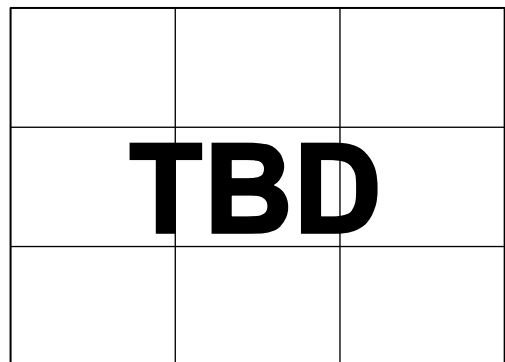

Figure 12. Phase Balance, Downconverter

**f<sub>RF IN</sub> at 5 GHz**

f<sub>IF OUT</sub> = f<sub>LO</sub> - f<sub>RF IN</sub> (downconverter, lower sideband), f<sub>RF IN</sub> = 5 GHz, P<sub>RF IN</sub> = -10dBm, P<sub>LO</sub> = 14 dBm, 16 dBm, 18 dBm, 20 dBm, T<sub>A</sub> = 25°C.

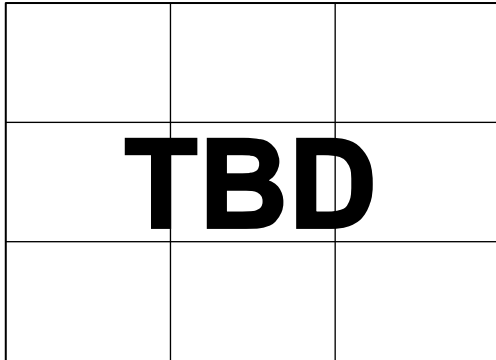

Figure 13. Conversion Loss, Downconverter

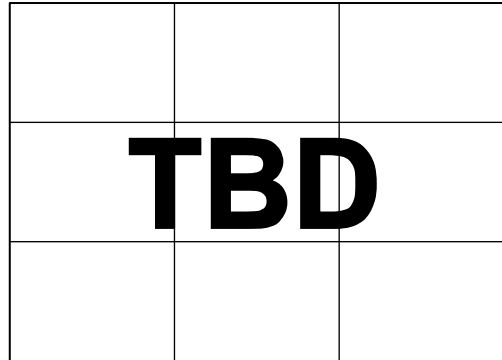

Figure 15. Input IP3, Downconverter

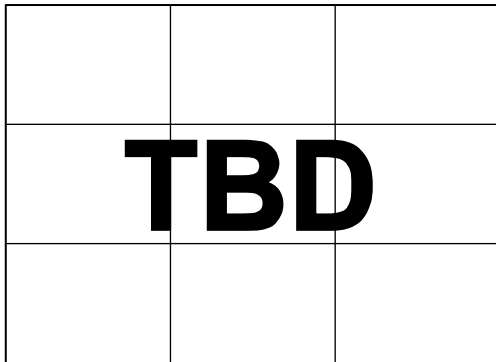
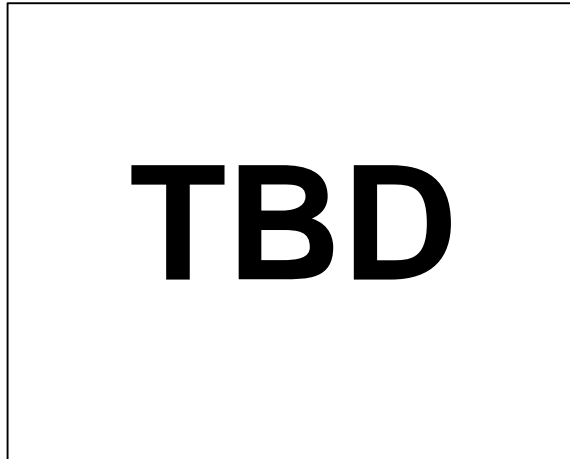

Figure 14. Image Rejection, Downconverter



## EVALUATION BOARD

An evaluation board is available for the [HMC8192](#). The standard evaluation board is fabricated using Rogers® RO4003C material. The schematic for the evaluation board is shown in Figure 16.



*Figure 16. Evaluation Board Schematic*

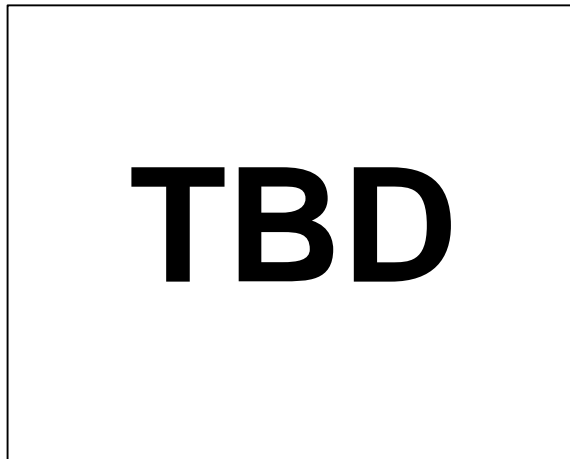

*Figure 17. Evaluation Board, Top Layer*

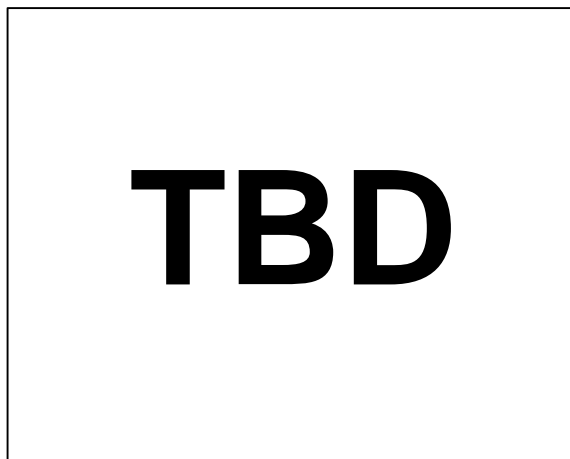

*Figure 18. Evaluation Board, Bottom Layer*

Table 4 describes the various configuration options for the evaluation board. Layouts for the board are shown in Figure 17 and Figure 18.

**Table 4. Evaluation Board Configuration**

<b>Components</b>	<b>Function</b>	<b>Default Conditions</b>
TBD		

OUTLINE DIMENSIONS

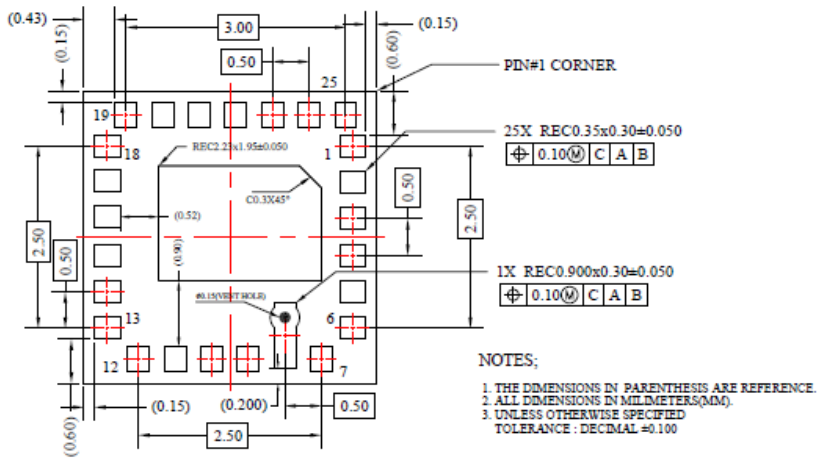
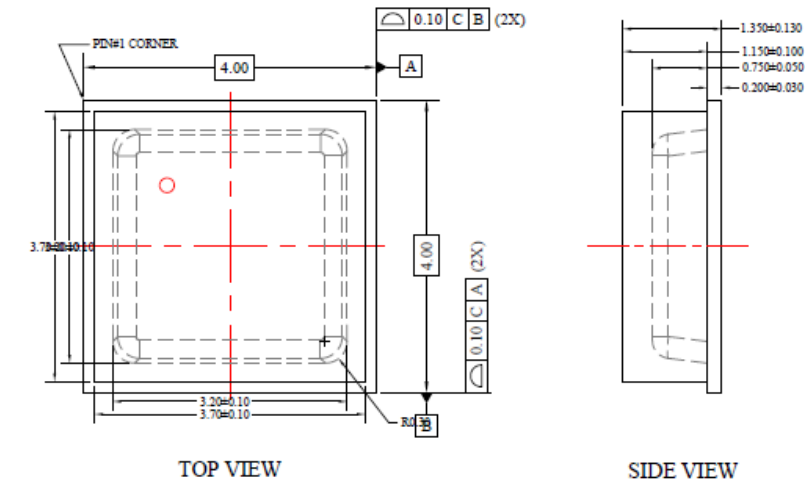

Figure 19. HMC8192 Outline Drawing and Dimensions

## X-ON Electronics

Largest Supplier of Electrical and Electronic Components

*Click to view similar products for [RF Mixer](#) category:*

*Click to view products by [Analog Devices](#) manufacturer:*

Other Similar products are found below :

[HMC337-SX](#) [HMC404-SX](#) [mamx-009646-23dbml](#) [HMC339-SX](#) [HMC8192-SX](#) [MIQ24MS-2](#) [HMC220BMS8GETR](#) [M85C](#) [HMC554A-SX](#)  
[HMC8192LG](#) [HMC521A-SX](#) [HMC521ACHIPS](#) [CMD258C4](#) [LT5511EFE](#) [MAMX-011023-SMB](#) [HMC399MS8TR](#) [HMC333TR](#)  
[HMC214MS8TR](#) [HMC175MS8TR](#) [MAMXSS0012TR-3000](#) [109728-HMC129LC4](#) [CSM1-13](#) [SA612AD/01.112](#) [HMC785LP4ETR](#)  
[LT5526EUF#PBF](#) [LT5579IUH#PBF](#) [HMC773ALC3BTR](#) [HMC558ALC3B](#) [HMC329ALC3B](#) [MY63H](#) [AD8343ARUZ-REEL7](#) [AD608AR](#)  
[AD608ARZ](#) [AD831APZ](#) [AD831APZ-REEL7](#) [AD8342ACPZ-REEL7](#) [AD8343ARUZ](#) [AD8344ACPZ-REEL7](#) [ADL5350ACPZ-R7](#)  
[ADL5363ACPZ-R7](#) [ADL5365ACPZ-R7](#) [ADL5801ACPZ-R7](#) [ADL5802ACPZ-R7](#) [HMC1056LP4BE](#) [HMC1057-SX](#) [HMC1063LP3E](#)  
[HMC1093-SX](#) [HMC1106-SX](#) [HMC129](#) [HMC143](#)