





## FRACTIONAL-N PLL WITH INTEGRATED VCO 25 - 3000 MHz

### General Description

The HMC830LP6GE is a low noise, wide band, Fractional-N Phase-Locked-Loop (PLL) that features an integrated Voltage Controlled Oscillator (VCO) with a fundamental frequency of 1500 MHz - 3000 MHz, and an integrated VCO Output Divider (divide by 1/2/4/6.../60/62), that together allow the HMC830LP6GE to generate frequencies from 25 MHz to 3000 MHz. The integrated Phase Detector (PD) and delta-sigma modulator, capable of operating at up to 100 MHz, permit wider loop-bandwidths with excellent spectral performance.

The HMC830LP6GE features industry leading phase noise and spurious performance, across all frequencies, that enable it to minimize blocker effects, and improve receiver sensitivity and transmitter spectral purity. The superior noise floor (< -170 dBc/Hz) makes the HMC830LP6GE an ideal source for a variety of applications - such as; LO for RF mixers, a clock source for high-frequency data-converters, or a tunable reference source for ultra-low spurious applications.

Additional features of the HMC830LP6GE include RF output power control from 0 to 9 dB (3 dB steps), output Mute function, and a delta-sigma modulator Exact Frequency Mode which enables users to generate output frequencies with 0 Hz frequency error.

For theory of operation and register map refer to the [“PLLs with Integrated VCOs - RF VCOs Operating Guide”](#). To view the Operating Guide, please visit [www.hittite.com](http://www.hittite.com) and choose HMC830LP6GE from the “Search by Part Number” pull down menu.

### Electrical Specifications

**VPPCP, VDDLs, VCC1, VCC2 = 5 V; RVDD, AVDD, DVDD3V, VCCPD, VCCHF, VCCPS = 3.3 V**  
**Min and Max Specified across Temp -40 °C to 85 °C**

| Parameter   | Condition   | Min. | Typ.        | Max.    | Units |
|---|---|------|-------------|---------|-------|
| <b>RF Output Characteristics</b>  |   |      |             |         |       |
| Output Frequency  |   | 25   |             | 3000    | MHz   |
| VCO Frequency at PLL Input  |   | 1500 |             | 3000    | MHz   |
| RF Output Frequency at $f_{VCO}$  |   | 1500 |             | 3000    | MHz   |
| <b>Output Power</b>   |   |      |             |         |       |
| RF Output Power at $f_{VCO} = 2000$ MHz<br>Across All Frequencies see <a href="#">Figure 10</a> | Broadband Matched Internally<br>[1]                                 | 4.5  | 6           | 7.5     | dBm   |
| Output Power Control  | 3 dB Steps  | 7    |             | 9       | dB    |
| <b>Harmonics</b>  |   |      |             |         |       |
| $f_0$ Mode at 2 GHz   | 2nd / 3rd / 4th   |      | -20/-29/-45 |         | dBc   |
| $f_0/2$ Mode at 2GHz/2 = 1 GHz  | 2nd / 3rd / 4th   |      | -23/-15/-35 |         | dBc   |
| $f_0/30$ Mode at 3 GHz/30 = 100 MHz   | 2nd / 3rd / 4th   |      | -25/-10/-33 |         | dBc   |
| $f_0/62$ Mode at 1550 MHz/62 = 25 MHz   | 2nd / 3rd / 4th   |      | -17/-8/-21  |         | dBc   |
| <b>VCO Output Divider</b>   |   |      |             |         |       |
| VCO RF Divider Range  | 1,2,4,6,8,...,62  | 1    |             | 62      |       |
| <b>PLL RF Divider Characteristics</b>   |   |      |             |         |       |
| 19-Bit N-Divider Range (Integer)  | Max = $2^{19} - 1$  | 16   |             | 524,287 |       |
| 19-Bit N-Divider Range (Fractional)   | Fractional nominal divide ratio<br>varies (-3 / +4) dynamically max | 20   |             | 524,283 |       |
| <b>REF Input Characteristics</b>  |   |      |             |         |       |
| Max Ref Input Frequency   |   |      |             | 350     | MHz   |
| Ref Input Voltage   | AC Coupled<br>[2]   | 1    | 2           | 3.3     | Vp-p  |
| Ref Input Capacitance   |   |      |             | 5       | pF    |

[1] Measured single-ended. Additional 3 dB possible with differential outputs.

[2] Measured with 100  $\Omega$  external termination. See [Hittite PLL w/ Integrated VCOs Operating Guide](#) Reference Input Stage section for more details.

## FRACTIONAL-N PLL WITH INTEGRATED VCO 25 - 3000 MHz



### Electrical Specifications (Continued)

| Parameter  | Condition                               | Min. | Typ. | Max.   | Units  |
|--|---|------|------|--------|--------|
| 14-Bit R-Divider Range                                       |   | 1    |      | 16,383 |        |
| <b>Phase Detector (PD) [3]</b>                               |   |      |      |        |        |
| PD Frequency Fractional Mode B                               | [4]                                     | DC   |      | 100    | MHz    |
| PD Frequency Fractional Mode A (and Register 6 [17:16] = 11) |   | DC   |      | 80     | MHz    |
| PD Frequency Integer Mode                                    |   | DC   |      | 125    | MHz    |
| <b>Charge Pump</b>   |   |      |      |        |        |
| Output Current   |   | 0.02 |      | 2.54   | mA     |
| Charge Pump Gain Step Size                                   |   |      | 20   |        | μA     |
| PD/Charge Pump SSB Phase Noise                               | 50 MHz Ref, Input Referred              |      |      |        |        |
| 1 kHz  |   |      | -143 |        | dBc/Hz |
| 10 kHz   | Add 1 dB for Fractional                 |      | -150 |        | dBc/Hz |
| 100 kHz  | Add 3 dB for Fractional                 |      | -153 |        | dBc/Hz |
| <b>Logic Inputs</b>  |   |      |      |        |        |
| Vsw  |   | 40   | 50   | 60     | % DVDD |
| <b>Logic Outputs</b>   |   |      |      |        |        |
| VOH Output High Voltage                                      |   |      | DVDD |        | V      |
| VOL Output Low Voltage                                       |   |      | 0    |        | V      |
| Output Impedance   |   | 100  |      | 200    | Ω      |
| Maximum Load Current   |   |      |      | 1.5    | mA     |
| <b>Power Supply Voltages</b>                                 |   |      |      |        |        |
| 3.3 V Supplies   | AVDD, VCCHF, VCCPS, VCCPD, RVDD, DVDD   | 3.0  | 3.3  | 3.5    | V      |
| 5 V Supplies   | VPPCP, VDDL, VCC1, VCC2                 | 4.8  | 5    | 5.2    | V      |
| <b>Power Supply Currents</b>                                 |   |      |      |        |        |
| +5V Analog Charge Pump                                       | VPPCP, VDDL                             |      | 8    |        | mA     |
| +5V VCO Core and VCO Buffer                                  | fo/1 Mode VCC2                          |      | 105  |        | mA     |
|  | fo/N Mode VCC2                          |      | 80   |        | mA     |
| +5V VCO Divider and RF/PLL Buffer                            | fo/1 Mode VCC1                          |      | 25   |        | mA     |
|  | fo/N Mode VCC1                          | 80   |      | 100    | mA     |
| +3.3V  | AVDD, VCCHF, VCCPS, VCCPD, RVDD, DVDD3V |      | 52   |        | mA     |
| Power Down - Crystal Off                                     | Reg 01h=0, Crystal Not Clocked          |      | 10   |        | μA     |
| Power Down - Crystal On, 100 MHz                             | Reg 01h=0, Crystal Clocked 100 MHz      |      | 10   | 30     | mA     |
| <b>Power on Reset</b>  |   |      |      |        |        |
| Typical Reset Voltage on DVDD                                |   |      | 700  |        | mV     |
| Min DVDD Voltage for No Reset                                |   | 1.5  |      |        | V      |
| Power on Reset Delay   |   |      | 250  |        | μs     |
| <b>VCO Open Loop Phase Noise at fo @ 2 GHz</b>               |   |      |      |        |        |
| 10 kHz Offset  |   |      | -86  |        | dBc/Hz |

[3] Slew rate of greater or equal to 0.5 ns/V is recommended, see [PLL with Integrated RF VCOs Operating Guide](#) for more details. Frequency is guaranteed across process voltage and temperature from -40 °C to 85 °C.

[4] This maximum phase detector frequency can only be achieved if the minimum N value is respected. eg. In the case of fractional feedback mode, the maximum PFD rate =  $f_{vco}/20$  or 100 MHz, whichever is less.

Information furnished by Analog Devices is believed to be accurate and reliable. However, no responsibility is assumed by Analog Devices for its use, nor for any infringements of patents or other rights of third parties that may result from its use. Specifications subject to change without notice. No license is granted by implication or otherwise under any patent or patent rights of Analog Devices. Trademarks and registered trademarks are the property of their respective owners.

For price, delivery, and to place orders: Analog Devices, Inc., One Technology Way, P.O. Box 9106, Norwood, MA 02062-9106  
Phone: 781-329-4700 • Order online at [www.analog.com](http://www.analog.com)  
Application Support: Phone: 1-800-ANALOG-D



**FRACTIONAL-N PLL WITH INTEGRATED VCO**  
**25 - 3000 MHz**
**Electrical Specifications (Continued)**

| Parameter  | Condition          | Min. | Typ. | Max. | Units  |
|--|--------------------|------|------|------|--------|
| 100 kHz Offset   |                    |      | -116 |      | dBc/Hz |
| 1 MHz Offset   |                    |      | -141 |      | dBc/Hz |
| 10 MHz Offset  |                    |      | -162 |      | dBc/Hz |
| 100 MHz Offset   |                    |      | -171 |      | dBc/Hz |
| <b>VCO Open Loop Phase Noise at fo @ 2 GHz/2 = 1 GHz</b>   |                    |      |      |      |        |
| 10 kHz Offset  |                    |      | -92  |      | dBc/Hz |
| 100 kHz Offset   |                    |      | -122 |      | dBc/Hz |
| 1 MHz Offset   |                    |      | -147 |      | dBc/Hz |
| 10 MHz Offset  |                    |      | -165 |      | dBc/Hz |
| 100 MHz Offset   |                    |      | -165 |      | dBc/Hz |
| <b>VCO Open Loop Phase Noise at fo @3 GHz/30 = 100 MHz</b> |                    |      |      |      |        |
| 10 kHz Offset  |                    |      | -112 |      | dBc/Hz |
| 100 kHz Offset   |                    |      | -142 |      | dBc/Hz |
| 1 MHz Offset   |                    |      | -165 |      | dBc/Hz |
| 10 MHz Offset  |                    |      | -168 |      | dBc/Hz |
| 100 MHz Offset   |                    |      | -171 |      | dBc/Hz |
| <b>Figure of Merit</b>                                     |                    |      |      |      |        |
| Floor Integer Mode   | Normalized to 1 Hz |      | -230 |      | dBc/Hz |
| Floor Fractional Mode                                      | Normalized to 1 Hz |      | -227 |      | dBc/Hz |
| Flicker (Both Modes)                                       | Normalized to 1 Hz |      | -268 |      | dBc/Hz |
| <b>VCO Characteristics</b>                                 |                    |      |      |      |        |
| VCO Tuning Sensitivity at 2800 MHz                         | Measured at 2.5 V  |      | 13.3 |      | MHz/V  |
| VCO Tuning Sensitivity at 2400 MHz                         | Measured at 2.5 V  |      | 13.8 |      | MHz/V  |
| VCO Tuning Sensitivity at 2000 MHz                         | Measured at 2.5 V  |      | 13.6 |      | MHz/V  |
| VCO Tuning Sensitivity at 1600 MHz                         | Measured at 2.5 V  |      | 12.1 |      | MHz/V  |
| VCO Supply Pushing   | Measured at 2.5 V  |      | 2    |      | MHz/V  |

**FRACTIONAL-N PLL WITH INTEGRATED VCO  
25 - 3000 MHz**

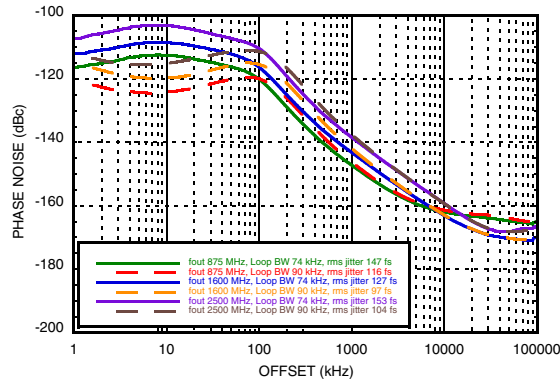

**Figure 1. Typical Closed Loop Integer Phase Noise** ["Loop Filter Configuration Table"]



**Figure 2. Typical Closed Loop Fractional Phase Noise** ["Loop Filter Configuration Table"]

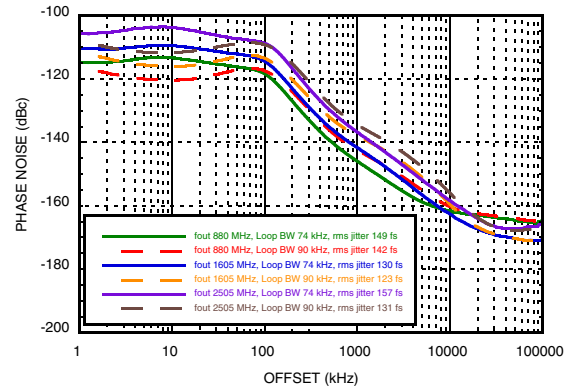

**Figure 3. Free Running Phase Noise**

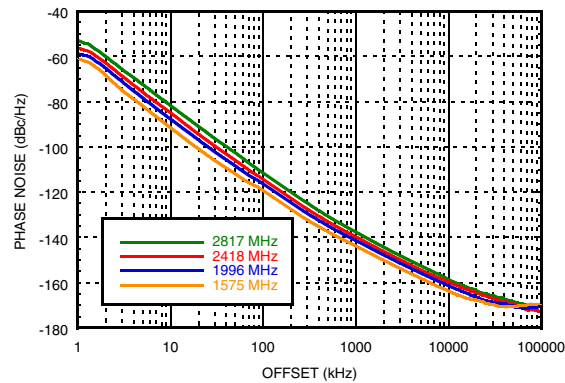

**Figure 4. Free Running VCO Phase Noise vs. Temperature**

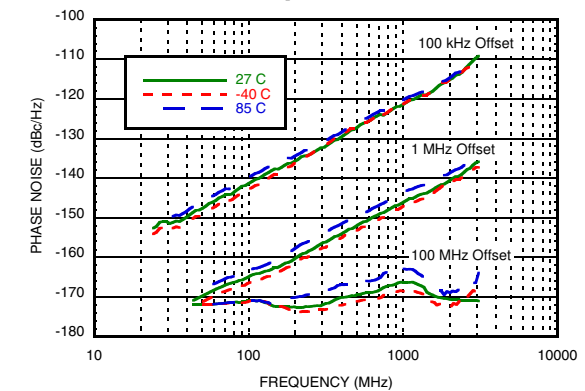

**Figure 5. Typical VCO Sensitivity**

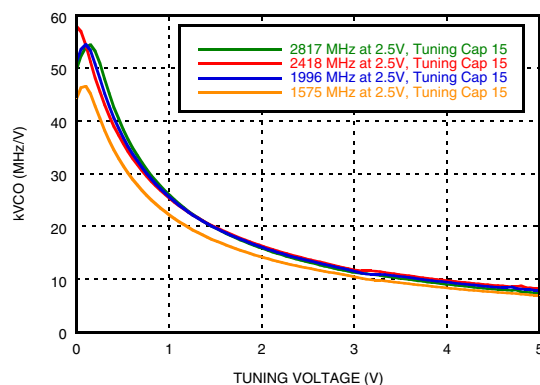

**Figure 6. Typical Tuning Voltage After Calibration**

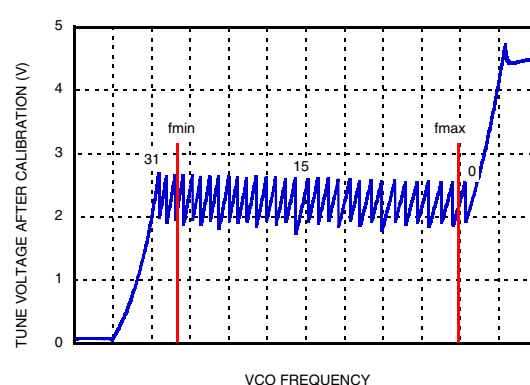

PLLs WITH INTEGRATED VCO - SMT

**FRACTIONAL-N PLL WITH INTEGRATED VCO  
25 - 3000 MHz**



**Figure 7. Integrated RMS Jitter<sup>[1]</sup>**

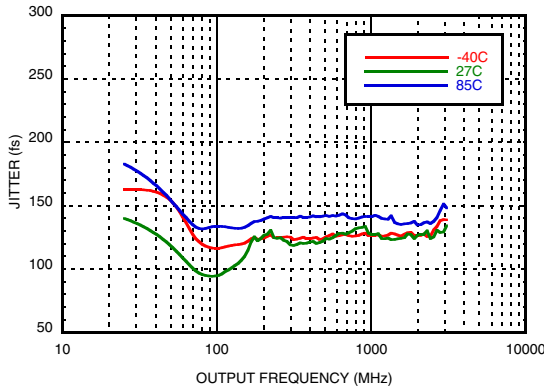

**Figure 8. Figure of Merit**

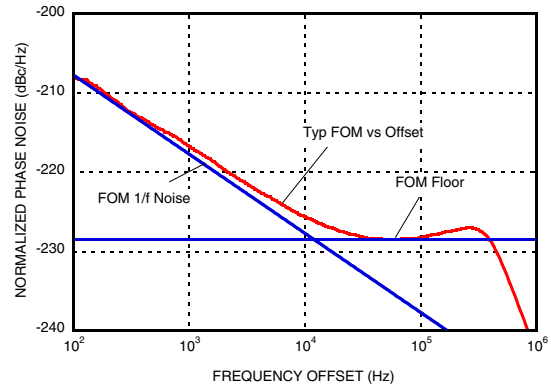

**Figure 9. Typical Output Power**

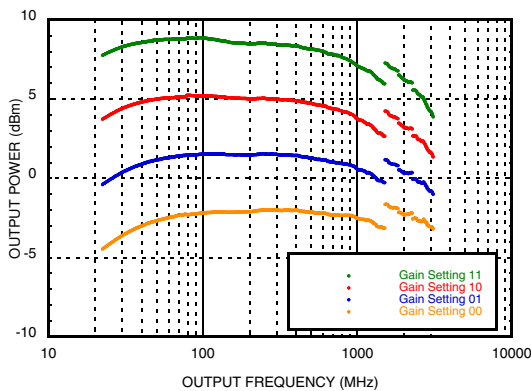

**Figure 10. Typical Output Power vs. Temperature, Maximum Gain**

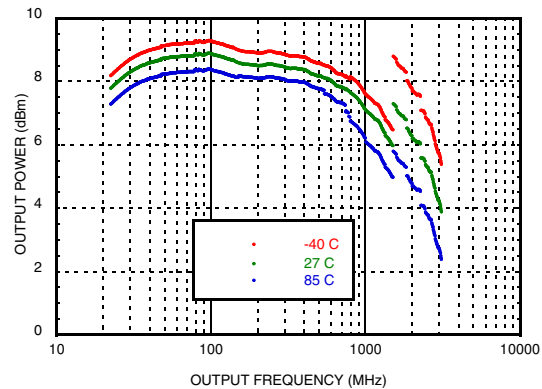

**Figure 11. RF Output Return Loss**

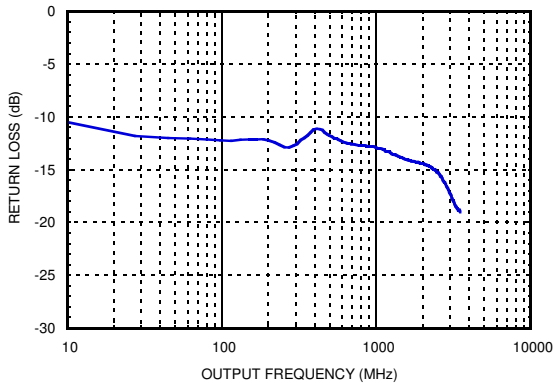

**Figure 12. Reference Input Sensitivity, Square Wave, 50 Ω [2]**

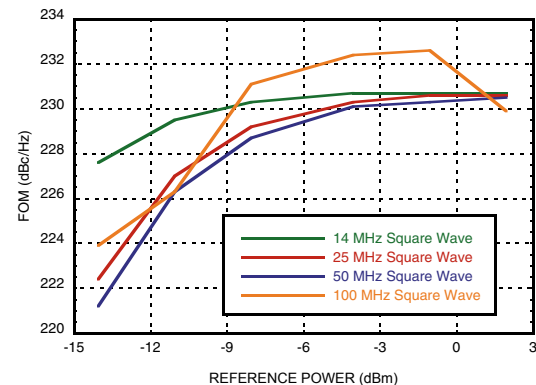

[1] RMS Jitter data is measured in fractional mode with 100 kHz Loop bandwidth using 50 MHz reference frequency from 1 kHz to 20 MHz integration bandwidth.

[2] Measured from a 50 Ω source with a 100 Ω external resistor termination. See [PLL with Integrated RF VCOs Operating Guide](#) Reference Input Stage section for more details. Full FOM performance up to maximum 3.3 Vpp input voltage.



**FRACTIONAL-N PLL WITH INTEGRATED VCO  
25 - 3000 MHz**

**Figure 13. Reference Input Sensitivity  
Sinusoid Wave, 50 Ω<sup>[3]</sup>**

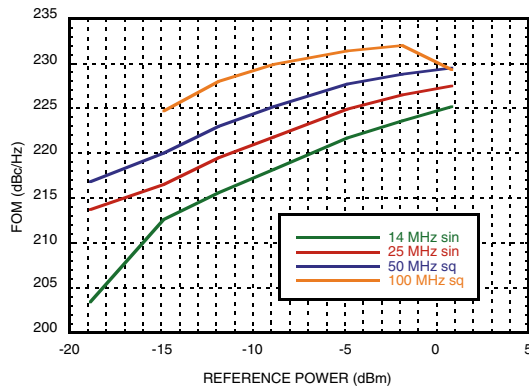

**Figure 14. Integer Boundary Spur at 2500.2 MHz<sup>[4]</sup>**

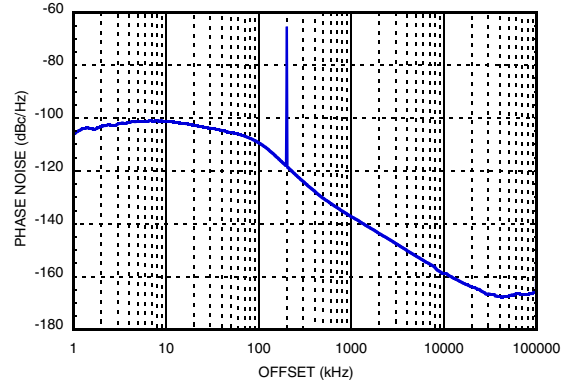

**Figure 15. Integer-N Exact Frequency Mode  
ON Performance at 704 MHz<sup>[5]</sup>**

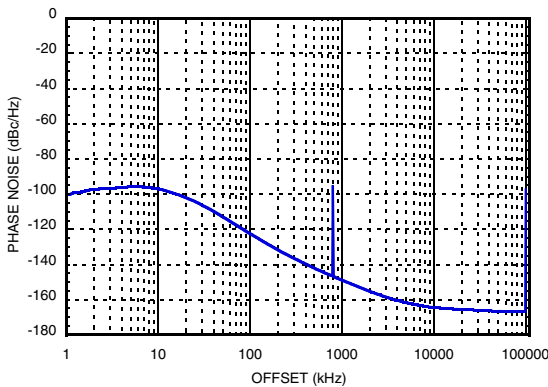

**Figure 16. Fractional-N Exact Frequency  
Mode ON Performance at 2113.5 MHz<sup>[6]</sup>**

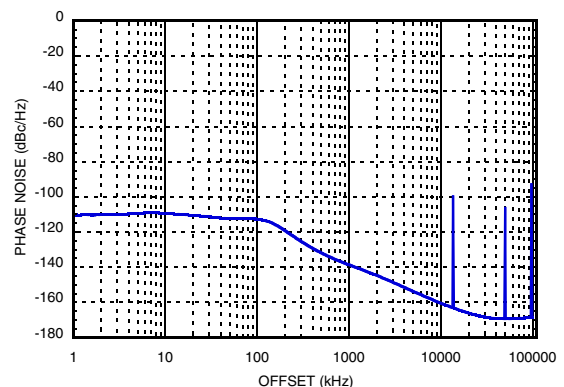

**Figure 17. Fractional-N Exact Frequency  
Mode ON Performance at 2591 MHz<sup>[7]</sup>**

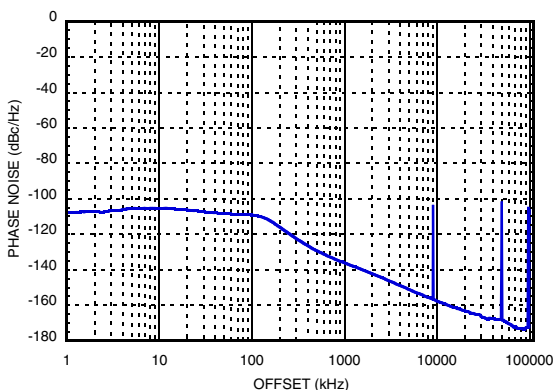

**Figure 18. Fractional-N Exact Frequency  
Mode OFF Performance at 2591 MHz<sup>[8]</sup>**

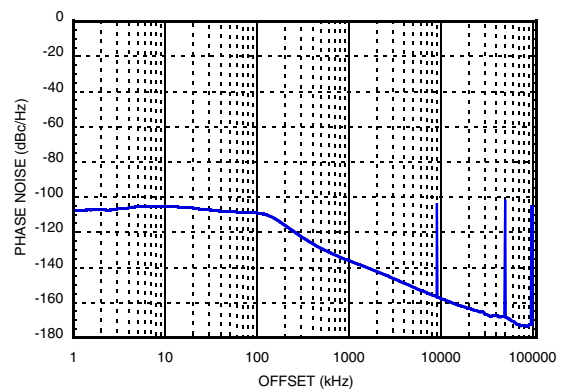

[3] Measured from a 50 Ω source with a 100 Ω external resistor termination. See [PLL with Integrated RF VCOs Operating Guide](#) Reference Input Stage section for more details. Full FOM performance up to maximum 3.3 Vpp input voltage.

[4] Fractional Mode in Mode B, Integer Boundary at 2500 MHz

[5] REF in = 100 MHz, PD = 800 kHz, Output Divider 4 Selected, Loop Filter bandwidth = 16 kHz, Channel Spacing 200 kHz

[6] Exact Frequency Mode, REF in = 100 MHz, PD = 50 MHz, Output Divider 1 Selected, Loop Filter bandwidth = 100 kHz, Channel Spacing = 100 kHz

[7] Exact Frequency Mode, Channel Spacing = 100 kHz, Fractional Mode B RF out = 2591 MHz, REF in = 100 MHz, PD frequency = 50 MHz, Output Divider 1 selected, Loop Filter bandwidth = 120 kHz,

[8] Fractional Mode B RF out = 2591 MHz, REF in = 100 MHz, PD frequency = 50 MHz, Output Divider 1 selected, Loop Filter bandwidth = 120 kHz.

**FRACTIONAL-N PLL WITH INTEGRATED VCO  
25 - 3000 MHz**



**Figure 19. Worst Spur, Fixed 50 MHz Reference, Output Freq. = 2000.1 MHz<sup>[9]</sup>**

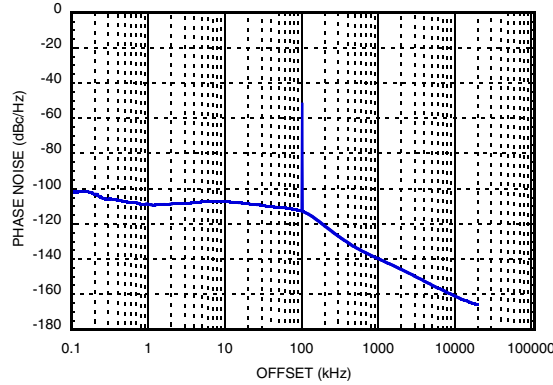

**Figure 20. Worst Spur, Tunable Reference, Output Frequency = 2000.1 MHz<sup>[9]</sup>**

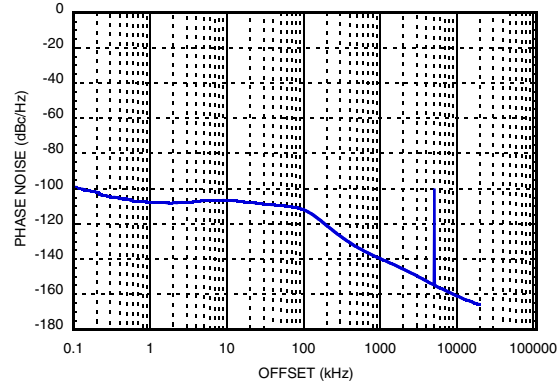

**Figure 21. Worst Spur, Fixed vs. Tunable Reference<sup>[10]</sup>**

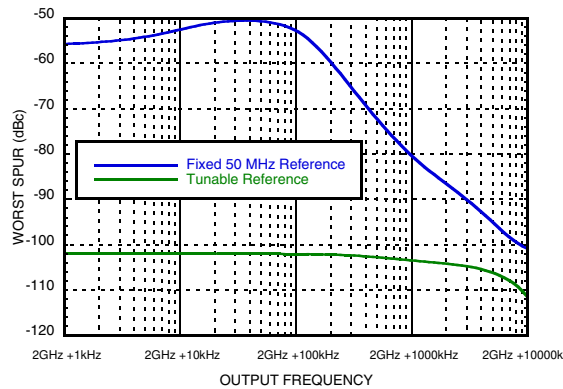

**Figure 22. Low Frequency Performance<sup>[11]</sup>**

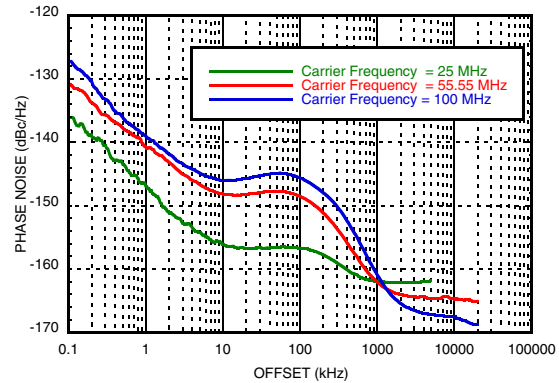

**Loop Filter Configuration Table**

| Loop Filter BW (kHz) | C1 (pF) | C2 (nF) | C3 (pF) | C4 (pF) | R2 (kΩ) | R3 (kΩ) | R4 (kΩ) | Loop Filter Design |
|----------------------|---------|---------|---------|---------|---------|---------|---------|--------------------|
| 74                   | 150     | 27      | 220     | 220     | 0.82    | 1       | 1       |                    |
| 90                   | 270     | 3.9     | 56      | 56      | 1.2     | 1       | 1       |                    |

[9] Capability of HMC830LP6GE to generate low frequencies (as low as 25 MHz), enables the HMC830LP6GE to be used as a tunable reference source into another HMC830LP6GE, which maximizes spur performance of the second HMC830LP6GE. Please see [“HMC830LP6GE Application Information”](#) for more information.

[10] The graph is generated by observing, and plotting, the magnitude of only the worst spur (largest magnitude), at any offset, at each output frequency, while using a fixed 50 MHz reference and a tunable reference tuned to 47.5 MHz. See [“HMC830LP6GE Application Information”](#) for more details.

[11] Phase noise performance of the HMC830LP6GE when used as a tunable reference source. HMC830LP6GE is operating at 3 GHz/30, 3 GHz/54, and 1.55 GHz/62 for the 100 MHz, 55.55 MHz, and 25 MHz curves respectively. 25 MHz output is 50 MHz low pass filtered prior to input to second PLL. 100 MHz and 55.55 MHz curves were not filtered.



**FRACTIONAL-N PLL WITH INTEGRATED VCO  
25 - 3000 MHz**
**Pin Descriptions**

| Pin Number  | Function | Description  |
|---|----------|--|
| 1   | AVDD     | DC Power Supply for analog circuitry.  |
| 2, 5, 6, 8, 9,<br>11 - 14, 18 - 22, 24,<br>26, 34, 37, 38 | N/C      | The pins are not connected internally; however, all data shown herein was measured with these pins connected to RF/DC ground externally.   |
| 3   | VPPCP    | Power Supply for charge pump analog section  |
| 4   | CP       | Charge Pump Output   |
| 7   | VDDL5    | Power Supply for the charge pump digital section   |
| 10  | RVDD     | Reference Supply   |
| 15  | XREFP    | Reference Oscillator Input   |
| 16  | DVDD3V   | DC Power Supply for Digital (CMOS) Circuitry   |
| 17  | CEN      | Chip Enable. Connect to logic high for normal operation.   |
| 23  | VTUNE    | VCO Varactor. Tuning Port Input.   |
| 25  | VCC2     | VCO Analog Supply 2  |
| 27  | VCC1     | VCO Analog Supply 1  |
| 28  | RF_N     | RF Negative Output<br>(On in differential configuration, On in single-ended configuration)   |
| 29  | RF_P     | RF Positive Output<br>(On in differential configuration, Off in single-ended configuration)  |
| 30  | SEN      | PLL Serial Port Enable (CMOS) Logic Input  |
| 31  | SDI      | PLL Serial Port Data (CMOS) Logic Input  |
| 32  | SCK      | PLL Serial Port Clock (CMOS) Logic Input   |
| 33  | LD_SDO   | Lock Detect, or Serial Data, or General Purpose (CMOS) Logic Output (GPO)  |
| 35  | VCCHF    | DC Power Supply for Analog Circuitry   |
| 36  | VCCPS    | DC Power Supply for Analog Prescaler   |
| 39  | VCCPD    | DC Power Supply for Phase Detector   |
| 40  | BIAS     | External bypass decoupling for precision bias circuits.<br>Note: 1.920V $\pm$ 20mV reference voltage (BIAS) is generated internally and cannot drive an external load. Must be measured with 10G $\Omega$ meter such as Agilent 34410A, normal 10M $\Omega$ DVM will read erroneously. |

**FRACTIONAL-N PLL WITH INTEGRATED VCO  
25 - 3000 MHz**
**Absolute Maximum Ratings**

|  |                  |
|--|------------------|
| AVDD, RVDD, DVDD3V, VCCPD, VCCHF, VCCPS                                    | -0.3 V to +3.6 V |
| VPPCP, VDDL5, VCC1   | -0.3 V to +5.5 V |
| VCC2   | -0.3 V to +5.5 V |
| Operating Temperature  | -40 °C to +85 °C |
| Storage Temperature  | -65 °C to 150 °C |
| Maximum Junction Temperature   | 150 °C           |
| Thermal Resistance ( $\Theta_{JC}$ )<br>(junction to case (ground paddle)) | 9 °C/W           |
| Reflow Soldering   |                  |
| Peak Temperature   | 260 °C           |
| Time at Peak Temperature   | 40 sec           |
| ESD Sensitivity (HBM)  | Class 1B         |

Stresses above those listed under Absolute Maximum Ratings may cause permanent damage to the device. This is a stress rating only; functional operation of the device at these or any other conditions above those indicated in the operational section of this specification is not implied. Exposure to absolute maximum rating conditions for extended periods may affect device reliability.

**Recommended Operating Conditions**

| Parameter                               | Condition | Min. | Typ. | Max. | Units |
|---|-----------|------|------|------|-------|
| <b>Temperature</b>                      |           |      |      |      |       |
| Junction Temperature                    |           |      |      | 125  | °C    |
| Ambient Temperature                     |           | -40  |      | 85   | °C    |
| <b>Supply Voltage</b>                   |           |      |      |      |       |
| AVDD, RVDD, DVDD3V, VCCPD, VCCHF, VCCPS |           | 3.0  | 3.3  | 3.5  | V     |
| VPPCP, VDDL5, VCC1, VCC2                |           | 4.8  | 5    | 5.2  | V     |

[1] Layout design guidelines set out in [Qualification Test Report](#) are strongly recommended.

## FRACTIONAL-N PLL WITH INTEGRATED VCO 25 - 3000 MHz



### Outline Drawing

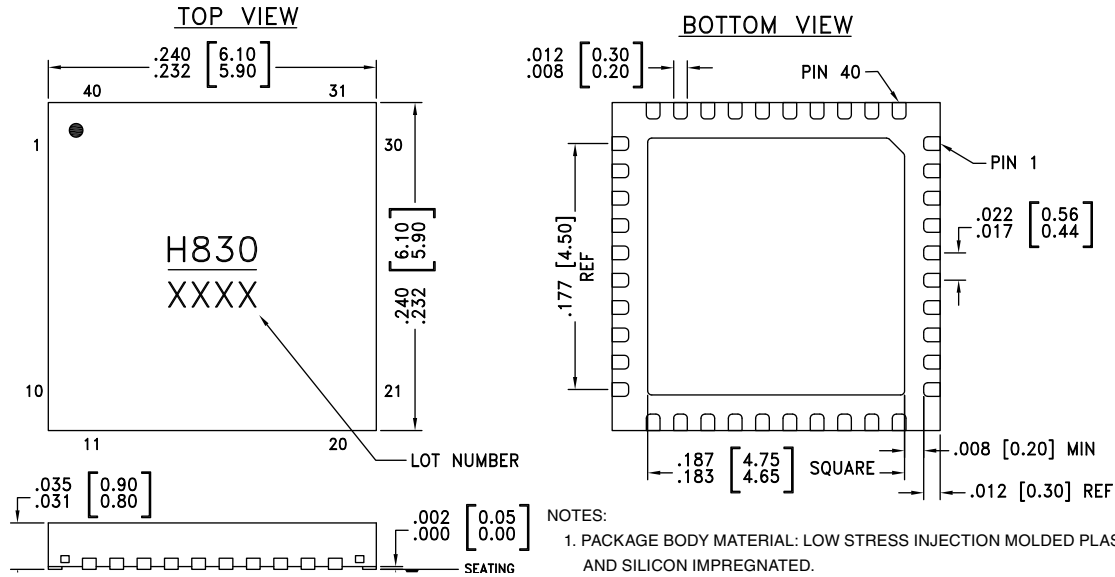

### Package Information

| Part Number | Package Body Material                              | Lead Finish   | MSL Rating | Package Marking <sup>[1]</sup> |
|-------------|--|---------------|------------|--------------------------------|
| HMC830LP6GE | RoHS-compliant Low Stress Injection Molded Plastic | 100% matte Sn | MSL1       | H830<br>XXXX                   |

[1] 4-Digit lot number XXXX

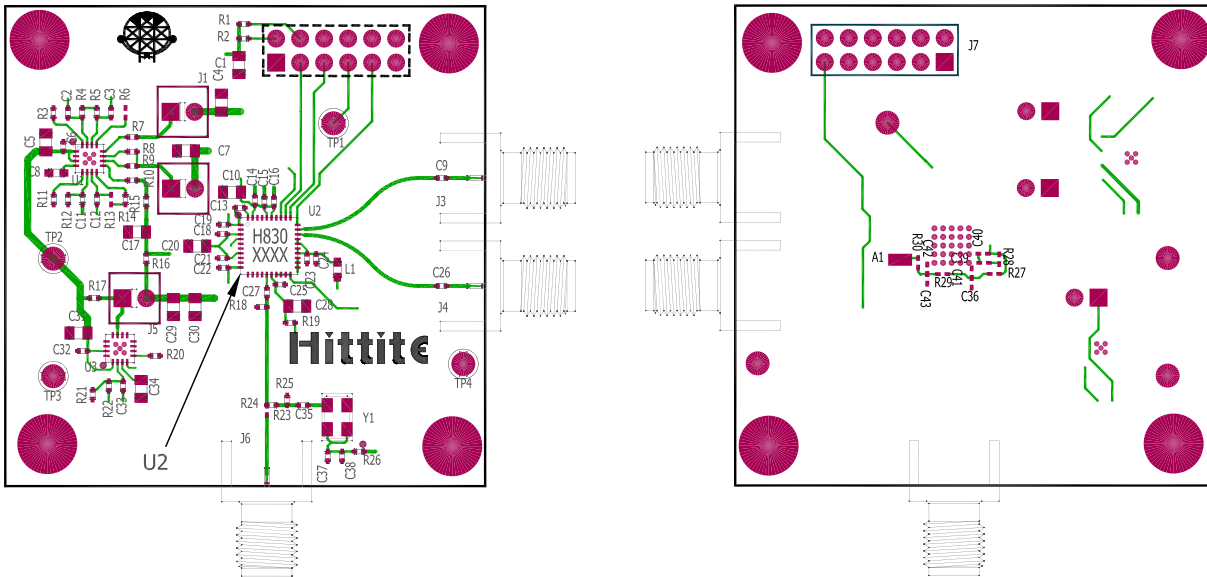
**Evaluation PCB**

The circuit board used in the application should use RF circuit design techniques. Signal lines should have 50 Ohm impedance while the package ground leads and exposed paddle should be connected directly to the ground plane similar to that shown. A sufficient number of via holes should be used to connect the top and bottom ground planes. The evaluation circuit board shown is available from Hittite upon request.

**Evaluation PCB Schematic**

To view this [Evaluation PCB Schematic](#) please visit [www.hittite.com](http://www.hittite.com) and choose HMC830LP6GE from the "Search by Part Number" pull down menu to view the product splash page.

**Evaluation Order Information**

| Item                | Contents  | Part Number        |
|---------------------|---|--------------------|
| Evaluation PCB Only | HMC830LP6GE Evaluation PCB  | EVAL01-HMC830LP6GE |
| Evaluation Kit      | HMC830LP6GE Evaluation PCB<br>USB Interface Board<br>6' USB A Male to USB B Female Cable<br>CD ROM (Contains User Manual, Evaluation PCB Schematic, Evaluation Software, Hittite PLL Design Software) | EKIT01-HMC830LP6GE |



**FRACTIONAL-N PLL WITH INTEGRATED VCO**  
**25 - 3000 MHz**

**HMC830LP6GE Application Information**

Large bandwidth (25 MHz to 3000 MHz), industry leading phase noise and spurious performance, excellent noise floor (<-170 dBc/Hz), coupled with a high level of integration make the HMC830LP6GE ideal for a variety of applications; as an RF or IF stage LO, a clock source for high-frequency data-converters, or a tunable reference source for extremely low spurious applications (< -100 dBc/Hz spurs).

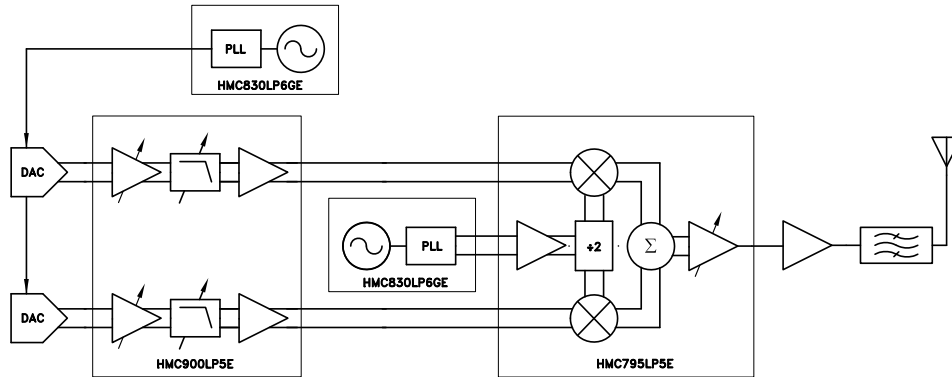

Figure 23. HMC830LP6GE in a typical transmit chain

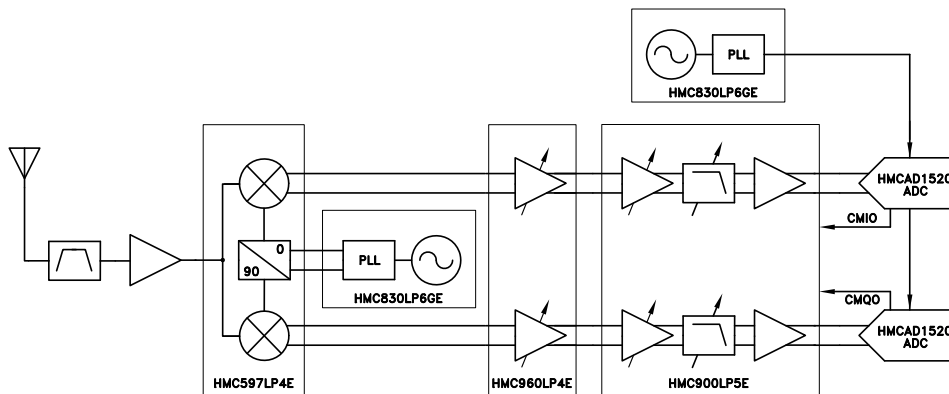

Figure 24. HMC830LP6GE in a typical receive chain

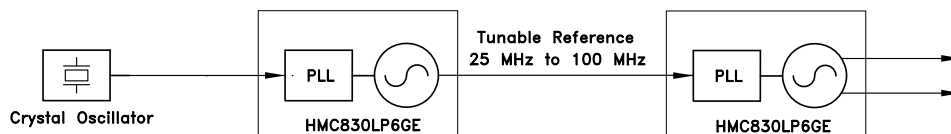

Figure 25. HMC830LP6GE used as a tunable reference for second HMC830LP6GE

Using the HMC830LP6GE with a tunable reference as shown in [Figure 25](#), it is possible to drastically improve spurious emissions performance across all frequencies. Example shown in [Figure 21](#) graph shows that it is possible to have spurious emissions < -100 dBc/Hz across all frequencies. For more information about spurious emissions, how they are related to the reference frequency, and how to tune the reference frequency for optimal spurious performance please see the “Spurious Performance” section of [Hittite PLL w/ Integrated VCOs Operating Guide](#). Note that at very low output frequencies < 100 MHz, harmonics increase due to small internal AC coupling. Applications which are sensitive to harmonics may require external low pass filtering.

Information furnished by Analog Devices is believed to be accurate and reliable. However, no responsibility is assumed by Analog Devices for its use, nor for any infringements of patents or other rights of third parties that may result from its use. Specifications subject to change without notice. No license is granted by implication or otherwise under any patent or patent rights of Analog Devices. Trademarks and registered trademarks are the property of their respective owners.

For price, delivery, and to place orders: Analog Devices, Inc., One Technology Way, P.O. Box 9106, Norwood, MA 02062-9106 Phone: 781-329-4700 • Order online at [www.analog.com](http://www.analog.com) Application Support: Phone: 1-800-ANALOG-D

**FRACTIONAL-N PLL WITH INTEGRATED VCO  
25 - 3000 MHz****Notes:**

## X-ON Electronics

Largest Supplier of Electrical and Electronic Components

*Click to view similar products for [Phase Locked Loops - PLL category](#):*

*Click to view products by [Analog Devices manufacturer](#):*

Other Similar products are found below :

[CPLL58-2400-2500](#) [MB15E07SLPFV1-G-BND-6E1](#) [PI6C2409-1HWEX](#) [BA4116FV-E2](#) [HMC764LP6CETR](#) [HMC820LP6CETR](#)  
[CY22050KFI](#) [LMX2430TMX/NOPB](#) [NB3N5573DTG](#) [ADF4153ABCPZ](#) [PI6C2405A-1LE](#) [CD74HC4046AM](#) [CPLL66-2450-2450](#)  
[NJM567D](#) [74HC4046ADB.112](#) [74HC4046APW.112](#) [CY23S05SXI-1](#) [STW81200T](#) [ADF4208BRUZ](#) [ADF4218LBRUZ](#) [ADF4355-3BCPZ](#)  
[ADF4355BCPZ](#) [ADF4169WCCPZ](#) [ADF4360-6BCPZ](#) [ADF4360-5BCPZRL7](#) [ADF4360-5BCPZ](#) [ADF4360-4BCPZRL7](#) [ADF4360-4BCPZ](#)  
[ADF4360-3BCPZ](#) [ADF4360-2BCPZRL7](#) [ADF4252BCPZ](#) [ADF4159CCPZ](#) [ADF4169CCPZ](#) [ADF4360-0BCPZ](#) [ADF4360-1BCPZ](#) [ADF4360-1BCPZRL7](#) [ADF4360-2BCPZ](#) [ADF4360-3BCPZRL7](#) [ADF4360-7BCPZRL7](#) [ADF4360-8BCPZ](#) [ADF4360-8BCPZRL7](#) [ADF4360-9BCPZ](#)  
[ADF4360-9BCPZRL7](#) [ADF4159CCPZ-RL7](#) [ADF4159WCCPZ](#) [ADF4360-0BCPZRL7](#) [AD9901KPZ](#) [AD9901KQ](#) [ADF4001BCPZ](#)  
[ADF4002BCPZ-RL7](#)