

FRACTIONAL-N PLL WITH INTEGRATED VCO, 3365 - 3705 MHz



Features

- RF Bandwidth: 3365 to 3705 MHz
- Ultra Low Phase Noise
-98 dBc/Hz in Band Typ
- Figure of Merit (FOM) -227 dBc
- < 180 fs rms Jitter
(Integrated 100 Hz to 100 MHz SSB)
- 24-bit Frequency Step Size,
Resolution 3 Hz typ
- Exact Frequency Mode
- Built-in Digital Self Test
- 40 Lead 6x6 mm SMT Package: 36 mm²

Typical Applications

- Cellular/4G Infrastructure
- Repeaters and Femtocells
- Communications Test Equipment
- CATV Equipment
- Phased Array Applications
- DDS Replacement
- Very High Data Rate Radios

Functional Diagram

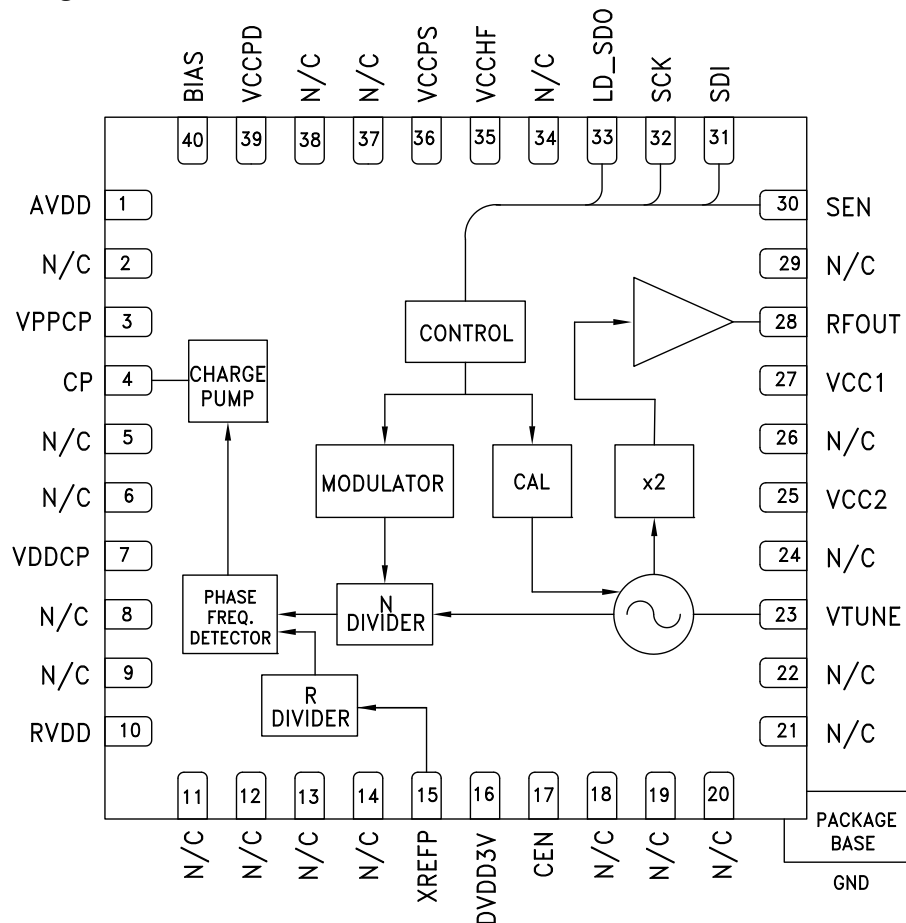

Information furnished by Analog Devices is believed to be accurate and reliable. However, no responsibility is assumed by Analog Devices for its use, nor for any infringements of patents or other rights of third parties that may result from its use. Specifications subject to change without notice. No license is granted by implication or otherwise under any patent or patent rights of Analog Devices. Trademarks and registered trademarks are the property of their respective owners.

For price, delivery, and to place orders: Analog Devices, Inc., One Technology Way, P.O. Box 9106, Norwood, MA 02062-9106 Phone: 781-329-4700 • Order online at www.analog.com Application Support: Phone: 1-800-ANALOG-D



FRACTIONAL-N PLL WITH INTEGRATED VCO, 3365 - 3705 MHz

General Description

The HMC836LP6CE is a fully functional Fractional-N Phase-Locked-Loop (PLL) with an Integrated Voltage Controlled Oscillator (VCO). The PLL consists of an integrated low noise VCO with x2 output, an autocalibration subsystem for low voltage VCO tuning, a very low noise digital Phase Detector (PD), a precision controlled charge pump, a low noise reference path divider and a fractional divider.

The fractional PLL features an advanced delta-sigma modulator design that allows both fine step sizes and low spurious products. The phase detector (PD) features cycle slip prevention (CSP) technology to allow faster frequency hopping times. Ultra low in-close phase noise and low spurious also allows wider loop bandwidths for faster frequency hopping and low micro-phonics.

For theory of operation and register map refer to the “PLLs with Integrated VCOs - RF VCOs Operating Guide”. To view the Operating Guide, please visit www.hittite.com and choose HMC836LP6CE from the “Search by Part Number” pull down menu.

Electrical Specifications, $T_A = +25^\circ\text{C}$

VPPCP, VDDCP, VCC1, VCC2 = 5V ±4%; RVDD, AVDD, DVDD3V, VCCPD, VCCHF, VCCPS = 3.3V ±6% GNDCP = GNDLS = Ground Paddle = 0V

| Parameter | Condition | Min. | Typ. | Max. | Units |
|--|--|--------|------|---------|-------|
| RF Output Characteristics | | | | | |
| VCO Frequency | | 1682.5 | | 1852.5 | MHz |
| RF Output Frequency at $f_{VCO} \times 2$ | | 3365 | | 3705 | MHz |
| RF Output Power at $f_{VCO} \times 2$ | | -1 | 6 | 9 | dBm |
| VCO Tuning Sensitivity | Measured at 2 GHz, 2V | | 15 | | MHz/V |
| VCO Supply Pushing | Measured at 2 GHz, 2V | -2 | | 1.5 | MHz/V |
| RF Output 2nd Harmonic | | | -25 | | dBc |
| RF Output 3rd Harmonic | | | -23 | | dBc |
| RF Output 4th Harmonic | | | -31 | | dBc |
| RF Divider Characteristics | | | | | |
| 19-Bit N-Divider Range (Integer) | Max = $2^{19} - 1$ | 16 | | 524,287 | |
| 19-Bit N-Divider Range (Fractional) | Fractional nominal divide ratio varies (-3 / +4) dynamically max | 20 | | 524,283 | |
| REF Input Characteristics | | | | | |
| Ref Input Frequency | Synthesizer phase noise can degrade by about 5dB when operating with a reference frequency near the low end of this range. | 10 | 50 | 200 | MHz |
| Ref Input Range | AC Coupled | 1.5 | 2 | 3.3 | Vpp |
| Ref Input Capacitance | | | | 5 | pF |
| 14-Bit R-Divider Range | | 1 | | 16,383 | |
| Phase Detector (PD) | | | | | |
| PD Frequency Fractional Feedback Mode | [1] | 0.1 | | 100 | MHz |
| PD Frequency Fractional Feedforward Mode (and Register 6 [17:16] = 10) | [1] | 0.1 | | 80 | MHz |
| PD Frequency Integer Mode | [1] | 0.1 | | 125 | MHz |

Note 1: This maximum phase detector frequency can only be achieved if the minimum N value is respected. eg. In the case of fractional feedback mode, the maximum PFD rate = $f_{vco}/20$ or 100MHz, whichever is less.



FRACTIONAL-N PLL WITH INTEGRATED VCO, 3365 - 3705 MHz

Electrical Specifications (Continued)

| Parameter | Condition | Min. | Typ. | Max. | Units |
|--|------------------------------------|------------|------|--------|---------|
| Charge Pump | | | | | |
| Output Current | | 0.02 | | 2.54 | mA |
| Charge Pump Gain Step Size (5-Bits) | | | 20 | | μ A |
| PD/Charge Pump SSB Phase Noise | 50 MHz Ref, Input Referred, | | | | |
| 1 kHz | | | -141 | | dBc/Hz |
| 10 kHz | add 1 dB for fractional | | -149 | | dBc/Hz |
| 100 kHz | add 3 dB for fractional | | -153 | | dBc/Hz |
| Logic Inputs | | | | | |
| VIH Input High Voltage | | DVDD3V-0.4 | | DVDD3V | V |
| VIL Input Low Voltage | | 0 | | 0.4 | V |
| Logic Outputs | | | | | |
| VOH Output High Voltage | | DVDD3V-0.4 | | DVDD3V | V |
| VOL Output Low Voltage | | 0 | | 0.4 | V |
| Power Supply Voltages | | | | | |
| Analog 3.3V Supplies | AVDD, VCCHF, VCCPS, VCCPD, RVDD | 3.0 | 3.3 | 3.5 | V |
| Digital Supply | DVDD3V | 3.0 | 3.3 | 3.5 | V |
| Analog 5V Supplies | VPPCP, VDDCP, VCC1, VCC2 | 4.8 | 5 | 5.2 | V |
| Power Supply Currents | | | | | |
| +5V Analog Charge Pump | VPPCP, VDDCP | | 5.3 | | mA |
| +5V VCO Core and PLL Buffer | VCC2 | | 56 | | mA |
| +5V VCO RF Buffer | VCC1 | | 36 | | mA |
| +3.3V Analog | AVDD, VCCHF, VCCPS, VCCPD, RVDD | | 45 | | mA |
| +3.3V Digital | DVDD3V | | 6.5 | | mA |
| Power Down - Crystal Off | Reg 01h=0, Crystal Not Clocked | | 10 | | μ A |
| Power Down - Crystal On, 100 MHz | Reg 01h=0, Crystal Clocked 100 MHz | | 10 | 200 | μ A |
| Power on Reset | | | | | |
| Typical Reset Voltage on DVDD | | | 700 | | mV |
| DVDD Voltage for No Reset | | 1.5 | | | V |
| Power on Reset Delay | | | 250 | | μ s |
| VCO Open Loop SSB Phase Noise at fo = 1.75 GHz | | | | | |
| 10 kHz Offset | | | -91 | | dBc/Hz |
| 100 kHz Offset | | | -111 | | dBc/Hz |
| 1 MHz Offset | | | -136 | | dBc/Hz |
| 10 MHz Offset | | | -157 | | dBc/Hz |
| 100 MHz Offset | | | -169 | | dBc/Hz |
| Closed Loop Phase Noise PLL + VCO at fo = 3.5 GHz | | | | | |
| Integer, 50 MHz PFD | 1 kHz Offset | | -102 | | dBc/Hz |
| Integer, 50 MHz PFD | 10 kHz Offset | | -107 | | dBc/Hz |
| Integer, 50 MHz PFD | 100 kHz Offset | | -107 | | dBc/Hz |



FRACTIONAL-N PLL WITH INTEGRATED VCO, 3365 - 3705 MHz

Electrical Specifications (Continued)

| Parameter | Condition | Min. | Typ. | Max. | Units |
|------------------------|--|------|------|------|--------|
| Fractional, 50 MHz PFD | 1 kHz Offset | | -197 | | dBc/Hz |
| Fractional, 50 MHz PFD | 10 kHz Offset | | -102 | | dBc/Hz |
| Fractional, 50 MHz PFD | 100 kHz Offset | | -102 | | dBc/Hz |
| Figure of Merit | Normalized 1 Hz | | | | |
| Integer Mode | Measured w/ 50 MHz PD at 30 kHz Offset | | -229 | | dBc/Hz |
| Fractional Mode | Measured w/ 50 MHz PD at 30 kHz Offset | | -227 | | dBc/Hz |

Closed Loop Integer Mode, SSB Phase Noise

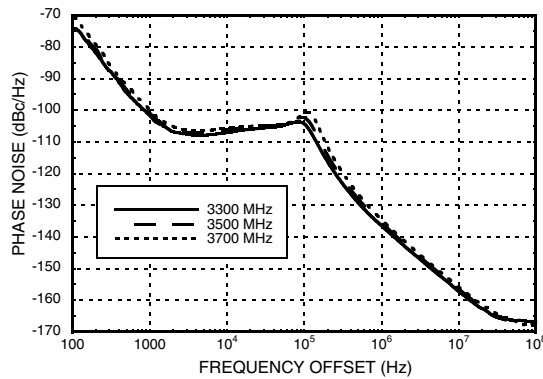

Typical Closed Loop Fractional Mode, SSB Phase Noise [1]

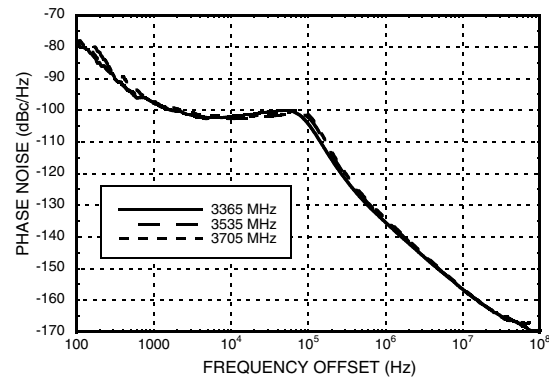

VCO Free Running SSB Phase Noise

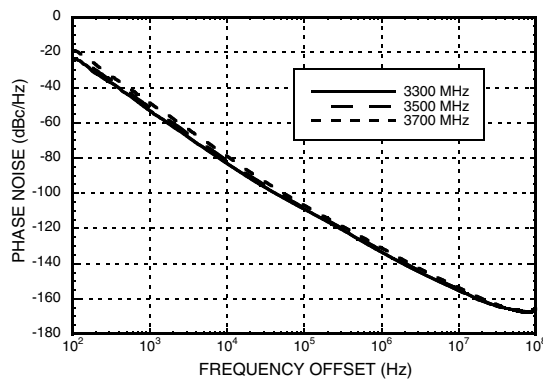

Typical Tuning Curves vs. Switch Position

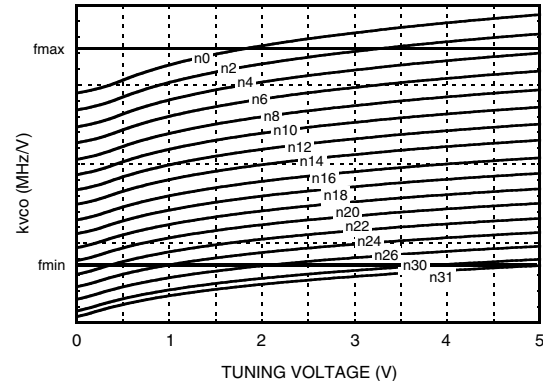

[1] Fractional Mode, 50 MHz Crystal, R=1, ~80 kHz Loop BW, (Loop filter values: Contact factory for component values) 2mA Charge Pump, -385µA Offset.

Information furnished by Analog Devices is believed to be accurate and reliable. However, no responsibility is assumed by Analog Devices for its use, nor for any infringements of patents or other rights of third parties that may result from its use. Specifications subject to change without notice. No license is granted by implication or otherwise under any patent or patent rights of Analog Devices. Trademarks and registered trademarks are the property of their respective owners.

For price, delivery, and to place orders: Analog Devices, Inc., One Technology Way, P.O. Box 9106, Norwood, MA 02062-9106 Phone: 781-329-4700 • Order online at www.analog.com Application Support: Phone: 1-800-ANALOG-D



FRACTIONAL-N PLL WITH INTEGRATED VCO, 3365 - 3705 MHz

Typical VCO Tuning Voltage After Calibration vs. VCO Frequency & CAP Setting [2]

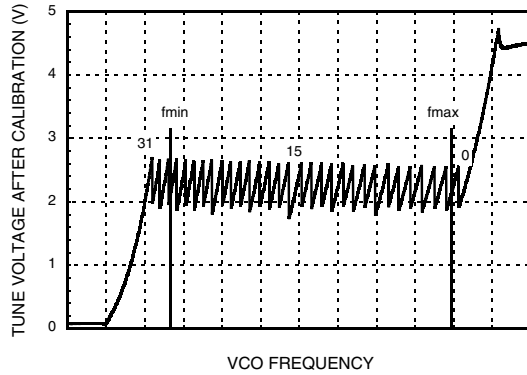

Typical VCO Sensitivity vs. VCO Tune Voltage & CAP Setting @ fo [2]

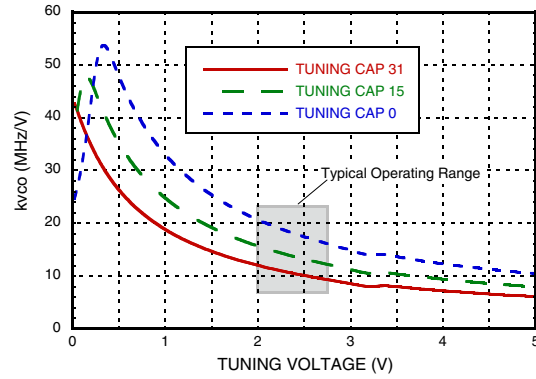

Typical Output Power

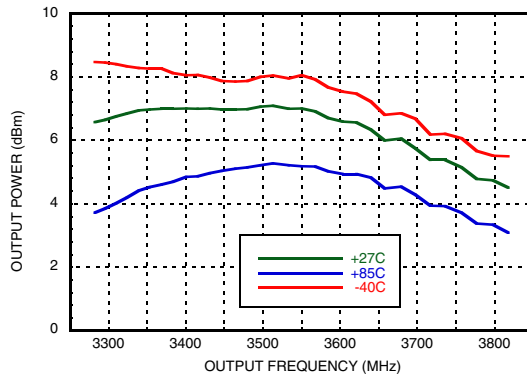
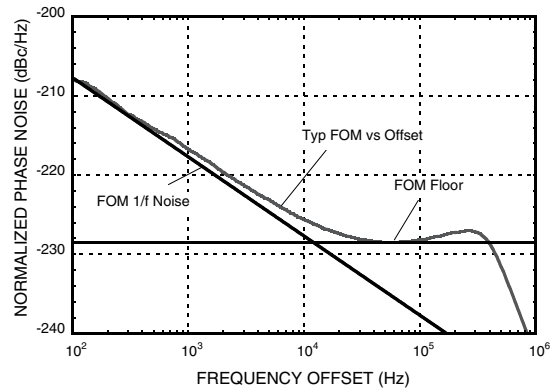

Figure of Merit



7

PLLS w/ INTEGRATED VCO - SMT

[1] Fractional Mode, 50 MHz Crystal, R=1, ~80 kHz Loop BW, (Loop filter values: Contact factory for component values) 2mA Charge Pump, -385µA Offset.

[2] The CAP setting is the digitally selectable VCO tank capacitor setting. This feature allows the nominal center frequency of the VCO to be adjusted by switching in/out VCO tank capacitors.

Information furnished by Analog Devices is believed to be accurate and reliable. However, no responsibility is assumed by Analog Devices for its use, nor for any infringements of patents or other rights of third parties that may result from its use. Specifications subject to change without notice. No license is granted by implication or otherwise under any patent or patent rights of Analog Devices. Trademarks and registered trademarks are the property of their respective owners.

For price, delivery, and to place orders: Analog Devices, Inc., One Technology Way, P.O. Box 9106, Norwood, MA 02062-9106 Phone: 781-329-4700 • Order online at www.analog.com Application Support: Phone: 1-800-ANALOG-D

**FRACTIONAL-N PLL WITH
INTEGRATED VCO, 3365 - 3705 MHz**
Pin Descriptions

| Pin Number | Function | Description |
|---|----------|--|
| 1 | AVDD | DC Power Supply for analog circuitry. |
| 2, 5, 6, 8, 9, 11 - 14, 18 - 22, 24, 26, 29, 34, 37, 38 | N/C | The pins are not connected internally; however, all data shown herein was measured with these pins connected to RF/DC ground externally. |
| 3 | VPPCP | Power Supply for charge pump analog section |
| 4 | CP | Charge Pump Output |
| 7 | VDDCP | Power Supply for the charge pump digital section |
| 10 | RVDD | Reference Supply |
| 15 | XREFP | Reference Oscillator Input |
| 16 | DVDD3V | DC Power Supply for Digital (CMOS) Circuitry |
| 17 | CEN | Chip Enable. Connect to logic high for normal operation. |
| 23 | VTUNE | VCO Varactor. Tuning Port Input. |
| 25 | VCC2 | VCO Analog Supply 2 |
| 27 | VCC1 | VCO Analog Supply 1 |
| 28 | RFOUT | RF Doubler Output |
| 30 | SEN | PLL Serial Port Enable (CMOS) Logic Input |
| 31 | SDI | PLL Serial Port Data (CMOS) Logic Input |
| 32 | SCK | PLL Serial Port Clock (CMOS) Logic Input |
| 33 | LD_SDO | Lock Detect, or Serial Data, or General Purpose (CMOS) Logic Output (GPO) |
| 35 | VCCHF | DC Power Supply for Analog Circuitry |
| 36 | VCCPS | DC Power Supply for Analog Prescaler |
| 39 | VCCPD | DC Power Supply for Phase Detector |
| 40 | BIAS | External bypass decoupling for precision bias circuits. Note: 1.920V \pm 20mV reference voltage (BIAS) is generated internally and cannot drive an external load. Must be measured with 10G Ω meter such as Agilent 34410A, normal 10M Ω DVM will read erroneously. |



FRACTIONAL-N PLL WITH INTEGRATED VCO, 3365 - 3705 MHz

Absolute Maximum Ratings

| | |
|---|----------------|
| AVDD, RVDD, DVDD3V, VCCPD, VCCHF, VCCPS | -0.3V to +3.6V |
| VPPCP, VDDCP, VCC1 | -0.3V to +5.8V |
| VCC2 | -0.3V to +5.5V |
| Operating Temperature | -40°C to +85°C |
| Storage Temperature | -65°C to 125°C |
| Maximum Junction Temperature | 125 °C |
| Thermal Resistance (R _{TH}) (junction to ground paddle) | 20 °C/W |
| Reflow Soldering | |
| Peak Temperature | 260°C |
| Time at Peak Temperature | 40 sec |
| ESD Sensitivity (HBM) | Class 1B |

Stresses above those listed under Absolute Maximum Ratings may cause permanent damage to the device. This is a stress rating only; functional operation of the device at these or any other conditions above those indicated in the operational section of this specification is not implied. Exposure to absolute maximum rating conditions for extended periods may affect device reliability.

Outline Drawing

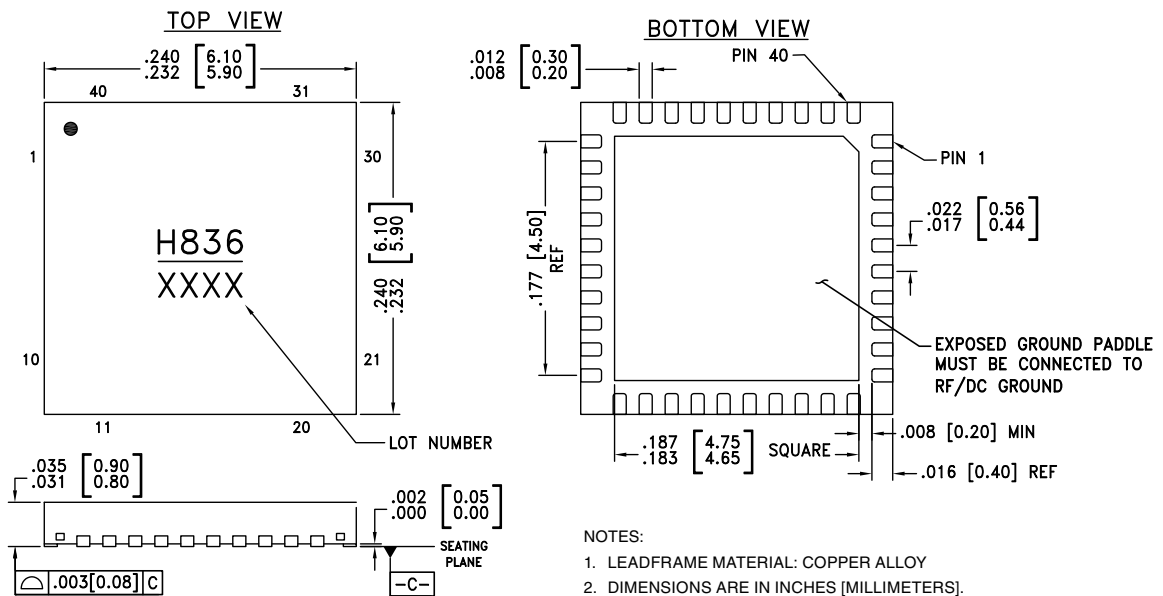

Package Information

| Part Number | Package Body Material | Lead Finish | MSL Rating | Package Marking ^[1] |
|-------------|--|---------------|------------|--------------------------------|
| HMC836LP6CE | RoHS-compliant Low Stress Injection Molded Plastic | 100% matte Sn | MSL1 | H836 XXXX |

[1] 4-Digit lot number XXXX



**FRACTIONAL-N PLL WITH
INTEGRATED VCO, 3365 - 3705 MHz**

Evaluation PCB

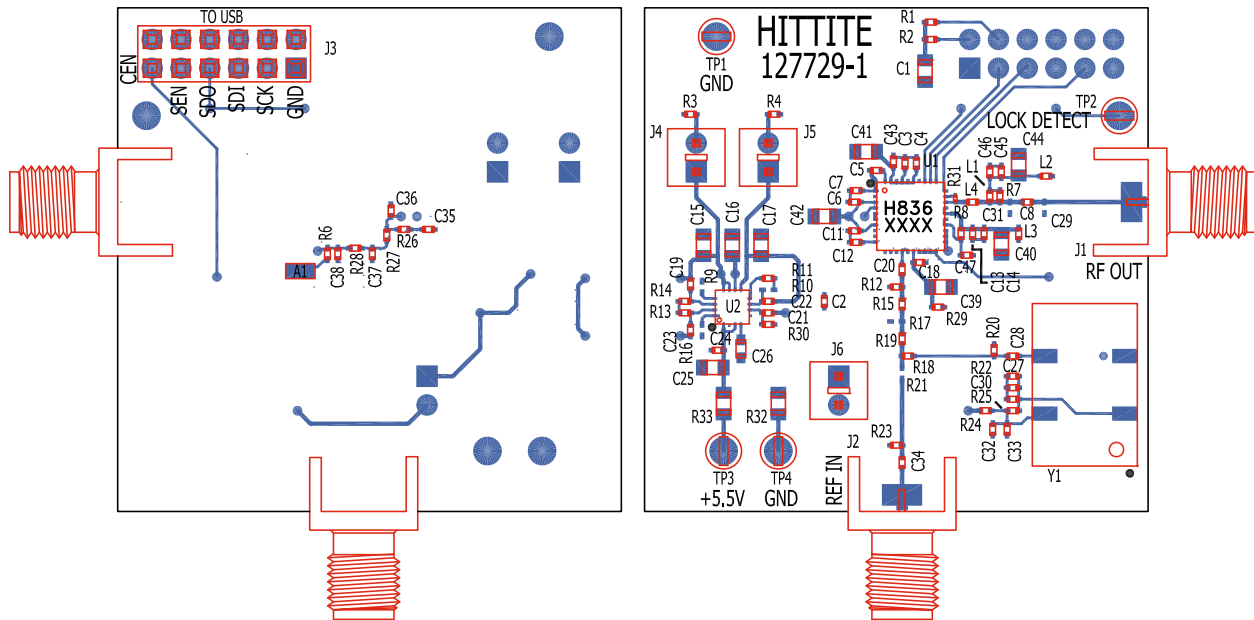

The circuit board used in the final application should use RF circuit design techniques. Signal lines should have 50 Ohm impedance while the package ground leads and exposed paddle should be connected directly to the ground plane similar to that shown. A sufficient number of via holes should be used to connect the top and bottom ground planes. The evaluation circuit board shown is available from Hittite upon request.

Evaluation PCB Schematic

To view this [Evaluation PCB Schematic](http://www.hittite.com) please visit www.hittite.com and choose HMC836LP6CE from the "Search by Part Number" pull down menu to view the product splash page.

Information furnished by Analog Devices is believed to be accurate and reliable. However, no responsibility is assumed by Analog Devices for its use, nor for any infringements of patents or other rights of third parties that may result from its use. Specifications subject to change without notice. No license is granted by implication or otherwise under any patent or patent rights of Analog Devices. Trademarks and registered trademarks are the property of their respective owners.

For price, delivery, and to place orders: Analog Devices, Inc., One Technology Way, P.O. Box 9106, Norwood, MA 02062-9106 Phone: 781-329-4700 • Order online at www.analog.com Application Support: Phone: 1-800-ANALOG-D

**FRACTIONAL-N PLL WITH
INTEGRATED VCO, 3365 - 3705 MHz**
List of Materials for Evaluation PCB 127832 [1]

| Item | Description |
|---|---|
| J1, J2 | PCB Mount SMA RF Connector |
| J3 | Dual Row Terminal Strip |
| J4 - J6 | Connector Header |
| C1, C15 - C17, C25 | 10 μ F Capacitor, 0805 Pkg. |
| C2, C3, C6, C7, C11, C12, C14, C18, C27, C43, C45 | 0.47 μ F Capacitor, 0402 Pkg. |
| C4, C13 | 22 pF Capacitor, 0402 Pkg. |
| C5, C33 | 1000 pF Capacitor, 0402 Pkg. |
| C8 | 8.2 pF Capacitor, 0402 Pkg. |
| C19 - C24, C28, C30, C32, C34 | 0.1 μ F Capacitor, 0402 Pkg. |
| C26 | 1.0 μ F Capacitor, 0603 Pkg. |
| C35 | 3300 pF Capacitor, 0402 Pkg. |
| C36 | 270 pF Capacitor, 0402 Pkg. |
| C37, C38 | 68 pF Capacitor, 0402 Pkg. |
| C39 - C42, C44 | 4.7 μ F Tantalum Capacitor, 0805 Pkg |
| C46 | 27 pF Capacitor, 0402 Pkg. |
| C47 | 47 pF Capacitor, 0402 Pkg. |
| R1, R2, R11, R15, R18, R19, R21, R24 | Zero Ohm Resistor, 0402 Pkg. |
| R3, R4 | 1 Ohm Resistor, 0402 Pkg. |
| R6 | 1 MOhm Resistor, 0402 Pkg. |
| R8 | 22 Ohm Resistor, 0402 Pkg. |
| R12, R20, R29 | 51 Ohm Resistor, 0402 Pkg. |
| R13, R14, R30 | 220 kOhm Resistor, 0402 Pkg. |
| R22, R25 | 20 kOhm Resistor, 0402 Pkg. |
| R26 - R28 | 1k Ohm Resistor, 0402 Pkg. |
| R32, R33 | 0 Ohm Resistor, 0805 Pkg. |
| L1 | 10 nH Inductor, 0402 Pkg. |
| L2 | 68 Ohm Resistor, 0402 Pkg. |
| L3 | 4.7 nH Inductor, 0402 Pkg. |
| L4 | 1.5 nH Inductor, 0402 Pkg. |
| TP3, TP4 | Test Point PC Compact SMT |
| U1 | HMC836LP6CE PLL with Integrated VCO |
| U2 | HMC860LP3E Low Noise Quad Linear Regulator |
| Y1 | 3.3V, 50 MHz VCXO Crystal Oscillator |
| PCB [2] | 127729 Evaluation Board |

[1] Reference this number when ordering complete evaluation PCB

[2] Circuit Board Material: Rogers 4350 or Arlon 25FR and FR4

**FRACTIONAL-N PLL WITH
INTEGRATED VCO, 3365 - 3705 MHz****Notes:**

X-ON Electronics

Largest Supplier of Electrical and Electronic Components

Click to view similar products for [Phase Locked Loops - PLL category](#):

Click to view products by [Analog Devices manufacturer](#):

Other Similar products are found below :

[CPLL58-2400-2500](#) [MB15E07SLPFV1-G-BND-6E1](#) [PI6C2409-1HWEX](#) [BA4116FV-E2](#) [HMC764LP6CETR](#) [HMC820LP6CETR](#)
[CY22050KFI](#) [LMX2430TMX/NOPB](#) [NB3N5573DTG](#) [ADF4153ABCPZ](#) [PI6C2405A-1LE](#) [CD74HC4046AM](#) [CPLL66-2450-2450](#)
[NJM567D](#) [74HC4046ADB.112](#) [74HC4046APW.112](#) [CY23S05SXI-1](#) [STW81200T](#) [ADF4208BRUZ](#) [ADF4218LBRUZ](#) [ADF4355-3BCPZ](#)
[ADF4355BCPZ](#) [ADF4355-2BCPZ-RL7](#) [ADF4169WCCPZ](#) [ADF4360-6BCPZ](#) [ADF4360-5BCPZRL7](#) [ADF4360-5BCPZ](#) [ADF4360-](#)
[4BCPZRL7](#) [ADF4360-4BCPZ](#) [ADF4360-3BCPZ](#) [ADF4360-2BCPZRL7](#) [ADF4252BCPZ](#) [ADF4159CCPZ](#) [ADF4169CCPZ](#) [ADF4360-](#)
[0BCPZ](#) [ADF4360-1BCPZ](#) [ADF4360-1BCPZRL7](#) [ADF4360-2BCPZ](#) [ADF4360-3BCPZRL7](#) [ADF4360-7BCPZRL7](#) [ADF4360-8BCPZ](#)
[ADF4360-8BCPZRL7](#) [ADF4360-9BCPZ](#) [ADF4360-9BCPZRL7](#) [ADF4159CCPZ-RL7](#) [ADF4159WCCPZ](#) [ADF4360-0BCPZRL7](#)
[AD9901KPZ](#) [AD9901KQ](#) [ADF4001BCPZ](#)