

FEATURES

High output power: 46 dBm typical at $P_{IN} = 23$ dBm
High small signal gain: 32.5 dB typical
High power gain: 23 dB typical at $P_{IN} = 23$ dBm
Frequency range: 9 GHz to 10.5 GHz
High power added efficiency: 40% typical at $P_{IN} = 23$ dBm
Supply voltage: $V_{DDxA}/V_{DDxB} = 28$ V at 1000 mA
6 mm × 6 mm, 40-lead LFSCP

APPLICATIONS

Weather radars
Marine radars
Military radars

GENERAL DESCRIPTION

The HMC8415LP6GE is a gallium nitride (GaN), power amplifier, delivering 40 W (46 dBm) with more than 37.5% power added efficiency (PAE) across a bandwidth of 9 GHz to 10.5 GHz.

FUNCTIONAL BLOCK DIAGRAM

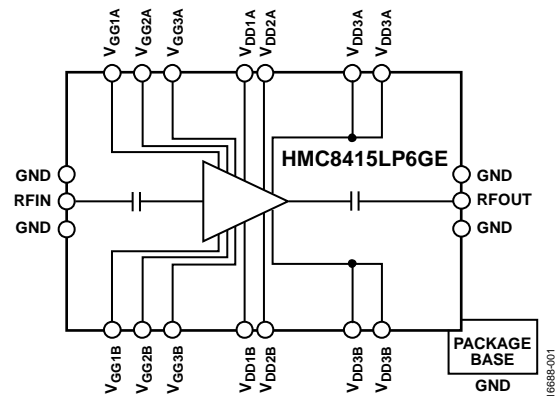

Figure 1.

The HMC8415LP6GE is ideal for pulsed applications, such as wireless weather, marine, and military radar applications.

TABLE OF CONTENTS

Features	1	Typical Performance Characteristics	8
Applications	1	Theory of Operation	14
Functional Block Diagram	1	Applications Information	15
General Description	1	Typical Application Circuit and Pulsor Circuit	17
Revision History	2	Using the EV1HMC8415LP6G with the Drain Bias Pulsor Board	19
Specifications	3	Recommended Bias Sequence	20
Electrical Specifications	3	Making Average to Pulsed Approximations	21
Total Target Quiescent Current by V_{DDxA}/V_{DDxB}	4	Evaluation PCB	22
Absolute Maximum Ratings	5	Bill of Materials	22
Thermal Resistance	5	Outline Dimensions	23
ESD Caution	5	Ordering Guide	23
Pin Configuration and Function Descriptions	6		
Interface Schematics	7		

REVISION HISTORY

4/2019—Rev. 0 to Rev. A

Change to Table 5	5
Updated Outline Dimensions	23
Changes to Ordering Guide	23

9/2018—Revision 0: Initial Version

SPECIFICATIONS

ELECTRICAL SPECIFICATIONS

$T_A = 25^\circ\text{C}$, $V_{DDxA}/V_{DDxB} = 28\text{ V}$, target quiescent current (I_{DQ}) = 1000 mA, drain bias pulse width = 100 μs , 10% duty cycle, and the frequency range = 9 GHz to 10 GHz, unless otherwise noted.

Table 1.

Parameter	Symbol	Min	Typ	Max	Unit	Test Conditions/Comments
FREQUENCY RANGE		9		10	GHz	
GAIN						
Small Signal		30	32.5		dB	Input power (P_{IN}) = 23 dBm $P_{IN} = 21\text{ dBm}$
Small Signal Flatness			1		dB	
Power Gain			23		dB	
			24		dB	
RETURN LOSS						
Input			20		dB	
Output			10		dB	
POWER						
Output Power	P_{OUT}		46		dBm	$P_{IN} = 23\text{ dBm}$
			45		dBm	$P_{IN} = 21\text{ dBm}$
Power Added Efficiency	PAE		40		%	$P_{IN} = 23\text{ dBm}$
			37.5		%	$P_{IN} = 21\text{ dBm}$
TARGET QUIESCENT CURRENT	I_{DQ}		1000		mA	Adjust the V_{GG} (V_{GGxA}/V_{GGxB}) between -4.0 V and -1.5 V to achieve an $I_{DQ} = 1000\text{ mA}$ typical, V_{GG} (V_{GGxA}/V_{GGxB}) = -2.5 V typical to achieve $I_{DQ} = 1000\text{ mA}$

$T_A = 25^\circ\text{C}$, $V_{DDxA}/V_{DDxB} = 28\text{ V}$, $I_{DQ} = 1000\text{ mA}$, drain bias pulse width = 100 μs , 10% duty cycle, and the frequency range = 10 GHz to 10.5 GHz, unless otherwise noted.

Table 2.

Parameter	Symbol	Min	Typ	Max	Unit	Test Conditions/Comments
FREQUENCY RANGE		10		10.5	GHz	
GAIN						
Small Signal		25.5	28		dB	$P_{IN} = 23\text{ dBm}$ $P_{IN} = 21\text{ dBm}$
Small Signal Flatness			5		dB	
Power Gain			22		dB	
			23.5		dB	
RETURN LOSS						
Input			17		dB	
Output			8		dB	
POWER						
Output Power	P_{OUT}		45		dBm	$P_{IN} = 23\text{ dBm}$
			44.5		dBm	$P_{IN} = 21\text{ dBm}$
Power Added Efficiency	PAE		37.5		%	$P_{IN} = 23\text{ dBm}$
			37.5		%	$P_{IN} = 21\text{ dBm}$
TARGET QUIESCENT CURRENT	I_{DQ}		1000		mA	Adjust the V_{GG} (V_{GGxA}/V_{GGxB}) between -4.0 V and -1.5 V to achieve an $I_{DQ} = 1000\text{ mA}$ typical, V_{GG} (V_{GGxA}/V_{GGxB}) = -2.5 V typical to achieve $I_{DQ} = 1000\text{ mA}$

TOTAL TARGET QUIESCENT CURRENT BY V_{DDxA}/V_{DDxB}

Table 3.

Parameter	Symbol	Min	Typ	Max	Unit	Test Conditions/Comments
TARGET QUIESCENT CURRENT	I_{DQ}					Adjust the V_{GG} (V_{GGxA}/V_{GGxB}) from -4.0 V to -1.5 V to achieve an $I_{DQ} = 1000$ mA typical
$V_{DDxA}/V_{DDxB} = 24$ V			1000		mA	
$V_{DDxA}/V_{DDxB} = 28$ V			1000		mA	
$V_{DDxA}/V_{DDxB} = 32$ V			1000		mA	

ABSOLUTE MAXIMUM RATINGS

Table 4.

Parameter	Rating
Bias Voltage	
Drain (V_{DDxA}/V_{DDxB})	35 V dc
Gate (V_{GGxA}/V_{GGxB})	-8 V dc to -1 V dc
Radio Frequency Input Power (RFIN)	30 dBm
Maximum Drain Bias	
Pulse Width (PW)	500 μ s
Duty Cycle	20%
Maximum Pulsed Power Dissipation, P_{DISS} ($T_{BASE} = 85^{\circ}\text{C}$, Derate 752 mW/ $^{\circ}\text{C}$ Above 85 $^{\circ}\text{C}$), Drain Bias Pulse Width = 200 μ s at 20% Duty Cycle	105.3 W
Nominal Pulsed Peak Channel Temperature, Drain Bias Pulse Width = 200 μ s at 20% Duty Cycle, $P_{IN} = 23$ dBm, $P_{DISS} = 58$ W at 9.0 GHz	162 $^{\circ}\text{C}$
Maximum Channel Temperature	225 $^{\circ}\text{C}$
Maximum Peak Reflow Temperature for Moisture Sensitivity Level 3 (MSL3) ¹	260 $^{\circ}\text{C}$
Storage Temperature Range	-65 $^{\circ}\text{C}$ to +150 $^{\circ}\text{C}$
Operating Temperature Range	-40 $^{\circ}\text{C}$ to +85 $^{\circ}\text{C}$
Electrostatic Discharge (ESD) Sensitivity Human Body Model (HBM)	Class 1A, Passed 250 V

¹ See the Ordering Guide section for additional information.

Stresses at or above those listed under Absolute Maximum Ratings may cause permanent damage to the product. This is a stress rating only; functional operation of the product at these or any other conditions above those indicated in the operational section of this specification is not implied. Operation beyond the maximum operating conditions for extended periods may affect product reliability.

THERMAL RESISTANCE

Thermal performance is directly linked to printed circuit board (PCB) design and operating environment. Careful attention to PCB thermal design is required.

θ_{JC} is the junction to case thermal resistance.

Table 5. Thermal Resistance

Package Type ^{1, 2}	θ_{JC}	Unit
CP-40-7	1.33	$^{\circ}\text{C}/\text{W}$

¹ The thermal resistance (θ_{JC}) was determined by measuring θ_{JC} under the following conditions: the heat transfer is due solely to the thermal conduction from the channel through the ground pad to the PCB, and the ground pad is held constant at the operating temperature of 85 $^{\circ}\text{C}$.

² Drain bias pulse width = 200 μ s at 20% duty cycle.

ESD CAUTION



ESD (electrostatic discharge) sensitive device. Charged devices and circuit boards can discharge without detection. Although this product features patented or proprietary protection circuitry, damage may occur on devices subjected to high energy ESD. Therefore, proper ESD precautions should be taken to avoid performance degradation or loss of functionality.

PIN CONFIGURATION AND FUNCTION DESCRIPTIONS

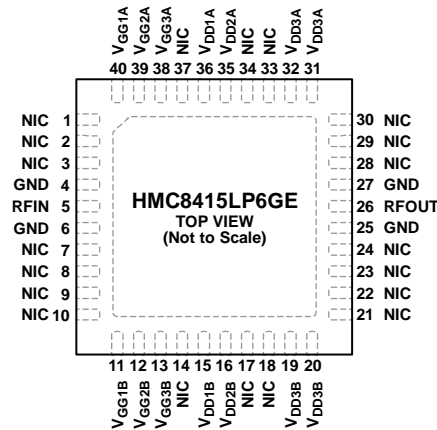

- NOTES**
 1. NIC = NO INTERNAL CONNECTION.
 2. EXPOSED PAD. THE EXPOSED PAD MUST BE CONNECTED TO RF AND DC GROUND.

16866-002

Figure 2. Pin Configuration

Table 6. Pin Function Descriptions

Pin No.	Mnemonic	Description
1 to 3, 7 to 10, 14, 17, 18, 21 to 24, 28 to 30, 33, 34, 37	NIC	No Internal Connection. These pins must be connected to RF and dc ground.
4, 6, 25, 27	GND	Ground. These pins must be connected to RF and dc ground. See Figure 3 for the GND interface schematic.
5	RFIN	RF Input. This pin is ac-coupled and matched to 50 Ω. See Figure 4 for the RFIN interface schematic.
11 to 13, 38 to 40	V _{GG1B} , V _{GG2B} , V _{GG3B} , V _{GG1A} , V _{GG2A} , V _{GG3A}	Gate Control Voltage Pins. External bypass capacitors of 1 μF, 100 pF, and 2.2 nF are required. See Figure 5 for the V _{GG1B} , V _{GG2B} , V _{GG3B} , V _{GG1A} , V _{GG2A} , and V _{GG3A} interface schematic.
15, 16, 19, 20, 31, 32, 35, 36	V _{DD1B} , V _{DD2B} , V _{DD3B} , V _{DD1A} , V _{DD2A} , V _{DD3A}	Drain Bias Pins for the Amplifier. External bypass capacitors of 1 nF and 3.3 Ω resistors are required. See Figure 7 for the V _{DD1B} , V _{DD2B} , V _{DD3B} , V _{DD1A} , V _{DD2A} , and V _{DD3A} interface schematic.
26	RFOUT	RF Output. This pin is ac-coupled and matched to 50 Ω. See Figure 6 for the RFOUT interface schematic.
	EPAD	Exposed Pad. The exposed pad must be connected to RF and dc ground.

INTERFACE SCHEMATICS



Figure 3. GND Interface Schematic

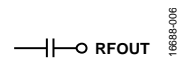

Figure 6. RFOUT Interface Schematic

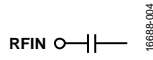

Figure 4. RFIN Interface Schematic

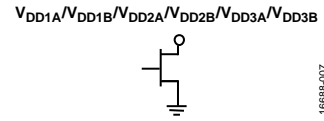

Figure 7. VDD1A, VDD1B, VDD2A, VDD2B, VDD3A, and VDD3B Interface Schematic

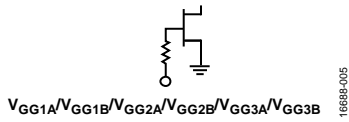

Figure 5. VGG1A, VGG1B, VGG2A, VGG2B, VGG3A, and VGG3B Interface Schematic

TYPICAL PERFORMANCE CHARACTERISTICS

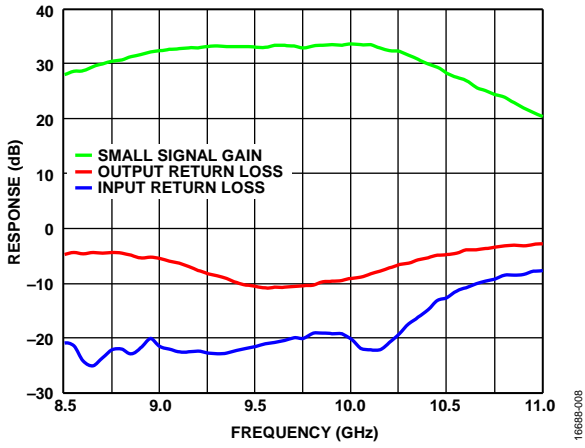

Figure 8. Small Signal Gain and Return Loss (Response) vs. Frequency

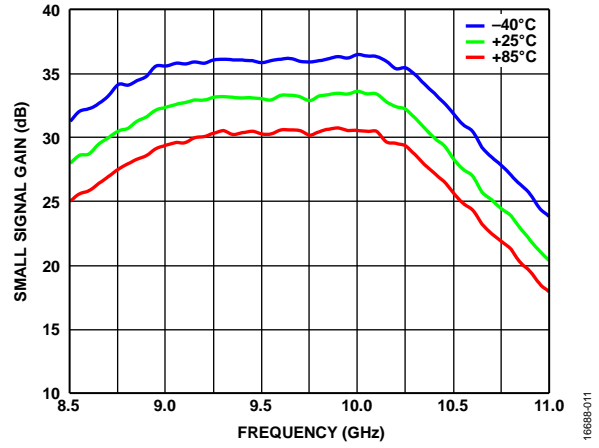

Figure 11. Small Signal Gain vs. Frequency at Various Temperatures

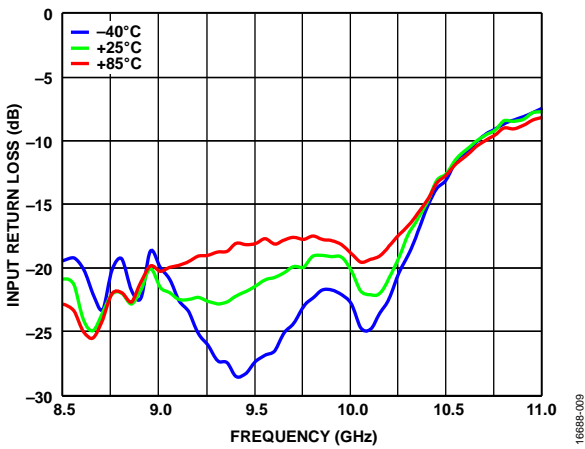

Figure 9. Input Return Loss vs. Frequency at Various Temperatures

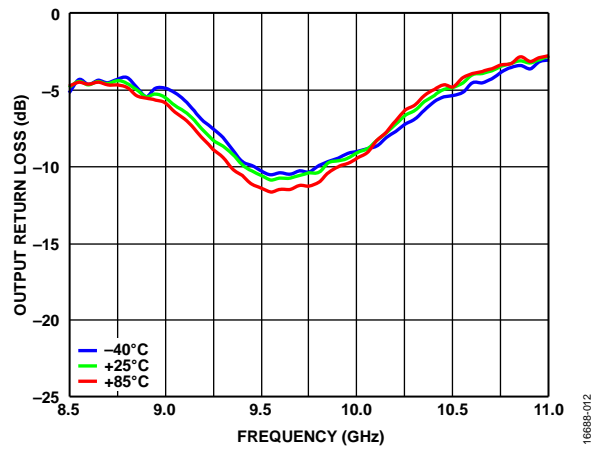

Figure 12. Output Return Loss vs. Frequency at Various Temperatures

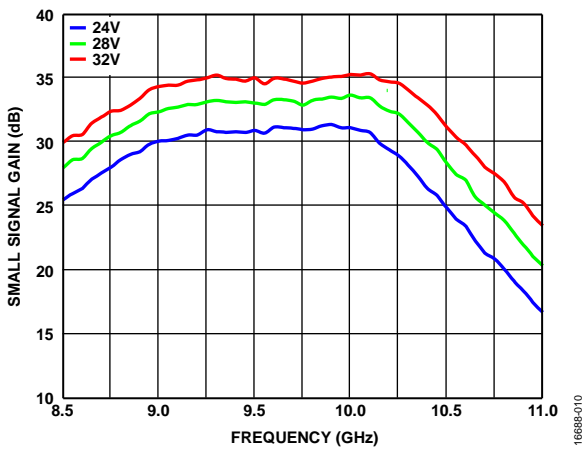

Figure 10. Small Signal Gain vs. Frequency at Various Supply Voltages at $I_{DQ} = 1000\text{ mA}$

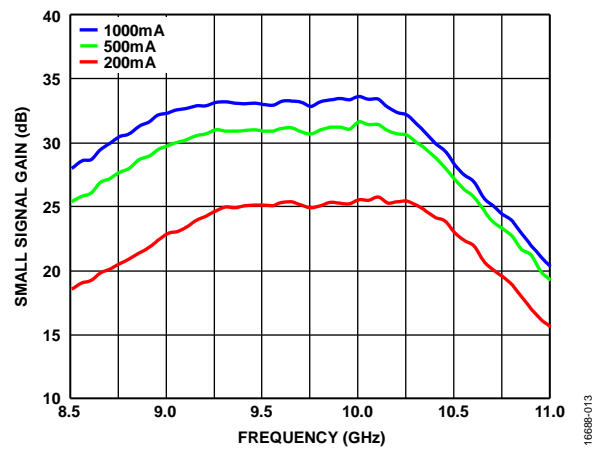

Figure 13. Small Signal Gain vs. Frequency at Various Quiescent Currents at $V_{DDxA}/V_{DDxB} = 28\text{ V}$

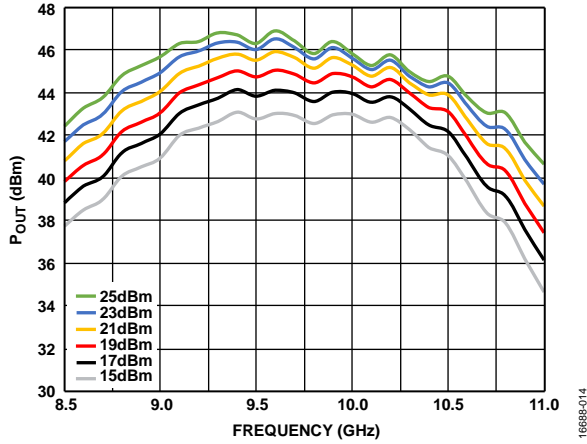

Figure 14. Output Power (P_{OUT}) vs. Frequency at Various Input Power (P_{IN}) Levels

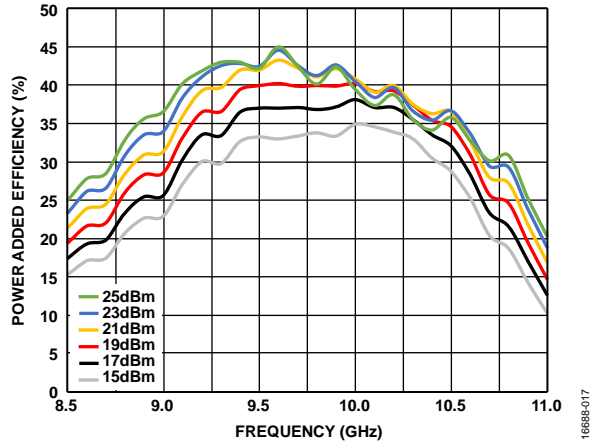

Figure 17. Power Added Efficiency vs. Frequency at Various P_{IN} Levels

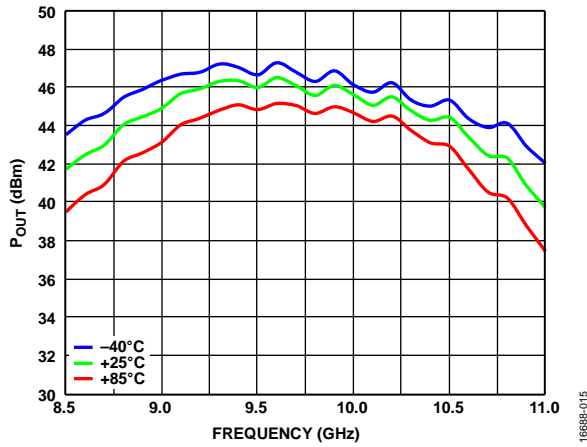

Figure 15. P_{OUT} vs. Frequency at Various Temperatures at $P_{IN} = 23$ dBm

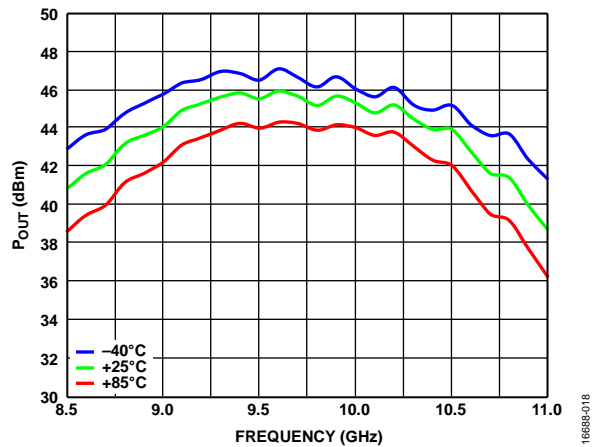

Figure 18. P_{OUT} vs. Frequency at Various Temperatures at $P_{IN} = 21$ dBm

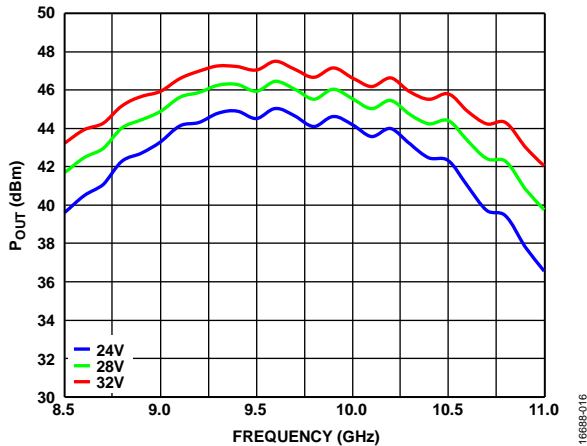

Figure 16. P_{OUT} at $P_{IN} = 23$ dBm vs. Frequency at Various Supply Voltages at $I_{DQ} = 1000$ mA

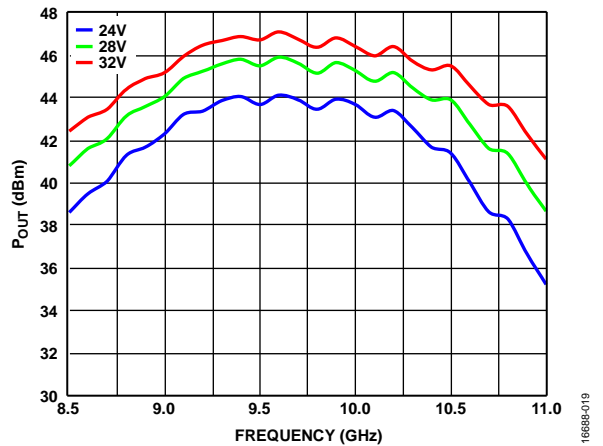

Figure 19. P_{OUT} at $P_{IN} = 21$ dBm vs. Frequency at Various Supply Voltages at $I_{DQ} = 1000$ mA

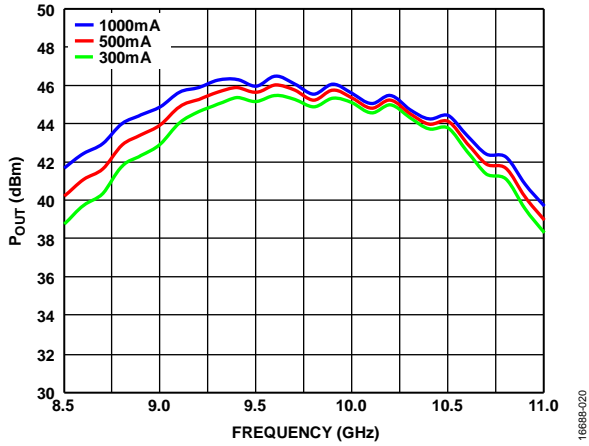

Figure 20. P_{OUT} at $P_{IN} = 23$ dBm vs. Frequency at Various Quiescent Currents at $V_{DDXA}/V_{DDXB} = 28$ V

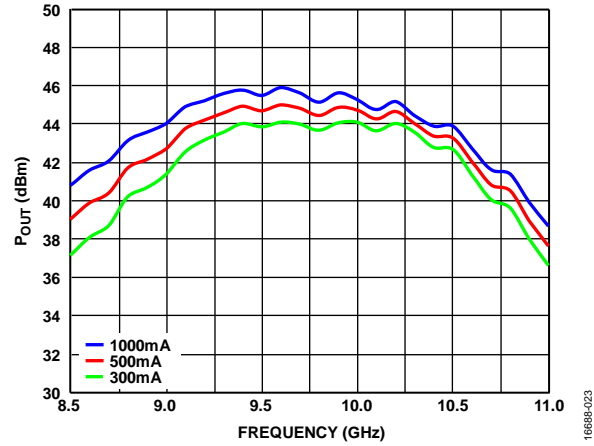

Figure 23. P_{OUT} at $P_{IN} = 21$ dBm vs. Frequency at Various Quiescent Currents at $V_{DDXA}/V_{DDXB} = 28$ V

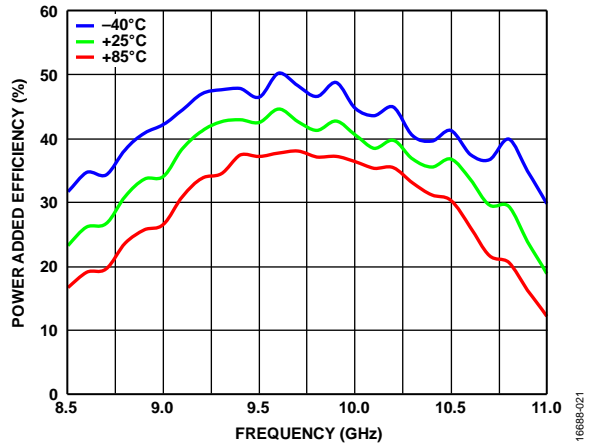

Figure 21. Power Added Efficiency at $P_{IN} = 23$ dBm vs. Frequency at Various Temperatures

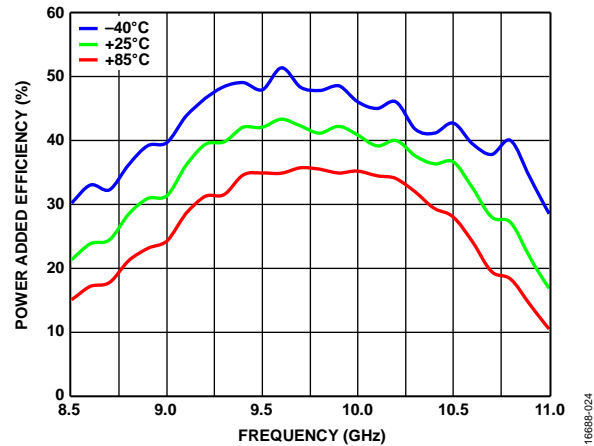

Figure 24. Power Added Efficiency at $P_{IN} = 21$ dBm vs. Frequency at Various Temperatures

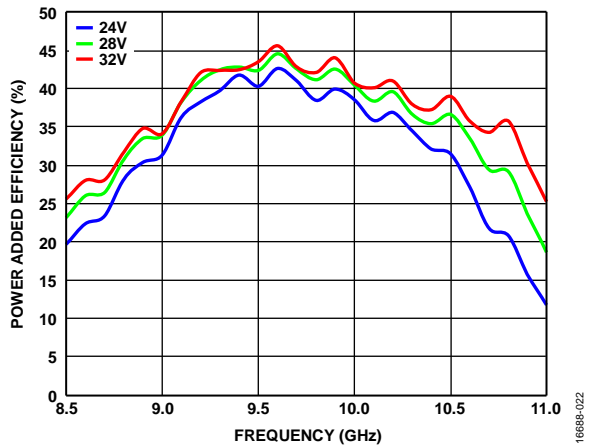

Figure 22. Power Added Efficiency at $P_{IN} = 23$ dBm vs. Frequency at Various Supply Voltages at $I_{DQ} = 1000$ mA

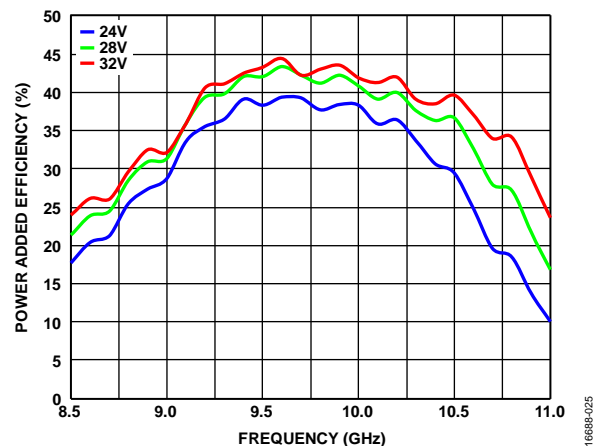

Figure 25. Power Added Efficiency at $P_{IN} = 21$ dBm vs. Frequency at Various Supply Voltages at $I_{DQ} = 1000$ mA

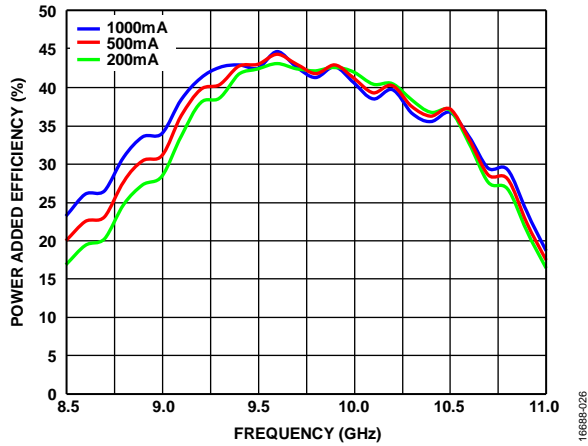

Figure 26. Power Added Efficiency at $P_{IN} = 23$ dBm vs. Frequency at Various Quiescent Currents, $V_{DDxA}/V_{DDxB} = 28$ V

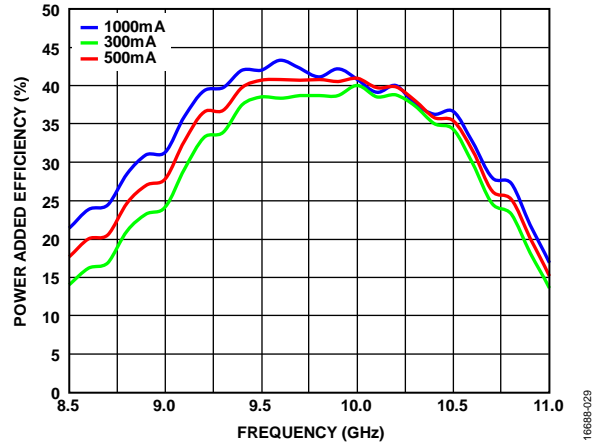

Figure 29. Power Added Efficiency at $P_{IN} = 21$ dBm vs. Frequency at Various Quiescent Currents, $V_{DDxA}/V_{DDxB} = 28$ V

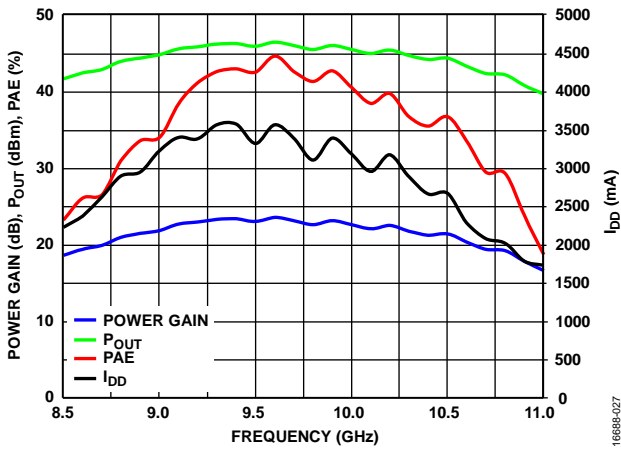

Figure 27. Power Gain, P_{OUT} , PAE, and Supply Current (I_{DD}) vs. Frequency at $P_{IN} = 23$ dBm

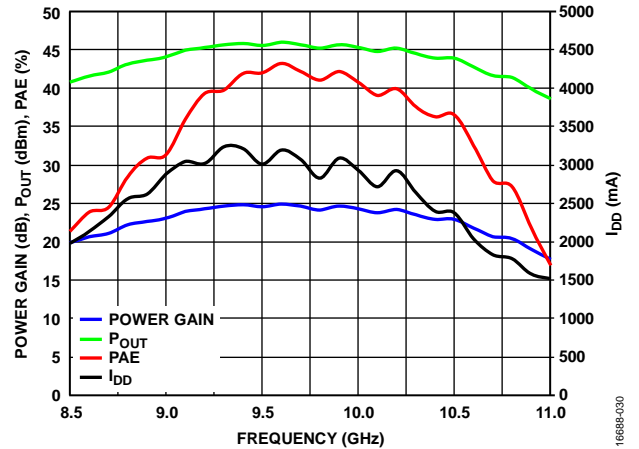

Figure 30. Power Gain, P_{OUT} , PAE, and I_{DD} vs. Frequency at $P_{IN} = 21$ dBm

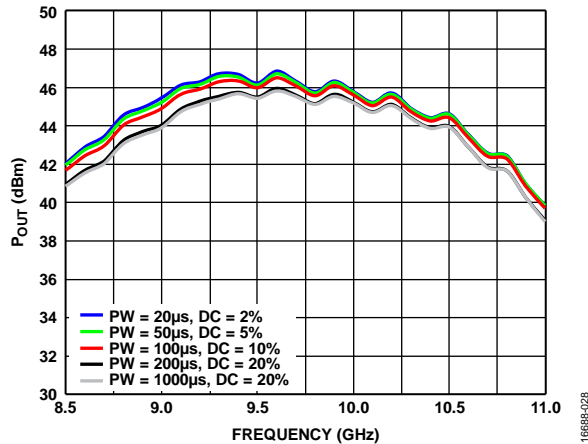

Figure 28. P_{OUT} vs. Frequency at Various Pulse Widths (PW) and Duty Cycles (DC) at $P_{IN} = 23$ dBm

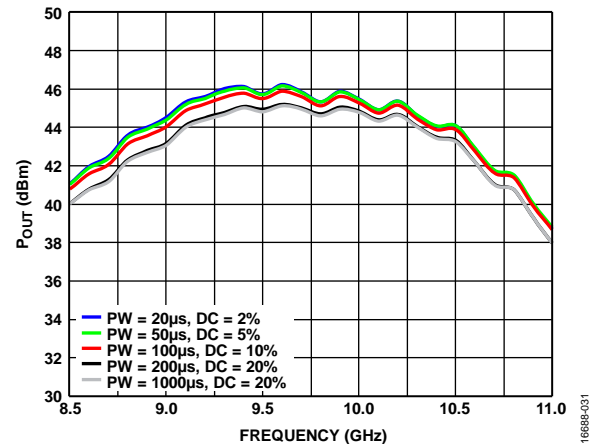

Figure 31. P_{OUT} vs. Frequency at Various Pulse Widths (PW) and Duty Cycles (DC) at $P_{IN} = 21$ dBm

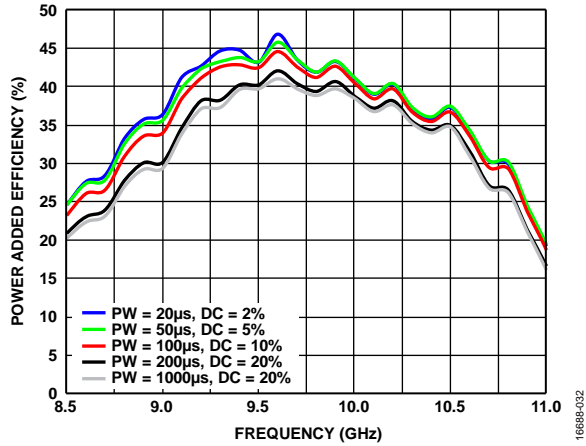

Figure 32. Power Added Efficiency vs. Frequency at Various Pulse Widths (PW) and Duty Cycles (DC) at $P_{IN} = 23$ dBm

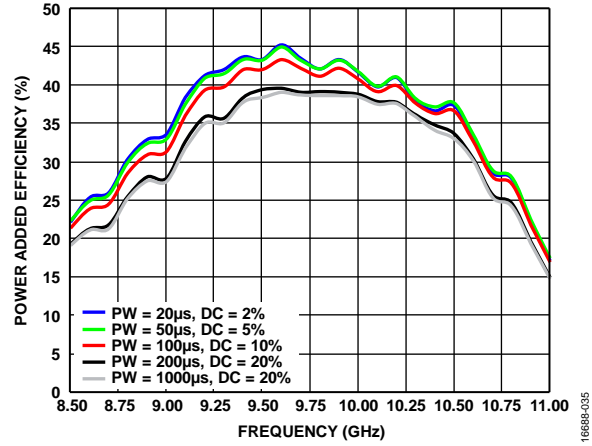

Figure 35. Power Added Efficiency vs. Frequency at Various Pulse Widths (PW) and Duty Cycles (DC) at $P_{IN} = 21$ dBm

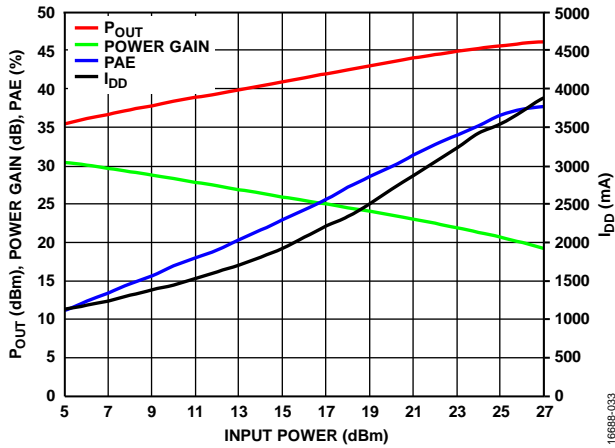

Figure 33. P_{OUT} , Power Gain, PAE, and I_{DD} vs. Input Power at 9.0 GHz

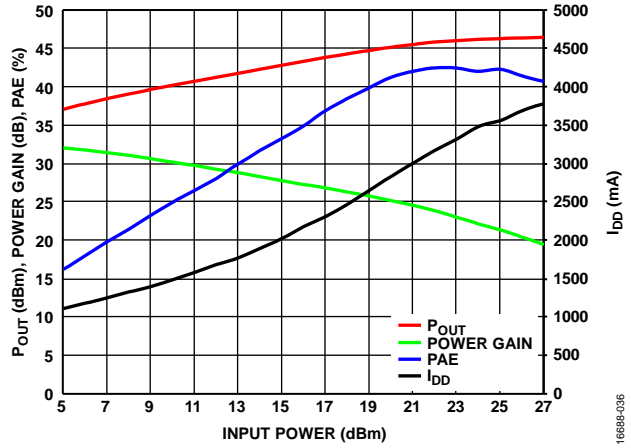

Figure 36. P_{OUT} , Power Gain, PAE, and I_{DD} vs. Input Power at 9.5 GHz

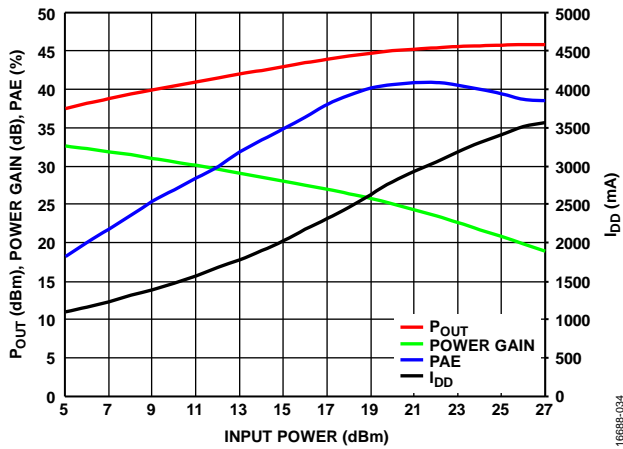

Figure 34. P_{OUT} , Power Gain, PAE, and I_{DD} vs. Input Power at 10 GHz

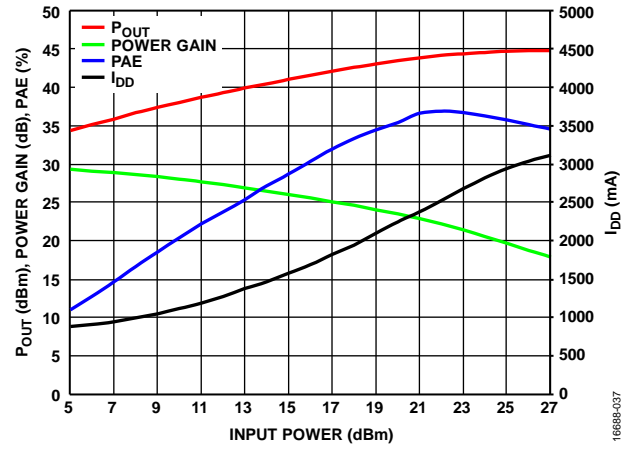

Figure 37. P_{OUT} , Power Gain, PAE, and I_{DD} vs. Input Power at 10.5 GHz

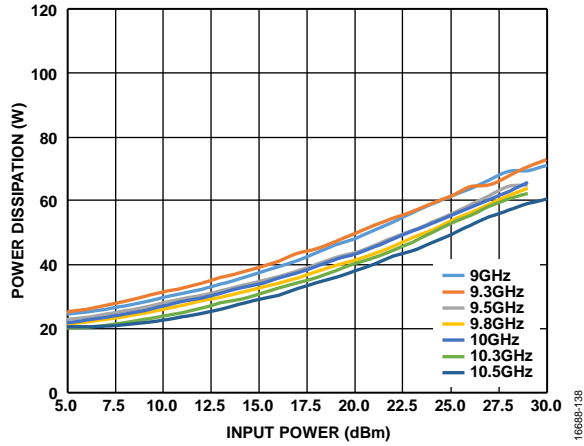

Figure 38. Power Dissipation vs. Input Power, Drain Bias Pulse Width = 100 μ s at 10% Duty Cycle

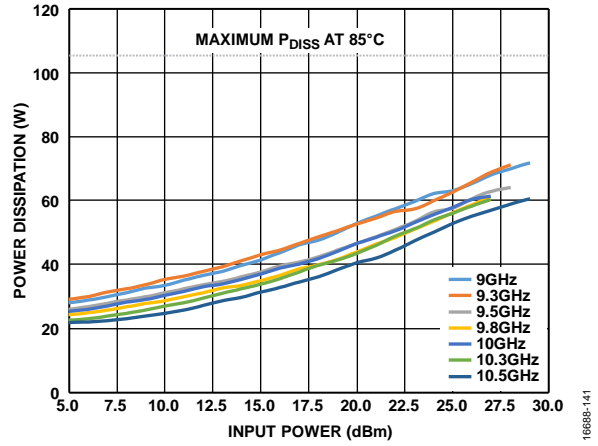

Figure 41. Power Dissipation (P_{DISS}) vs. Input Power, Drain Bias Pulse Width = 100 μ s at 10% Duty Cycle, Base Temperature (T_{BASE}) = 85°C

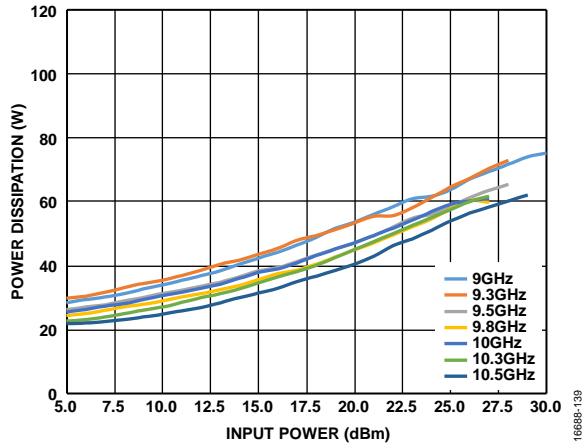

Figure 39. Power Dissipation vs. Input Power, Drain Bias Pulse Width = 20 μ s at 2% Duty Cycle

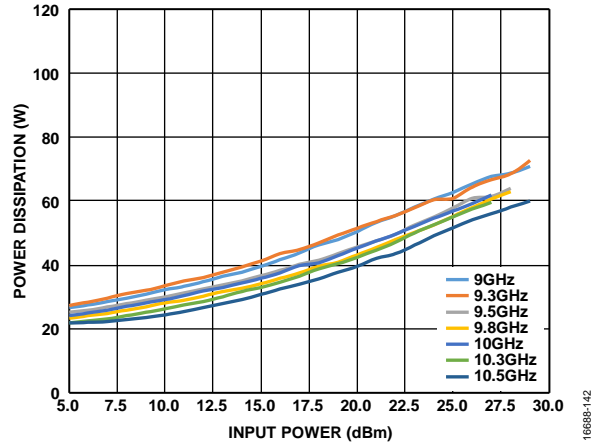

Figure 42. Power Dissipation vs. Input Power, Drain Bias Pulse Width = 200 μ s at 20% Duty Cycle

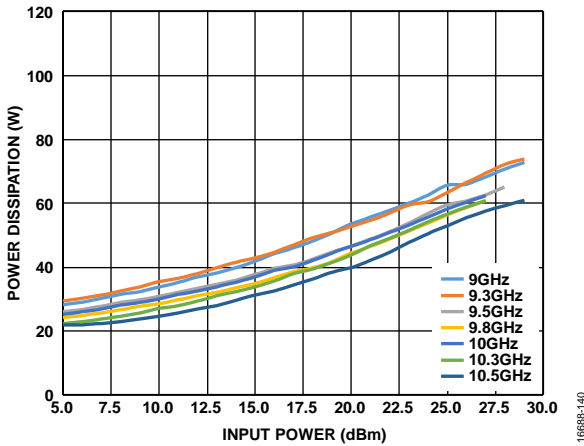

Figure 40. Power Dissipation vs. Input Power, Drain Bias Pulse Width = 50 μ s at 5% Duty Cycle

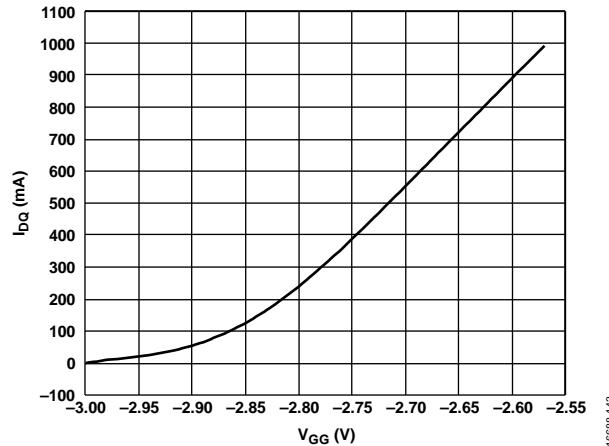

Figure 43. I_{DQ} vs. V_{GG} ($V_{GGx}/V_{GGx/B}$), $V_{DDx}/V_{DDx/B}$ = 28 V, Representative of a Typical Device

THEORY OF OPERATION

The HMC8415LP6GE is a gallium nitride (GaN) power amplifier capable of delivering 40 W (46 dBm) of pulsed power. The device consists of three cascaded gain stages and is configured with near mirror symmetry about the axis from RFIN to RFOUT. A simplified view of this architecture is shown in Figure 44.

The recommended dc bias conditions put the device into deep Class AB operation, allowing a moderate P_{IN} of 23 dBm to produce a typical pulsed P_{OUT} and PAE of 46 dBm and 40%, respectively, in the lower specified operating frequency range of 9 GHz to 10 GHz. The pulsed bias applied to the V_{DD1A}/V_{DD1B} , V_{DD2A}/V_{DD2B} , and V_{DD3A}/V_{DD3B} pins bias the drains of the first, second, and third gain stages, respectively. The dc voltages

applied to the V_{GG1A}/V_{GG1B} , V_{GG2A}/V_{GG2B} , and V_{GG3A}/V_{GG3B} pins bias the gates of the first, second, and third gain stages, respectively, allowing control of the drain currents for each stage.

The HMC8415LP6GE has single-ended RFIN and RFOUT ports that are dc blocked, and whose impedances are nominally 50 Ω over the 9 GHz to 10.5 GHz operating frequency range. Consequently, the HMC8415LP6GE can be directly inserted into a 50 Ω system without the need for external impedance matching components. Multiple HMC8415LP6GE amplifiers can be cascaded together without the need for external matching components or dc blocking capacitors.

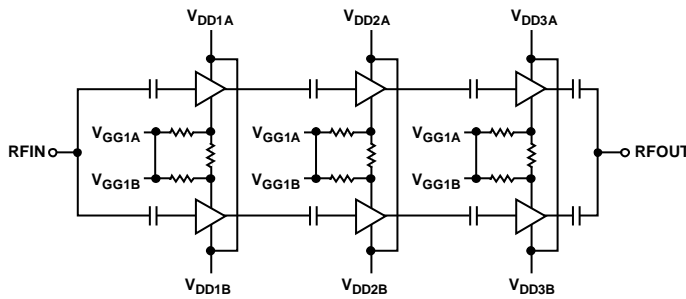

Figure 44. Basic Block Diagram

APPLICATIONS INFORMATION

Figure 47 shows the basic connections required for pulsed bias operation of the HMC8415LP6GE. To ensure stable operation, it is critical to provide the package base and all ground pins with low inductance connections to ground. Individually, bypass the six V_{DDX} pins using the 1 nF capacitors and 3.3 Ω resistors shown in Figure 47, then connect the pins to the drain bias supply farther away from the device. Similarly, individually bypass the six V_{GGX} pins capacitively, then connect the pins to the gate bias supply farther away from the device.

To achieve the specified performance and rated operating life, proper thermal management is critical. Thermal management is assisted by pulsed bias operation, which helps limit the average power dissipated, and thus, minimizing the channel temperature. Decreasing channel temperature corresponds with increasing the mean time to fail (MTTF). To better understand pulsed bias thermal parameters and the calculation of the resulting channel temperature, adjust the concept of thermal resistance from that of usual continuous bias conditions.

First, consider a continuous bias case (see Figure 45). When bias is applied, the channel temperature (T_{CHAN}) of the device rises through a turn-on transient interval and eventually settles to a steady state value. Calculate the thermal resistance of the device as the rise in T_{CHAN} above the starting base temperature (T_{BASE}) divided by the total power dissipated by the device.

$$\theta_{JC} = t_{RISE} / P_{DISS}$$

where:

θ_{JC} is the channel to base thermal resistance ($^{\circ}C/W$) of the device.

t_{RISE} is the rise in the T_{CHAN} of the device above the T_{BASE} ($^{\circ}C$).

P_{DISS} is the power dissipation (W) of the device.

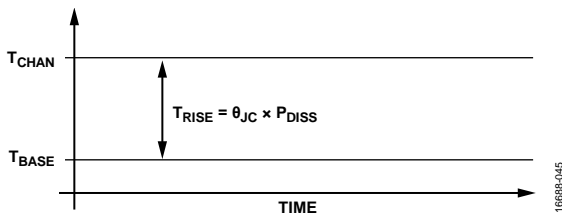

Figure 45. Continuous Bias

Now, consider a pulsed bias case at low duty cycle (see Figure 46). When bias is applied, the T_{CHAN} of the device can be described as a series of exponentially rising and decaying pulses. The peak channel temperature reached during consecutive pulses increases during the turn-on transient interval, eventually settling to a steady state condition, where peak channel temperatures from pulse to pulse stabilize. Calculate the thermal resistance of the device as the rise in T_{CHAN} above the starting T_{BASE} divided by the total power dissipated by the device.

$$\theta_{JC} = t_{RISE} / P_{DISS}$$

where:

θ_{JC} is the channel to base thermal resistance ($^{\circ}C/W$) of the device.

t_{RISE} is the peak rise in the T_{CHAN} of the device above the T_{BASE} ($^{\circ}C$).

P_{DISS} is the power dissipation (W) of the device during a bias pulse.

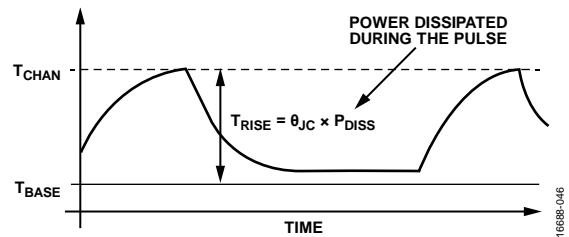

Figure 46. Pulsed Bias at Low Duty Cycle

Transient thermal measurements were performed on the HMC8415LP6GE amplifier at several different bias pulse widths and duty cycles to obtain the thermal resistance values in Table 7.

Table 7. Pulse Settings and Thermal Resistance Values

Pulse Settings		θ_{JC} ($^{\circ}C/W$)
Pulse Width (μs)	Duty Cycle (%)	
20	2	0.5
50	5	0.69
100	10	0.95
200	20	1.33

The largest total θ_{JC} listed in Table 7 is the same value as listed in Table 5 because this value represents the worst case, pulsed bias operation. Narrower pulse widths and/or lower duty cycles can result in greater reliability.

Even though the HMC8415LP6GE amplifier is designed for low duty cycle pulsed applications, there can be brief periods when the device operates (perhaps accidentally) under continuous bias conditions. The thermal resistance increases to $4^{\circ}C/W$ under such conditions. Even at the nominal quiescent bias (V_{DD} (V_{DDXA}/V_{DDXB}) = 28 V and $I_{DD} = 1$ A), the 28 W power dissipation results in a $112^{\circ}C$ channel temperature rise above the base temperature. Exercise extreme caution in such situations so that the device does not exceed the device maximum channel temperature of $225^{\circ}C$. If applying an RF input greater than -10 dBm during continuous wave (CW) operation, the device power dissipation increases above 28 W, resulting in an even greater temperature rise, possibly approaching the damage level of the device.

Pulsed bias can be achieved in different ways. However, typical applications hold the gate bias constant, pulse the drain bias on (28 V) when amplification is required, and pulse the drain bias off (0 V) when the drain bias is no longer required. Drain bias pulsing typically requires implementation of a pulsor circuit that consists of heavy duty power components, such as power metal-oxide semiconductor field effect transistors (MOSFETs), MOSFET drivers, and power rectifiers. Large capacitors are also required because these capacitors serve as local reservoirs of charge, helping to provide the drain current demanded by the HMC8415LP6GE while maintaining a steady drain voltage during the on time of the pulse.

An example of such a pulsor is the Analog Devices, Inc., custom drain pulsor board shown in Figure 48. The pulsor board was developed specifically for this application and is included with the HMC8415LP6GE evaluation kit, [EV1HMC8415LP6G](#). The HMC8415LP6GE characterization was performed on the

evaluation board, with VDD pulsing achieved through use of the pulsor board in combination with external dc voltage supplies for V_{DDxx} and V_{GGxx} and a pulse generator for triggering the VDD pulses. The dc connectors of both boards allow the boards to connect directly together without the need for extraneous flexible cabling. This rigid connection between the boards helps maintain a low inductance and low resistance connection, minimizing the occurrence of ringing and voltage drop. To help simplify the implementation of the HMC8415LP6GE with a drain bias pulsor circuit into customer applications, the complete drawing packages and bill of materials for both boards are available by submitting a [Technical Support Request](#).

Before attempting to connect the [EV1HMC8415LP6G](#) to the pulsor board, closely review the schematics of both boards (see Figure 47 and Figure 48).

TYPICAL APPLICATION CIRCUIT AND PULSOR CIRCUIT

Figure 47 shows the typical application circuit, and Figure 48 shows the drain bias typical pulsor circuit.

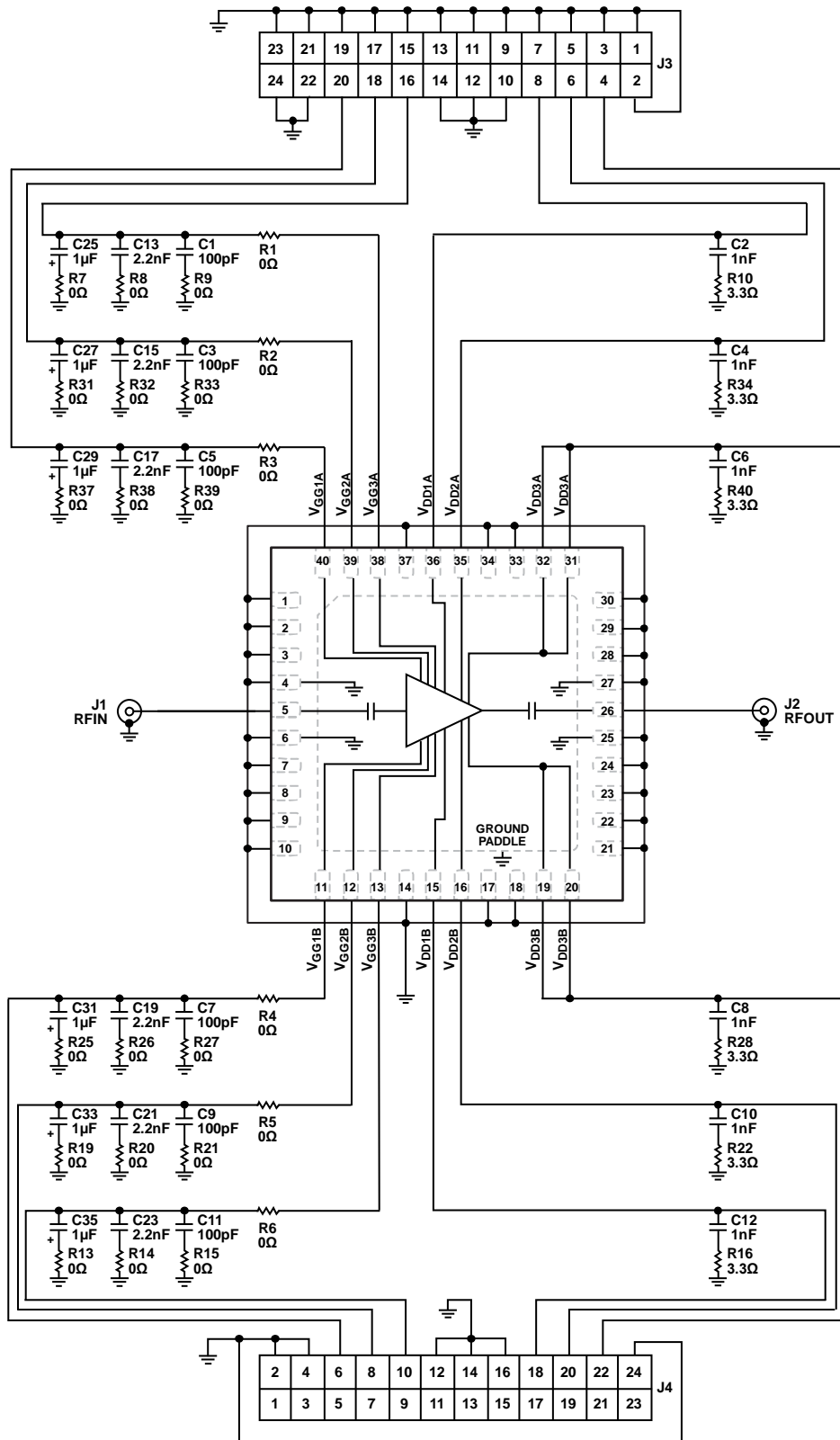

Figure 47. Typical Application Circuit
Rev. A | Page 17 of 23

1688B-039

30V DRAIN BIAS PULSER BOARD
SIMPLIFIED SCHEMATIC

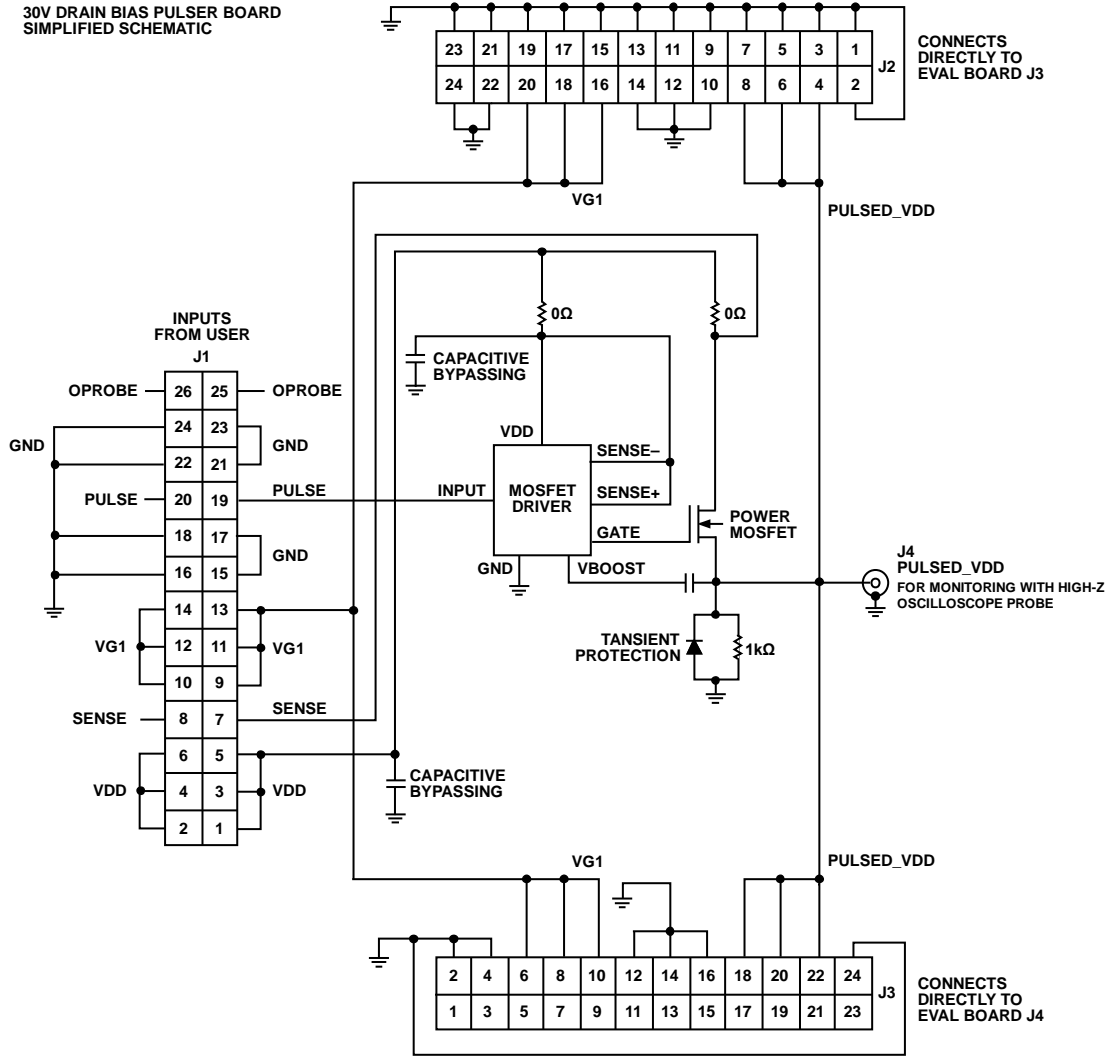

Figure 48. Typical Pulsor Circuit

16689-040

USING THE EV1HMC8415LP6G WITH THE DRAIN BIAS PULSOR BOARD

The following description assumes that pulsed measurements were made and that a current probe was used to measure I_{DD} . When neither is possible with the equipment available, approximations must be made as described in the Making Average to Pulsed Approximations section.

The connections required for using the EV1HMC8415LP6G with the drain bias pulsor board are shown in Figure 49. Before applying any bias or signals, the pulsor board must interconnect with the EV1HMC8415LP6G so that the pulsor board (J2) mates with the EV1HMC8415LP6G (J3) and the pulsor board (J3) mates with the EV1HMC8415LP6G (J4). The

only externally wired connections needed are to the J1 connector of the pulsor board: VDD, SENSE (from the +S VDD supply), VG1, PULSE, and all signal GNDs, including the -S VDD supply. VG1 passes from the Pulsor J1-VG1 directly through the pulsor board to the gate pins of the evaluation board. For the Pulsor J1-VDD and its GND connections, the use of heavy gauge twister pair wires is recommended to minimize voltage drop. The J4 coaxial connector of the pulsor board allows the convenient monitoring of the VDD_PULSE signal by using an oscilloscope.

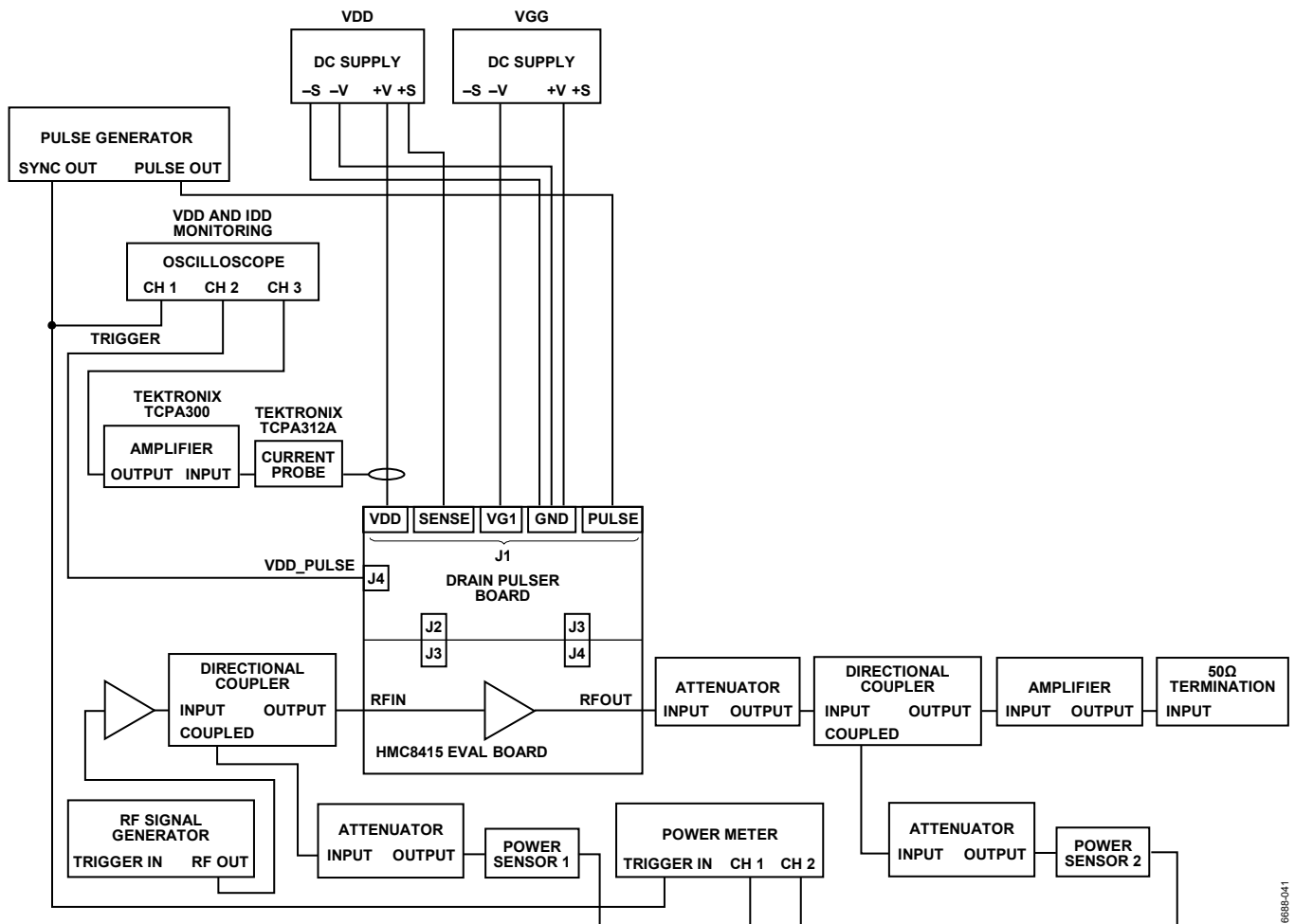

Figure 49. Setup Block Diagram

1668B-041

RECOMMENDED BIAS SEQUENCE***Power-Up Bias Concept for the EV1HMC8415LP6G with the Pulsor***

A proper set of dc bias conditions always requires that the gate be biased to a voltage that does not result in excessive drain current, regardless of whether the drain bias is constant or pulsed. For this reason, always apply a gate bias voltage to Pulsor J1-VG1 prior to the application of a voltage to Pulsor J1-VDD. VG1 = -6 V is considered a safe starting value. With a pulsed logic signal applied to Pulsor J1-PULSE and 28 V applied to Pulsor J1-VDD, a pulsed voltage between 0 V (for PULSE = logic low) and VDD = 28 V (for PULSE = logic high) becomes available at Pulsor J2-VDD_PULSE and Pulsor J3-VDD_PULSE and, therefore, at the drains of the device under test (DUT). When the gate bias voltage (applied to Pulsor J1-VG1) is available at the gates simultaneously with VDD_PULSE at the

drains, a drain current proportional to VG1 flows. VG1 can be adjusted until the target pulsed I_{DQ} is achieved. With this pulsor board, J1-VDD has a 35 V maximum above which damage can occur to the pulsor.

The J1-PULSE and VDD_PULSE pulse width and duty cycle limits for reliable operation are as follows:

- Pulse width = 500 μ s maximum
- Duty cycle = 20% maximum

Power-Down Bias Concept for the EV1HMC8415LP6G with the Pulsor

The power-down bias sequence follows from the power-up bias sequence. Bring Pulsor J1-PULSE to logic low to remove VDD_PULSE, and then power down Pulsor J1-VDD followed by powering down Pulsor J1-VG1.

MAKING AVERAGE TO PULSED APPROXIMATIONS

To measure RF power, I_{DD} , and PAE accurately in a pulsed manner, use instruments offering pulse triggered measurements. When pulse triggered instruments are not available but simpler instruments with adequate averaging capabilities are, approximations can be made with the understanding that the approximations can result in lower accuracy of measurement. The most common approximations involve measuring the average values of parameters and then adjusting those values to account for the duty cycle of operation. Approximating in this manner can result in errors due to the limited measurement bandwidths of the instruments and/or the inclusion of on/off transients and/or partial periods in the measurement. So that partial periods do not contribute significant errors to the measurements, perform the averaging over a large number of pulse periods. The results of such approximations can vary with the instruments and settings used. Therefore, experimentation can be necessary to achieve credible and repeatable results. When it is not possible to make pulse triggered measurements, the only pulse connection required is the one from the pulse generator to the J1 connector of the pulsor (see Figure 49).

Depending on the implementation of the HMC8415LP6GE and the pulsor into customer applications, adjustments of the pulse circuit may be desired if the on and off transitions are accompanied by excessive drain supply ringing. Synchronous with the drain pulses, the V_{GGxx} bias and RFIN signal can also be pulsed.

Unless otherwise noted, all measurement data shown within this data sheet was taken using the typical application circuit (see Figure 47) as implemented on the evaluation board (see Figure 50), with the drain bias pulsed at 28 V by the pulsor board (see Figure 48) to achieve the nominal I_{DQ} of 1000 mA at a pulse width of 100 μ s, and 10% duty cycle. Operating at different drain voltages or different drain quiescent currents affects performance, as shown in the Typical Performance Characteristics section. For applications having lower power and gain requirements, operation at lower V_{DDxx} and I_{DQ} can help reduce power consumption. Due to thermal considerations, the use of lower duty cycles and shorter pulse widths can sometimes result in improved power and PAE.

EVALUATION PCB

The EV1HMC8415LP6G (600-01639-00-2) evaluation PCB is shown in Figure 50.

BILL OF MATERIALS

Use RF circuit design techniques for the circuit board used in the application. Provide 50 Ω impedance for the signal lines and directly connect the package ground leads and exposed pad to the ground plane, similar to that shown in Figure 50. Use a sufficient number of via holes to connect the top and bottom ground planes. The evaluation PCB shown in Figure 50 is available from Analog Devices upon request.

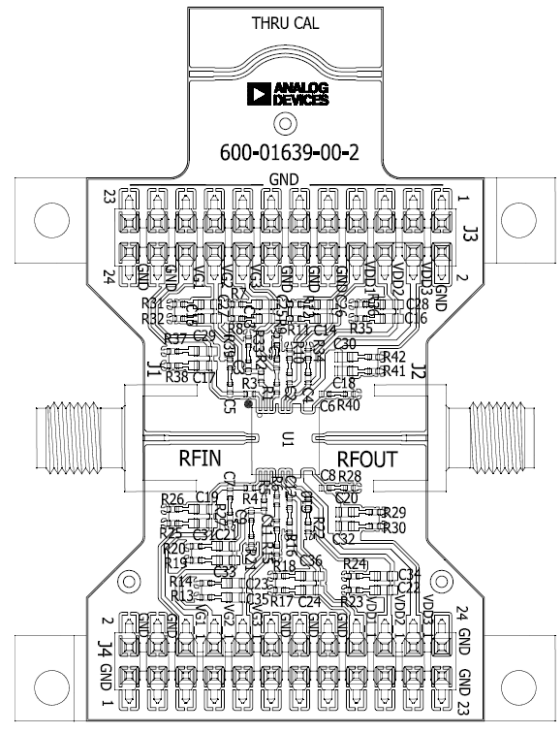
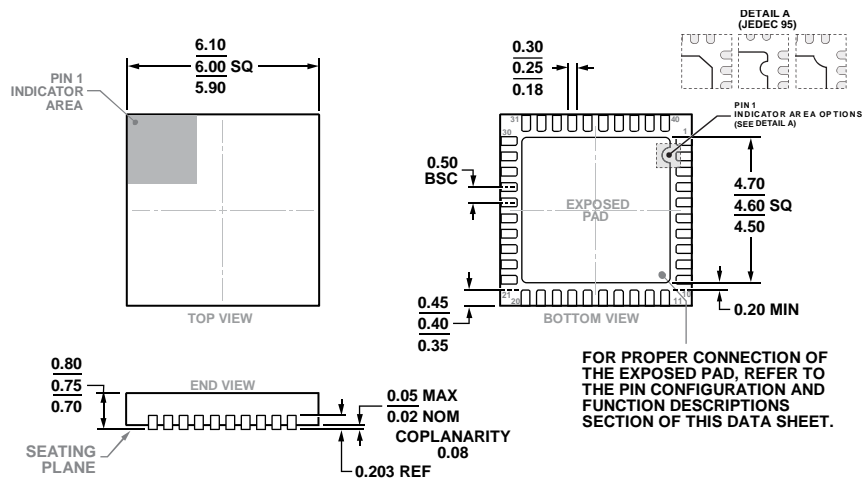

Figure 50. Evaluation PCB

Table 8. Bill of Materials for the Evaluation PCB EV1HMC8415LP6G (600-01639-00-2)

Item	Description
J1, J2	SMA connectors
J3, J4	DC pins
R1 to R9, R13 to R15, R19 to R21, R25 to R27, R31 to R33, R37 to R39	0 Ω resistors, 0402 package
C2, C4, C6, C8, C10, C12	1000 pF capacitors, 0402 package
C1, C3, C5, C7, C9, C11	100 pF capacitors, 0402 package
C13, C15, C17, C19, C21, C23	2200 pF capacitors, 0603 package
C25, C27, C29, C31, C33, C35	1 μF capacitors, 0603 package
U1	HMC8415LP6GE
PCB	600-01639-00-2 evaluation PCB; circuit board material: Rogers 4350 or Arlon 25FR

OUTLINE DIMENSIONS



COMPLIANT TO JEDEC STANDARDS MO-220-WJJD-5

Figure 51. 40-Lead Lead Frame Chip Scale Package [LFCSP]
 6 mm × 6 mm Body and 0.75 mm Package Height
 (CP-40-7)
 Dimensions shown in millimeters

ORDERING GUIDE

Model ¹	Temperature Range	MSL Rating ²	Package Description ³	Package Option
HMC8415LP6GE	-40°C to +85°C	3	40-Lead Lead Frame Chip Scale Package [LFCSP]	CP-40-7
HMC8415LP6GETR	-40°C to +85°C	3	40-Lead Lead Frame Chip Scale Package [LFCSP]	CP-40-7
EV1HMC8415LP6G			Evaluation Board	

¹ The HMC8415LP6GE and HMC8415LP6GETR are RoHS compliant parts.

² See the Absolute Maximum Ratings section for additional information.

³ The HMC8415LP6GE and the HMC8415LP6GETR are low stress injection molded plastic and their lead finish is 100% matte Sn.

X-ON Electronics

Largest Supplier of Electrical and Electronic Components

Click to view similar products for [RF Amplifier](#) category:

Click to view products by [Analog Devices](#) manufacturer:

Other Similar products are found below :

[ADPA7006AEHZ](#) [CXE2089ZSR](#) [MGA-43828-BLKG](#) [A82-1](#) [RF2878TR7](#) [BGA 728L7 E6327](#) [BGB719N7ESDE6327XTMA1](#) [HMC1126-SX](#) [HMC342](#) [HMC561-SX](#) [HMC598-SX](#) [HMC-ALH382-SX](#) [HMC-ALH476-SX](#) [SE2433T-R](#) [SE2622L-R](#) [SMA3101-TL-E](#) [SMA39](#) [SMA70-1](#) [A66-1](#) [A66-3](#) [A67-1](#) [LX5535LQ](#) [LX5540LL](#) [RF2373TR7](#) [HMC3653LP3BETR](#) [HMC395](#) [HMC549MS8GETR](#) [HMC576-SX](#) [HMC754S8GETR](#) [HMC-ALH435-SX](#) [SMA101](#) [SMA1031](#) [SMA181](#) [SMA32](#) [SMA411](#) [SMA531](#) [SST12LP17E-XX8E](#) [SST12LP19E-QX6E](#) [TGA2598](#) [WPM0510A](#) [HMC5929LS6TR](#) [HMC5879LS7TR](#) [HMC906A-SX](#) [HMC1127](#) [HMC544A](#) [HMC1126](#) [HMC1110-SX](#) [HMC1087F10](#) [HMC1086](#) [HMC1016](#)