

## GaAs pHEMT MMIC 2 WATT POWER AMPLIFIER, 27.3 - 33.5 GHz

### Typical Applications

The HMC906A is ideal for:

- Satellite Communications
- Point-to-Point Radios
- Point-to-Multi-Point Radios
- VSAT
- Military & Space

### Functional Diagram

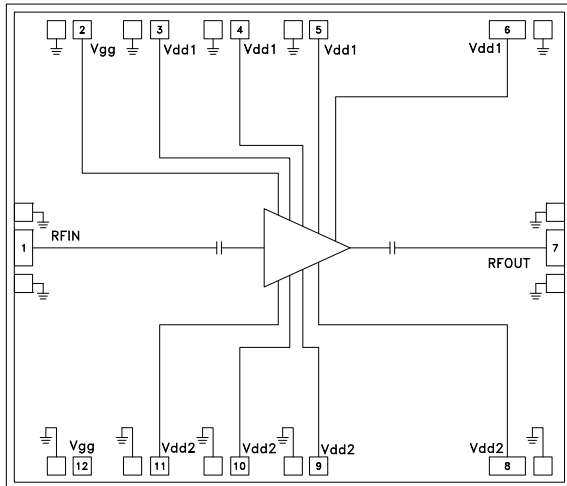

### Features

- Saturated Output Power: +33.5 dBm @ 20% PAE
- High Output IP3: +44 dBm @ +24 dBm / tone
- High Gain: 26.5 dB
- DC Supply: +6V @ 1200 mA
- No External Matching Required
- Die Size: 3.18 x 2.73 x 0.1 mm

### General Description

The HMC906A is a four stage GaAs pHEMT MMIC 2 Watt Power Amplifier which operates between 27.3 and 33.5 GHz. The HMC906A provides 26.5 dB of gain, and +33.5 dBm of saturated output power and 20% PAE from a +6V supply. The OIP3 of 40 dBm at 28 dBm / tone provides excellent linearity for satellite communications. The RF I/Os are DC blocked and matched to 50 Ohms for ease of integration into Multi-Chip-Modules (MCMs). All data is taken with the chip in a 50 Ohm test fixture connected via two 0.025 mm (1 mil) diameter wire bonds of length 0.31 mm (12 mils).

### Electrical Specifications, $T_A = +25^\circ\text{C}$ , $V_{dd1} = V_{dd2} = +6\text{V}$ , $I_{dd} = 1200\text{mA}$ [1]

Parameter	Min.	Typ.	Max.	Min.	Typ.	Max.	Units
Frequency Range	27.3 - 31.5		31.5 - 33.5				GHz
Gain	25	26.5		25	26.5		dB
Input Return Loss		14			12		
Output Return Loss		17			16		dB
Output Power for 1 dB Compression (P1dB)	32	33		31.5	33.5		dBm
Saturated Output Power (P <sub>sat</sub> )		33.5			34		dBm
Output Third Order Intercept (IP3) P <sub>out</sub> / tone = +24 dBm		44			43		dBm
Total Supply Current (I <sub>dd</sub> )		1200			1200		mA
Supply Voltage	5	6	6.5	5	6	6.5	V

[1] Adjust Vgg (pad 2 or 12) between -2 to 0V to achieve I<sub>dd</sub> = 1200 mA typical. Vgg typical = -0.7 V

**GaAs pHEMT MMIC 2 WATT  
POWER AMPLIFIER, 27.3 - 33.5 GHz**

**Gain & Return Loss**

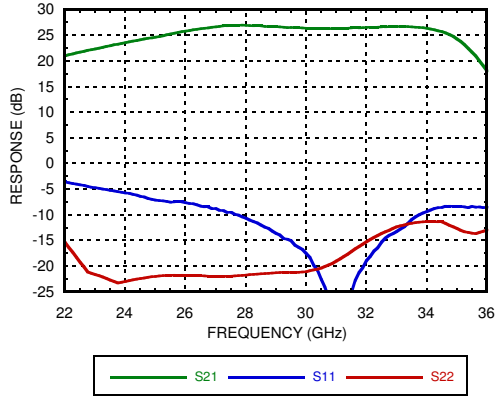

**Gain vs. Temperature**

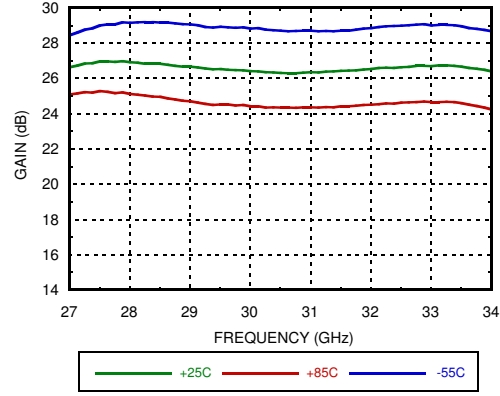

**Gain vs. Vdd**

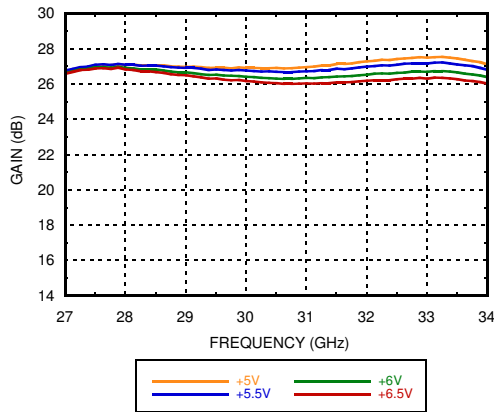

**Gain vs. Idd**

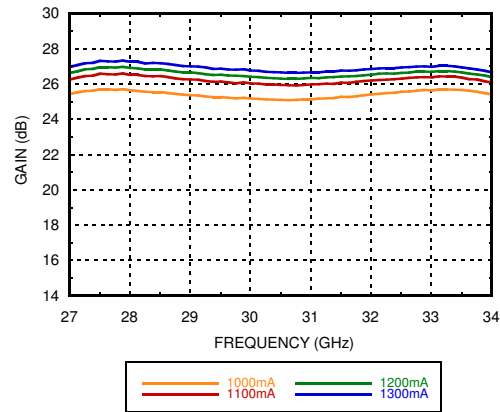

**Input Return Loss vs. Temperature**

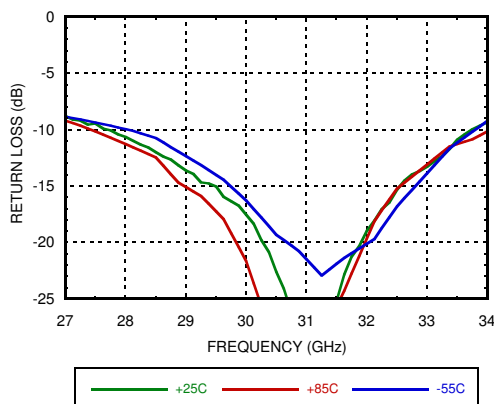

**Output Return Loss vs. Temperature**

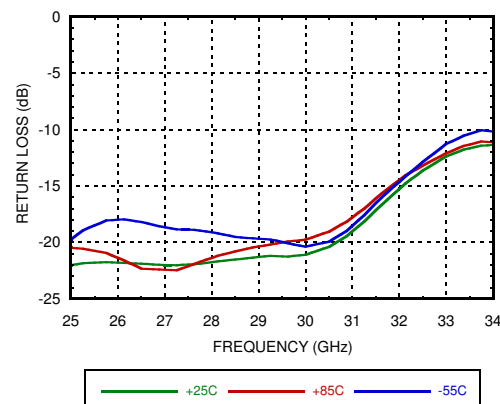

**GaAs pHEMT MMIC 2 WATT  
POWER AMPLIFIER, 27.3 - 33.5 GHz**

**Reverse Isolation vs. Temperature**

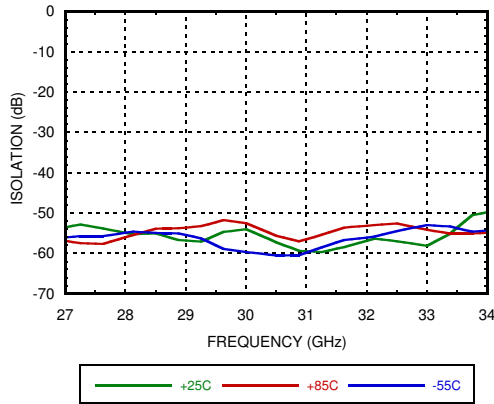

**P1dB vs. Temperature**

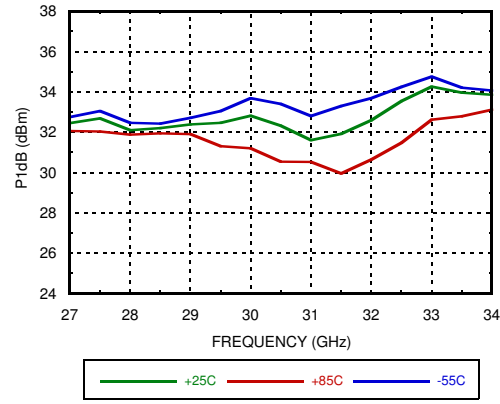

**Psat vs. Temperature**

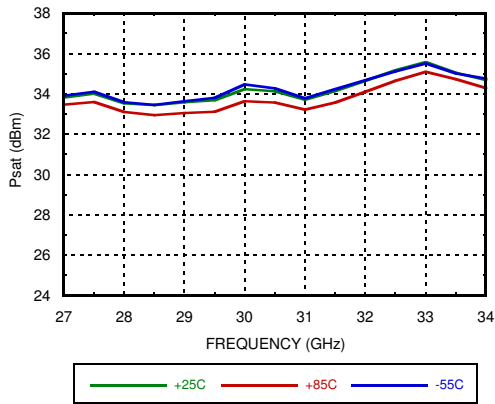

**P1dB vs. Vdd**

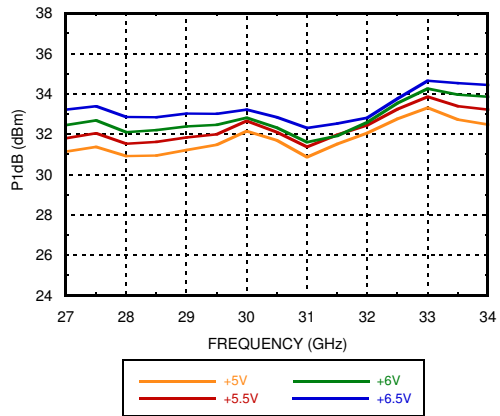

**Psat vs. Vdd**

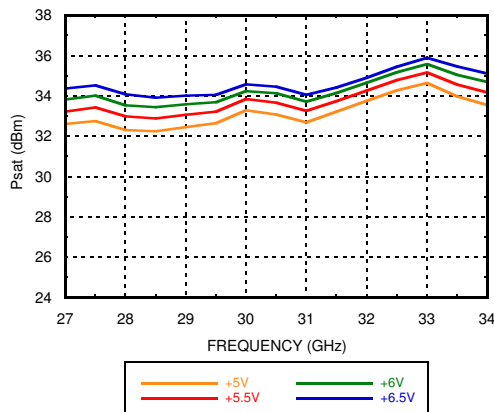

**P1dB vs. Idd**

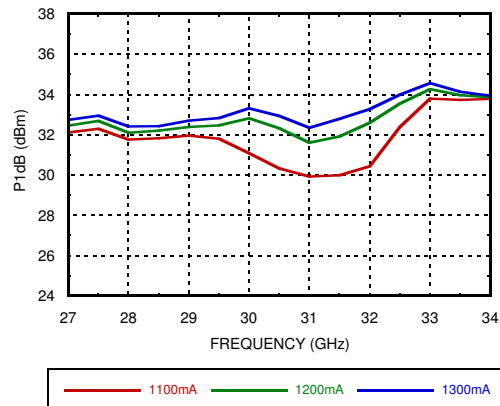

**GaAs pHEMT MMIC 2 WATT  
POWER AMPLIFIER, 27.3 - 33.5 GHz**

**Psat vs. Idd**

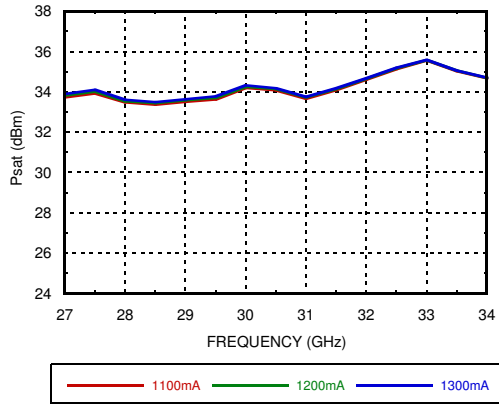

**Power Compression @ 30 GHz**

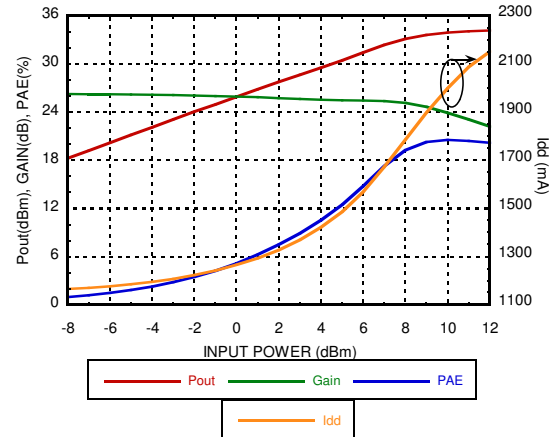

**Gain and Power vs. Idd @ 30 GHz**

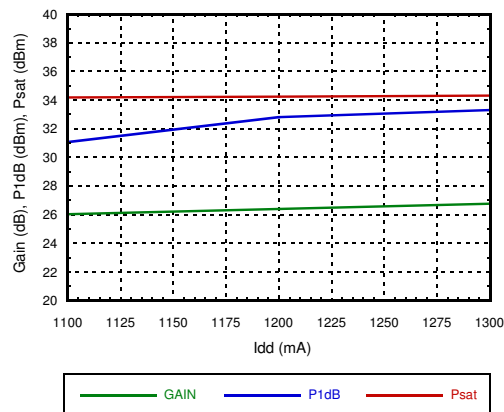

**Gain and Power vs. Vdd @ 30 GHz**

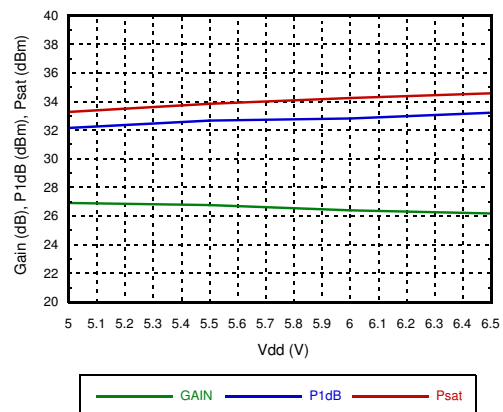

**PAE @ Psat vs. Temperature**

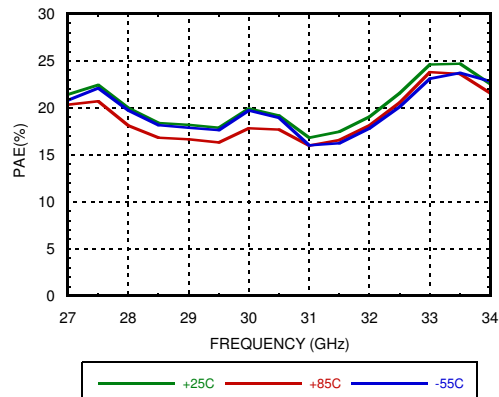

**Power Dissipation @ 85C**

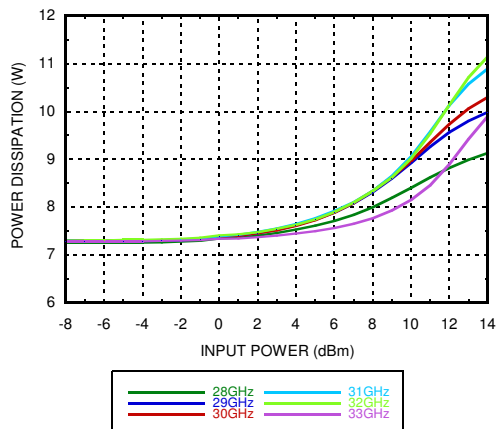

**GaAs pHEMT MMIC 2 WATT  
POWER AMPLIFIER, 27.3 - 33.5 GHz**

AMPLIFIERS - LINEAR & POWER - CHIP

**Output IP3 vs. Temperature,  
Pout/Tone = +24 dBm**

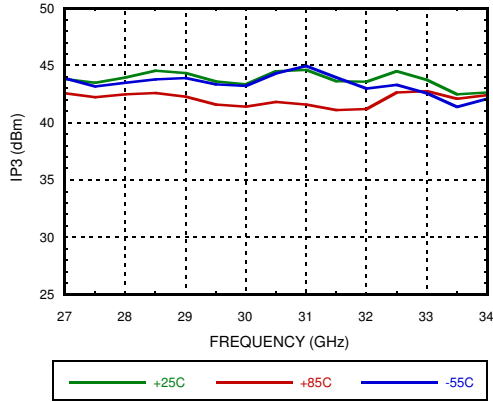

**Output IP3 vs. Temperature,  
Pout/Tone = +28 dBm**

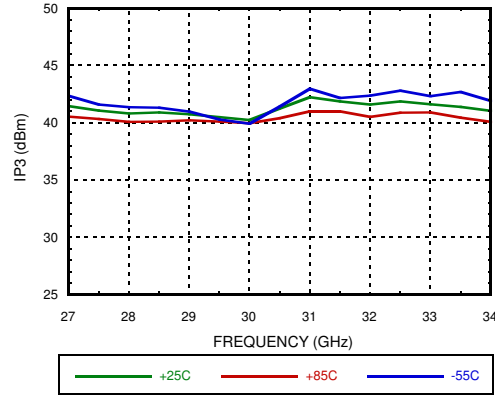

**Output IP3 vs. Vdd,  
Pout/Tone = +24 dBm**

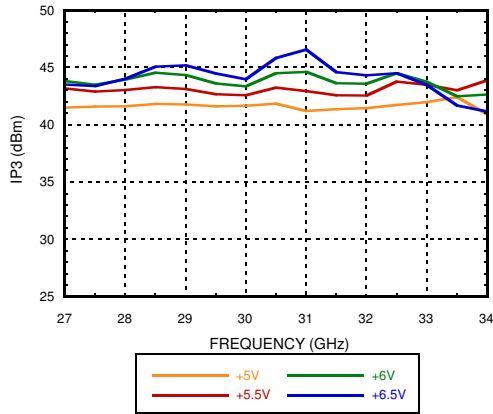

**Output IP3 vs. Vdd,  
Pout/Tone = +28 dBm**

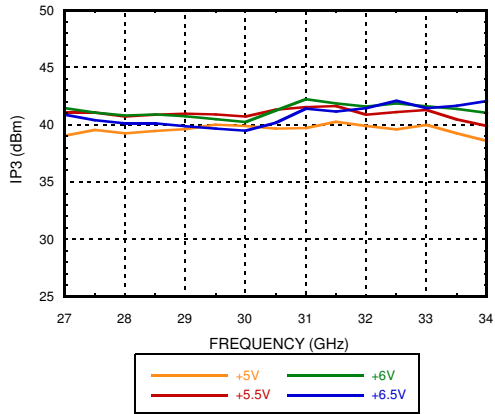

**Output IP3 vs. Idd,  
Pout/Tone = +24 dBm**

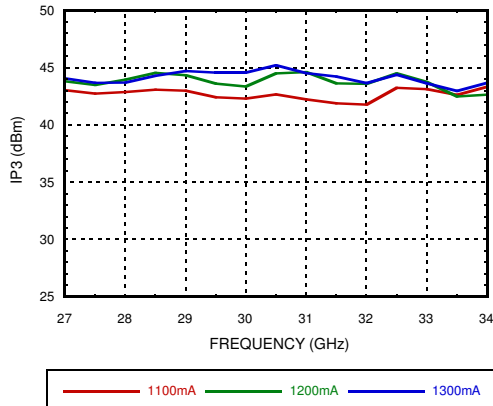

**Output IP3 vs. Idd,  
Pout/Tone = +28 dBm**

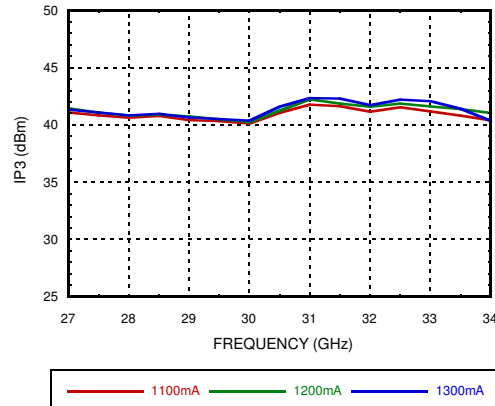

**GaAs pHEMT MMIC 2 WATT  
POWER AMPLIFIER, 27.3 - 33.5 GHz**

**Output IM3 @ Vdd=5V**

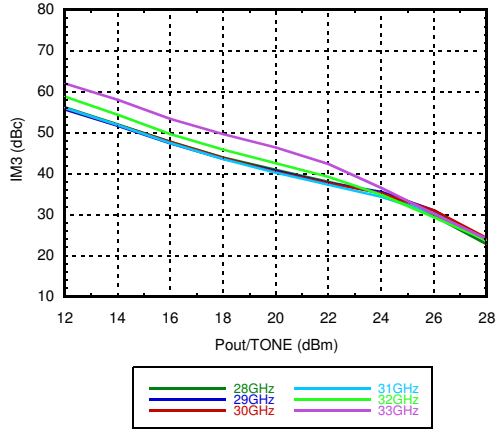

**Output IM3 @ Vdd=5.5V**

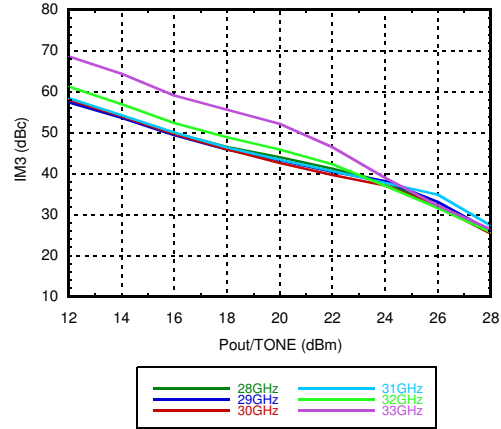

**Output IM3 @ Vdd=6V**

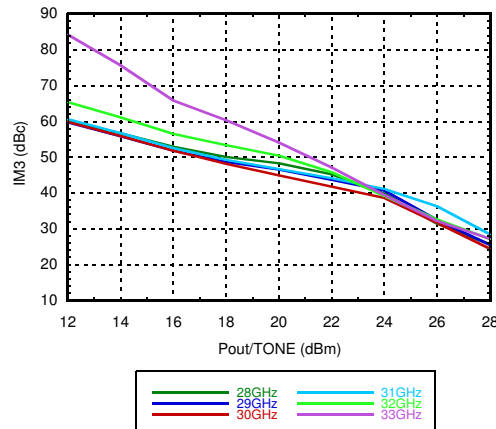

**Output IM3 @ Vdd=6.5V**

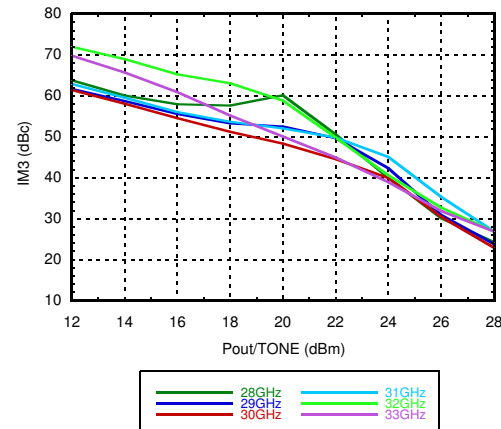

**I<sub>gg</sub> vs. Input Power**

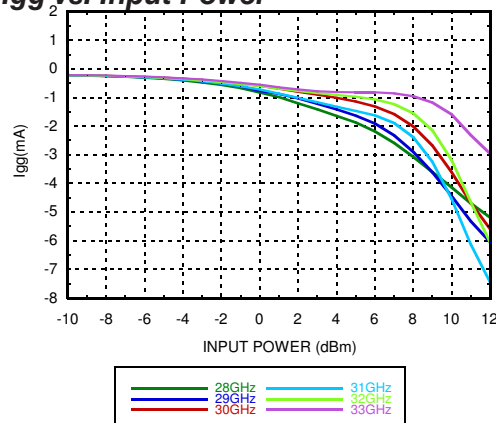

**I<sub>dd</sub> vs. V<sub>gg</sub>  
Representative of a Typical Device**

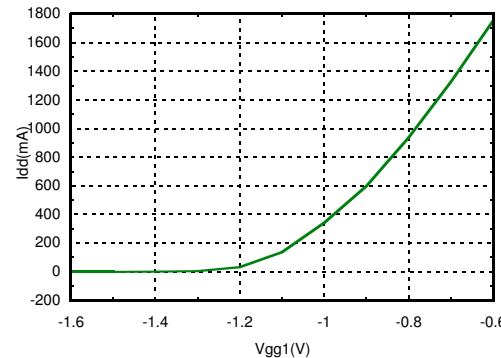

## GaAs pHEMT MMIC 2 WATT POWER AMPLIFIER, 27.3 - 33.5 GHz

### Absolute Maximum Ratings

Drain Bias Voltage (Vd)	+7V
RF Input Power (RFIN)	+20 dBm
Continuous P <sub>diss</sub> (T= 85 °C) (derate 146.4 mW/°C above 85 °C)	13.18 W
Storage Temperature	-65 to +150 °C
Operating Temperature	-55 to +85 °C
ESD Sensitivity (HBM)	Class 0B - Passed 150V

### Reliability Information

Channel Temperature	175 °C
Nominal Junction Temperature (T=85 °C, V <sub>dd</sub> = 10V)	134.2 °C
Thermal Resistance (channel to die bottom)	6.83 °C/W

Stresses at or above those listed in the Absolute Maximum Ratings may cause permanent damage to the product. This is a stress rating only, functional operation of the product at these or any other conditions above those indicated in the operational section of this specification is not implied. Operation beyond the maximum operating condition for extended periods may affect product reliability.



**ELECTROSTATIC SENSITIVE DEVICE  
OBSERVE HANDLING PRECAUTIONS**

## GaAs pHEMT MMIC 2 WATT POWER AMPLIFIER, 27.3 - 33.5 GHz

### Outline Drawing

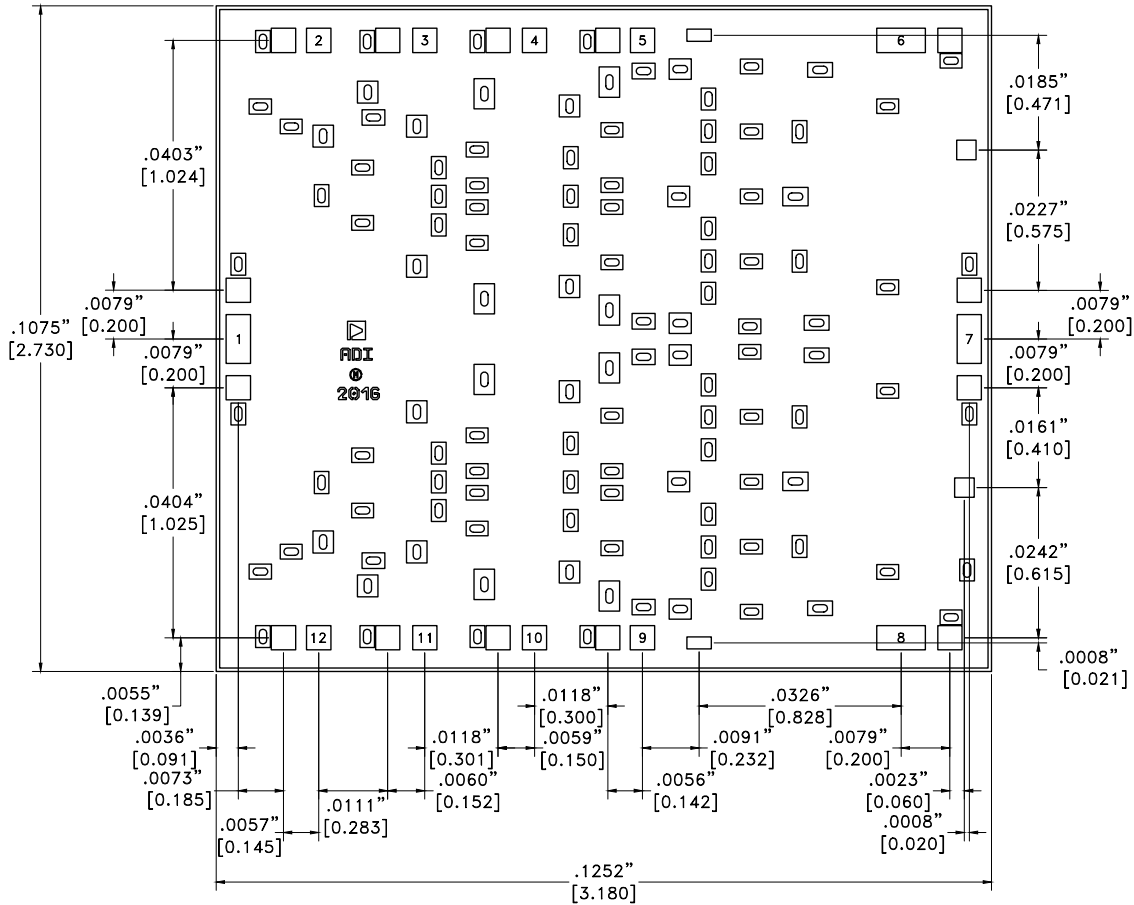

### Die Packaging Information <sup>[1]</sup>

Standard	Alternate
GP-1 (Gel Pack)	[2]

[1] Refer to the "Packaging Information" section on our website for die packaging dimensions.

[2] For alternate packaging information contact Analog Devices Inc.



#### NOTES:

1. ALL DIMENSIONS ARE IN INCHES [MM]
2. DIE THICKNESS IS .004"
3. TYPICAL BOND PAD IS .004" SQUARE
4. BACKSIDE METALLIZATION: GOLD
5. BOND PAD METALLIZATION: GOLD
6. BACKSIDE METAL IS GROUND.
7. CONNECTION NOT REQUIRED FOR UNLABELED BOND PADS.
8. OVERALL DIE SIZE  $\pm 0.002"$

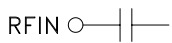
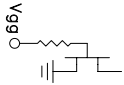
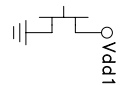
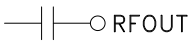
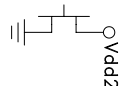

## GaAs pHEMT MMIC 2 WATT POWER AMPLIFIER, 27.3 - 33.5 GHz

### Pad Descriptions

Pad Number	Function	Description	Interface Schematic
1	RFIN	This pad is AC coupled and matched to 50 Ohms over the operating frequency range.	
2, 12	Vgg	Gate control for amplifier. External bypass caps 100 pF, 0.1 μF and 4.7 μF are required. Only one pad connection is required as these two pads are connected on-chip.	
3 - 6	Vdd1	Drain bias voltage for the top half of the amplifier. External bypass capacitors of 100 pF required for each pad, followed by common 0.1 μF and 4.7 μF are capacitors.	
7	RFOUT	. This pad is AC coupled and matched to 50 Ohms over the operating frequency range.	
8 - 11	Vdd2	Drain bias voltage for the lower half of the amplifier. External bypass capacitors of 100 pF required for each pad, followed by common 0.1 μF and 4.7 μF are capacitors.	
Die Bottom	GND	Die bottom must be connected to RF/DC ground.	

**GaAs pHEMT MMIC 2 WATT  
POWER AMPLIFIER, 27.3 - 33.5 GHz**

**Application Circuit**

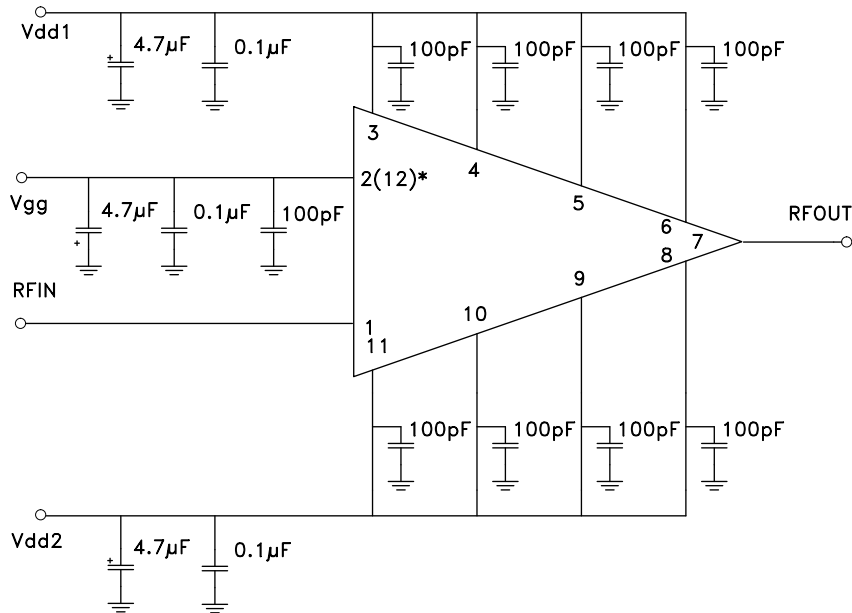

\*Vgg may be applied to either pad 2 or pad 12.

**Assembly Diagram <sup>[1]</sup>**

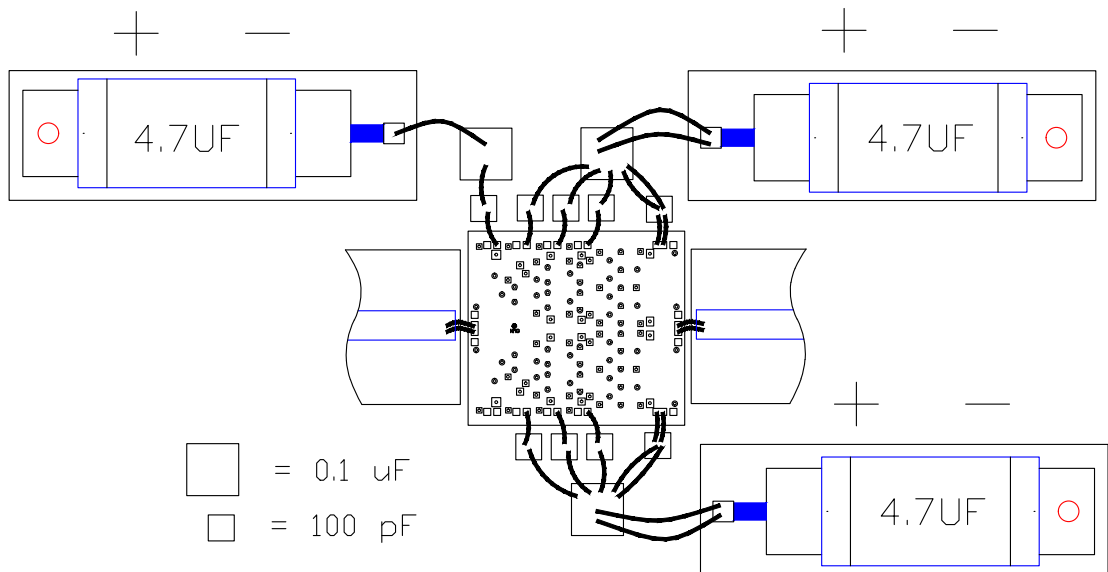

[1] Vgg may be applied to either pad 2 or pad 12.

## GaAs pHEMT MMIC 2 WATT POWER AMPLIFIER, 27.3 - 33.5 GHz

### Mounting & Bonding Techniques for Millimeterwave GaAs MMICs

The die should be attached directly to the ground plane eutectically or with conductive epoxy (see HMC general Handling, Mounting, Bonding Note).

50 Ohm Microstrip transmission lines on 0.127mm (5 mil) thick alumina thin film substrates are recommended for bringing RF to and from the chip (Figure 1). If 0.254mm (10 mil) thick alumina thin film substrates must be used, the die should be raised 0.150mm (6 mils) so that the surface of the die is coplanar with the surface of the substrate. One way to accomplish this is to attach the 0.102mm (4 mil) thick die to a 0.150mm (6 mil) thick molybdenum heat spreader (moly-tab) which is then attached to the ground plane (Figure 2).

Microstrip substrates should be placed as close to the die as possible in order to minimize bond wire length. Typical die-to-substrate spacing is 0.076mm to 0.152 mm (3 to 6 mils).

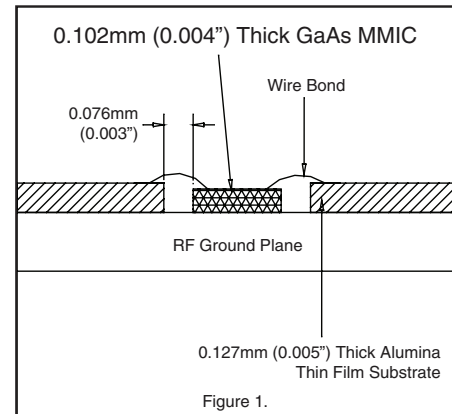

### Handling Precautions

Follow these precautions to avoid permanent damage.

**Storage:** All bare die are placed in either Waffle or Gel based ESD protective containers, and then sealed in an ESD protective bag for shipment. Once the sealed ESD protective bag has been opened, all die should be stored in a dry nitrogen environment.

**Cleanliness:** Handle the chips in a clean environment. DO NOT attempt to clean the chip using liquid cleaning systems.

**Static Sensitivity:** Follow ESD precautions to protect against ESD strikes.

**Transients:** Suppress instrument and bias supply transients while bias is applied. Use shielded signal and bias cables to minimize inductive pick-up.

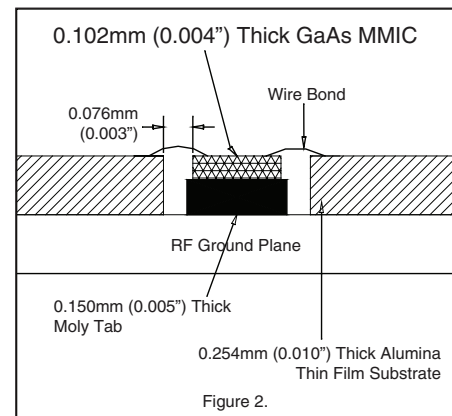

**General Handling:** Handle the chip along the edges with a vacuum collet or with a sharp pair of bent tweezers. The surface of the chip may have fragile air bridges and should not be touched with vacuum collet, tweezers, or fingers.

### Mounting

The chip is back-metallized and can be die mounted with AuSn eutectic preforms or with electrically conductive epoxy. The mounting surface should be clean and flat.

**Eutectic Die Attach:** A 80/20 gold tin preform is recommended with a work surface temperature of 255 °C and a tool temperature of 265 °C. When hot 90/10 nitrogen/hydrogen gas is applied, tool tip temperature should be 290 °C. DO NOT expose the chip to a temperature greater than 320 °C for more than 20 seconds. No more than 3 seconds of scrubbing should be required for attachment.

**Epoxy Die Attach:** Apply a minimum amount of epoxy to the mounting surface so that a thin epoxy fillet is observed around the perimeter of the chip once it is placed into position. Cure epoxy per the manufacturer's schedule.

### Wire Bonding

RF bonds made with two 1 mil wires are recommended. These bonds should be thermosonically bonded with a force of 40-60 grams. DC bonds of 0.001" (0.025 mm) diameter, thermosonically bonded, are recommended. Ball bonds should be made with a force of 40-50 grams and wedge bonds at 18-22 grams. All bonds should be made with a nominal stage temperature of 150 °C. A minimum amount of ultrasonic energy should be applied to achieve reliable bonds. All bonds should be as short as possible, less than 12 mils (0.31 mm).

---

**GaAs pHEMT MMIC 2 WATT  
POWER AMPLIFIER, 27.3 - 33.5 GHz**

**Notes:**

## X-ON Electronics

Largest Supplier of Electrical and Electronic Components

*Click to view similar products for [RF Amplifier](#) category:*

*Click to view products by [Analog Devices](#) manufacturer:*

Other Similar products are found below :

[A82-1](#) [BGA622H6820XTSA1](#) [BGA 728L7 E6327](#) [BGB719N7ESDE6327XTMA1](#) [HMC397-SX](#) [HMC405](#) [HMC561-SX](#) [HMC8120-SX](#)  
[HMC8121-SX](#) [HMC-ALH382-SX](#) [HMC-ALH476-SX](#) [SE2433T-R](#) [SMA3101-TL-E](#) [SMA39](#) [A66-1](#) [A66-3](#) [A67-1](#) [A81-2](#) [LX5535LQ](#)  
[LX5540LL](#) [MAAM02350](#) [HMC3653LP3BETR](#) [HMC549MS8GETR](#) [HMC-ALH435-SX](#) [SMA101](#) [SMA32](#) [SMA411](#) [SMA531](#)  
[SST12LP19E-QX6E](#) [WPM0510A](#) [HMC5929LS6TR](#) [HMC5879LS7TR](#) [HMC1087F10](#) [HMC1086](#) [HMC1016](#) [SMA1212](#) [MAX2689EWS+T](#)  
[MAAMSS0041TR](#) [MAAM37000-A1G](#) [LTC6430AIUF-15#PBF](#) [SMA70-2](#) [SMA4011](#) [A231](#) [HMC-AUH232](#) [LX5511LQ](#) [LX5511LQ-TR](#)  
[HMC7441-SX](#) [HMC-ALH310](#) [XD1001-BD-000V](#) [A4011](#)