

GaAs MMIC 6 BIT DIGITAL PHASE SHIFTERS, 1.2 - 1.4 GHz

Typical Applications

The HMC936ALP6E is ideal for:

- EW Receivers
- Weather & Military Radar
- Satellite Communications
- Beamforming Modules
- Phase Cancellation

Functional Diagram

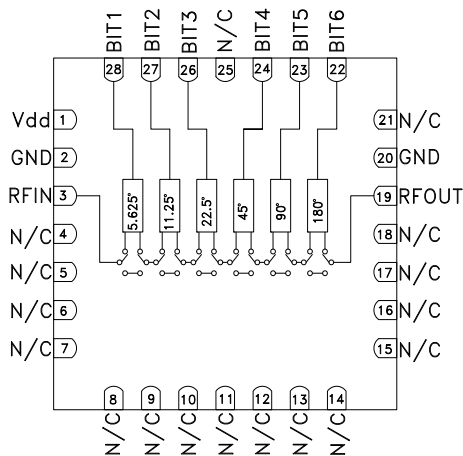

Features

- Low RMS Phase Error: 1.2°
- Low Insertion Loss: 5 dB
- High Linearity: +45 dBm
- Positive Control Logic
- 360° Coverage, LSB = 5.625°
- 28 Lead 6x6mm SMT Package: 36mm²

General Description

The HMC936ALP6E is a 6-bit digital phase shifter which is rated from 1.2 to 1.4 GHz, providing 360 degrees of phase coverage, with a LSB of 5.625 degrees. The HMC936ALP6E features very low RMS phase error of 1.2 degrees and extremely low insertion loss variation of ± 0.5 dB across all phase states. This high accuracy phase shifter is controlled with positive control logic of 0/+5V and requires no negative supply voltage. The HMC936ALP6E is housed in a compact 6x6 mm plastic leadless SMT package and is internally matched to 50 Ohms with no external components.

Electrical Specifications

$T_A = +25^\circ \text{C}$, $V_{dd} = +5\text{V}$, Control Voltage = 0/ +5V, 50 Ohm System

Parameter	Min.	Typ.	Max.	Units
Frequency Range	1.2		1.4	GHz
Insertion Loss		5	7	dB
Input Return Loss		16		dB
Output Return Loss		17		dB
Phase Error		± 5	± 10	deg
RMS Phase Error		1.2		deg
Amplitude Settling Time (50% cntl to +/- 0.1dB margin of final RFout)		225		nS
Phase Settling Time (50% cntl to +/-1 degree margin of final RFout)		175		nS
Insertion Loss Variation		± 0.5		dB
Input Power for 1 dB Compression		29		dBm
Input Third Order Intercept		45		dBm
Control Voltage Current		35	100	μA
Bias Control Current		3	8	mA
Switching Time (50% Vctl to 90% RF Amplitude)		250		ns

**GaAs MMIC 6 BIT DIGITAL
PHASE SHIFTERS, 1.2 - 1.4 GHz**

Insertion Loss, Major States Only

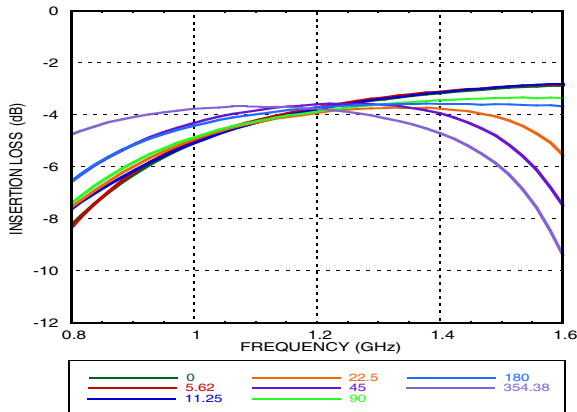

Normalized Loss, Major States Only

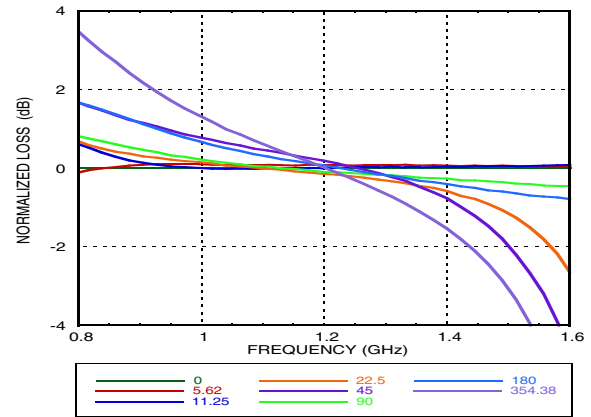

Input Return Loss, Major States Only



Phase Error, Major States Only

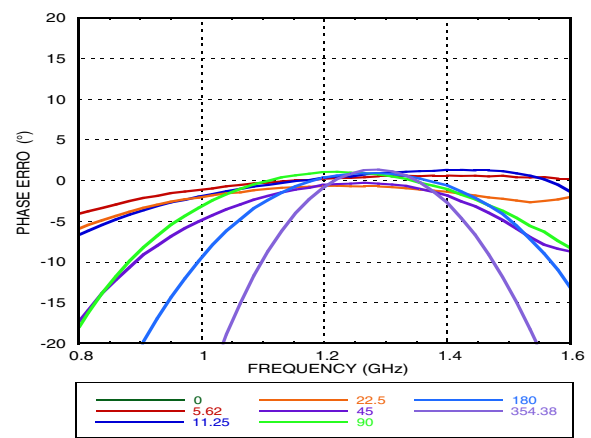

Output Return Loss, Major States Only

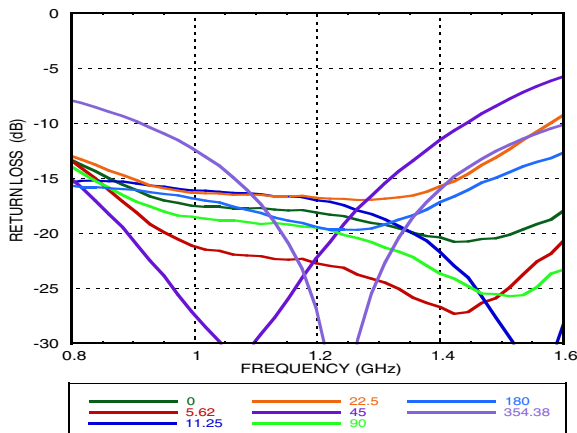

**Relative Phase Shift
Major States Including All Bits**

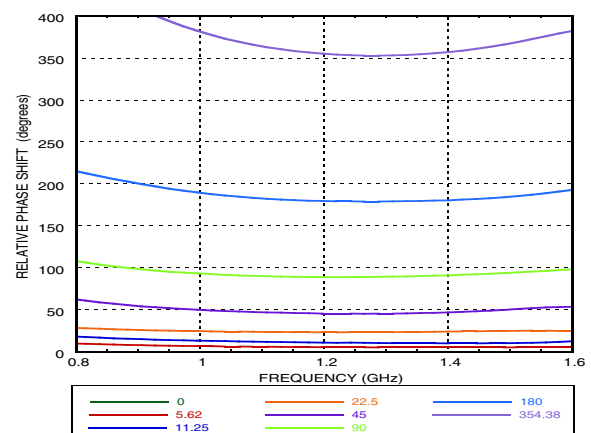

**GaAs MMIC 6 BIT DIGITAL
PHASE SHIFTERS, 1.2 - 1.4 GHz**

**Relative Phase Shift,
RMS, Average, Max, All States**

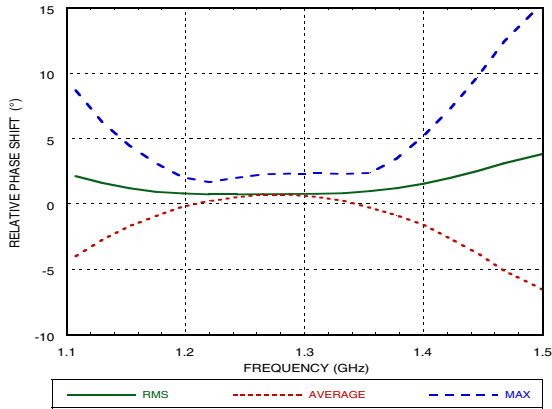

Input IP3, Major States Only

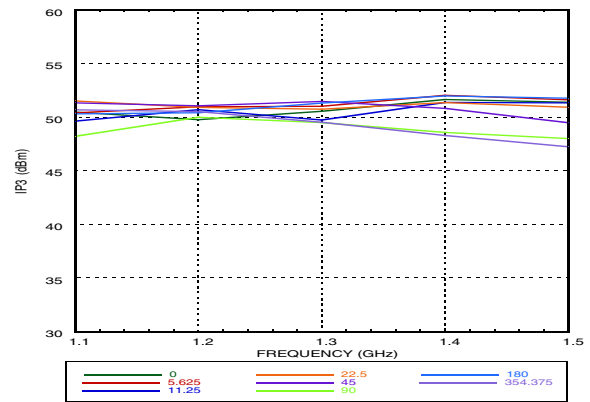

Input IP2, Major States Only

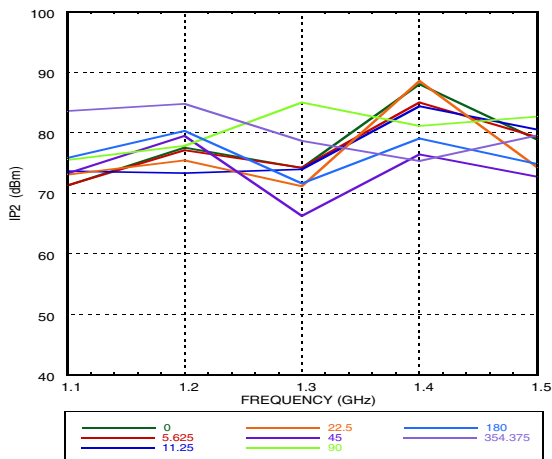

Input P1dB, Major States Only

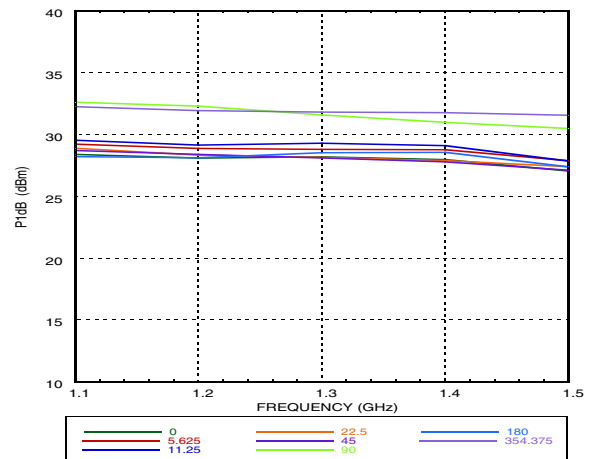

RMS Phase Error vs. Temperature

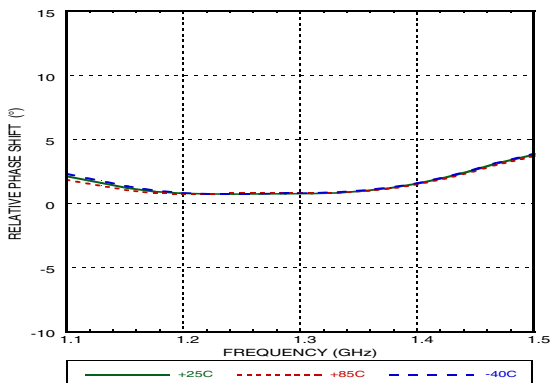

**Insertion Loss vs. Temperature,
Major States Only**

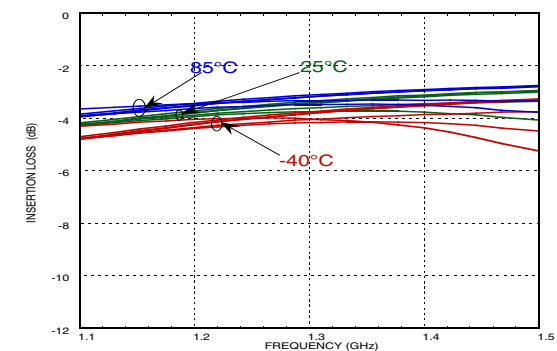

GaAs MMIC 6 BIT DIGITAL PHASE SHIFTERS, 1.2 - 1.4 GHz

Phase Error vs. State

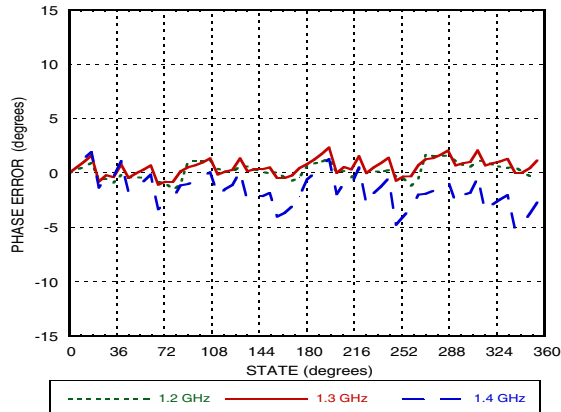

Absolute Maximum Ratings

Input Power (RFIN)	33 dBm (T= +85 °C)
Bias Voltage Range (Vdd)	-0.2 to +12V
Channel Temperature (Tc)	150 °C
Thermal Resistance (channel to ground paddle)	100 °C/W
Storage Temperature	-65 to +150 °C
Operating Temperature	-40 to +85 °C
ESD Sensitivity (HBM)	Class 1A



**ELECTROSTATIC SENSITIVE DEVICE
OBSERVE HANDLING PRECAUTIONS**

Bias Voltage & Current

Vdd	Idd
5.0	3 mA

Control Voltage

State	Bias Condition
Low (0)	0 to 0.2 Vdc
High (1)	Vdd ±0.2 Vdc @ 35 µA Typ.

Truth Table

Control Voltage Input						Phase Shift (Degrees) RFIN - RFOUT
Bit 1	Bit 2	Bit 3	Bit 4	Bit 5	Bit 6	
1	1	1	1	1	1	Reference*
0	1	1	1	1	1	5.625
1	0	1	1	1	1	11.25
1	1	0	1	1	1	22.5
1	1	1	0	1	1	45.0
1	1	1	1	0	1	90.0
1	1	1	1	1	0	180.0
0	0	0	0	0	0	354.375

Any combination of the above states will provide a phase shift approximately equal to the sum of the bits selected.

*Reference corresponds to monotonic setting

GaAs MMIC 6 BIT DIGITAL PHASE SHIFTERS, 1.2 - 1.4 GHz

Outline Drawing

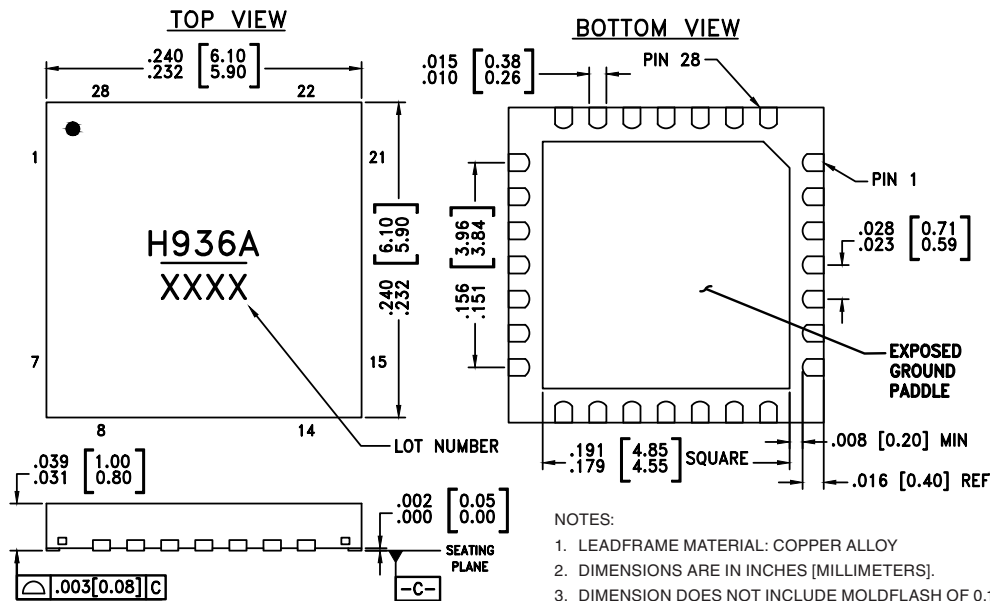

NOTES:

- LEADFRAME MATERIAL: COPPER ALLOY
- DIMENSIONS ARE IN INCHES [MILLIMETERS].
- DIMENSION DOES NOT INCLUDE MOLDFLASH OF 0.15mm PER SIDE.
- DIMENSION DOES NOT INCLUDE MOLDFLASH OF 0.25mm PER SIDE.
- ALL GROUND LEADS MUST BE SOLDERED TO PCB RF GROUND.
- CLASSIFIED AS MOISTURE SENSITIVITY LEVEL (MSL) 1.

Package Information

Part Number	Package Body Material	Lead Finish	MSL Rating	Package Marking ^[1]
HMC936ALP6E	RoHS-compliant Low Stress Injection Molded Plastic	100% matte Sn	MSL3 ^[2]	H936 XXXX

[2] Max peak reflow temperature of 260 °C

[1] 4-Digit lot number XXXX

Pin Descriptions

Pin Number	Function	Description	Interface Schematic
1	Vdd	Voltage supply.	
2, 20	GND	These pins and exposed ground paddle must be connected to RF/DC ground.	
3	RFIN	This port is DC coupled and matched to 50 Ohms.	
4 - 18, 21, 25	N/C	The pins are not connected internally; however, all data shown herein was measured with these pins connected to RF/DC ground externally.	
19	RFOUT	This port is DC coupled and matched to 50 Ohms.	
22 - 24, 26 - 28	BIT6, BIT5, BIT4, BIT3, BIT2, BIT1	Control Input. See truth table and control voltage tables.	

GaAs MMIC 6 BIT DIGITAL PHASE SHIFTERS, 1.2 - 1.4 GHz

Evaluation PCB

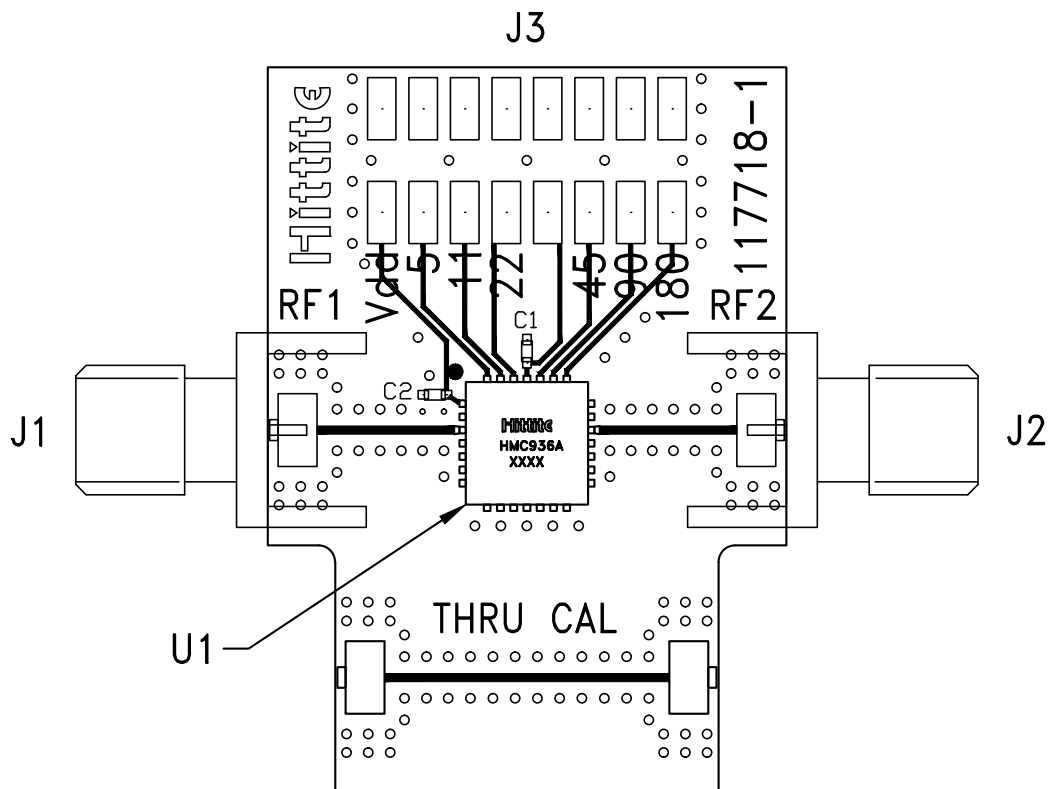

List of Materials for Evaluation PCB EV1HMC936ALP6 ^{[1][3]}

Item	Description
J1 - J2	PCB Mount SMA RF Connector
J3	Header 2mm, 16 Pin
C1, C2	1000 pF Capacitor, 0402 Pkg.
U1	HMC936ALP6E 6-Bit Digital Phase Shifter
PCB [2]	117718 Evaluation PCB

[1] Reference this number when ordering complete evaluation PCB

[2] Circuit Board Material: Rogers 4350

[3] Please refer to part's pin description and functional diagram for pin out assignments on evaluation board.

The circuit board used in the application should use RF circuit design techniques. Signal lines should have 50 ohm impedance while the package ground leads and exposed paddle should be connected directly to the ground plane similar to that shown. A sufficient number of via holes should be used to connect the top and bottom ground planes. The evaluation board should be mounted to an appropriate heat sink. The evaluation circuit board shown is available from Analog Devices upon request.

X-ON Electronics

Largest Supplier of Electrical and Electronic Components

Click to view similar products for [Phase Detectors/Shifters](#) category:

Click to view products by [Analog Devices](#) manufacturer:

Other Similar products are found below :

[TGP2100](#) [MAPS-010163-TR1000](#) [HMC933LP4ETR](#) [HMC934LP5ETR](#) [HMC647LP6ETR](#) [HMC3716LP4ETR](#) [MAPS-010166-001SMB](#)
[HMC247-SX](#) [HMC543ALC4B](#) [HMC642ALC5](#) [HMC648ALP6E](#) [HMC936ALP6E](#) [HMC984LP4E](#) [MAPS-010146-TR0500](#) [MAPS-010163-001SMB](#) [MAPS-010163-TR0500](#) [MAPS-010164-TR0500](#) [MAPS-010166-TR0500](#) [HMC642ALC5TR](#) [HMC649ALP6E](#) [HMC984LP4ETR](#)
[MAPS-010143-TR0500](#) [HMC649ALP6ETR](#) [MC100EP140DG](#) [MC100LVEL40DWG](#) [PE44820B-X](#) [CHP3015-QDG](#) [CMD176P4](#) [QPC2108](#)
[HMC644ALC5](#) [MAPS-010145-TR0500](#) [MAPS-010144-TR0500](#) [TGP2615-SM](#) [TGP2108-SM](#) [MAPS-010143-001SMB](#) [MAPS-010144-001SMB](#) [MAPS-010145-001SMB](#) [MAPS-010146-001SMB](#) [MAPS-010164-001SMB](#) [HMC644ALC5TR](#) [MC100LVEL40DWR2G](#) [TGP2107-SM](#) [TGP2107](#) [TGP2109](#) [TGP2109-SM](#)