

GaAs pHEMT MMIC 2 Watt POWER AMPLIFIER WITH POWER DETECTOR 8 - 14 GHz

Typical Applications

The HMC952ALP5GE is ideal for:

- Point-to-Point Radios
- Point-to-Multi-Point Radios
- SATCOM

Features

- +35 dBm Psat @ 26% PAE
- High P1dB Output Power: +34 dBm
- High Gain: 32 dB
- High Output IP3: +43 dBm
- Supply Voltage: Vdd = +6V @ 1400 mA
- 50 Ohm Matched Input/Output

Functional Diagram

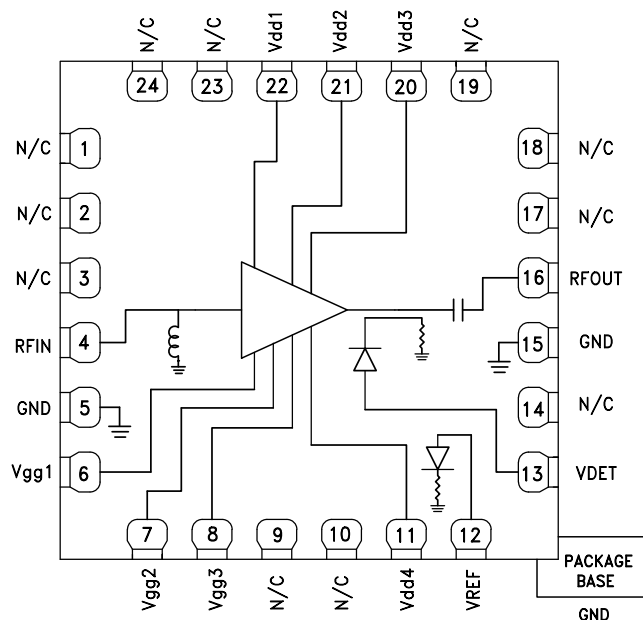

General Description

The HMC952ALP5GE is a four-stage GaAs pHEMT MMIC Medium Power Amplifier with a temperature compensated on-chip power detector which operates between 8 and 14 GHz. The amplifier provides 32 dB of gain and +34.5 dBm of saturated output power at 26% PAE from a +6V supply. With up to +43 dBm IP3 the HMC952ALP5GE is ideal for linear applications such as point-to-point and point-to-multi-point radios or SATCOM applications demanding +34.5dBm of efficient saturated output power. The RF I/Os are internally matched to 50 Ohms.

Electrical Specifications, $T_A = +25^\circ C$, Vdd1, Vdd2, Vdd3, Vdd4 = +6V, Idd = 1400 mA [1]

Parameter	Min.	Typ.	Max.	Min.	Typ.	Max.	Min.	Typ.	Max.	Units
Frequency Range		8 - 9		9 - 13			13 - 14			GHz
Gain	28.5	31		30	32		28	30.5		dB
Gain Variation Over Temperature		0.02			0.02			0.02		dB/ °C
Input Return Loss		17			17			24		dB
Output Return Loss		15			13			14		dB
Output Power for 1 dB Compression (P1dB)	31	33		31	33		32	34		dBm
Saturated Output Power (Psat)		34.5			35			35		dBm
Output Third Order Intercept (IP3) [2]		43			43			43		dBm
Total Supply Current		1400			1400			1400		mA

[1] Adjust Vgg between -2 to 0V to achieve Idd = 1400 mA typical.

[2] Measurement taken at Pout / tone = +20 dBm.

GaAs pHEMT MMIC 2 Watt POWER AMPLIFIER WITH POWER DETECTOR 8 - 14 GHz

Gain & Return Loss

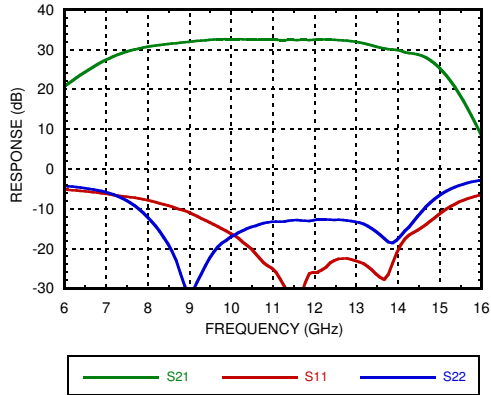

Gain vs. Temperature

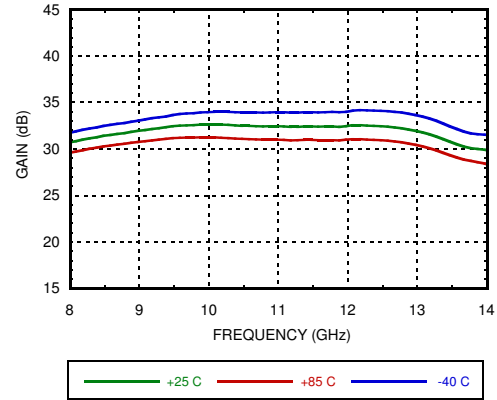

Input Return Loss vs. Temperature

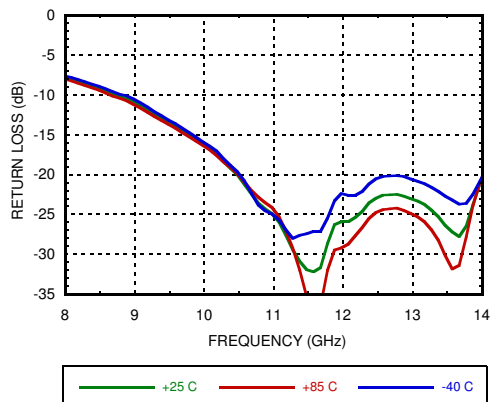

Output Return Loss vs. Temperature

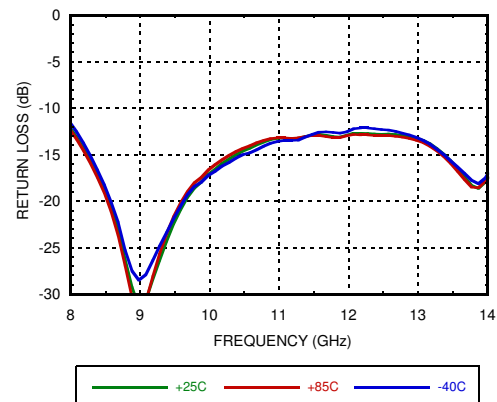

P1dB vs. Temperature

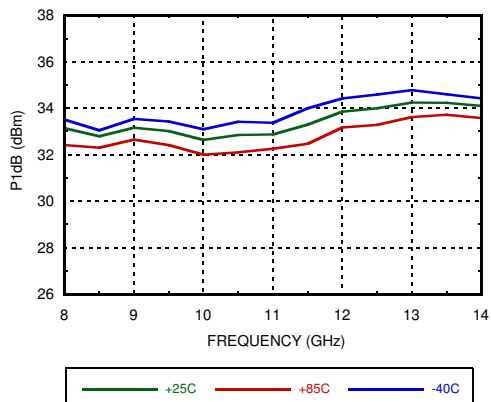

P1dB vs. Supply Voltage

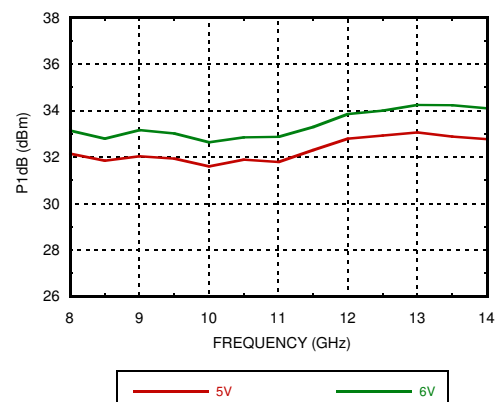

GaAs pHEMT MMIC 2 Watt POWER AMPLIFIER WITH POWER DETECTOR 8 - 14 GHz

Psat vs. Temperature

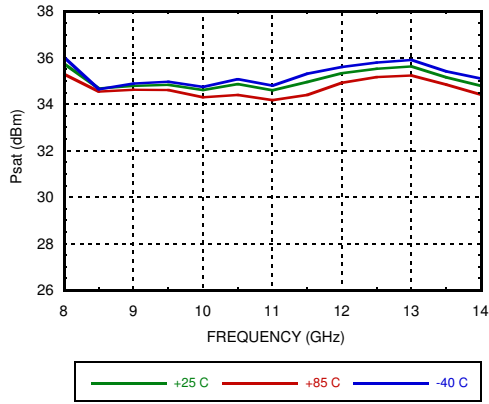

Psat vs. Supply Voltage

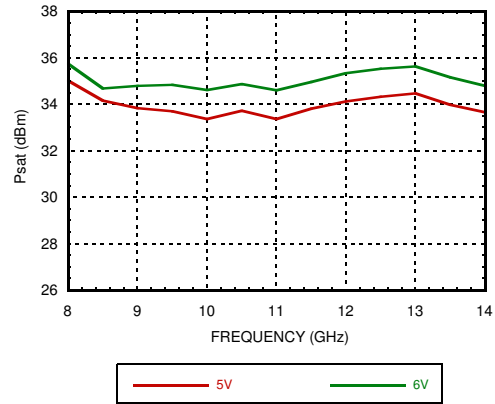

P1dB vs. Supply Current

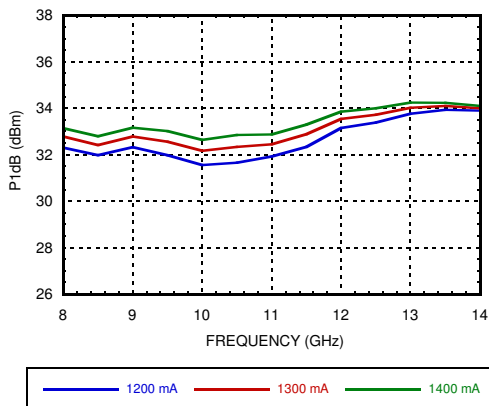

Psat vs. Supply Current

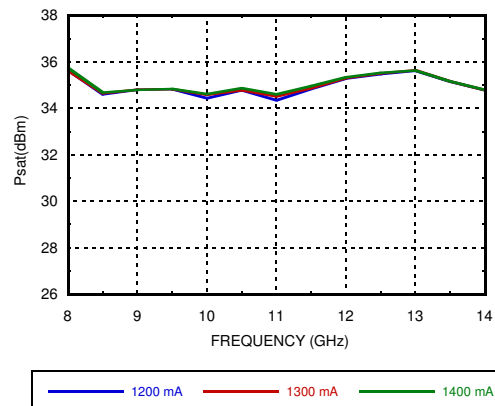

Output IP3 vs. Temperature, Pout/tone = +20 dBm

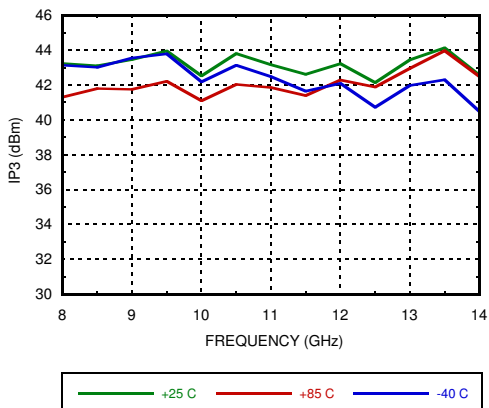

Output IP3 vs. Supply Current, Pout/tone = +20 dBm

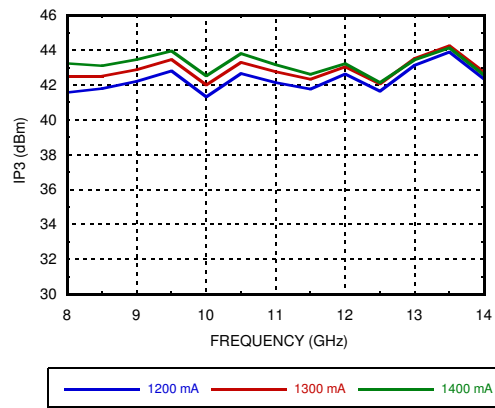

GaAs pHEMT MMIC 2 Watt POWER AMPLIFIER WITH POWER DETECTOR 8 - 14 GHz

Output IP3 vs. Supply Voltage, Pout/tone = +20 dBm

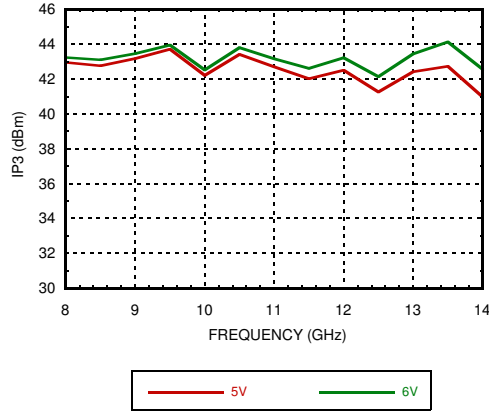

Output IM3 @ Vdd = +5V

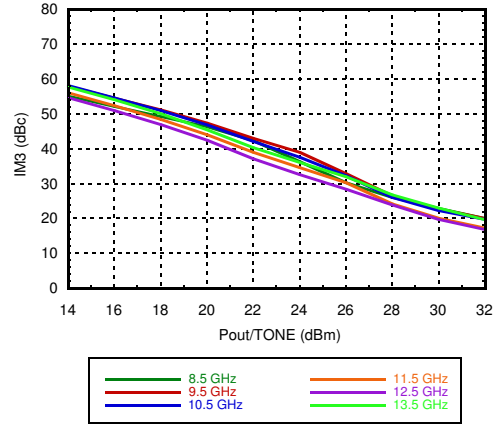

Output IM3 @ Vdd = +6V

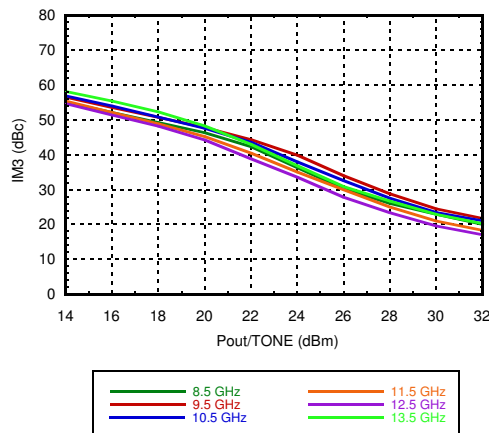

Power Compression @ 8.5 GHz

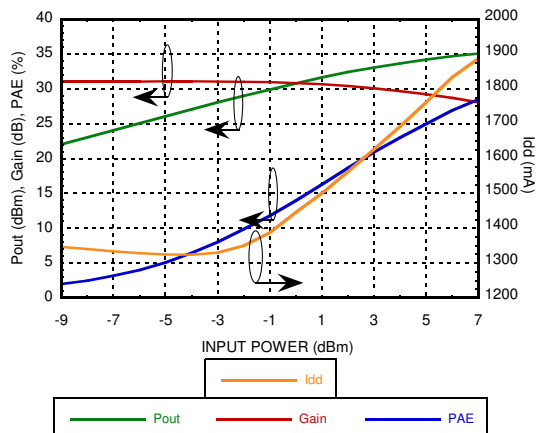

Power Compression @ 11 GHz

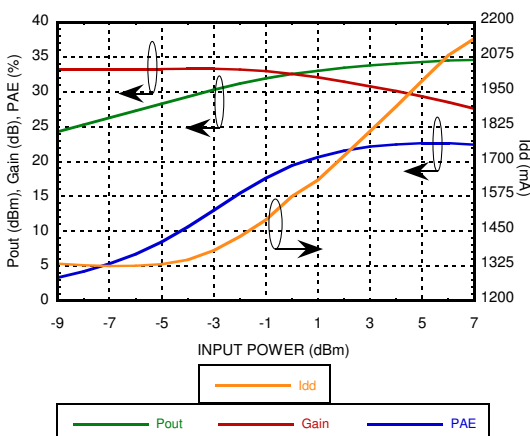

Power Compression @ 13.5 GHz

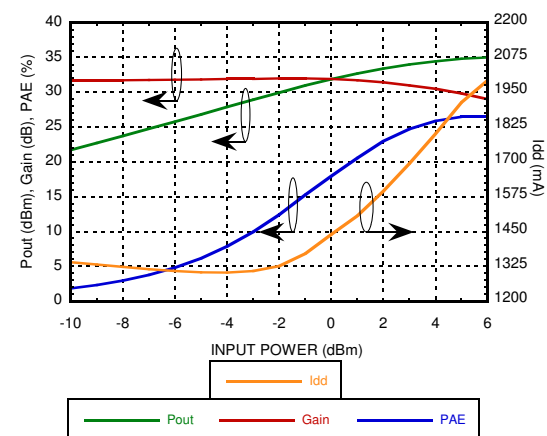

GaAs pHEMT MMIC 2 Watt POWER AMPLIFIER WITH POWER DETECTOR 8 - 14 GHz

Detector Voltage vs. Frequency & Temperature

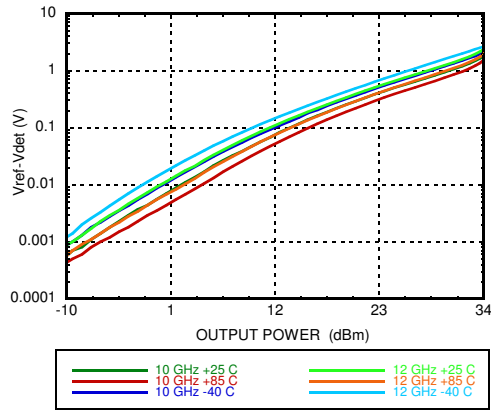

Reverse Isolation vs. Temperature

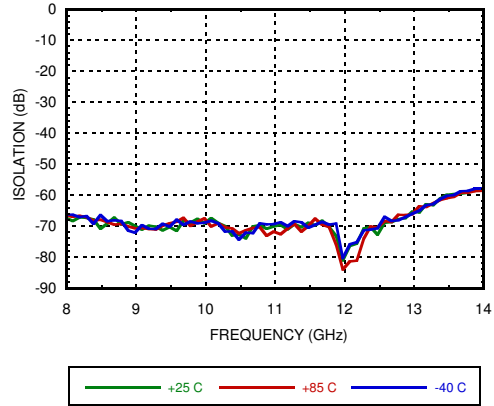

Gain & Power vs. Supply Current @ 11.5 GHz

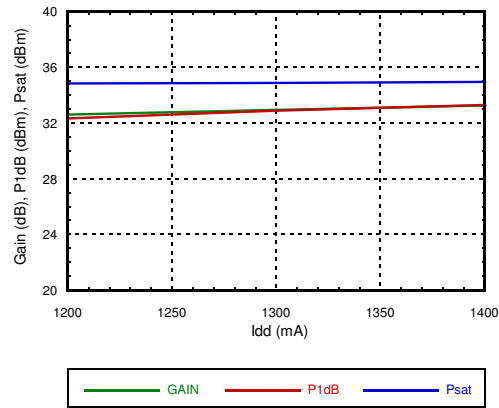

Gain & Power vs. Supply Voltage @ 11.5 GHz

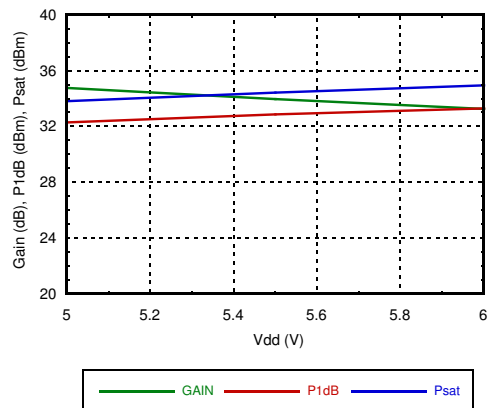

Power Dissipation

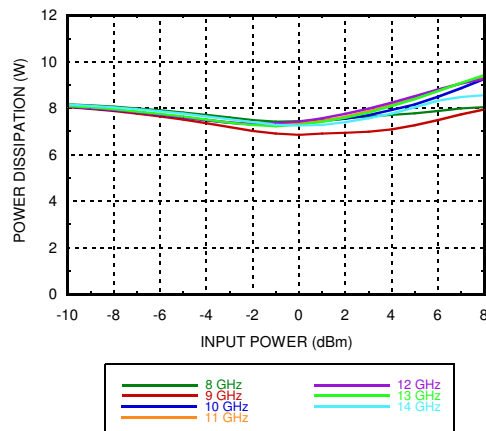

GaAs pHEMT MMIC 2 Watt POWER AMPLIFIER WITH POWER DETECTOR 8 - 14 GHz

Absolute Maximum Ratings

Drain Bias Voltage (Vdd)	+6.5 Vdc
Gate Bias Voltage (Vgg)	-3 - 0 Vdc
RF Input Power (RFIN)	24 dBm
Channel Temperature	175 °C
Continuous Pdiss (T= 85 °C) (derate 137 mW/°C above 85 °C)	10 W
Thermal Resistance (channel to die bottom)	9 °C/W
Storage Temperature	-65 to 150°C
Operating Temperature	-55 to 85 °C
ESD Sensitivity (HBM)	Class 0

Typical Supply Current vs. Vdd

Vdd (V)	Idd (mA)
+5	1400
+6	1400

Adjust Vgg1 = Vgg2 = Vgg3 to achieve Idd = 1400 mA



ELECTROSTATIC SENSITIVE DEVICE
OBSERVE HANDLING PRECAUTIONS

Outline Drawing

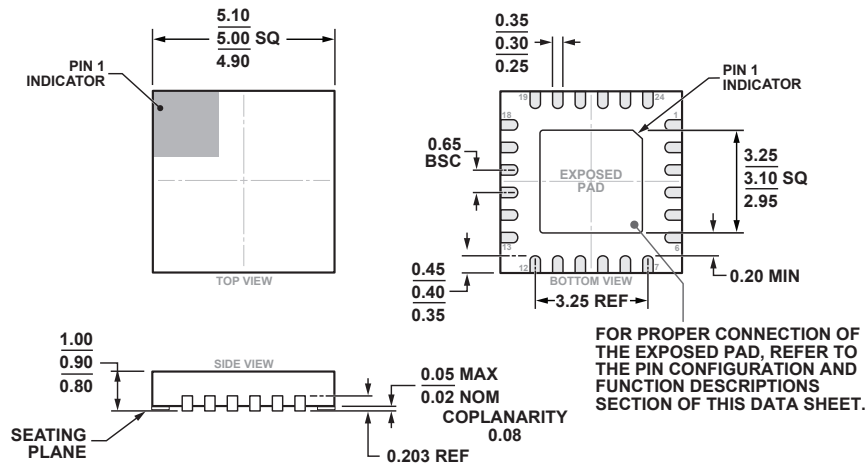

COMPLIANT TO JEDEC STANDARDS MO-220-VHHC-1.

24-Lead Lead Frame Chip Scale Package [LFCSP]
5 mm × 5 mm Body and 0.90 mm Package Height
(CP-24-20)

Dimensions shown in millimeters.



Package Information

Part Number	Package Body Material	Lead Finish	MSL Rating [2]	Package Marking [1]
HMC952ALP5GE	RoHS-compliant Low Stress Injection Molded Plastic	100% matte Sn	MSL3	H952A XXXX

[1] 4-Digit lot number XXXX

[2] Max peak reflow temperature of 260 °C

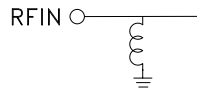
**GaAs pHEMT MMIC 2 Watt POWER AMPLIFIER
WITH POWER DETECTOR 8 - 14 GHz**
Pin Descriptions

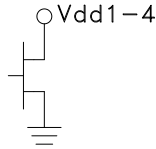
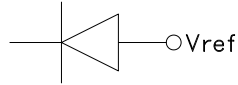
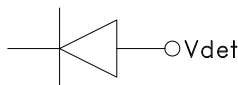
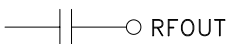
Pin Number	Function	Description	Interface Schematic
1-3, 9, 10, 14, 17-19, 23, 24	N/C	These pins are not connected internally, however all data shown herein was measured with these pins connected to RF/DC ground externally.	
4	RFIN	This pin is DC coupled and matched to 50 Ohms.	
5, 15	GND	These pins and package bottom must be connected to RF/DC ground.	
6-8	Vgg1, Vgg2, Vgg3	Gate control for amplifier External bypass capacitors of 100pF, 10nF and 4.7uF are required.	
11, 20-22	Vdd4, Vdd3, Vdd2, Vdd1	Drain bias voltage for amplifier. external bypass capacitors of 100pF, 10nF and 4.7uF are required.	
12	Vref	DC bias of diode biased through external resistor , used for temperature compensation of Vdet. See application circuit.	
13	Vdet	DC voltage representing RF output power rectified by diode which is biased through an external resistor. See application circuit.	
16	RFOUT	This pin is AC coupled and matched to 50 Ohms	

**GaAs pHEMT MMIC 2 Watt POWER AMPLIFIER
WITH POWER DETECTOR 8 - 14 GHz**

Application Circuit

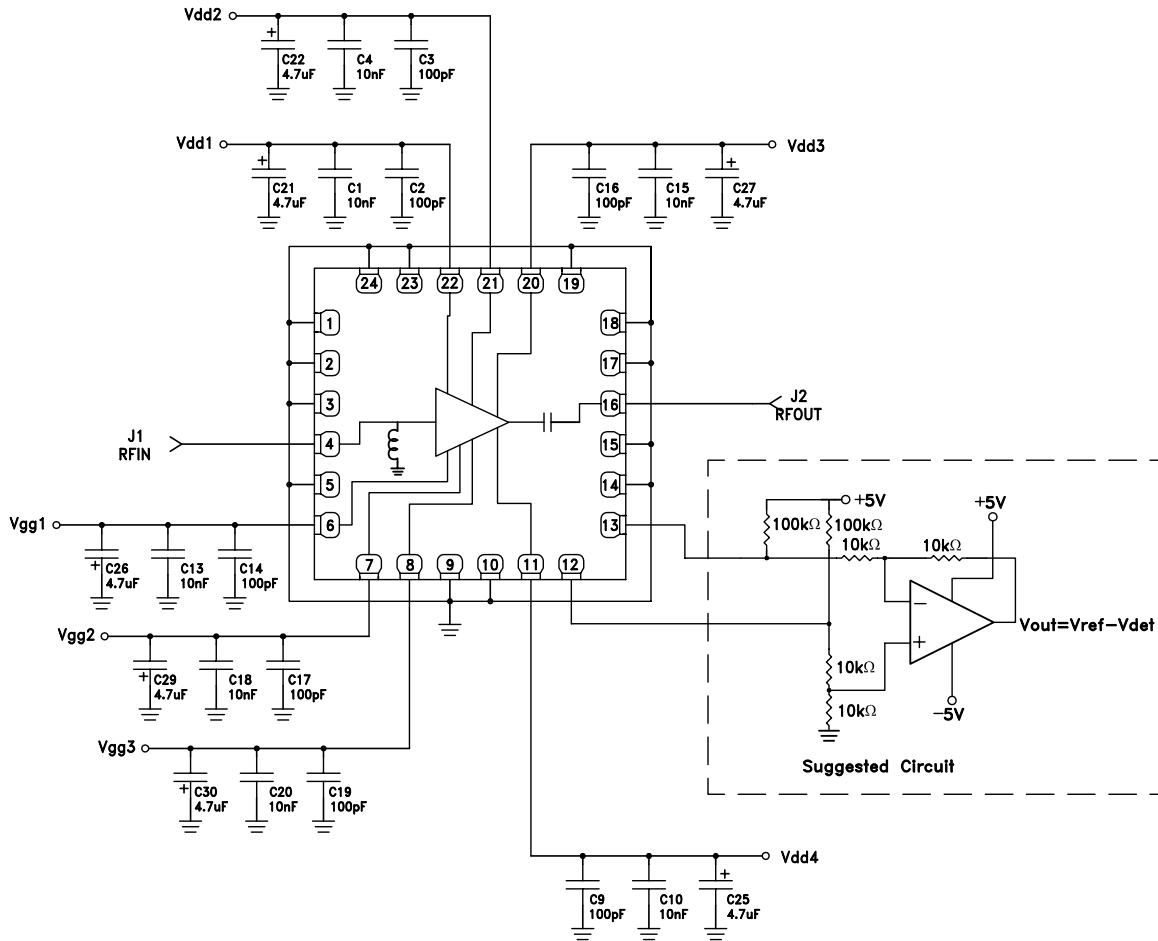

GaAs pHEMT MMIC 2 Watt POWER AMPLIFIER WITH POWER DETECTOR 8 - 14 GHz

Evaluation PCB

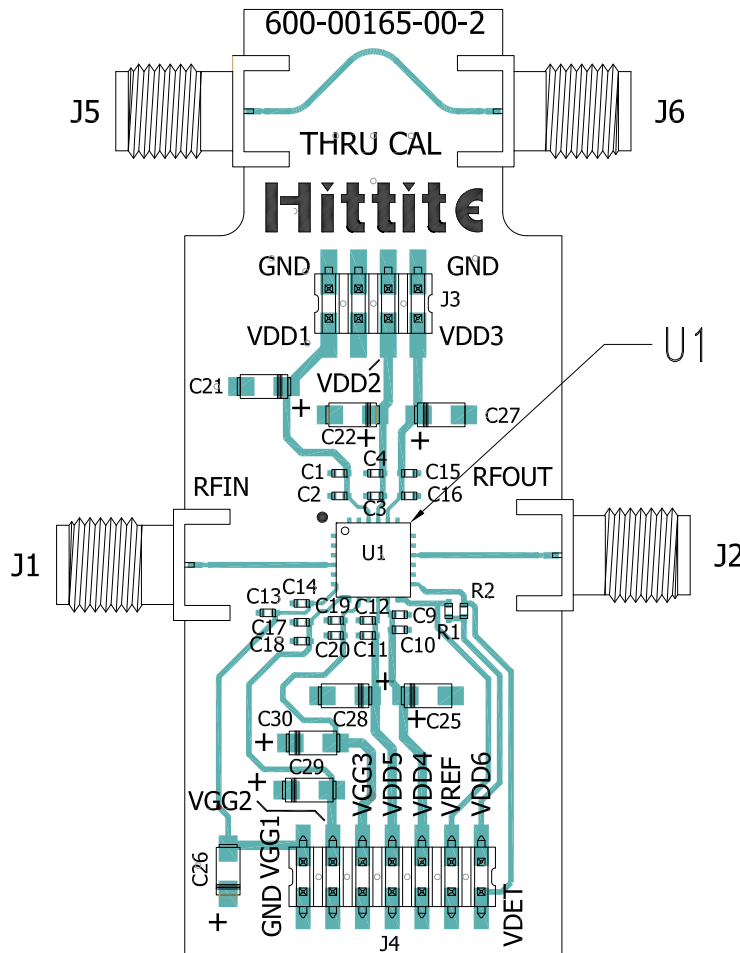

List of Materials for Evaluation PCB EV1HMC952ALP5G ^[1]

Item	Description
J1, J2, J5, J6	K Connector SRI
J3, J4	DC Pin
C2, C3, C9, C12, C14, C16, C17, C19	100 pF Capacitor, 0402 Pkg.
C1, C4, C10, C11, C13, C15, C18, C20	10 nF Capacitor, 0402 Pkg.
C21, C22, C25 - C30	4.7uF Capacitor, Case A.
U1	HMC952ALP5GE Power Amplifier
PCB	600-00163-00 Evaluation PCB

[1] Reference this number when ordering complete evaluation PCB

[2] Circuit Board Material: Rogers 4350 or Arlon FR4

The circuit board used in the application should use RF circuit design techniques. Signal lines should have 50 Ohm impedance while the package ground leads and exposed paddle should be connected directly to the ground plane similar to that shown. A sufficient number of via holes should be used to connect the top and bottom ground planes. The evaluation circuit board shown is available from Analog Devices, upon request.

**GaAs pHEMT MMIC 2 Watt POWER AMPLIFIER
WITH POWER DETECTOR 8 - 14 GHz**

Notes:

X-ON Electronics

Largest Supplier of Electrical and Electronic Components

Click to view similar products for [RF Amplifier](#) category:

Click to view products by [Analog Devices](#) manufacturer:

Other Similar products are found below :

[A82-1](#) [BGA622H6820XTSA1](#) [BGA 728L7 E6327](#) [BGB719N7ESDE6327XTMA1](#) [HMC397-SX](#) [HMC405](#) [HMC561-SX](#) [HMC8120-SX](#)
[HMC8121-SX](#) [HMC-ALH382-SX](#) [HMC-ALH476-SX](#) [SE2433T-R](#) [SMA3101-TL-E](#) [SMA39](#) [A66-1](#) [A66-3](#) [A67-1](#) [A81-2](#) [LX5535LQ](#)
[LX5540LL](#) [MAAM02350](#) [HMC3653LP3BETR](#) [HMC549MS8GETR](#) [HMC-ALH435-SX](#) [SMA101](#) [SMA32](#) [SMA411](#) [SMA531](#)
[SST12LP19E-QX6E](#) [WPM0510A](#) [HMC5929LS6TR](#) [HMC5879LS7TR](#) [HMC1087F10](#) [HMC1086](#) [HMC1016](#) [SMA1212](#) [MAX2689EWS+T](#)
[MAAMSS0041TR](#) [MAAM37000-A1G](#) [LTC6430AIUF-15#PBF](#) [SMA70-2](#) [SMA4011](#) [A231](#) [HMC-AUH232](#) [LX5511LQ](#) [LX5511LQ-TR](#)
[HMC7441-SX](#) [HMC-ALH310](#) [XD1001-BD-000V](#) [A4011](#)