



Typical Applications

The HMC-C001 Wideband LNA is ideal for:

- Telecom Infrastructure
- Microwave Radio & VSAT
- Military & Space
- Test Instrumentation
- Fiber Optics

Functional Diagram

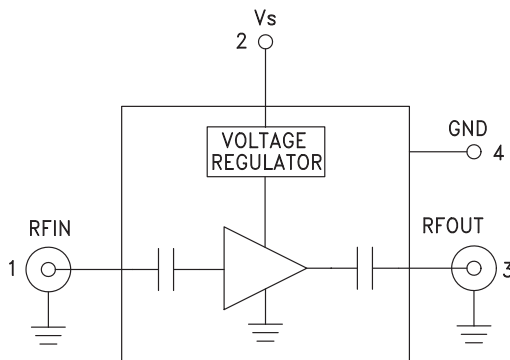

Features

Noise Figure: 2 dB @ 10 GHz

Flat Gain: 15 dB ± 0.5 dB

P1dB Output Power: +14 dBm @ 10 GHz

50 Ohm Matched Input/Output

Regulated Supply + 9V to +15V @ 65mA

Hermetically Sealed Module

Field Replaceable SMA connectors

-55 to +85°C Operating Temperature

General Description

The HMC-C001 is a GaAs MMIC PHEMT Low Noise Distributed Amplifier in a miniature, hermetic module with replaceable SMA connectors which operates between 2 and 20 GHz. The self-biased amplifier provides 15 dB of gain, 2 to 3 dB noise figure and +14 dBm of output power at 1 dB gain compression while requiring a single +12V supply. Gain flatness is excellent from 2 - 18 GHz making the HMC-C001 ideal for EW, ECM RADAR and test equipment applications. The wideband amplifier I/Os are internally matched to 50 Ohms and are internally DC blocked.

Electrical Specifications, $T_A = +25^\circ\text{C}$, $V_s = +9\text{V to } +15\text{V}$

Parameter	Min.	Typ.	Max.	Min.	Typ.	Max.	Min.	Typ.	Max.	Units
Frequency Range	2.0 - 6.0			6.0 - 16.0			16.0 - 20.0			GHz
Gain	13	15		12	14.5		11	13		dB
Gain Flatness		±0.25			±0.5			±0.5		dB
Gain Variation Over Temperature		0.015	0.025		0.015	0.025		0.015	0.025	dB/°C
Noise Figure		3.5	4.5		2.5	3.5		4.0	5.0	dB
Input Return Loss		15			20			10		dB
Output Return Loss		13			15			8		dB
Output Power for 1 dB Compression (P1dB)	11	14		10	13		8.5	11.5		dBm
Saturated Output Power (P _{sat})		17			15.5			14		dBm
Output Third Order Intercept (IP3)		25			23			21		dBm
Supply Current		78			78			78		mA



WIDEBAND LNA MODULE, 2 - 20 GHz

Gain & Return Loss

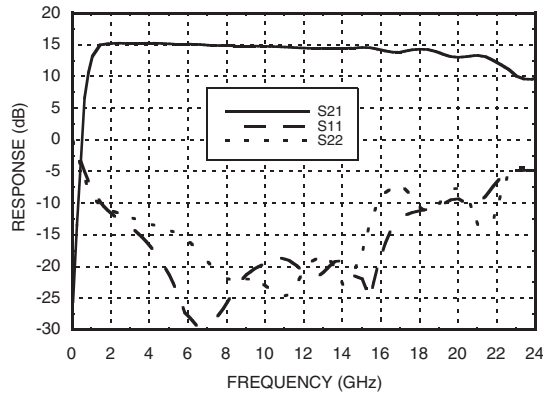

Gain vs. Temperature

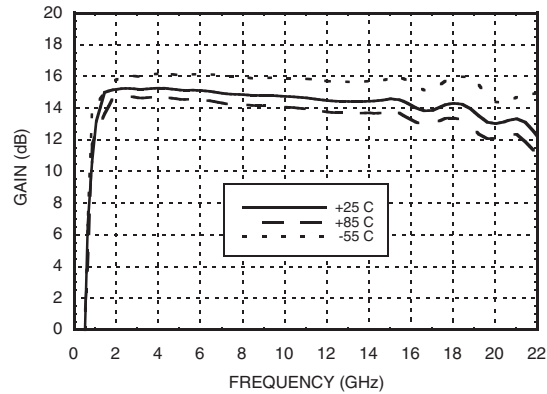

Input Return Loss vs. Temperature

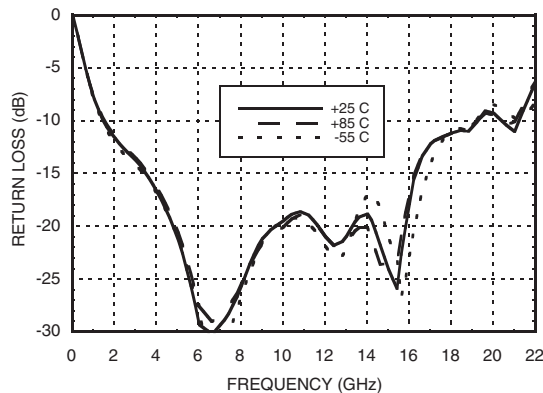

Output Return Loss vs. Temperature

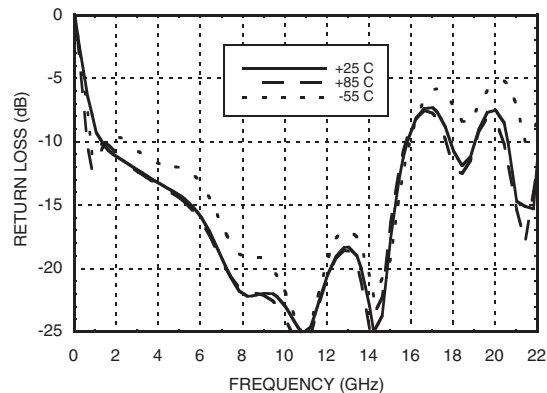

Reverse Isolation vs. Temperature

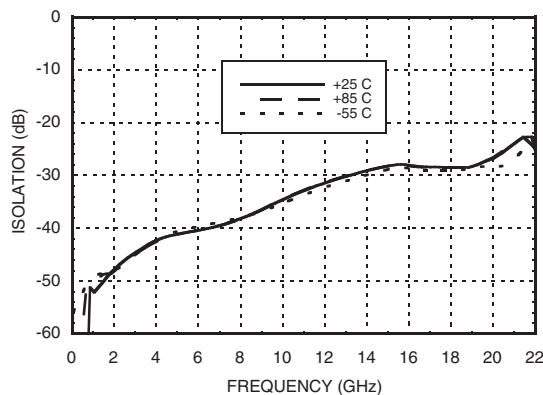

Noise Figure vs. Temperature

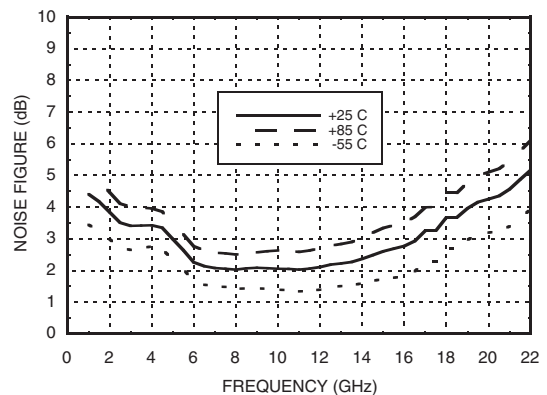

Information furnished by Analog Devices is believed to be accurate and reliable. However, no responsibility is assumed by Analog Devices for its use, nor for any infringements of patents or other rights of third parties that may result from its use. Specifications subject to change without notice. No license is granted by implication or otherwise under any patent or patent rights of Analog Devices. Trademarks and registered trademarks are the property of their respective owners.

For price, delivery, and to place orders: Analog Devices, Inc., One Technology Way, P.O. Box 9106, Norwood, MA 02062-9106 Phone: 781-329-4700 • Order online at www.analog.com Application Support: Phone: 1-800-ANALOG-D

WIDEBAND LNA MODULE, 2 - 20 GHz



P1dB vs. Temperature

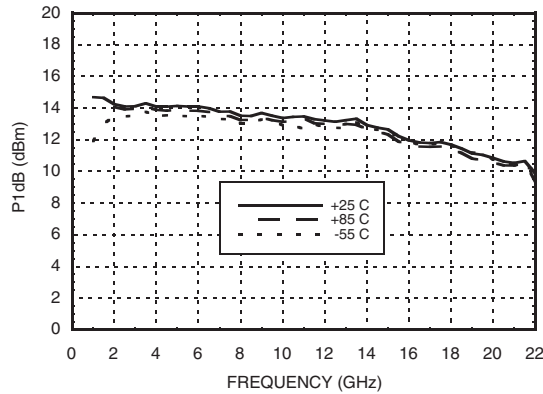

Psat vs. Temperature

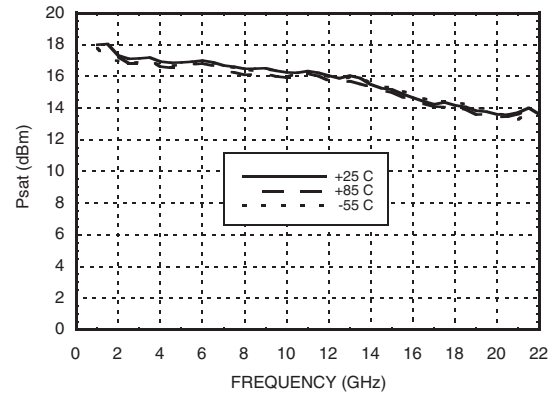

Output IP3 vs. Temperature

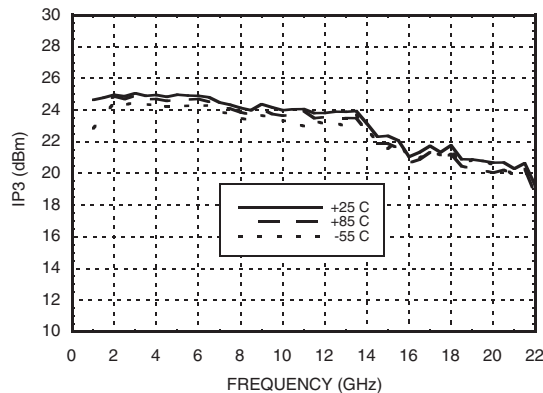

Absolute Maximum Ratings

Bias Supply Voltage (Vs)	-0.3 Vdc to +25 Vdc
RF Input Power (RFIN)	+23 dBm
Storage Temperature	-65 to +150 °C
Operating Temperature	-55 to +85 °C



**ELECTROSTATIC SENSITIVE DEVICE
OBSERVE HANDLING PRECAUTIONS**

Pin Descriptions

Pin Number	Function	Description	Interface Schematic
1	RFIN & RF Ground	RF input connector, SMA female, field replaceable. This pin is AC coupled and matched to 50 Ohms.	
2	Vs	Power supply voltage for the amplifier.	
3	RFOUT & RF Ground	RF output connector, SMA female, field replaceable. This pin is AC coupled and matched to 50 Ohms.	
4	GND	Power supply ground.	

Information furnished by Analog Devices is believed to be accurate and reliable. However, no responsibility is assumed by Analog Devices for its use, nor for any infringements of patents or other rights of third parties that may result from its use. Specifications subject to change without notice. No license is granted by implication or otherwise under any patent or patent rights of Analog Devices. Trademarks and registered trademarks are the property of their respective owners.

For price, delivery, and to place orders: Analog Devices, Inc., One Technology Way, P.O. Box 9106, Norwood, MA 02062-9106
Phone: 781-329-4700 • Order online at www.analog.com
Application Support: Phone: 1-800-ANALOG-D



Outline Drawing

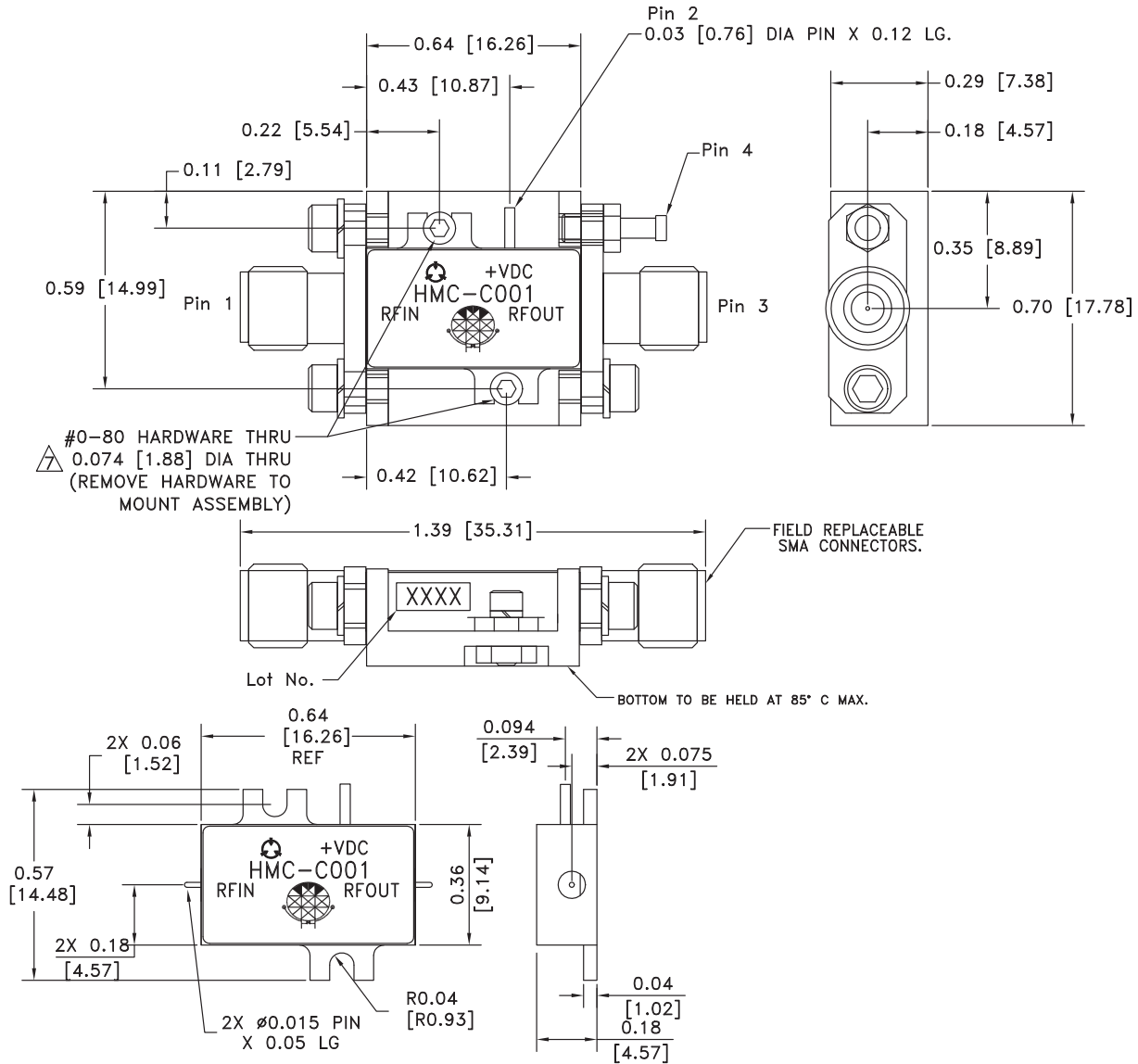

Package Information

Package Type	C-1
Package Weight [1]	10.2 gms [2]
Spacer Weight	N/A

[1] Includes the connectors

[2] ±1 gms Tolerance

NOTES:

1. PACKAGE, LEADS, COVER MATERIAL: KOVAR™
 2. BRACKET MATERIAL: ALUMINUM
 3. PLATING: ELECTROLYTIC GOLD 50 MICROINCHES MIN., OVER ELECTROLYTIC NICKEL 75 MICROINCHES MIN.
 4. ALL DIMENSIONS ARE IN INCHES [MILLIMETERS].
 5. TOLERANCES ±.005 [0.13] UNLESS OTHERWISE SPECIFIED.
 6. FIELD REPLACEABLE SMA CONNECTORS. TENSOLITE 5602 - 5CCSF OR EQUIVALENT.
- △ TO MOUNT MODULE TO SYSTEM PLATFORM REPLACE 0 - 80 HARDWARE WITH DESIRED MOUNTING SCREWS.

X-ON Electronics

Largest Supplier of Electrical and Electronic Components

Click to view similar products for [Sub-GHz Modules](#) category:

Click to view products by [Analog Devices](#) manufacturer:

Other Similar products are found below :

[HMC-C024](#) [nRF24L01P-MODULE-SMA](#) [CMD-KEY2-418-CRE](#) [V640-A90](#) [SM1231E868](#) [HMC-C582](#) [SM-MN-00-HF-RC](#) [HMC-C031](#)
[LoRa Node Kit\(US\)](#) [Sierra HL7588 4G KIT\(US\)](#) [WISE-4610-S672NA](#) [EC21AUFA-MINIPCIE](#) [EC21EUGA-MINIPCIE](#) [CS-EASYSWITCH-](#)
[25](#) [EC21JFB-MINIPCIE](#) [DL-RFM96-433M](#) [Ra-07H-V1.1](#) [Ra-07](#) [Ra-01SH](#) [Ra-01S-T](#) [Ra-01SH-T](#) [CMD-HHCP-418-MD](#) [CMD-HHCP-433-](#)
[MD](#) [CMD-HHLR-418-MD](#) [2095000000200](#) [XB9X-DMRS-031](#) [20911051101](#) [COM-13909](#) [HMC-C033](#) [COM-13910](#) [WRL-14498](#)
[SX1276RF1KAS](#) [HMC-C011](#) [HMC-C014](#) [HMC-C050](#) [HMC-C001](#) [HMC-C006](#) [HMC-C030](#) [HMC-C021](#) [HMC-C041](#) [HMC-C042](#) [HMC-](#)
[C048](#) [HMC-C051](#) [HMC-C071](#) [HMC-C072](#) [HMC-C088](#) [A2500R24C00GM](#) [702-W](#) [HUM-900-PRC](#) [ISP4520-EU-ST](#)