

FEATURES

- Low Voltage Noise: 4.5 nV/ Hz
- High Gain Bandwidth Product: 15 MHz
- High Slew Rate: 7.0 V/ μ s
- Low Input Offset Voltage: 0.3 mV
- Low T.C. of Input Offset Voltage: 2.0 μ V/ $^{\circ}$ C
- Low Distortion: 0.002%
- Excellent Frequency Stability
- Dual Supply Operation

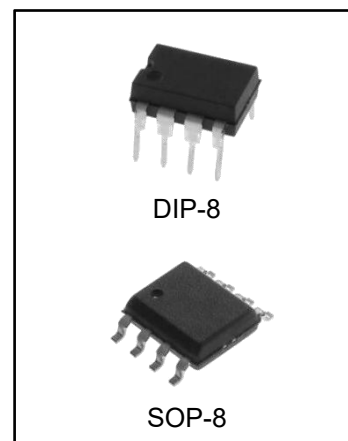

ORDERING INFORMATION

DEVICE	Package Type	MARKING	Packing	Packing Qty
LM833PG	DIP-8	LM833	TUBE	2000pcs/Box
LM833DRG	SOP-8	LM833	REEL	2500pcs/Reel

DESCRIPTION

The LM833 is a standard low-cost monolithic dual general-purpose operational amplifier employing Bipolar technology with innovative high-performance concepts for audio systems applications. With high frequency PNP transistors, the LM833 offers low voltage noise (4.5 nV/Hz), 15 MHz gain bandwidth product, $7.0 \text{ V}/\mu\text{s}$ slew rate, 0.3 mV input offset voltage with $2.0 \mu\text{V}/^\circ\text{C}$ temperature coefficient of input offset voltage. The LM833 output stage exhibits no deadband crossover distortion, large output voltage swing, excellent phase and gain margins, low open loop high frequency output impedance and symmetrical source/sink AC frequency response.

The LM833 is specified over the automotive temperature range and is available in the plastic DIP and SOP8 packages (M and N suffixes). For an improved performance dual/quad version, see the MC33079 family.

PIN CONNECTIONS

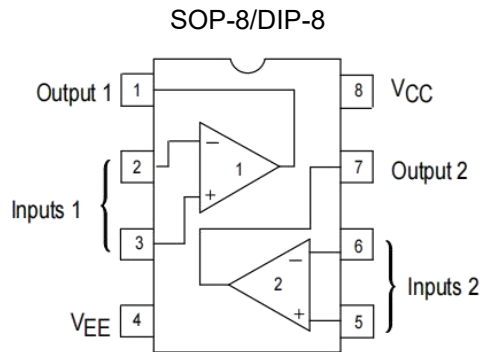

MAXIMUM RATINGS

Rating	Symbol	Value	Unit
Supply Voltage (V_{CC} to V_{EE})	V_S	+36	V
Input Differential Voltage Range (Note 1)	V_{IDR}	30	V
Input Voltage Range (Note 1)	V_{IR}	± 15	V
Output Short Circuit Duration (Note 2)	t_{SC}	Indefinite	
Operating Ambient Temperature Range	T_A	-40 to +85	$^\circ\text{C}$
Operating Junction Temperature	T_J	+150	$^\circ\text{C}$
Storage Temperature	T_{stg}	-60 to +150	$^\circ\text{C}$
Maximum Power Dissipation (Notes 2 and 3)	P_D	500	mW
Lead Temperature (Soldering, 10 seconds)	T_L	245	$^\circ\text{C}$

NOTES:

- 1、 Absolute Maximum Ratings indicate limits beyond which damage to the device may occur. Operating Ratings indicate conditions for which the device is intended to be functional, but specific performance is not ensured.
- 2、 Either or both input voltages must not exceed the magnitude of V_{CC} or V_{EE} .
- 3、 Power dissipation must be considered to ensure maximum junction temperature(T_J) is not exceeded (see power dissipation performance characteristic).
- 4、 Maximum value at $T_A \leq 85^\circ\text{C}$.

ELECTRICAL CHARACTERISTICS ($V_{CC} = +15\text{ V}$, $V_{EE} = -15\text{ V}$, $T_A = 25^\circ\text{C}$, unless otherwise noted.)

Characteristic	Symbol	Min	Typ	Max	Unit
Input Offset Voltage ($R_S = 10\Omega$, $V_O = 0\text{ V}$)	V_{IO}	–	0.3	5.0	mV
Average Temperature Coefficient of Input Offset Voltage $R_S = 10\Omega$, $V_O = 0\text{ V}$, $T_A = T_{low}$ to T_{high}	$\Delta V_{IO}/\Delta T$	–	2.0	–	$\mu\text{V}/^\circ\text{C}$
Input Offset Current ($V_{CM} = 0\text{ V}$, $V_O = 0\text{ V}$)	I_{IO}	–	10	200	nA
Input Bias Current ($V_{CM} = 0\text{ V}$, $V_O = 0\text{ V}$)	I_{IB}	–	300	1000	nA
Common Mode Input Voltage Range	V_{ICR}	– –12	+14 –14	+12 –	V
Large Signal Voltage Gain ($R_L = 2.0\text{ k}\Omega$, $V_O = \pm 10\text{ V}$)	A_{VOL}	90	110	–	dB
Output Voltage Swing: $R_L = 2.0\text{ k}\Omega$, $V_{ID} = 1.0\text{ V}$, $R_L = 2.0\text{ k}\Omega$, $V_{ID} = 1.0\text{ V}$ $R_L = 10\text{ k}\Omega$, $V_{ID} = 1.0\text{ V}$, $R_L = 10\text{ k}\Omega$, $V_{ID} = 1.0\text{ V}$	V_{O+} V_{O-} V_{O+} V_{O-}	10 – 12 –	13.7 –14.1 13.9 –14.7	– –10 – –12	V
Common Mode Rejection ($V_{in} = \pm 12\text{ V}$)	CMR	80	100	–	dB
Power Supply Rejection ($V_S = 15\text{ V}$ to 5.0 V , -15 V to -5.0 V)	PSR	80	115	–	dB
Power Supply Current ($V_O = 0\text{ V}$, Both Amplifiers)	I_D	–	4.0	8.0	mA

AC ELECTRICAL CHARACTERISTICS ($V_{CC} = +15\text{ V}$, $V_{EE} = -15\text{ V}$, $T_A = 25^\circ\text{C}$, unless otherwise noted.)

Characteristic	Symbol	Min	Typ	Max	Unit
Slew Rate ($V_{in} = -10\text{ V}$ to $+10\text{ V}$, $R_L = 2.0\text{ k}\Omega$, $A_V = +1.0$)	SR	5.0	7.0	–	$\text{V}/\mu\text{s}$
Gain Bandwidth Product ($f = 100\text{ kHz}$)	GBW	10	15	–	MHz
Unity Gain Frequency (Open Loop)	f_U	–	9.0	–	MHz
Unity Gain Phase Margin (Open Loop)	θ_m	–	60	–	Deg
Equivalent Input Noise Voltage ($R_S = 100\Omega$, $f = 1.0\text{ kHz}$)	e_n	–	4.5	–	$\text{nV}/\sqrt{\text{Hz}}$
Equivalent Input Noise Current ($f = 1.0\text{ kHz}$)	i_n	–	0.5	–	$\text{pA}/\sqrt{\text{Hz}}$
Power Bandwidth ($V_O = 27\text{ V}_{pp}$, $R_L = 2.0\text{ k}\Omega$, THD $\leq 1.0\%$)	BWP	–	120	–	kHz
Distortion ($R_L = 2.0\text{ k}\Omega$, $f = 20\text{ Hz}$ to 20 kHz , $V_O = 3.0\text{ V}_{rms}$, $A_V = +1.0$)	THD	–	0.002	–	%
Channel Separation ($f = 20\text{ Hz}$ to 20 kHz)	CS	–	–120	–	dB

Figure 1. Maximum Power Dissipation versus Temperature

Figure 2. Input Bias Current versus Temperature

Figure 3. Input Bias Current versus Supply Voltage

Figure 4. Supply Current versus Supply Voltage

Figure 5. DC Voltage Gain versus Temperature

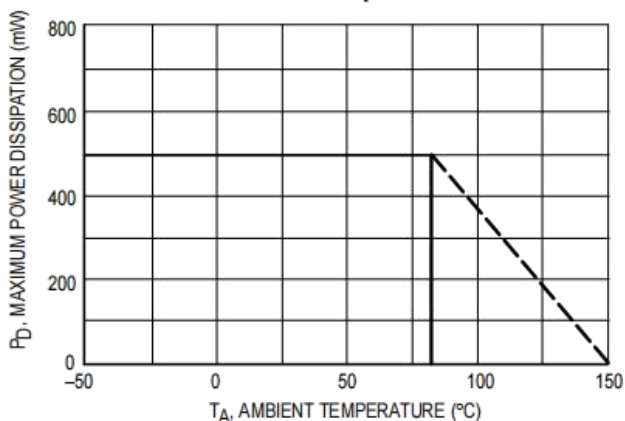
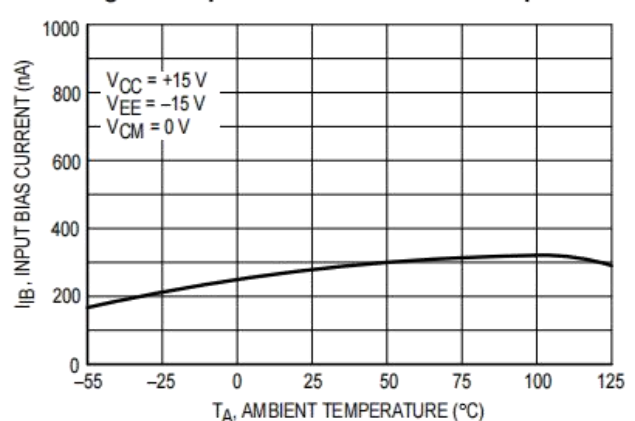
Figure 6. DC Voltage Gain versus Supply Voltage

Figure 7. Open Loop Voltage Gain and Phase versus Frequency

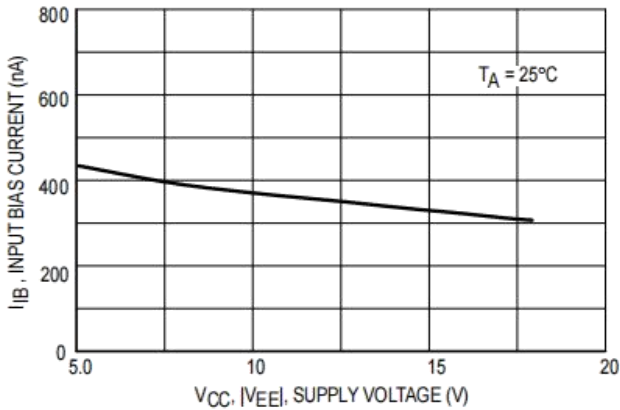
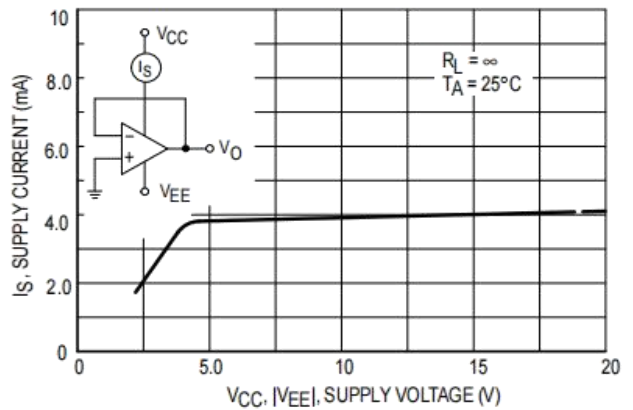
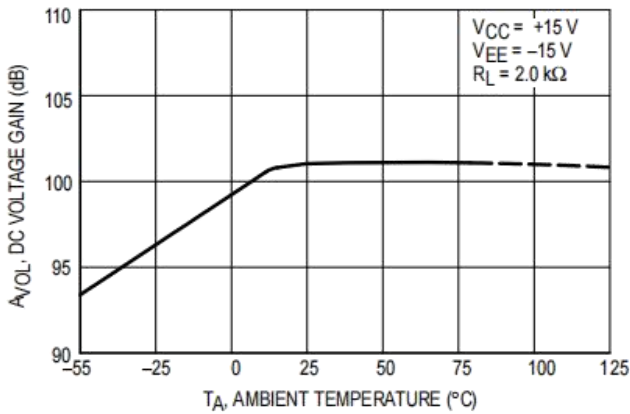
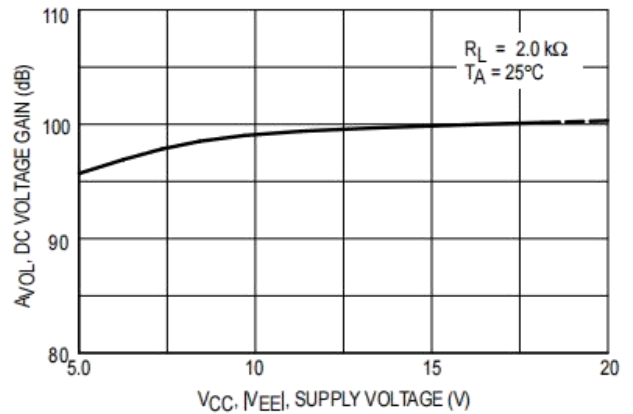
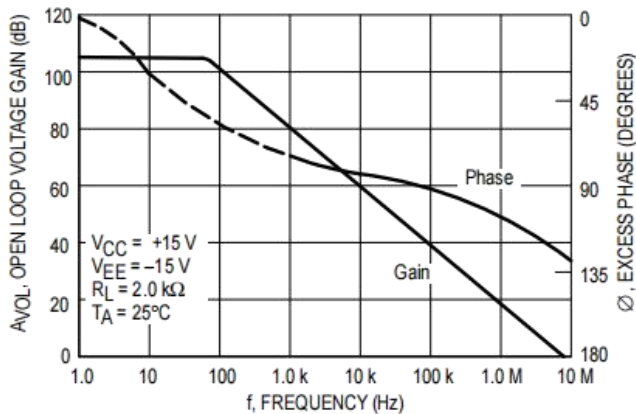
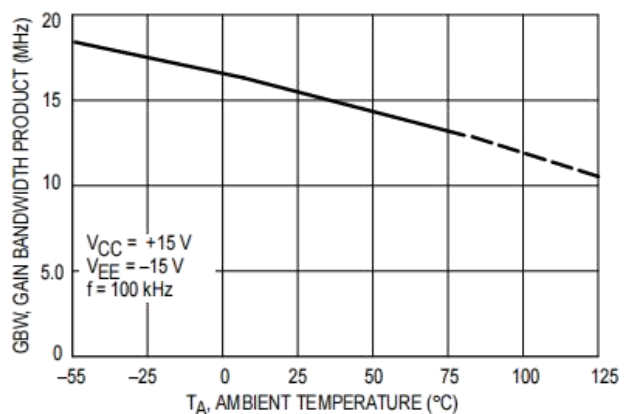
Figure 8. Gain Bandwidth Product versus Temperature

Figure 9. Gain Bandwidth Product versus Supply Voltage

Figure 10. Slew Rate versus Temperature

Figure 11. Slew Rate versus Supply Voltage

Figure 12. Output Voltage versus Frequency

Figure 13. Maximum Output Voltage versus Supply Voltage

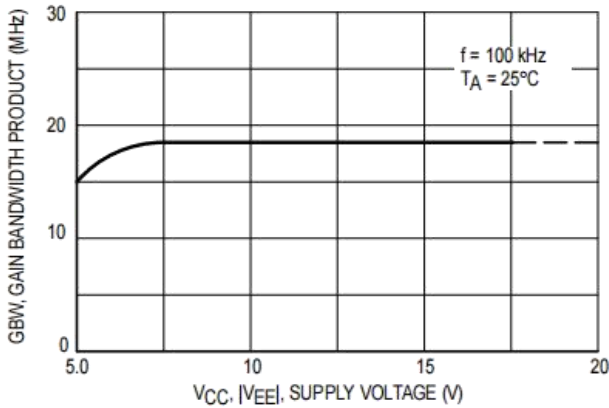
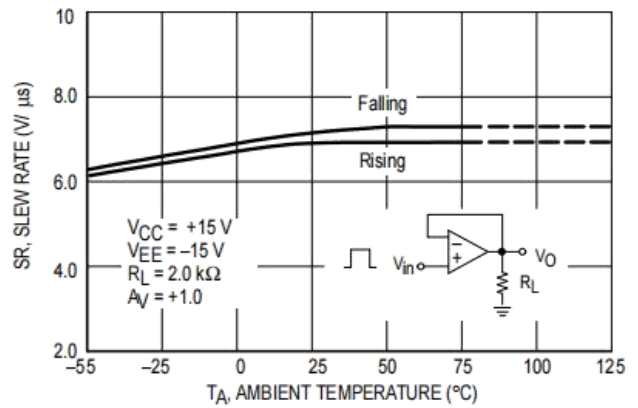
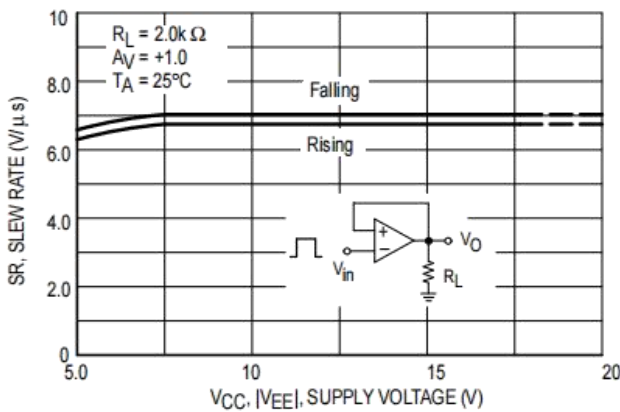
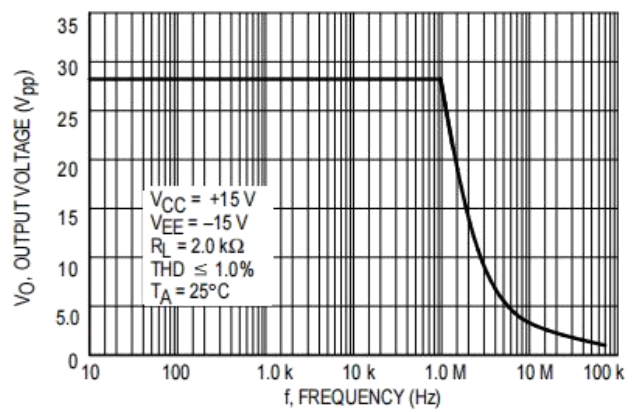
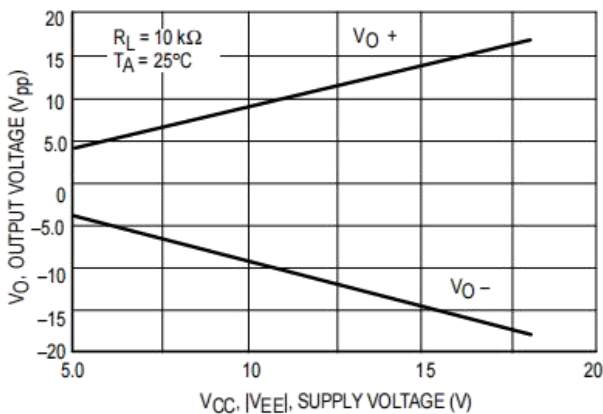
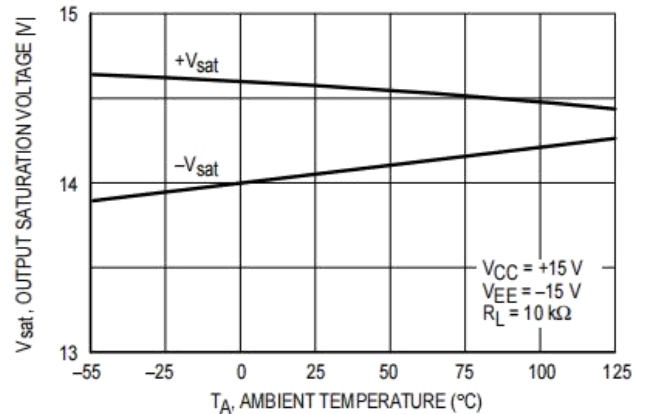
Figure 14. Output Saturation Voltage versus Temperature

Figure 15. Power Supply Rejection versus Frequency

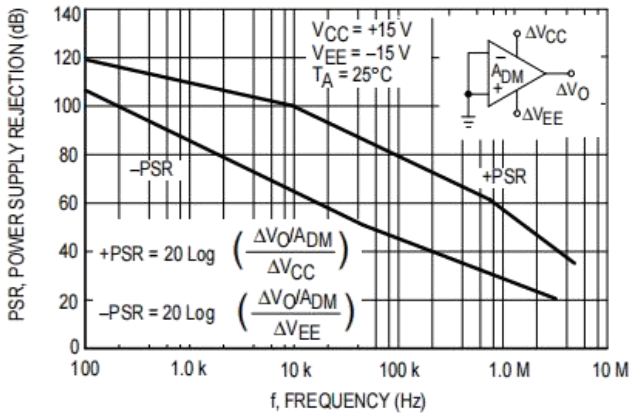

Figure 16. Common Mode Rejection versus Frequency

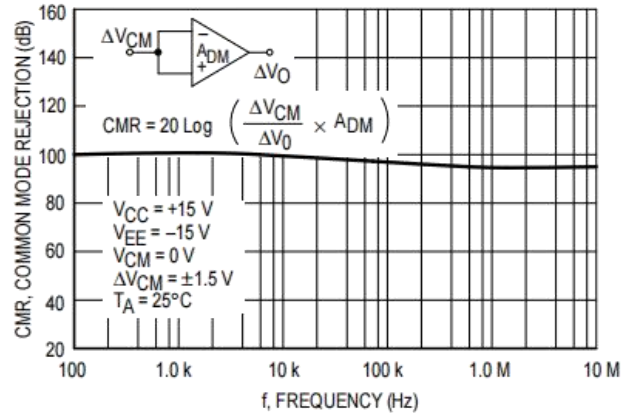

Figure 17. Total Harmonic Distortion versus Frequency

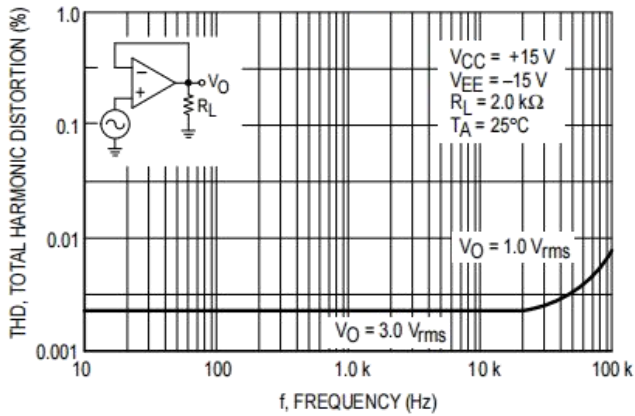

Figure 18. Input Referred Noise Voltage versus Frequency

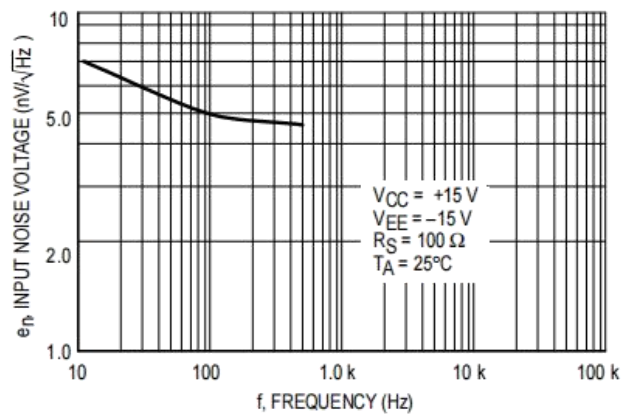

Figure 19. Input Referred Noise Current versus Frequency

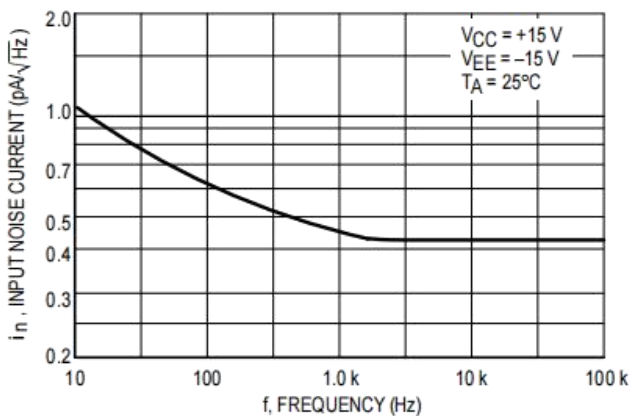

Figure 20. Input Referred Noise Voltage versus Source Resistance

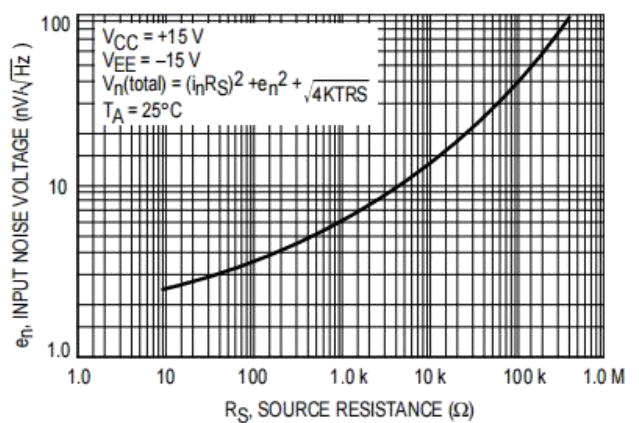
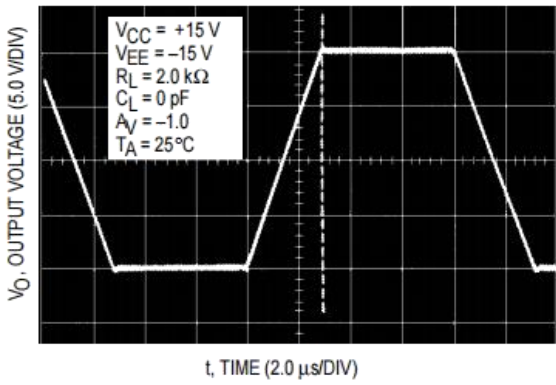
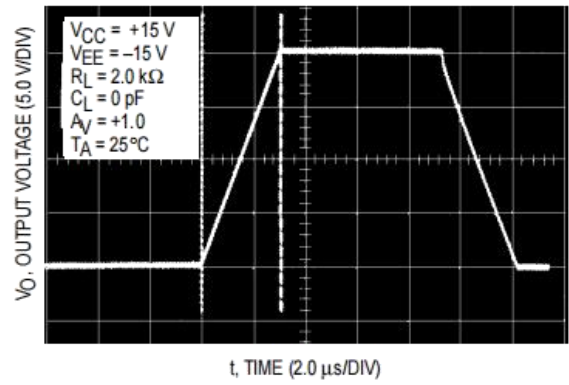
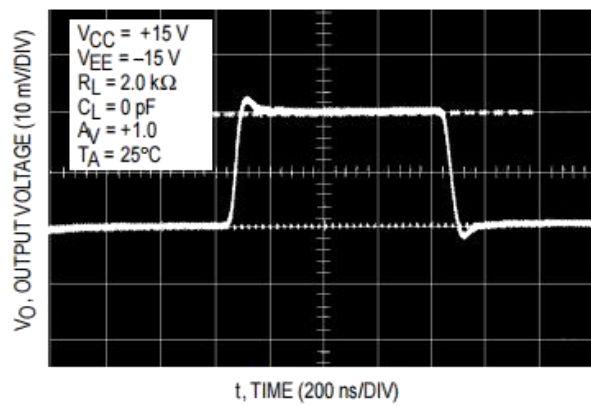
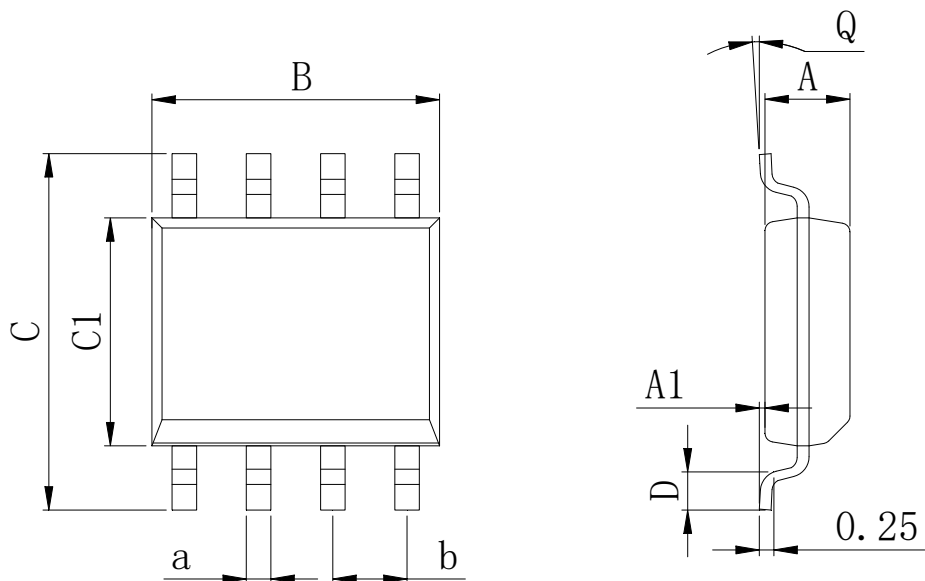
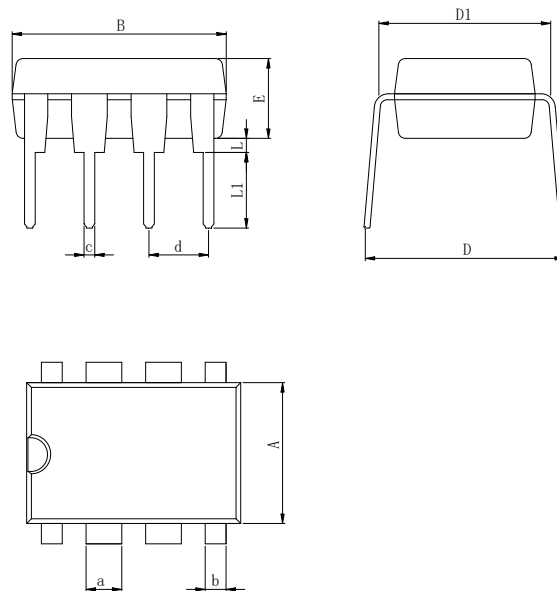

Figure 21. Inverting Amplifier

Figure 22. Noninverting Amplifier Slew Rate

Figure 23. Noninverting Amplifier Overshoot

PHYSICAL DIMENSIONS
SOP-8

Dimensions In Millimeters(SOP-8)

Symbol:	A	A1	B	C	C1	D	Q	a	b
Min:	1.35	0.05	4.90	5.80	3.80	0.40	0°	0.35	1.27 BSC
Max:	1.55	0.20	5.10	6.20	4.00	0.80	8°	0.45	

DIP-8

Dimensions In Millimeters(DIP-8)

Symbol:	A	B	D	D1	E	L	L1	a	b	c	d
Min:	6.10	9.00	8.10	7.42	3.10	0.50	3.00	1.50	0.85	0.40	2.54 BSC
Max:	6.68	9.50	10.9	7.82	3.55	0.70	3.60	1.55	0.90	0.50	

REVISION HISTORY

DATE	REVISION	PAGE
2018-6-8	New	1-10
2023-9-13	Update encapsulation type、Update Lead Temperature、Updated DIP-8 dimension、 Add annotation for Maximum Ratings.	1、 2、 8

IMPORTANT STATEMENT:

Hanschip Semiconductor reserves the right to change its products and services without notice. Before ordering, the customer shall obtain the latest relevant information and verify whether the information is up to date and complete. Hanschip Semiconductor does not assume any responsibility or obligation for the altered documents.

Customers are responsible for complying with safety standards and taking safety measures when using Hanschip Semiconductor products for system design and machine manufacturing. You will bear all the following responsibilities: select the appropriate Hanschip Semiconductor products for your application; Design, validate and test your application; Ensure that your application meets the appropriate standards and any other safety, security or other requirements. To avoid the occurrence of potential risks that may lead to personal injury or property loss.

Hanschip Semiconductor products have not been approved for applications in life support, military, aerospace and other fields, and Hanschip Semiconductor will not bear the consequences caused by the application of products in these fields. All problems, responsibilities and losses arising from the user's use beyond the applicable area of the product shall be borne by the user and have nothing to do with Hanschip Semiconductor, and the user shall not claim any compensation liability against Hanschip Semiconductor by the terms of this Agreement.

The technical and reliability data (including data sheets), design resources (including reference designs), application or other design suggestions, network tools, safety information and other resources provided for the performance of semiconductor products produced by Hanschip Semiconductor are not guaranteed to be free from defects and no warranty, express or implied, is made. The use of testing and other quality control technologies is limited to the quality assurance scope of Hanschip Semiconductor. Not all parameters of each device need to be tested.

The documentation of Hanschip Semiconductor authorizes you to use these resources only for developing the application of the product described in this document. You have no right to use any other Hanschip Semiconductor intellectual property rights or any third party intellectual property rights. It is strictly forbidden to make other copies or displays of these resources. You should fully compensate Hanschip Semiconductor and its agents for any claims, damages, costs, losses and debts caused by the use of these resources. Hanschip Semiconductor accepts no liability for any loss or damage caused by infringement.

X-ON Electronics

Largest Supplier of Electrical and Electronic Components

Click to view similar products for [Operational Amplifiers - Op Amps](#) category:

Click to view products by [Analog Devices](#) manufacturer:

Other Similar products are found below :

[430227FB](#) [LT1678IS8](#) [NCV33202DMR2G](#) [NJM324E](#) [M38510/13101BPA](#) [NTE925](#) [AZV358MTR-G1](#) [AP4310AUMTR-AG1](#)
[AZV358MMTR-G1](#) [SCY33178DR2G](#) [NCV20034DR2G](#) [NTE778S](#) [NTE871](#) [NTE937](#) [NJU7057RB1-TE2](#) [SCY6358ADR2G](#)
[NJM2904CRB1-TE1](#) [UPC4570G2-E1-A](#) [UPC4741G2-E1-A](#) [UPC4574GR-9LG-E1-A](#) [NJM8532RB1-TE1](#) [EL2250CS](#) [EL5100IS](#) [EL5104IS](#)
[EL5127CY](#) [EL5127CYZ](#) [EL5133IW](#) [EL5152IS](#) [EL5156IS](#) [EL5162IS](#) [EL5202IY](#) [EL5203IY](#) [EL5204IY](#) [EL5210CS](#) [EL5210CYZ](#)
[EL5211IYE](#) [EL5220CY](#) [EL5223CLZ](#) [EL5223CR](#) [EL5224ILZ](#) [EL5227CLZ](#) [EL5227CRZ](#) [EL5244CS](#) [EL5246CS](#) [EL5246CSZ](#) [EL5250IY](#)
[EL5251IS](#) [EL5257IS](#) [EL5260IY](#) [EL5261IS](#)