

# Low Cost Dual and Triple 300MHz Current Feedback Amplifiers with Shutdown

## FEATURES

- 300MHz Bandwidth on  $\pm 5V$  ( $A_V = 1, 2$  and  $-1$ )
- 0.1dB Gain Flatness: 150MHz ( $A_V = 1, 2$  and  $-1$ )
- Completely Off in Shutdown, 0 $\mu$ A Supply Current
- High Slew Rate: 800V/ $\mu$ s
- Wide Supply Range:
  - $\pm 2V(4V)$  to  $\pm 6V(12V)$  (LT1398/LT1399)
  - $\pm 2V(4V)$  to  $\pm 7.5V(15V)$  (LT1399HV)
- 80mA Output Current
- Low Supply Current: 4.6mA/Amplifier
- Fast Turn-On Time: 30ns
- Fast Turn-Off Time: 40ns
- 16-Pin Narrow SO/Narrow SSOP Packages

## APPLICATIONS

- RGB Cable Drivers
- LCD Drivers
- Spread Spectrum Amplifiers
- MUX Amplifiers
- Composite Video Cable Drivers
- Portable Equipment

## DESCRIPTION

The LT<sup>®</sup>1399 and LT1399HV contain three independent 300MHz current feedback amplifiers, each with a shutdown pin. The LT1399HV is a higher voltage version of the LT1399. The LT1398 is a two amplifier version of the LT1399.

The LT1398/LT1399 operate on all supplies from a single 4V to  $\pm 6V$ . The LT1399HV operates on all supplies from 4V to  $\pm 7.5V$ .

Each amplifier draws 4.6mA when active. When disabled each amplifier draws zero supply current and its output becomes high impedance. The amplifiers turn on in only 30ns and turn off in 40ns, making them ideal in spread spectrum and portable equipment applications.

The LT1398/LT1399/LT1399HV are manufactured on Linear Technology's proprietary complementary bipolar process. The LT1399/LT1399HV are pin-for-pin upgrades to the LT1260 optimized for use on  $\pm 5V/\pm 7.5V$  supplies.

 LTC and LT are registered trademarks of Linear Technology Corporation.

## TYPICAL APPLICATION

3-Input Video MUX Cable Driver



Square Wave Response

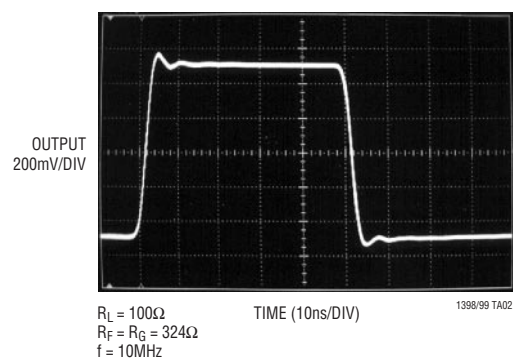

# LT1398/LT1399/LT1399HV

## ABSOLUTE MAXIMUM RATINGS (Note 1)

Total Supply Voltage ( $V^+$ to $V^-$ )		Output Short-Circuit Duration (Note 3) .....	Continuous
LT1398/LT1399 .....	12.6V	Operating Temperature Range (Note 9) ...	$-40^\circ\text{C}$ to $85^\circ\text{C}$
LT1399HV .....	15.5V	Specified Temperature Range (Note 4) ..	$-40^\circ\text{C}$ to $85^\circ\text{C}$
Input Current (Note 2) .....	$\pm 10\text{mA}$	Storage Temperature Range .....	$-65^\circ\text{C}$ to $150^\circ\text{C}$
Output Current .....	$\pm 100\text{mA}$	Junction Temperature (Note 5) .....	$150^\circ\text{C}$
Differential Input Voltage (Note 2) .....	$\pm 5\text{V}$	Lead Temperature (Soldering, 10 sec) .....	$300^\circ\text{C}$

## PACKAGE/ORDER INFORMATION

<p>S PACKAGE 16-LEAD PLASTIC SO <math>T_{JMAX} = 150^\circ\text{C}</math>, <math>\theta_{JA} = 100^\circ\text{C/W}</math></p>	ORDER PART NUMBER	<p>GN PACKAGE 16-LEAD PLASTIC SSOP S PACKAGE 16-LEAD PLASTIC SO <math>T_{JMAX} = 150^\circ\text{C}</math>, <math>\theta_{JA} = 120^\circ\text{C/W}</math> (GN) <math>T_{JMAX} = 150^\circ\text{C}</math>, <math>\theta_{JA} = 100^\circ\text{C/W}</math> (S)</p>	ORDER PART NUMBER
	LT1398CS		LT1399CGN LT1399CS LT1399HVCS LT1399IGN LT1399IS
		GN PART MARKING	
		1399 1399I	

\* Ground pins are not internally connected. For best channel isolation, connect to ground. Consult factory for parts specified with wider operating temperature ranges.

## ELECTRICAL CHARACTERISTICS (LT1398/LT1399)

The ● denotes specifications which apply over the specified operating temperature range, otherwise specifications are at  $T_A = 25^\circ\text{C}$ . For each amplifier:  $V_{CM} = 0\text{V}$ ,  $V_S = \pm 5\text{V}$ ,  $\overline{\text{EN}} = 0\text{V}$ , pulse tested, unless otherwise noted. (Note 4)

SYMBOL	PARAMETER	CONDITIONS	MIN	TYP	MAX	UNITS
$V_{OS}$	Input Offset Voltage		●	1.5	10	mV
				12	mV	
$\Delta V_{OS}/\Delta T$	Input Offset Voltage Drift		●	15		$\mu\text{V}/^\circ\text{C}$
$I_{IN}^+$	Noninverting Input Current		●	10	25	$\mu\text{A}$
				30	$\mu\text{A}$	
$I_{IN}^-$	Inverting Input Current		●	10	50	$\mu\text{A}$
				60	$\mu\text{A}$	
$e_n$	Input Noise Voltage Density	$f = 1\text{kHz}$ , $R_F = 1\text{k}$ , $R_G = 10\Omega$ , $R_S = 0\Omega$		4.5		$\text{nV}/\sqrt{\text{Hz}}$
$+i_n$	Noninverting Input Noise Current Density	$f = 1\text{kHz}$		6		$\text{pA}/\sqrt{\text{Hz}}$
$-i_n$	Inverting Input Noise Current Density	$f = 1\text{kHz}$		25		$\text{pA}/\sqrt{\text{Hz}}$
$R_{IN}$	Input Resistance	$V_{IN} = \pm 3.5\text{V}$	●	0.3	1	$\text{M}\Omega$
$C_{IN}$	Input Capacitance	Amplifier Enabled Amplifier Disabled		2.0		pF
				2.5		pF
$C_{OUT}$	Output Capacitance	Amplifier Disabled		8.5		pF
$V_{INH}$	Input Voltage Range, High	$V_S = \pm 5\text{V}$ $V_S = 5\text{V}, 0\text{V}$	●	3.5	4.0	V
				4.0	V	

sn13989 13989fas

**ELECTRICAL CHARACTERISTICS** (LT1398/LT1399)

The ● denotes specifications which apply over the specified operating temperature range, otherwise specifications are at  $T_A = 25^\circ\text{C}$ . For each amplifier:  $V_{CM} = 0\text{V}$ ,  $V_S = \pm 5\text{V}$ ,  $\overline{\text{EN}} = 0\text{V}$ , pulse tested, unless otherwise noted. (Note 4)

SYMBOL	PARAMETER	CONDITIONS		MIN	TYP	MAX	UNITS
$V_{INL}$	Input Voltage Range, Low	$V_S = \pm 5\text{V}$ $V_S = 5\text{V}, 0\text{V}$	●	-3.5	-4.0 1.0		V V
$V_{OUTH}$	Maximum Output Voltage Swing, High	$V_S = \pm 5\text{V}, R_L = 100\text{k}$ $V_S = \pm 5\text{V}, R_L = 100\text{k}$ $V_S = 5\text{V}, 0\text{V}; R_L = 100\text{k}$	●	3.9 3.7	4.2 4.2		V V V
$V_{OUTL}$	Maximum Output Voltage Swing, Low	$V_S = \pm 5\text{V}, R_L = 100\text{k}$ $V_S = \pm 5\text{V}, R_L = 100\text{k}$ $V_S = 5\text{V}, 0\text{V}; R_L = 100\text{k}$	●	-3.9 -3.7	-4.2 0.8		V V V
$V_{OUTH}$	Maximum Output Voltage Swing, High	$V_S = \pm 5\text{V}, R_L = 150\Omega$ $V_S = \pm 5\text{V}, R_L = 150\Omega$ $V_S = 5\text{V}, 0\text{V}; R_L = 150\Omega$	●	3.4 3.2	3.6 3.6		V V V
$V_{OUTL}$	Maximum Output Voltage Swing, Low	$V_S = \pm 5\text{V}, R_L = 150\Omega$ $V_S = \pm 5\text{V}, R_L = 150\Omega$ $V_S = 5\text{V}, 0\text{V}; R_L = 150\Omega$	●	-3.4 -3.2	-3.6 0.6		V V V
CMRR	Common Mode Rejection Ratio	$V_{CM} = \pm 3.5\text{V}$	●	42	52		dB
$-I_{CMRR}$	Inverting Input Current Common Mode Rejection	$V_{CM} = \pm 3.5\text{V}$ $V_{CM} = \pm 3.5\text{V}$	●		10	16 22	$\mu\text{A}/\text{V}$ $\mu\text{A}/\text{V}$
PSRR	Power Supply Rejection Ratio	$V_S = \pm 2\text{V}$ to $\pm 5\text{V}$ , $\overline{\text{EN}} = V^-$	●	56	70		dB
$+I_{PSRR}$	Noninverting Input Current Power Supply Rejection	$V_S = \pm 2\text{V}$ to $\pm 5\text{V}$ , $\overline{\text{EN}} = V^-$	●		1	2 3	$\mu\text{A}/\text{V}$ $\mu\text{A}/\text{V}$
$-I_{PSRR}$	Inverting Input Current Power Supply Rejection	$V_S = \pm 2\text{V}$ to $\pm 5\text{V}$ , $\overline{\text{EN}} = V^-$	●		2	7	$\mu\text{A}/\text{V}$
$A_V$	Large-Signal Voltage Gain	$V_{OUT} = \pm 2\text{V}, R_L = 150\Omega$		50	65		dB
$R_{OL}$	Transimpedance, $\Delta V_{OUT}/\Delta I_{IN}^-$	$V_{OUT} = \pm 2\text{V}, R_L = 150\Omega$		40	100		$\text{k}\Omega$
$I_{OUT}$	Maximum Output Current	$R_L = 0\Omega$	●	80			mA
$I_S$	Supply Current per Amplifier	$V_{OUT} = 0\text{V}$	●		4.6	6.5	mA
	Disable Supply Current per Amplifier	$\overline{\text{EN}}$ Pin Voltage = 4.5V, $R_L = 150\Omega$	●		0.1	100	$\mu\text{A}$
$I_{\overline{\text{EN}}}$	Enable Pin Current		●		30	110 200	$\mu\text{A}$ $\mu\text{A}$
SR	Slew Rate (Note 6)	$A_V = 10, R_L = 150\Omega$		500	800		V/ $\mu\text{s}$
$t_{ON}$	Turn-On Delay Time (Note 7)	$R_F = R_G = 324\Omega, R_L = 100\Omega$			30	75	ns
$t_{OFF}$	Turn-Off Delay Time (Note 7)	$R_F = R_G = 324\Omega, R_L = 100\Omega$			40	100	ns
$t_r, t_f$	Small-Signal Rise and Fall Time	$R_F = R_G = 324\Omega, R_L = 100\Omega, V_{OUT} = 1\text{V}_{P-P}$			1.3		ns
$t_{PD}$	Propagation Delay	$R_F = R_G = 324\Omega, R_L = 100\Omega, V_{OUT} = 1\text{V}_{P-P}$			2.5		ns
os	Small-Signal Overshoot	$R_F = R_G = 324\Omega, R_L = 100\Omega, V_{OUT} = 1\text{V}_{P-P}$			10		%
$t_S$	Settling Time	0.1%, $A_V = -1, R_F = R_G = 309\Omega, R_L = 150\Omega$			25		ns
dG	Differential Gain (Note 8)	$R_F = R_G = 324\Omega, R_L = 150\Omega$			0.13		%
dP	Differential Phase (Note 8)	$R_F = R_G = 324\Omega, R_L = 150\Omega$			0.10		DEG

## ELECTRICAL CHARACTERISTICS (LT1399HV)

The ● denotes specifications which apply over the specified operating temperature range, otherwise specifications are at  $T_A = 25^\circ\text{C}$ . For each amplifier:  $V_{CM} = 0\text{V}$ ,  $V_S = \pm 7.5\text{V}$ ,  $\overline{EN} = 0\text{V}$ , pulse tested, unless otherwise noted. (Note 4)

SYMBOL	PARAMETER	CONDITIONS	MIN	TYP	MAX	UNITS
$V_{OS}$	Input Offset Voltage		●	1.5	10	mV
					12	mV
$\Delta V_{OS}/\Delta T$	Input Offset Voltage Drift		●	15		$\mu\text{V}/^\circ\text{C}$
$I_{IN}^+$	Noninverting Input Current		●	10	25	$\mu\text{A}$
					30	$\mu\text{A}$
$I_{IN}^-$	Inverting Input Current		●	10	50	$\mu\text{A}$
					60	$\mu\text{A}$
$e_n$	Input Noise Voltage Density	$f = 1\text{kHz}$ , $R_F = 1\text{k}$ , $R_G = 10\Omega$ , $R_S = 0\Omega$ , $V_S = \pm 5\text{V}$		4.5		$\text{nV}/\sqrt{\text{Hz}}$
$+i_n$	Noninverting Input Noise Current Density	$f = 1\text{kHz}$ , $V_S = \pm 5\text{V}$		6		$\text{pA}/\sqrt{\text{Hz}}$
$-i_n$	Inverting Input Noise Current Density	$f = 1\text{kHz}$ , $V_S = \pm 5\text{V}$		25		$\text{pA}/\sqrt{\text{Hz}}$
$R_{IN}$	Input Resistance	$V_{IN} = \pm 6\text{V}$	●	0.3	1	$\text{M}\Omega$
$C_{IN}$	Input Capacitance	Amplifier Enabled Amplifier Disabled		2.0		pF
				2.5		pF
$C_{OUT}$	Output Capacitance	Amplifier Disabled		8.5		pF
$V_{INH}$	Input Voltage Range, High	$V_S = \pm 7.5\text{V}$ $V_S = 7.5\text{V}, 0\text{V}$	●	6	6.5	V
					6.5	V
$V_{INL}$	Input Voltage Range, Low	$V_S = \pm 7.5\text{V}$ $V_S = 7.5\text{V}, 0\text{V}$	●	-6	-6.5	V
					1.0	V
$V_{OUTH}$	Maximum Output Voltage Swing, High	$V_S = \pm 7.5\text{V}$ , $R_L = 100\text{k}$ $V_S = \pm 7.5\text{V}$ , $R_L = 100\text{k}$ $V_S = 7.5\text{V}, 0\text{V}$ ; $R_L = 100\text{k}$	●	6.4	6.7	V
					6.1	V
					6.7	V
$V_{OUTL}$	Maximum Output Voltage Swing, Low	$V_S = \pm 7.5\text{V}$ , $R_L = 100\text{k}$ $V_S = \pm 7.5\text{V}$ , $R_L = 100\text{k}$ $V_S = 7.5\text{V}, 0\text{V}$ ; $R_L = 100\text{k}$	●	-6.4	-6.7	V
					-6.1	V
					0.8	V
$V_{OUTH}$	Maximum Output Voltage Swing, High	$V_S = \pm 7.5\text{V}$ , $R_L = 150\Omega$ $V_S = \pm 7.5\text{V}$ , $R_L = 150\Omega$ $V_S = 7.5\text{V}, 0\text{V}$ ; $R_L = 150\Omega$	●	5.4	5.8	V
					5.1	V
					5.8	V
$V_{OUTL}$	Maximum Output Voltage Swing, Low	$V_S = \pm 7.5\text{V}$ , $R_L = 150\Omega$ $V_S = \pm 7.5\text{V}$ , $R_L = 150\Omega$ $V_S = 7.5\text{V}, 0\text{V}$ ; $R_L = 150\Omega$	●	-5.4	-5.8	V
					-5.1	V
					0.6	V
$\text{CMRR}$	Common Mode Rejection Ratio	$V_{CM} = \pm 6\text{V}$	●	42	52	dB
$-I_{\text{CMRR}}$	Inverting Input Current Common Mode Rejection	$V_{CM} = \pm 6\text{V}$ $V_{CM} = \pm 6\text{V}$	●	10	16	$\mu\text{A}/\text{V}$
					22	$\mu\text{A}/\text{V}$
$\text{PSRR}$	Power Supply Rejection Ratio	$V_S = \pm 2\text{V}$ to $\pm 7.5\text{V}$ , $\overline{EN} = V^-$	●	56	70	dB
$+I_{\text{PSRR}}$	Noninverting Input Current Power Supply Rejection	$V_S = \pm 2\text{V}$ to $\pm 7.5\text{V}$ , $\overline{EN} = V^-$	●	1	2	$\mu\text{A}/\text{V}$
					3	$\mu\text{A}/\text{V}$
$-I_{\text{PSRR}}$	Inverting Input Current Power Supply Rejection	$V_S = \pm 2\text{V}$ to $\pm 7.5\text{V}$ , $\overline{EN} = V^-$	●	2	7	$\mu\text{A}/\text{V}$
$A_V$	Large-Signal Voltage Gain	$V_{OUT} = \pm 4.5\text{V}$ , $R_L = 150\Omega$		50	65	dB
$R_{OL}$	Transimpedance, $\Delta V_{OUT}/\Delta I_{IN}^-$	$V_{OUT} = \pm 4.5\text{V}$ , $R_L = 150\Omega$		40	100	$\text{k}\Omega$
$I_{OUT}$	Maximum Output Current	$R_L = 0\Omega$	●	80		mA
$I_S$	Supply Current per Amplifier	$V_{OUT} = 0\text{V}$	●	4.6	7	mA
	Disable Supply Current per Amplifier	$\overline{EN}$ Pin Voltage = $7\text{V}$ , $R_L = 150\Omega$	●	0.1	100	$\mu\text{A}$
$I_{EN}$	Enable Pin Current		●	30	110	$\mu\text{A}$
					200	$\mu\text{A}$

## ELECTRICAL CHARACTERISTICS (LT1399HV)

The ● denotes specifications which apply over the specified operating temperature range, otherwise specifications are at  $T_A = 25^\circ\text{C}$ . For each amplifier:  $V_{CM} = 0\text{V}$ ,  $V_S = \pm 7.5\text{V}$ ,  $\overline{EN} = 0\text{V}$ , pulse tested, unless otherwise noted. (Note 4)

SYMBOL	PARAMETER	CONDITIONS	MIN	TYP	MAX	UNITS
SR	Slew Rate (Note 6)	$A_V = 10$ , $R_L = 150\Omega$ , $V_S = \pm 5\text{V}$	500	800		V/ $\mu\text{s}$
$t_{ON}$	Turn-On Delay Time (Note 7)	$R_F = R_G = 324\Omega$ , $R_L = 100\Omega$ , $V_S = \pm 5\text{V}$		30	75	ns
$t_{OFF}$	Turn-Off Delay Time (Note 7)	$R_F = R_G = 324\Omega$ , $R_L = 100\Omega$ , $V_S = \pm 5\text{V}$		40	100	ns
$t_r$ , $t_f$	Small-Signal Rise and Fall Time	$R_F = R_G = 324\Omega$ , $R_L = 100\Omega$ , $V_{OUT} = 1\text{V}_{P-P}$ , $V_S = \pm 5\text{V}$		1.3		ns
$t_{PD}$	Propagation Delay	$R_F = R_G = 324\Omega$ , $R_L = 100\Omega$ , $V_{OUT} = 1\text{V}_{P-P}$ , $V_S = \pm 5\text{V}$		2.5		ns
os	Small-Signal Overshoot	$R_F = R_G = 324\Omega$ , $R_L = 100\Omega$ , $V_{OUT} = 1\text{V}_{P-P}$ , $V_S = \pm 5\text{V}$		10		%
$t_S$	Settling Time	0.1%, $A_V = -1\text{V}$ , $R_F = R_G = 309\Omega$ , $R_L = 150\Omega$ , $V_S = \pm 5\text{V}$		25		ns
dG	Differential Gain (Note 8)	$R_F = R_G = 324\Omega$ , $R_L = 150\Omega$ , $V_S = \pm 5\text{V}$		0.13		%
dP	Differential Phase (Note 8)	$R_F = R_G = 324\Omega$ , $R_L = 150\Omega$ , $V_S = \pm 5\text{V}$		0.10		DEG

**Note 1:** Absolute Maximum Ratings are those values beyond which the life of a device may be impaired.

**Note 2:** This parameter is guaranteed to meet specified performance through design and characterization. It has not been tested.

**Note 3:** A heat sink may be required depending on the power supply voltage and how many amplifiers have their outputs short circuited.

**Note 4:** The LT1398C/LT1399C/LT1399HVC are guaranteed to meet specified performance from  $0^\circ\text{C}$  to  $70^\circ\text{C}$  and are designed, characterized and expected to meet these extended temperature limits, but are not tested or QA sampled at  $-40^\circ\text{C}$  and  $85^\circ\text{C}$ . The LT1399I is guaranteed to meet specified performance from  $-40^\circ\text{C}$  to  $85^\circ\text{C}$ .

**Note 5:**  $T_J$  is calculated from the ambient temperature  $T_A$  and the power dissipation  $P_D$  according to the following formula:

LT1398CS, LT1399CS, LT1399IS, LT1399HVCS:

$$T_J = T_A + (P_D \cdot 100^\circ\text{C/W})$$

$$\text{LT1399CGN, LT1399IGN: } T_J = T_A + (P_D \cdot 120^\circ\text{C/W})$$

**Note 6:** Slew rate is measured at  $\pm 2\text{V}$  on a  $\pm 3\text{V}$  output signal.

**Note 7:** Turn-on delay time ( $t_{ON}$ ) is measured from control input to appearance of  $1\text{V}$  at the output, for  $V_{IN} = 1\text{V}$ . Likewise, turn-off delay time ( $t_{OFF}$ ) is measured from control input to appearance of  $0.5\text{V}$  on the output for  $V_{IN} = 0.5\text{V}$ . This specification is guaranteed by design and characterization.

**Note 8:** Differential gain and phase are measured using a Tektronix TSG120YC/NTSC signal generator and a Tektronix 1780R Video Measurement Set. The resolution of this equipment is  $0.1\%$  and  $0.1^\circ$ . Ten identical amplifier stages were cascaded giving an effective resolution of  $0.01\%$  and  $0.01^\circ$ .

**Note 9:** The LT1398C, LT1398I, LT1399C, LT1399I, LT1399HVC and LT1399HVI are guaranteed functional over the operating temperature range of  $-40^\circ\text{C}$  to  $85^\circ\text{C}$ .

## TYPICAL AC PERFORMANCE

$V_S$ (V)	$A_V$	$R_L$ ( $\Omega$ )	$R_F$ ( $\Omega$ )	$R_G$ ( $\Omega$ )	SMALL SIGNAL -3dB BW (MHz)	SMALL SIGNAL 0.1dB BW (MHz)	SMALL SIGNAL PEAKING (dB)
$\pm 5$	1	100	365	—	300	150	0.05
$\pm 5$	2	100	324	324	300	150	0
$\pm 5$	-1	100	309	309	300	150	0

# TYPICAL PERFORMANCE CHARACTERISTICS

**Closed-Loop Gain vs Frequency ( $A_V = 1$ )**



**Closed-Loop Gain vs Frequency ( $A_V = 2$ )**



**Closed-Loop Gain vs Frequency ( $A_V = -1$ )**



**Large-Signal Transient Response ( $A_V = 1$ )**



**Large-Signal Transient Response ( $A_V = 2$ )**

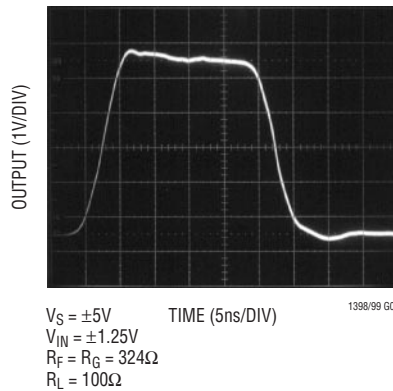

**Large-Signal Transient Response ( $A_V = -1$ )**

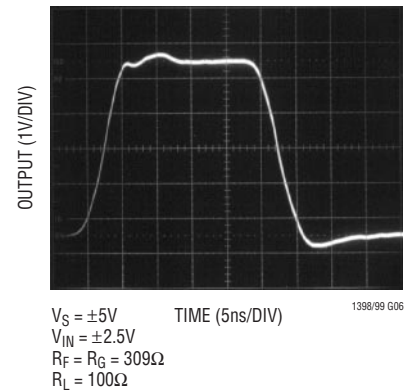

**2nd and 3rd Harmonic Distortion vs Frequency**



**Maximum Undistorted Output Voltage vs Frequency**



**PSRR vs Frequency**

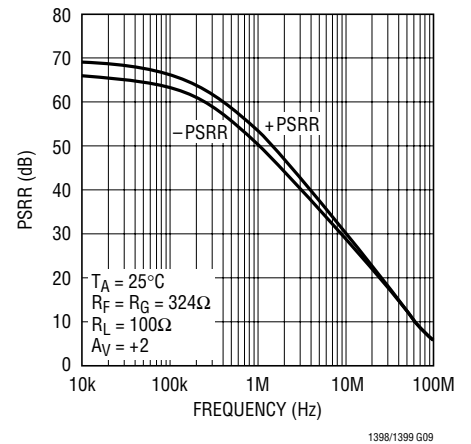

# TYPICAL PERFORMANCE CHARACTERISTICS

**Input Voltage Noise and Current Noise vs Frequency**



1398/1399 G10

**Output Impedance vs Frequency**

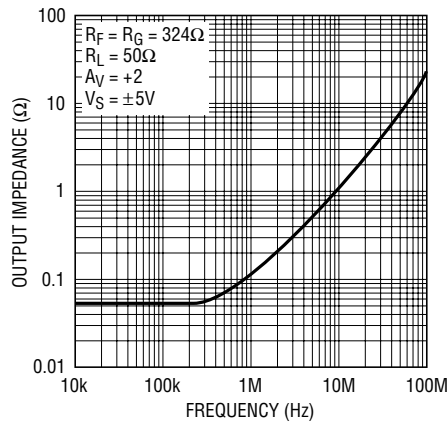

1398/1399 G11

**Output Impedance (Disabled) vs Frequency**



1398/1399 G12

**Maximum Capacitive Load vs Feedback Resistor**

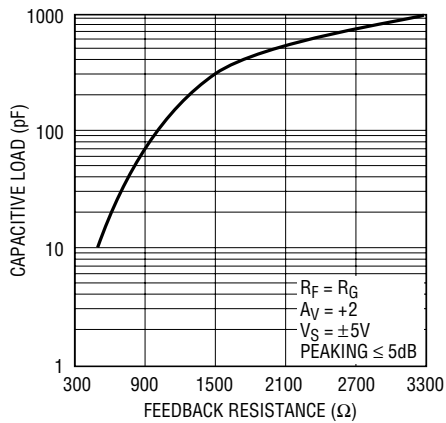

1398/1399 G13

**Capacitive Load vs Output Series Resistor**

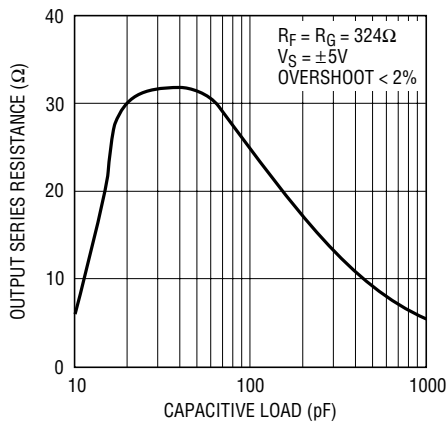

1398/1399 G14

**Supply Current vs Supply Voltage**

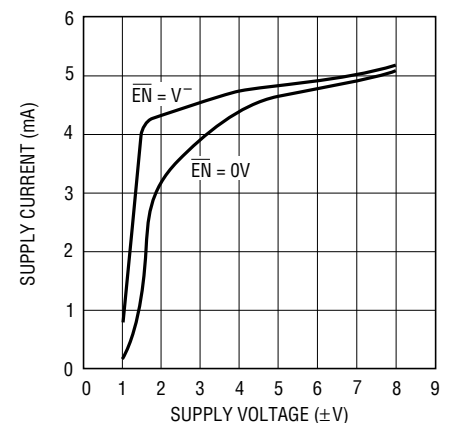

1398/1399 G15

**Output Voltage Swing vs Temperature**

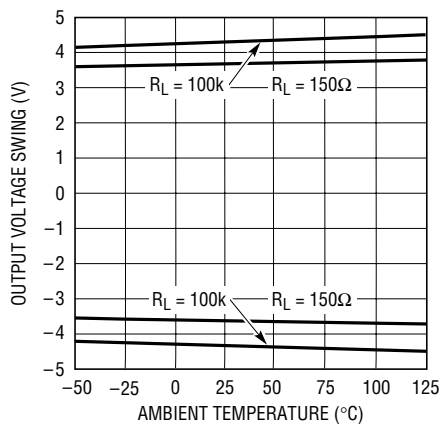

1398/1399 G16

**Enable Pin Current vs Temperature**

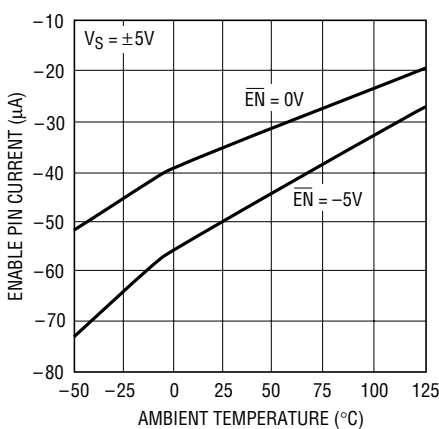

1398/1399 G17

**Positive Supply Current per Amplifier vs Temperature**

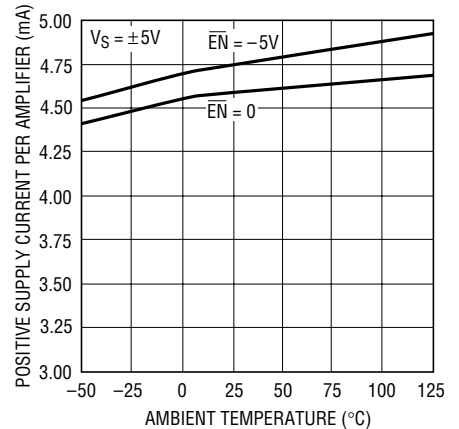

1398/1399 G18



# TYPICAL PERFORMANCE CHARACTERISTICS

**Input Offset Voltage vs Temperature**



1398/1399 G19

**Input Bias Currents vs Temperature**



1398/99 G20

**All Hostile Crosstalk**

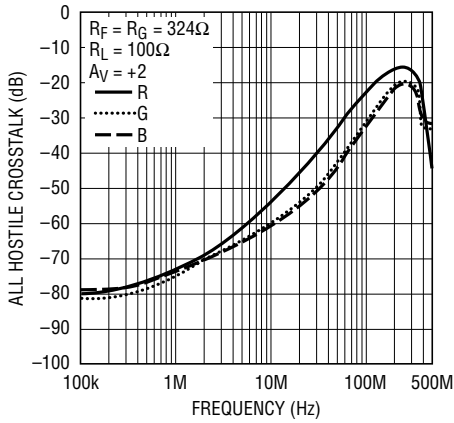

1398/1399 G21

**All Hostile Crosstalk (Disabled)**

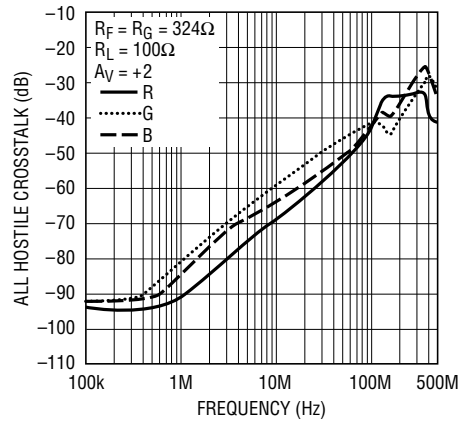

1398/1399 G24

**Propagation Delay**

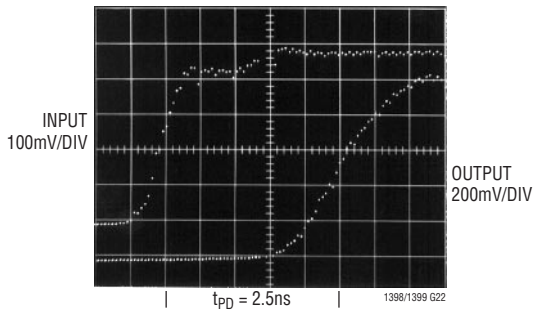

1398/1399 G22

$t_{PD} = 2.5\text{ns}$   
 TIME (500ps/DIV)  
 $A_V = +2$   
 $R_L = 100\Omega$   
 $R_F = R_G = 324\Omega$

**Rise Time and Overshoot**

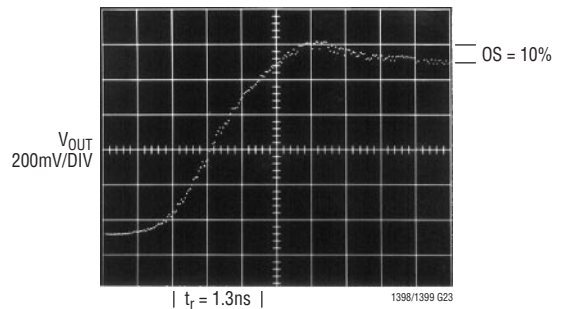

1398/1399 G23

$t_r = 1.3\text{ns}$   
 TIME (500ps/DIV)  
 $A_V = +2$   
 $R_L = 100\Omega$   
 $R_F = R_G = 324\Omega$



## PIN FUNCTIONS

### LT1398

- IN A (Pin 1): Inverting Input of A Channel Amplifier.
- +IN A (Pin 2): Noninverting Input of A Channel Amplifier.
- GND (Pins 3, 4, 5, 6): Ground. Not connected internally.
- +IN B (Pin 7): Noninverting Input of B Channel Amplifier.
- IN B (Pin 8): Inverting Input of B Channel Amplifier.
- $\overline{\text{EN B}}$  (Pin 9): B Channel Enable Pin. Logic low to enable.
- OUT B (Pin 10): B Channel Output.
- V<sup>–</sup> (Pin 11): Negative Supply Voltage, Usually –5V.
- GND (Pins 12, 13): Ground. Not connected internally.
- V<sup>+</sup> (Pin 14): Positive Supply Voltage, Usually 5V.
- OUT A (Pin 15): A Channel Output.
- $\overline{\text{EN A}}$  (Pin 16): A Channel Enable Pin. Logic low to enable.

### LT1399, LT1399HV

- IN R (Pin 1): Inverting Input of R Channel Amplifier.
- +IN R (Pin 2): Noninverting Input of R Channel Amplifier.
- GND (Pin 3): Ground. Not connected internally.
- IN G (Pin 4): Inverting Input of G Channel Amplifier.
- +IN G (Pin 5): Noninverting Input of G Channel Amplifier.
- GND (Pin 6): Ground. Not connected internally.
- +IN B (Pin 7): Noninverting Input of B Channel Amplifier.
- IN B (Pin 8): Inverting Input of B Channel Amplifier.
- $\overline{\text{EN B}}$  (Pin 9): B Channel Enable Pin. Logic low to enable.
- OUT B (Pin 10): B Channel Output.
- V<sup>–</sup> (Pin 11): Negative Supply Voltage, Usually –5V.
- OUT G (Pin 12): G Channel Output.
- $\overline{\text{EN G}}$  (Pin 13): G Channel Enable Pin. Logic low to enable.
- V<sup>+</sup> (Pin 14): Positive Supply Voltage, Usually 5V.
- OUT R (Pin 15): R Channel Output.
- $\overline{\text{EN R}}$  (Pin 16): R Channel Enable Pin. Logic low to enable.

## APPLICATIONS INFORMATION

### Feedback Resistor Selection

The small-signal bandwidth of the LT1398/LT1399/LT1399HV is set by the external feedback resistors and the internal junction capacitors. As a result, the bandwidth is a function of the supply voltage, the value of the feedback resistor, the closed-loop gain and the load resistor. The LT1398/LT1399 have been optimized for  $\pm 5\text{V}$  supply operation and have a –3dB bandwidth of 300MHz at a gain of 2. The LT1399HV provides performance similar to the LT1399. Please refer to the resistor selection guide in the Typical AC Performance table.

### Capacitance on the Inverting Input

Current feedback amplifiers require resistive feedback from the output to the inverting input for stable operation.

Take care to minimize the stray capacitance between the output and the inverting input. Capacitance on the inverting input to ground will cause peaking in the frequency response (and overshoot in the transient response).

### Capacitive Loads

The LT1398/LT1399/LT1399HV can drive many capacitive loads directly when the proper value of feedback resistor is used. The required value for the feedback resistor will increase as load capacitance increases and as closed-loop gain decreases. Alternatively, a small resistor ( $5\Omega$  to  $35\Omega$ ) can be put in series with the output to isolate the capacitive load from the amplifier output. This has the advantage that the amplifier bandwidth is only reduced when the capacitive load is present. The disadvantage is that the gain is a function of the load resistance.

## APPLICATIONS INFORMATION

### Power Supplies

The LT1398/LT1399 will operate from single or split supplies from  $\pm 2V$  (4V total) to  $\pm 6V$  (12V total). The LT1399HV will operate from single or split supplies from  $\pm 2V$  (4V total) to  $\pm 7.5V$  (15V total). It is not necessary to use equal value split supplies, however the offset voltage and inverting input bias current will change. The offset voltage changes about  $600\mu V$  per volt of supply mismatch. The inverting bias current will typically change about  $2\mu A$  per volt of supply mismatch.

### Slew Rate

Unlike a traditional voltage feedback op amp, the slew rate of a current feedback amplifier is not independent of the amplifier gain configuration. In a current feedback amplifier, both the input stage and the output stage have slew rate limitations. In the inverting mode, and for gains of 2 or more in the noninverting mode, the signal amplitude between the input pins is small and the overall slew rate is that of the output stage. For gains less than 2 in the noninverting mode, the overall slew rate is limited by the input stage.

The input slew rate of the LT1398/LT1399/LT1399HV is approximately  $600V/\mu s$  and is set by internal currents and capacitances. The output slew rate is set by the value of the feedback resistor and internal capacitance. At a gain of 2 with  $324\Omega$  feedback and gain resistors and  $\pm 5V$  supplies, the output slew rate is typically  $800V/\mu s$ . Larger feedback resistors will reduce the slew rate as will lower supply voltages.

### Enable/Disable

Each amplifier of the LT1398/LT1399/LT1399HV has a unique high impedance, zero supply current mode which is controlled by its own  $\overline{EN}$  pin. These amplifiers are designed to operate with CMOS logic; the amplifiers draw zero current when these pins are high. To activate each amplifier, its  $\overline{EN}$  pin is normally pulled to a logic low. However, supply current will vary as the voltage between the  $V^+$  supply and  $\overline{EN}$  is varied. As seen in Figure 1,  $+I_S$  does vary with  $(V^+ - V_{\overline{EN}})$ , particularly when the voltage difference is less than  $3V$ . For normal operation, it is important to keep the  $\overline{EN}$  pin at least  $3V$  below the  $V^+$  supply. If a  $V^+$  of less than  $3V$  is desired, and the amplifier

will remain enabled at all times, then the  $\overline{EN}$  pin should be tied to the  $V^-$  supply. The enable pin current is approximately  $30\mu A$  when activated. If using CMOS open-drain logic, an external  $1k$  pull-up resistor is recommended to ensure that the LT1399 remains disabled in spite of any CMOS drain-leakage currents.

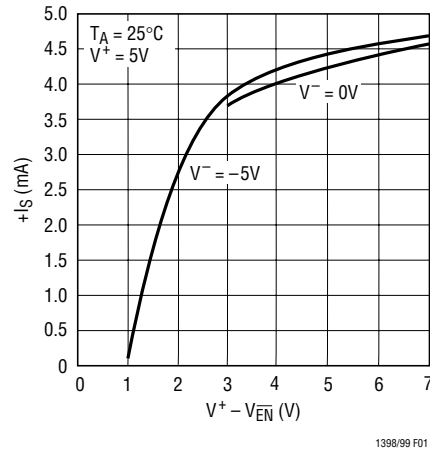

Figure 1.  $+I_S$  vs  $(V^+ - V_{\overline{EN}})$



Figure 2. Amplifier Enable Time,  $A_V = 2$



Figure 3. Amplifier Disable Time,  $A_V = 2$

## APPLICATIONS INFORMATION

The enable/disable times are very fast when driven from standard 5V CMOS logic. Each amplifier enables in about 30ns (50% point to 50% point) while operating on  $\pm 5V$  supplies (Figure 2). Likewise, the disable time is approximately 40ns (50% point to 50% point) (Figure 3).

### Differential Input Signal Swing

To avoid any breakdown condition on the input transistors, the differential input swing must be limited to  $\pm 5V$ . In normal operation, the differential voltage between the input pins is small, so the  $\pm 5V$  limit is not an issue. In the disabled mode however, the differential swing can be the same as the input swing, and there is a risk of device breakdown if input voltage range has not been properly considered.

### 3-Input Video MUX Cable Driver

The application on the first page of this data sheet shows a low cost, 3-input video MUX cable driver. The scope photo below (Figure 4) displays the cable output of a 30MHz square wave driving  $150\Omega$ . In this circuit the active amplifier is loaded by the sum of  $R_F$  and  $R_G$  of each disabled amplifier. Resistor values have been chosen to keep the total back termination at  $75\Omega$  while maintaining a gain of 1 at the  $75\Omega$  load. The switching time between any two channels is approximately 32ns when both enable pins are driven.

When building the board, care was taken to minimize trace lengths at the inverting input. The ground plane was also pulled away from  $R_F$  and  $R_G$  on both sides of the board to minimize stray capacitance.



Figure 4. Square Wave Response

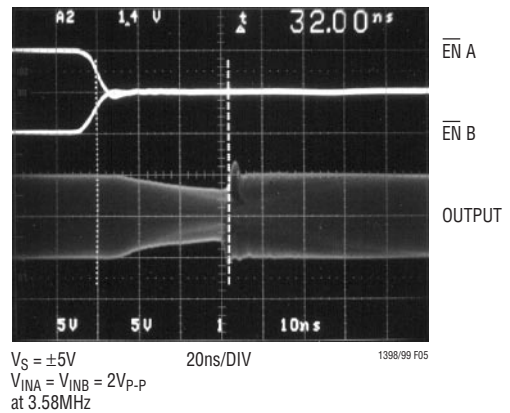

Figure 5. 3-Input Video MUX Switching Response ( $A_V = 2$ )

### Using the LT1399 to Drive LCD Displays

Driving the current crop of XGA and UXGA LCD displays can be a difficult problem because they require drive voltages of up to 12V, are usually a capacitive load of over 300pF, and require fast settling. The LT1399HV is particularly well suited for driving these LCD displays because it is capable of swinging more than  $\pm 6V$  on  $\pm 7.5V$  supplies, and it can drive large capacitive loads with a small series resistor at the output, minimizing settling time. As seen in Figures 6 and 7, at a gain of +3 with a  $16.9\Omega$  output series resistor and a 330pF load, the LT1399HV is capable of settling to 0.1% in 30ns for a 6V step. Similarly, a 12V output step settles in 70ns.

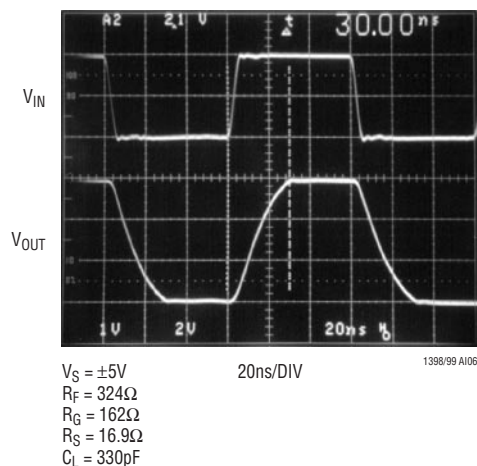

Figure 6. LT1399/LT1399HV Large-Signal Pulse Response

APPLICATIONS INFORMATION



Figure 7. LT1399HV Output Voltage Swing

Buffered RGB to Color-Difference Matrix

Two LT1398s can be used to create buffered color-difference signals from RGB inputs (Figure 8). In this application, the R input arrives via 75Ω coax. It is routed to the noninverting input of LT1398 amplifier A1 and to a 1082Ω resistor R8. There is also an 80.6Ω termination

resistor R11, which yields a 75Ω input impedance at the R input when considered in parallel with R8. R8 connects to the inverting input of a second LT1398 amplifier (A2), which also sums the weighted G and B inputs to create a  $-0.5 \cdot Y$  output. LT1398 amplifier B1 then takes the  $-0.5 \cdot Y$  output and amplifies it by a gain of  $-2$ , resulting in the Y output. Amplifier A1 is configured in a noninverting gain of 2 with the bottom of the gain resistor R2 tied to the Y output. The output of amplifier A1 thus results in the color-difference output R-Y.

The B input is similar to the R input. It arrives via 75Ω coax, and is routed to the noninverting input of LT1398 amplifier B2, and to a 2940Ω resistor R10. There is also a 76.8Ω termination resistor R13, which yields a 75Ω input impedance when considered in parallel with R10. R10 also connects to the inverting input of amplifier A2, adding the B contribution to the Y signal as discussed above. Amplifier B2 is configured in a noninverting gain of 2 configuration with the bottom of the gain resistor R4 tied to the Y output. The output of amplifier B2 thus results in the color-difference output B-Y.



Figure 8. Buffered RGB to Color-Difference Matrix



## APPLICATIONS INFORMATION

The G input also arrives via 75Ω coax and adds its contribution to the Y signal via a 549Ω resistor R9, which is tied to the inverting input of amplifier A2. There is also an 86.6Ω termination resistor R12, which yields a 75Ω termination when considered in parallel with R9. Using superposition, it is straightforward to determine the output of amplifier A2. Although inverted, it sums the R, G and B signals in the standard proportions of 0.3R, 0.59G and 0.11B that are used to create the Y signal. Amplifier B1 then inverts and amplifies the signal by 2, resulting in the Y output.

### Buffered Color-Difference to RGB Matrix

The LT1399 can be used to create buffered RGB outputs from color-difference signals (Figure 9). The R output is a back-terminated 75Ω signal created using resistor R5 and LT1399 amplifier A1 configured for a gain of +2 via 324Ω resistors R3 and R4. The noninverting input of amplifier A1 is connected via 1k resistors R1 and R2 to the Y and R-Y inputs respectively, resulting in cancellation of the Y signal at the amplifier input. The remaining R signal is then amplified by A1.

The B output is also a back-terminated 75Ω signal created using resistor R16 and amplifier A3 configured for a gain of +2 via 324Ω resistors R14 and R15. The noninverting input of amplifier A3 is connected via 1k resistors R12 and R13 to the Y and B-Y inputs respectively, resulting in cancellation of the Y signal at the amplifier input. The remaining B signal is then amplified by A3.

The G output is the most complicated of the three. It is a weighted sum of the Y, R-Y and B-Y inputs. The Y input is attenuated via resistors R6 and R7 such that amplifier A2's noninverting input sees 0.83Y. Using superposition, we can calculate the positive gain of A2 by assuming that R8 and R9 are grounded. This results in a gain of 2.41 and a contribution at the output of A2 of 2Y. The R-Y input is amplified by A2 with the gain set by resistors R8 and R10, giving an amplification of -1.02. This results in a contribution at the output of A2 of 1.02Y - 1.02R. The B-Y input is amplified by A2 with the gain set by resistors R9 and

R10, giving an amplification of -0.37. This results in a contribution at the output of A2 of 0.37Y - 0.37B.

If we now sum the three contributions at the output of A2, we get:

$$A2_{OUT} = 3.40Y - 1.02R - 0.37B$$

It is important to remember though that Y is a weighted sum of R, G and B such that:

$$Y = 0.3R + 0.59G + 0.11B$$

If we substitute for Y at the output of A2 we then get:

$$A2_{OUT} = (1.02R - 1.02R) + 2G + (0.37B - 0.37B) = 2G$$

The back-termination resistor R11 then halves the output of A2 resulting in the G output.



Figure 9. Buffered Color-Difference to RGB Matrix

**SIMPLIFIED SCHEMATIC**, each amplifier

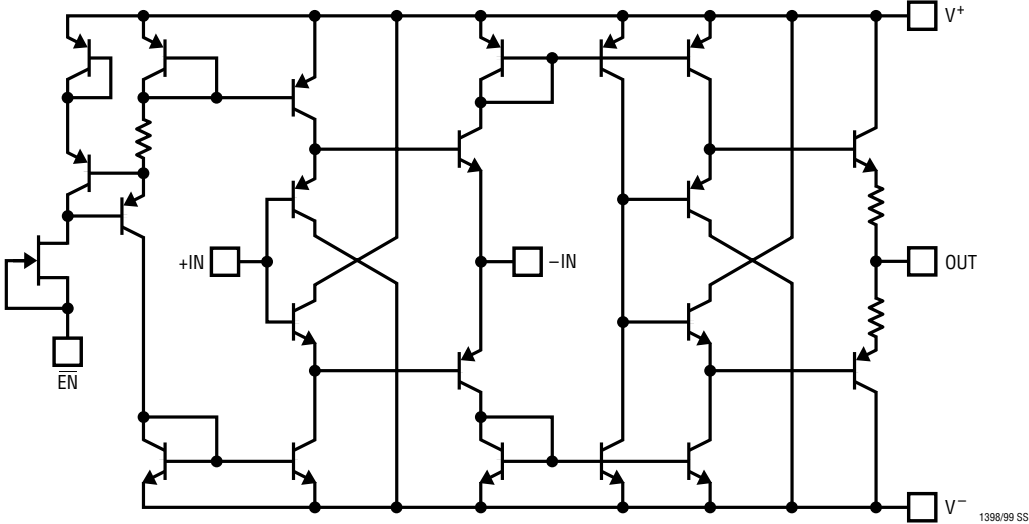

**PACKAGE DESCRIPTION** Dimensions in inches (millimeters) unless otherwise noted.

**GN Package**  
**16-Lead Plastic SSOP (Narrow 0.150)**  
 (LTC DWG # 05-08-1641)

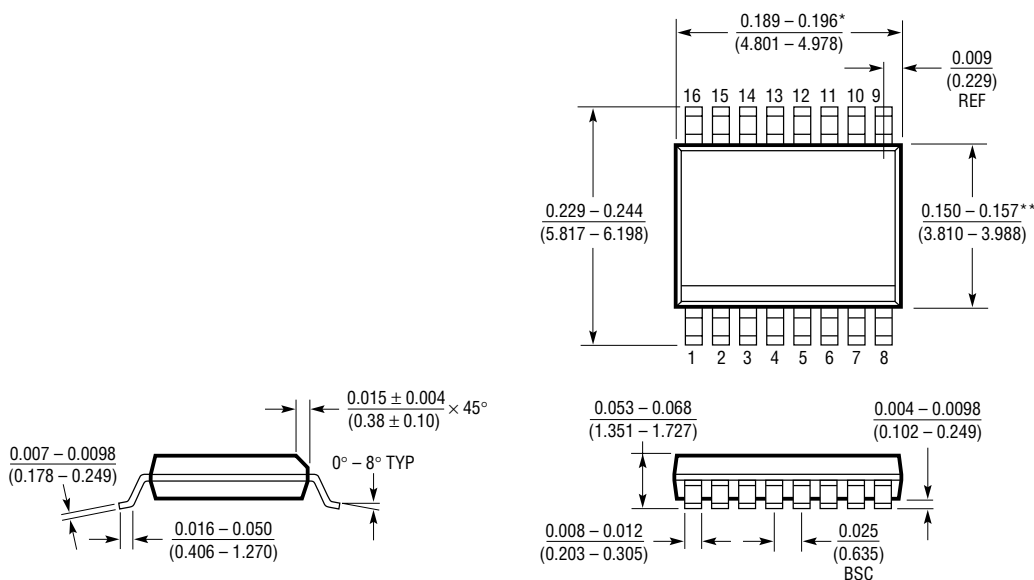

\* DIMENSION DOES NOT INCLUDE MOLD FLASH. MOLD FLASH SHALL NOT EXCEED 0.006" (0.152mm) PER SIDE  
 \*\* DIMENSION DOES NOT INCLUDE INTERLEAD FLASH. INTERLEAD FLASH SHALL NOT EXCEED 0.010" (0.254mm) PER SIDE

GN16 (SSOP) 0398

**S Package**  
**16-Lead Plastic Small Outline (Narrow 0.150)**  
 (LTC DWG # 05-08-1610)

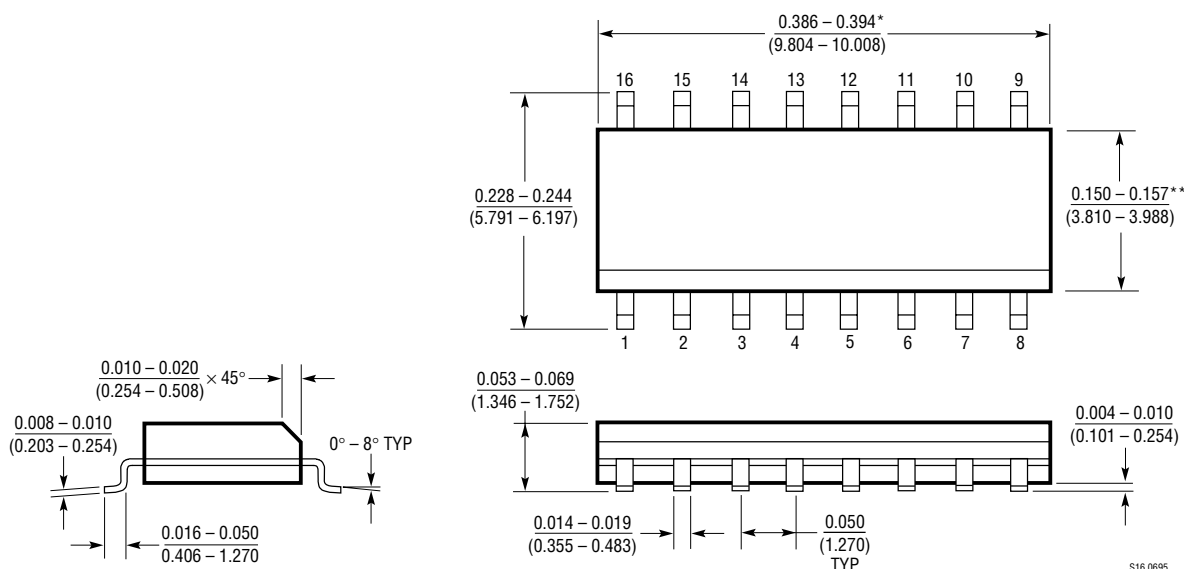

\* DIMENSION DOES NOT INCLUDE MOLD FLASH. MOLD FLASH SHALL NOT EXCEED 0.006" (0.152mm) PER SIDE  
 \*\* DIMENSION DOES NOT INCLUDE INTERLEAD FLASH. INTERLEAD FLASH SHALL NOT EXCEED 0.010" (0.254mm) PER SIDE

S16 0695

sn13989 13989fas



## TYPICAL APPLICATION

### Single Supply RGB Video Amplifier

The LT1399 can be used with a single supply voltage of 6V or more to drive ground-referenced RGB video. In Figure 10, two 1N4148 diodes D1 and D2 have been placed in series with the output of the LT1399 amplifier A1 but within the feedback loop formed by resistor R8. These diodes effectively level-shift A1's output downward by 2 diodes, allowing the circuit output to swing to ground.

Amplifier A1 is used in a positive gain configuration. The feedback resistor R8 is 324Ω. The gain resistor is created from the parallel combination of R6 and R7, giving a Thevenin equivalent 80.4Ω connected to 3.75V. This gives an AC gain of +5 from the noninverting input of amplifier A1 to the cathode of D2. However, the video input is also attenuated before arriving at A1's positive

input. Assuming a 75Ω source impedance for the signal driving  $V_{IN}$ , the Thevenin equivalent signal arriving at A1's positive input is  $3V + 0.4V_{IN}$ , with a source impedance of 714Ω. The combination of these two inputs gives an output at the cathode of D2 of  $2 \cdot V_{IN}$  with no additional DC offset. The 75Ω back termination resistor R9 halves the signal again such that  $V_{OUT}$  equals a buffered version of  $V_{IN}$ .

It is important to note that the 4.7μF capacitor C1 has been added to provide enough current to maintain the voltage drop across diodes D1 and D2 when the circuit output drops low enough that the diodes might otherwise reverse bias. This means that this circuit works fine for continuous video input, but will require that C1 charge up after a period of inactivity at the input.

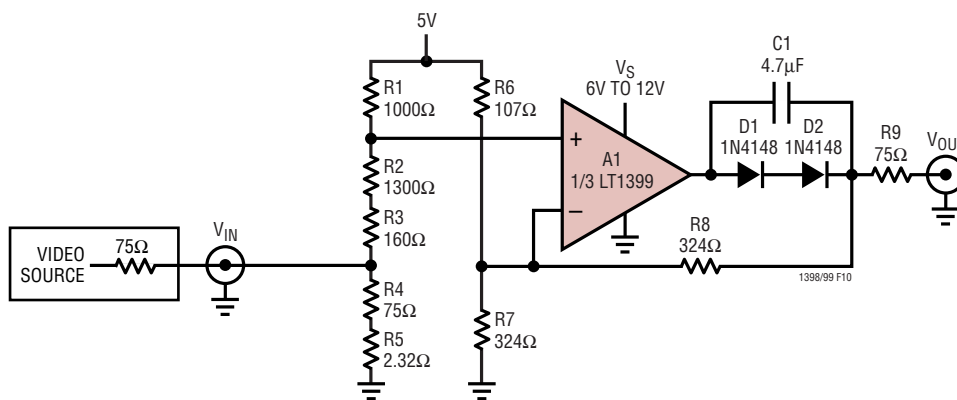

Figure 10. Single Supply RGB Video Amplifier (1 of 3 Channels)

## RELATED PARTS

PART NUMBER	DESCRIPTION	COMMENTS
LT1203/LT1205	150MHz Video Multiplexers	2:1 and Dual 2:1 MUXs with 25ns Switch Time
LT1204	4-Input Video MUX with Current Feedback Amplifier	Cascadable Enable 64:1 Multiplexing
LT1227	140MHz Current Feedback Amplifier	1100V/μs Slew Rate, Shutdown Mode
LT1252/LT1253/LT1254	Low Cost Video Amplifiers	Single, Dual and Quad Current Feedback Amplifiers
LT1259/LT1260	Dual/Triple Current Feedback Amplifier	130MHz Bandwidth, 0.1dB Flatness >30MHz
LT1395/LT1396/LT1397	Single/Dual/Quad Current Feedback Amplifiers	400MHz Bandwidth, 0.1dB Flatness >100MHz
LT1675/LT1675-1	Triple/Single 2:1 Buffered Video Multiplexer	2.5ns Switching Time, 250MHz Bandwidth
LT1806/LT1807	Single/Dual 325MHz Rail-to-Rail In/Out Op Amp	Low Distortion, Low Noise
LT1809/LT1810	Single/Dual 180MHz Rail-to-Rail In/Out Op Amp	350V/μs, Low Distortion

sn13989 13989fas

## X-ON Electronics

Largest Supplier of Electrical and Electronic Components

*Click to view similar products for [High Speed Operational Amplifiers](#) category:*

*Click to view products by [Analog Devices](#) manufacturer:*

Other Similar products are found below :

[NJU7047RB1-TE2](#) [LTC6226IS8#PBF](#) [LTC6226HS8#PBF](#) [LT1058ACN](#) [LT1206CR](#) [LT1058ISW](#) [THS4222DGNR](#) [OPA2677IDDAR](#)  
[THS6042ID](#) [THS4221DBVR](#) [THS4081CD](#) [ADA4858-3ACPZ-R7](#) [LT6202IS5#TRMPBF](#) [LT1206CR#PBF](#) [LTC6253CMS8#PBF](#)  
[LT1813CDD#PBF](#) [ADA4851-4YRUZ-RL](#) [LT1037IN8#PBF](#) [LTC6401CUD-20#PBF](#) [LT1192CN8#PBF](#) [LTC6401IUD-26#PBF](#)  
[LT1037ACN8#PBF](#) [LTC6253CTS8#TRMPBF](#) [LT1399HVCS#PBF](#) [LT1993CUD-2#PBF](#) [LT6203CDD#PBF](#) [LT1722CS8#PBF](#)  
[LT1208CN8#PBF](#) [LT1222CN8#PBF](#) [LT6203IDD#PBF](#) [LT6411IUD#PBF](#) [LTC6400CUD-26#PBF](#) [LTC6400CUD-8#PBF](#) [LT6211IDD#PBF](#)  
[OP27EN8#PBF](#) [LT1810IMS8#PBF](#) [OP37EN8#PBF](#) [LTC6253IMS8#PBF](#) [LT1360CS8](#) [OPA2132PAG4](#) [OPA2691I-14D](#) [OPA4353UA/2K5](#)  
[OPA690IDRG4](#) [LMH6723MFX/NOPB](#) [5962-9151901MPA](#) [ADP5302ACPZ-3-R7](#) [AD8007AKSZ-REEL7](#) [AD8008ARMZ](#) [AD8009JRTZ-](#)  
[REEL7](#) [AD8010ANZ](#)