

# Micropower Rail-to-Rail Op Amp and Reference

## FEATURES

- **Guaranteed Operation at 1.2V**
- **Op Amp and Reference on Single Chip**
- **Micropower: 130 $\mu$ A Supply Current**
- Industrial Temperature Range SO-8 Packages
- Rail-to-Rail Output
- High Output Current: 20mA Min
- Output Drives 1000pF
- Capable of Floating Mode Operation
- Specified for 5V and  $\pm$ 5V Supplies
- Low Reference Drift: 30ppm/ $^{\circ}$ C
- Industry Standard LM10 Pinout

## APPLICATIONS

- Battery- or Solar-Powered Systems
  - Portable Instrumentation
  - Sensor Conditioning
- Precision Current Regulators
- Precision Voltage Regulators
- Battery Level Indicator
- Thermocouple Transmitter

## DESCRIPTION

The LT<sup>®</sup>1635 is a new analog building block that includes a rail-to-rail output op amp, a precision reference and reference buffer. The device operates from supplies as low as a single 1.2V or up to  $\pm$ 5V, yet it consumes only 130 $\mu$ A of supply current.

The input common mode range of the op amp includes ground and incorporates phase reversal protection to prevent false outputs from occurring when the input is below the negative supply. The rail-to-rail output stage can swing to within 15mV of each rail with no load and can swing to within 250mV of each rail while delivering 10mA of output current. The gain bandwidth of the op amp is 175kHz and it is unity-gain stable with up to 1000pF load capacitance.

The 0.2V reference is referred to  $V^-$  and includes a buffer amplifier to enhance flexibility. The reference and buffer combine to achieve a drift of 30ppm/ $^{\circ}$ C, a line regulation of 20ppm/V and a load regulation of 150ppm/mA.

The LT1635 is available in 8-pin PDIP and SO packages, and has the industry standard LM10 pinout.

LT, LTC and LT are registered trademarks of Linear Technology Corporation.

## TYPICAL APPLICATION

0V to 5V Regulator

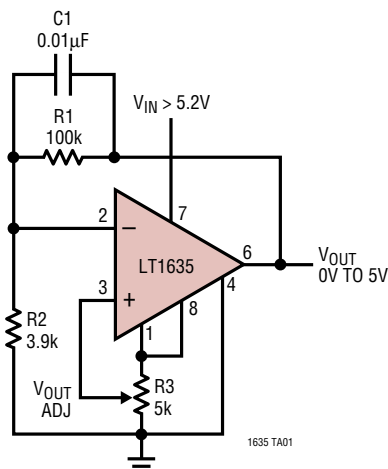

Typical Distribution of Input Offset Voltage

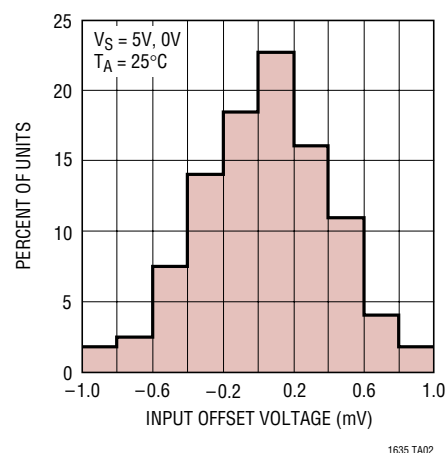

**ABSOLUTE MAXIMUM RATINGS**

(Note 1)

Total Supply Voltage ( $V^+$  to  $V^-$ ) ..... 14V  
 Input Differential Voltage ..... 14V  
 Input Current .....  $\pm 25\text{mA}$   
 Output Short-Circuit Duration ..... Continuous  
 Operating Temperature Range

(Note 2) .....  $-40^\circ\text{C}$  to  $85^\circ\text{C}$   
 Junction Temperature .....  $150^\circ\text{C}$   
 Storage Temperature Range .....  $-65^\circ\text{C}$  to  $150^\circ\text{C}$   
 Lead Temperature (Soldering, 10 sec) .....  $300^\circ\text{C}$

**PACKAGE/ORDER INFORMATION**

TOP VIEW

N8 PACKAGE 8-LEAD PDIP      S8 PACKAGE 8-LEAD PLASTIC SO

$T_{JMAX} = 150^\circ\text{C}$ ,  $\theta_{JA} = 130^\circ\text{C/W}$  (N8)  
 $T_{JMAX} = 150^\circ\text{C}$ ,  $\theta_{JA} = 190^\circ\text{C/W}$  (S8)

ORDER PART NUMBER

LT1635CN8  
 LT1635CS8  
 LT1635IN8  
 LT1635IS8

---

S8 PART MARKING

1635    1635I

Consult LTC Marketing for parts specified with wider operating temperature ranges.

**ELECTRICAL CHARACTERISTICS**

**5V OP AMP:** The ● denotes the specifications which apply over the full operating temperature range, otherwise specifications are at  $T_A = 25^\circ\text{C}$ .  $V_S = 5\text{V}$ ,  $0\text{V}$ ;  $V_{CM} = V_{OUT} = 2.5\text{V}$ , unless otherwise noted. (Note 2)

SYMBOL	PARAMETER	CONDITIONS	MIN	TYP	MAX	UNITS
$V_{OS}$	Input Offset Voltage	$0^\circ\text{C} \leq T_A \leq 70^\circ\text{C}$	●	0.3	1.3	mV
		$-40^\circ\text{C} \leq T_A \leq 85^\circ\text{C}$	●	0.5	1.6	mV
						1.8
	Input Offset Voltage Drift	$-40^\circ\text{C} \leq T_A \leq 85^\circ\text{C}$ (Note 4)	●	3.0	7.0	$\mu\text{V}/^\circ\text{C}$
$V_{OS\ ADJ}$	Offset Voltage Adjust Range	Positive Adjust	●	6	8	mV
		Negative Adjust	●	-1.4	-2	mV
$I_{OS}$	Input Offset Current		●	0.2	0.6	nA
$I_B$	Input Bias Current		●	2.0	4.5	nA
				2.5	5.5	nA
	Input Noise Voltage	0.1Hz to 10Hz		1		$\mu\text{V}_{P-P}$
$e_n$	Input Noise Voltage Density	$f = 1\text{kHz}$		50		$\text{nV}/\sqrt{\text{Hz}}$
$i_n$	Input Noise Current Density	$f = 1\text{kHz}$		0.05		$\text{pA}/\sqrt{\text{Hz}}$
$R_{IN}$	Input Resistance	Differential	●	7	25	$\text{M}\Omega$
		Common Mode, $V_{CM} = 0\text{V}$ to $4\text{V}$			6	$\text{G}\Omega$
	Input Voltage Range		●	0	4	V
CMRR	Common Mode Rejection Ratio	$V_{CM} = 0\text{V}$ to $4\text{V}$	●	92	110	dB
				85	97	dB
$A_{VOL}$	Large-Signal Voltage Gain	$V_O = 200\text{mV}$ to $4.5\text{V}$ , No Load	●	100	450	$\text{V}/\text{mV}$
		$V_O = 200\text{mV}$ to $4.5\text{V}$ , $R_L = 1.1\text{k}$	●	45	200	$\text{V}/\text{mV}$
		$V_O = 200\text{mV}$ to $4.5\text{V}$ , $R_L = 500\Omega$	●	35	150	$\text{V}/\text{mV}$
	Shunt Gain	$I_{OUT} = 0.1\text{mA}$ to $5\text{mA}$ $V_O = 1.5\text{V}$ to $6.45\text{V}$ (Note 5)	●	15	25	$\text{V}/\text{mV}$
				8	20	$\text{V}/\text{mV}$
$V_{OL}$	Output Voltage Swing Low	$V_S = 5\text{V}$ , No Load	●	2	10	mV
		$V_S = 5\text{V}$ , $I_{SINK} = 5\text{mA}$	●	125	250	mV
		$V_S = 5\text{V}$ , $I_{SINK} = 10\text{mA}$	●	200	500	mV
$V_{OH}$	Output Voltage Swing High	$V_S = 5\text{V}$ , No Load	●	4.975	4.985	V
		$V_S = 5\text{V}$ , $I_{SOURCE} = 5\text{mA}$	●	4.65	4.8	V
		$V_S = 5\text{V}$ , $I_{SOURCE} = 10\text{mA}$	●	4.55	4.75	V

## ELECTRICAL CHARACTERISTICS

**5V OP AMP:** The ● denotes the specifications which apply over the full operating temperature range, otherwise specifications are at  $T_A = 25^\circ\text{C}$ .  $V_S = 5\text{V}$ ,  $0\text{V}$ ;  $V_{\text{CM}} = V_{\text{OUT}} = 2.5\text{V}$ , unless otherwise noted. (Note 2)

SYMBOL	PARAMETER	CONDITIONS		MIN	TYP	MAX	UNITS
$I_{\text{SC}}$	Short-Circuit Current	$V_S = 5\text{V}$ , Short to GND $V_S = 5\text{V}$ , Short to $V_{\text{CC}}$	●	20	40		mA
			●	20	40		mA
PSRR	Power Supply Rejection Ratio	$V_S = 1.2\text{V}$ to $12\text{V}$ , $V_{\text{CM}} = V_O = 0.2\text{V}$	●	93	100		dB
				90	97		dB
	Minimum Operating Supply Voltage	(Note 3)	●		1.1	1.2	V
$I_S$	Supply Current		●		130	200	$\mu\text{A}$
					150	260	$\mu\text{A}$
GBW	Gain Bandwidth Product	$f = 1\text{kHz}$			175		kHz
SR	Slew Rate	$A_V = -1$ , $R_L = \infty$			0.045		V/ $\mu\text{s}$

**5V REFERENCE:** The ● denotes the specifications which apply over the full operating temperature range, otherwise specifications are at  $T_A = 25^\circ\text{C}$ .  $V_S = 5\text{V}$ ,  $0\text{V}$ , unless otherwise noted. (Note 2)

SYMBOL	PARAMETER	CONDITIONS		MIN	TYP	MAX	UNITS
$V_{\text{REF}}$	Feedback Sense Voltage	Voltage at Pin 1 with Pin 1 Connected to Pin 8 (Note 6)	●	189	200	211	mV
$\text{TC } V_{\text{REF}}$	Reference Drift	(Note 4)	●		30	100	ppm/ $^\circ\text{C}$
	Feedback Current	Current into Pin 8	●		3.5	10	nA
			●		5.0	15	nA
	Line Regulation	$0 \leq I_{\text{REF}} \leq 1\text{mA}$ , $V_{\text{REF}} = 200\text{mV}$ $V_S = 1.2\text{V}$ to $5\text{V}$ $V_S = 1.3\text{V}$ to $5\text{V}$ (Note 3)	●		20	100	ppm/V
					30	200	ppm/V
	Load Regulation	$I_{\text{REF}} = 0$ to $1\text{mA}$	●		150	300	ppm/mA
					200	500	ppm/mA
	Reference Amplifier Gain	$V_O = 0.2\text{V}$ to $3.5\text{V}$	●	45	90		V/mV
				25	50		V/mV

**$\pm 5\text{V}$  OP AMP:** The ● denotes the specifications which apply over the full operating temperature range, otherwise specifications are at  $T_A = 25^\circ\text{C}$ .  $V_S = \pm 5\text{V}$ ;  $V_{\text{CM}} = V_{\text{OUT}} = 0\text{V}$ , unless otherwise noted. (Note 2)

SYMBOL	PARAMETER	CONDITIONS		MIN	TYP	MAX	UNITS
$V_{\text{OS}}$	Input Offset Voltage	$0^\circ\text{C} \leq T_A \leq 70^\circ\text{C}$ $-40^\circ\text{C} \leq T_A \leq 85^\circ\text{C}$	●		0.3	1.5	mV
			●		0.5	1.9	mV
						2.1	mV
	Input Offset Voltage Drift	$0^\circ\text{C} \leq T_A \leq 85^\circ\text{C}$ (Note 4)	●		4.5	10.0	$\mu\text{V}/^\circ\text{C}$
$V_{\text{OS ADJ}}$	Offset Voltage Adjust Range	Positive Adjust Negative Adjust	●	6	8		mV
			●	-1.4	-2		mV
$I_{\text{OS}}$	Input Offset Current		●		0.2	0.6	nA
$I_B$	Input Bias Current		●		2.0	4.5	nA
					2.5	5.5	nA
	Input Noise Voltage	0.1Hz to 10Hz			1		$\mu\text{V}_{\text{p-p}}$
$e_n$	Input Noise Voltage Density	$f = 1\text{kHz}$			50		$\text{nV}/\sqrt{\text{Hz}}$
$i_n$	Input Noise Current Density	$f = 1\text{kHz}$			0.05		$\text{pA}/\sqrt{\text{Hz}}$
$R_{\text{IN}}$	Input Resistance	Differential Common Mode, $V_{\text{CM}} = -5\text{V}$ to $4\text{V}$	●	7	35		M $\Omega$
					9		G $\Omega$
	Input Voltage Range		●	-5		4	V
CMRR	Common Mode Rejection Ratio	$V_{\text{CM}} = -5\text{V}$ to $4\text{V}$	●	94	115		dB
				91	110		dB

## ELECTRICAL CHARACTERISTICS

**±5V OP AMP:** The ● denotes the specifications which apply over the full operating temperature range, otherwise specifications are at  $T_A = 25^\circ\text{C}$ .  $V_S = \pm 5\text{V}$ ;  $V_{CM} = V_{OUT} = 0\text{V}$ , unless otherwise noted. (Note 2)

SYMBOL	PARAMETER	CONDITIONS	MIN	TYP	MAX	UNITS
$A_{VOL}$	Large-Signal Voltage Gain	$V_O = -4.5\text{V to } 4.5\text{V}$ , No Load	●	175	300	V/mV
		$V_O = -4.5\text{V to } 4.5\text{V}$ , $R_L = 1.1\text{k}$	●	15	100	V/mV
		$V_O = -4.5\text{V to } 4.5\text{V}$ , $R_L = 500\Omega$	●	10	60	V/mV
$V_O$	Output Voltage Swing	$V_S = \pm 5\text{V}$ , No Load	●	±4.975	±4.985	mV
		$V_S = \pm 5\text{V}$ , $I_{SINK} = 5\text{mA}$	●	±4.65	±4.75	mV
		$V_S = \pm 5\text{V}$ , $I_{SINK} = 10\text{mA}$	●	±4.5	±4.6	mV
$I_{SC}$	Short-Circuit Current	$V_S = \pm 5\text{V}$		±20	±40	mA
PSRR	Power Supply Rejection Ratio	$V_S = \pm 1\text{V to } \pm 6\text{V}$ , $V_{CM} = V_O = 0\text{V}$		90	100	dB
			●	88	98	dB
$I_S$	Supply Current			135	215	μA
			●	160	280	μA
GBW	Gain Bandwidth Product	$f = 1\text{kHz}$		175		kHz
SR	Slew Rate	$A_V = -1$ , $R_L = \infty$		0.05		V/μs

**±5V REFERENCE:** The ● denotes the specifications which apply over the full operating temperature range, otherwise specifications are at  $T_A = 25^\circ\text{C}$ .  $V_S = \pm 5\text{V}$ , unless otherwise noted. (Note 2)

SYMBOL	PARAMETER	CONDITIONS	MIN	TYP	MAX	UNITS	
$V_{REF}$	Feedback Sense Voltage	Voltage at Pin 1 with Pin 1 Connected to Pin 8 (Note 6)	●	189	200	211	mV
TC $V_{REF}$	Reference Drift	(Note 4)	●	40	120	ppm/°C	
	Feedback Current	Current into Pin 8	●	3.5	10	nA	
				5.0	15	nA	
	Line Regulation	$0 \leq I_{REF} \leq 1\text{mA}$ , $V_{REF} = 200\text{mV}$ $V_S = \pm 0.6\text{V to } \pm 5\text{V}$ $V_S = \pm 0.65\text{V to } \pm 5\text{V}$ (Note 3)		20	100	ppm/V	
			●	30	200	ppm/V	
	Load Regulation	$I_{REF} = 0$ to 1mA		150	300	ppm/mA	
			●	200	500	ppm/mA	
	Reference Amplifier Gain	$V_O = 0.2\text{V to } 8.5\text{V}$ $V_S = 10\text{V}, 0\text{V}$		45	90	V/mV	
			●	25	50	V/mV	

**Note 1:** Absolute Maximum Ratings are those values beyond which the life of a device may be impaired.

**Note 2:** The LT1635C is guaranteed to operate over the commercial temperature range of  $0^\circ\text{C}$  to  $70^\circ\text{C}$ . It is designed, characterized and expected to meet these extended temperature limits, but is not tested at  $-40^\circ\text{C}$  and  $85^\circ\text{C}$ . The LT1635I is guaranteed to meet the industrial temperature range.

**Note 3:** The LT1635 op amp operates on a 1.2V supply over the full industrial temperature range with an input common mode voltage of 0V to 0.2V. The minimum supply voltage for the reference to operate properly over this temperature range is 1.3V.

**Note 4:** This parameter is not 100% tested. Temperature coefficient is measured by dividing the change in output voltage by specified temperature range.

**Note 5:** Shunt gain defines the operation in floating applications when the output is connected to the  $V^+$  terminal and input common mode is referred to  $V^-$ .

**Note 6:** If part is stored outside of the specified temperature range, the output may shift due to hysteresis.

# TYPICAL PERFORMANCE CHARACTERISTICS Op Amp

**Supply Current vs Supply Voltage**

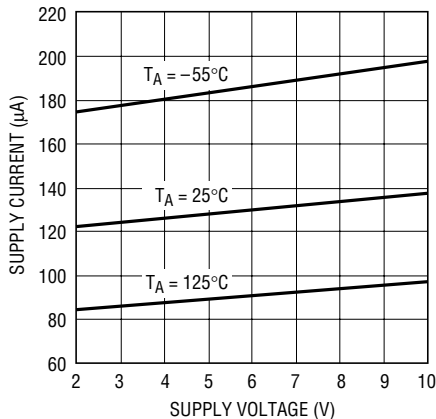

1635 G01

**Input Bias and Offset Currents vs Temperature**

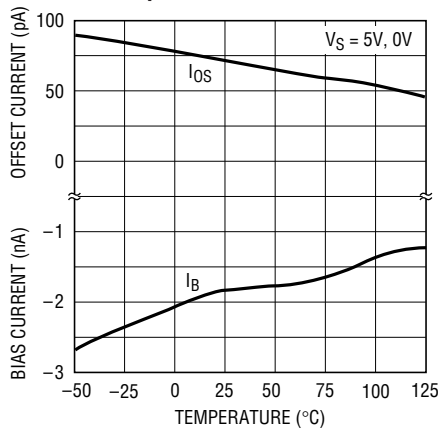

1635 G02

**Input Bias Current vs Common Mode Voltage**

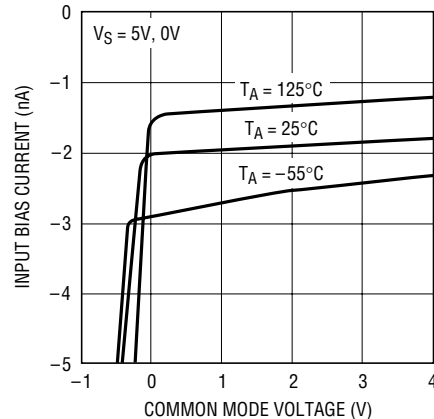

1635 G03

**0.1Hz to 10Hz Noise Voltage**

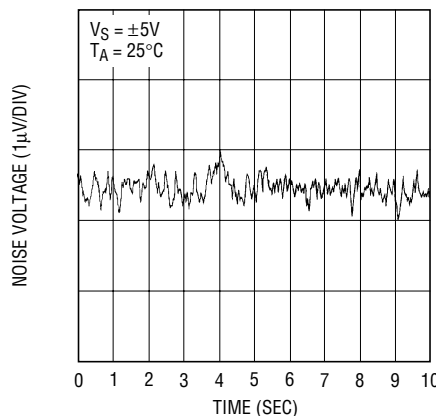

1635 G04

**Noise Voltage Density vs Frequency**

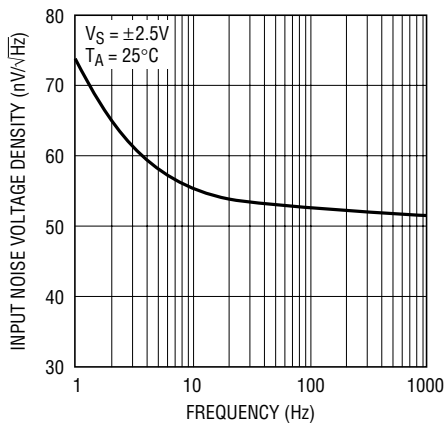

1635 G05

**Input Noise Current vs Frequency**

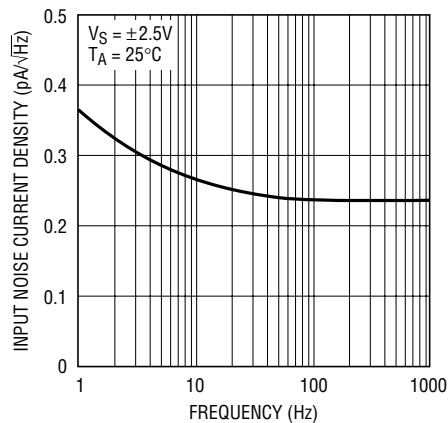

1635 G06

**Typical Distribution of Offset Voltage Drift with Temperature**

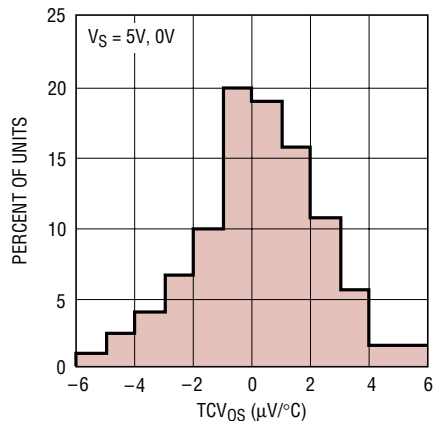

1635 G07

**Minimum Supply Voltage**

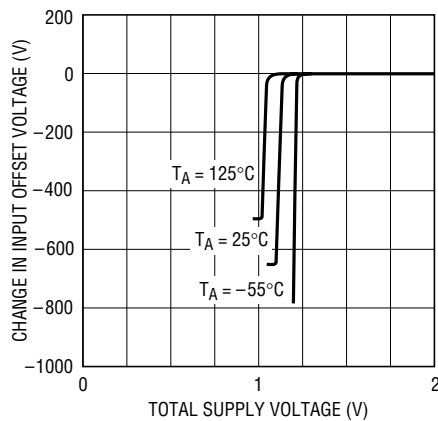

1635 G08

**Turn-On Drift of Three Typical Units**

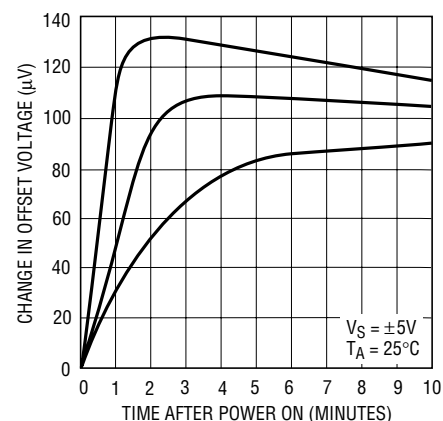

1635 G09

**TYPICAL PERFORMANCE CHARACTERISTICS** Op Amp

**Voltage Gain vs Frequency**

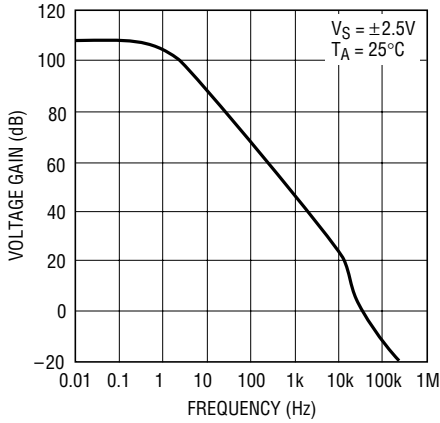

1635 G10

**Gain Phase vs Frequency**

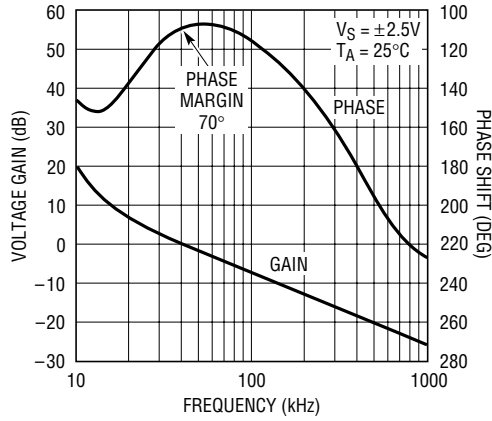

1635 G11

**Capacitive Load Handling**

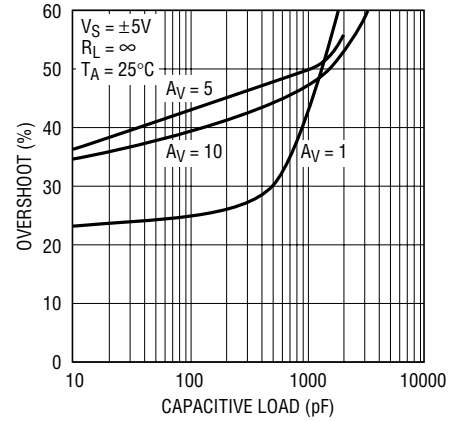

1635 G12

**Slew Rate vs Temperature**

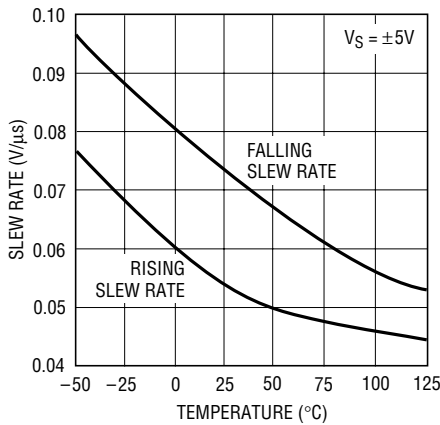

1635 G13

**Gain-Bandwidth Product and Phase Margin vs Temperature**

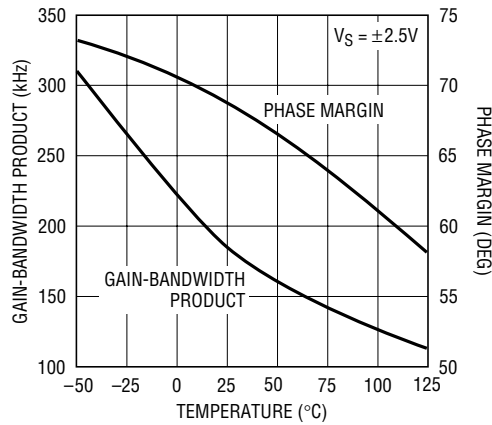

1635 G14

**Voltage Gain vs Load Resistance**

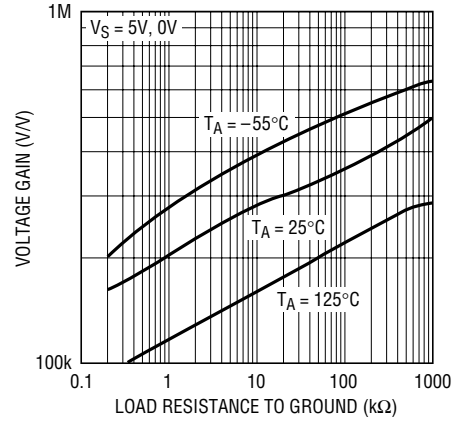

1635 G15

**Shunt Gain**

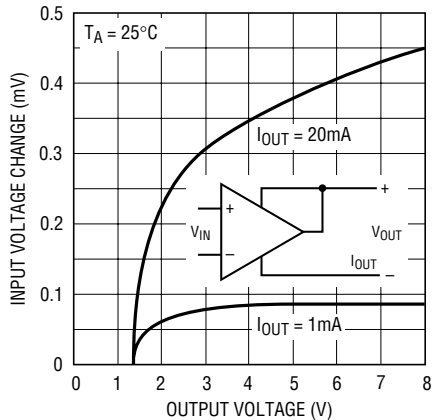

1635 G16

**Large-Signal Transient Response VS = ±5V**

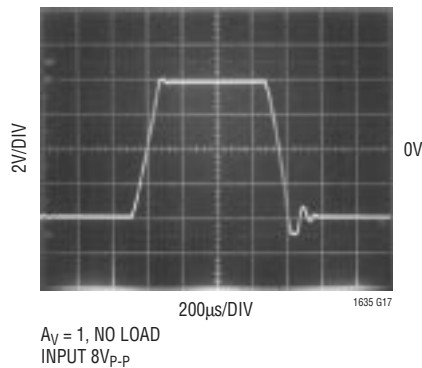

1635 G17

**Large-Signal Transient Response VS = 5V, 0V**

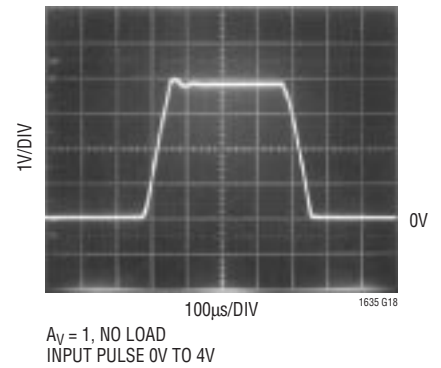

1635 G18

# TYPICAL PERFORMANCE CHARACTERISTICS Op Amp

**Output Saturation Voltage vs Input Overdrive**

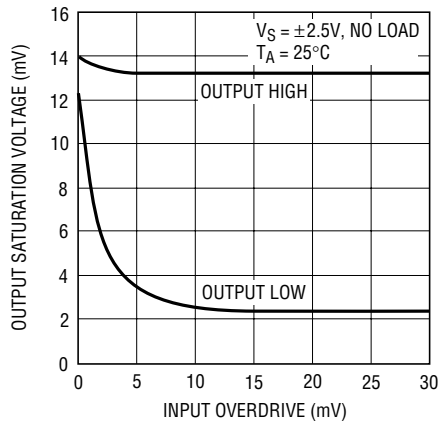

1635 G19

**Output Saturation Voltage vs Load Current (Output Low)**

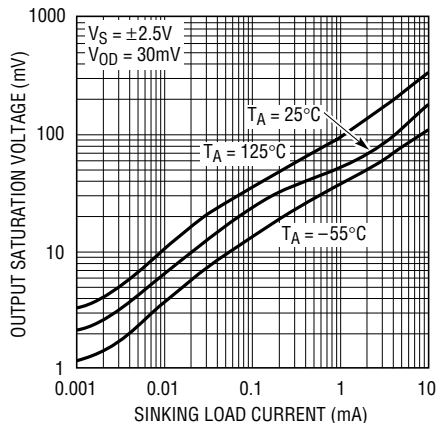

1635 G20

**Output Saturation Voltage vs Load Current (Output High)**

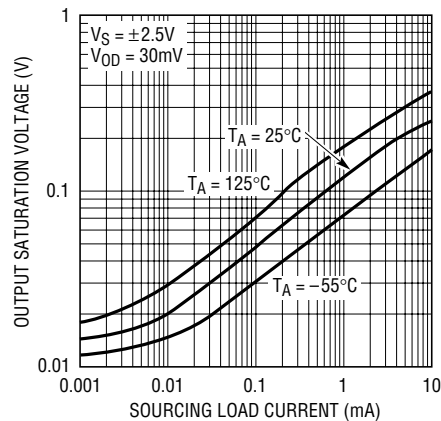

1635 G21

**Common Mode Range vs Temperature**

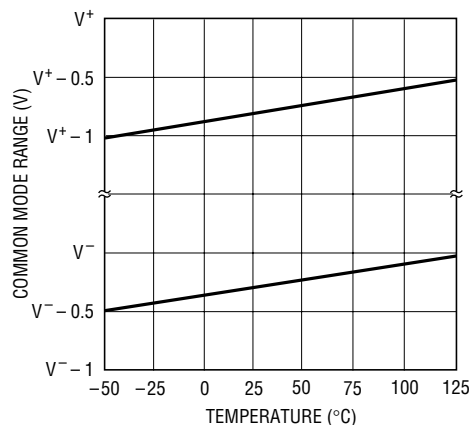

1635 G22

**Common Mode Rejection Ratio vs Frequency**

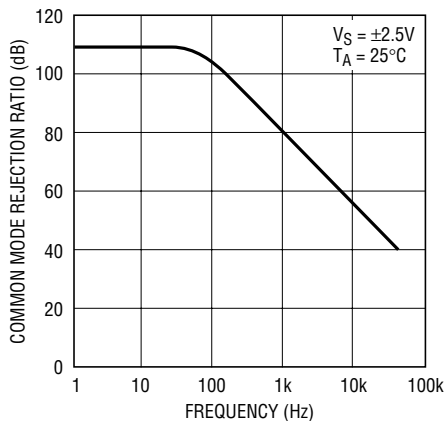

1635 G23

**Power Supply Rejection Ratio vs Frequency**

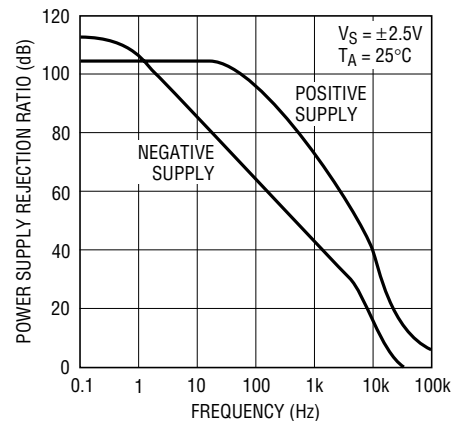

1635 G24

**Output Impedance vs Frequency**

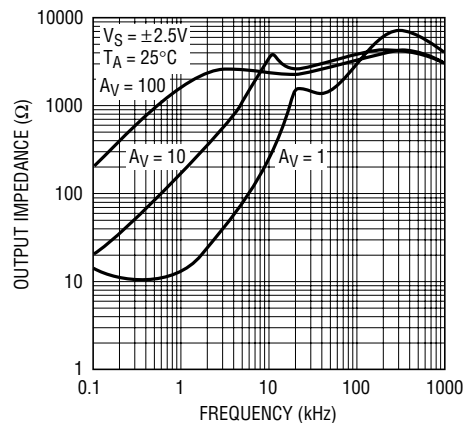

1635 G25

**Small-Signal Transient Response VS = ±5V**

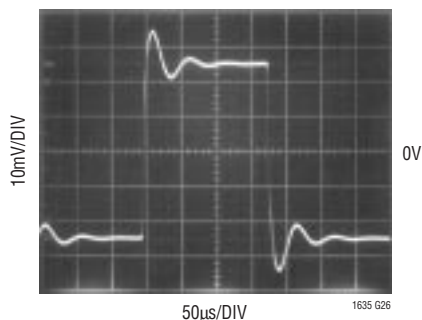

1635 G26

AV = 1  
CL = 15pF

**Small-Signal Transient Response VS = 5V, 0V**

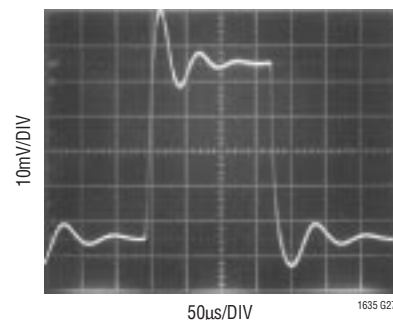

1635 G27

AV = 1  
CL = 15pF  
INPUT 50mV TO 100mV

**TYPICAL PERFORMANCE CHARACTERISTICS** Reference

**Typical Distribution of Initial Accuracy**

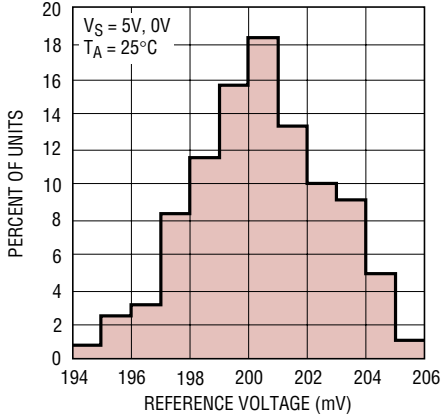

**Line Regulation**

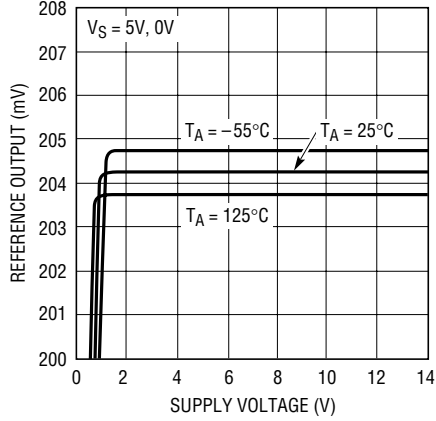

**Load Regulation**

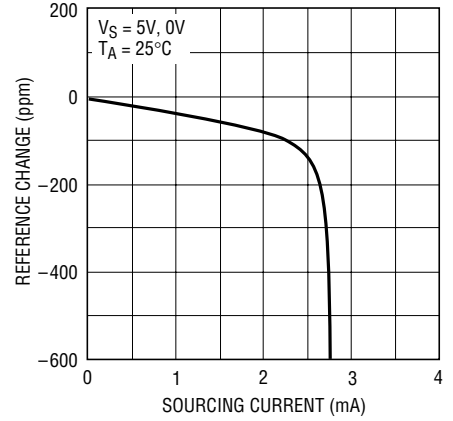

**Reference Output vs Temperature of Two Typical Units**

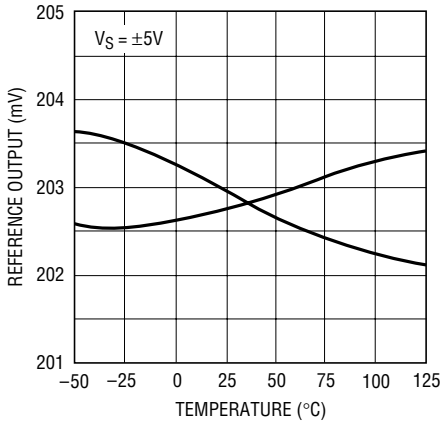

**Output Saturation vs Load Current (Sourcing)**

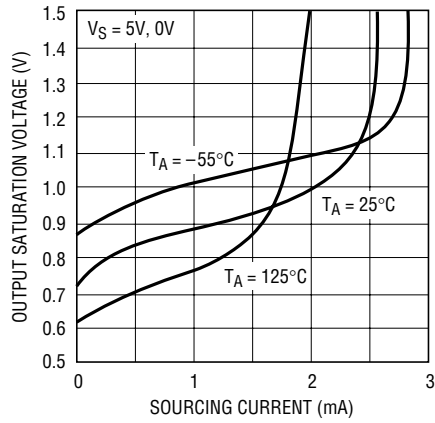

**Reference Amplifier Gain**

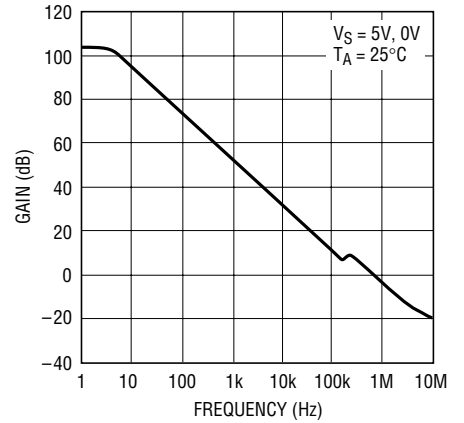

**BLOCK DIAGRAM**

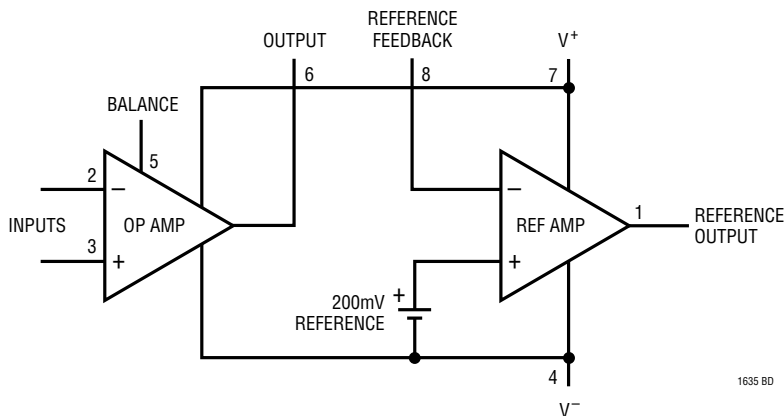



## APPLICATIONS INFORMATION

The LT1635 is fully specified with  $V^+ = 5V$ ,  $V^- = 0V$  and  $V_{CM} = 2.5V$ . The op amp offset voltage is internally trimmed to a minimum value at these supply voltages. A unique feature of this device is that it operates from a single 1.2V supply up to  $\pm 5V$ . A full set of specifications is provided at  $\pm 5V$  supply voltages. The positive supply pin of the LT1635 should be bypassed with a small capacitor (about  $0.1\mu F$ ), as well as the negative supply pin when using split supplies.

### Op Amp

The LT1635 is fully specified for single supply operation, i.e., when the negative supply is  $0V$ . Input common mode range of the op amp includes ground and the output swings within a few millivolts of ground while sinking current. The input stage of the op amp incorporates phase reversal protection to prevent false outputs from occurring when the input is below the negative supply. Protective resistors have been included in the input leads so that current does not become excessive when the inputs are forced below the negative supply.

The op amp also includes an offset nulling feature, this is accomplished by connecting the BALANCE pin (Pin 5) to a variable voltage derived from the reference output. The offset adjust range is asymmetrical, typically  $-2mV$  to  $8mV$ . At room temperature the input offset voltage of the LT1635 is within the null range, thus the offset voltage can be adjusted to zero. Figure 1 shows the standard offset adjustment.

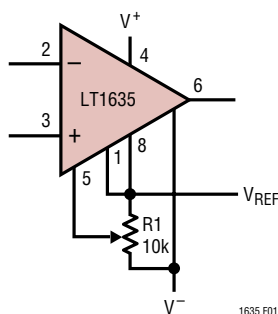

Figure 1. Standard Offset Adjustment

### Output

The output voltage swing of the LT1635 is a function of input overdrive as shown in the typical performance curves. When monitoring voltages within  $15mV$  of either rail, gain

should be taken to keep the output from saturating. For example, a  $1mV$  input signal will cause the amplifier to set up in its linear region in the gain 100 configuration as shown in Figure 2a. However,  $1mV$  is not enough to make the amplifier function properly in the voltage follower mode (Figure 2b).

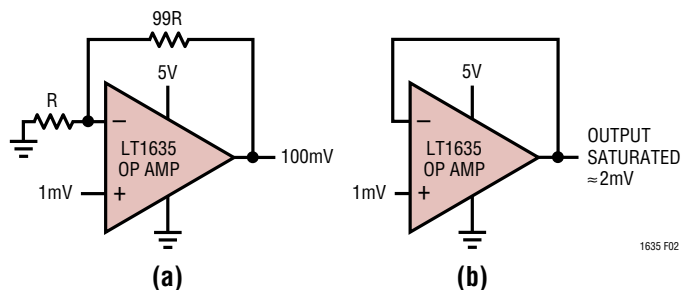

Figure 2. Gain 100 Amplifier and Voltage Follower

### Distortion

There are two main contributors of distortion in op amps: distortion caused by nonlinear common mode rejection and output crossover distortion as the output transitions from sourcing to sinking current. The common mode rejection ratio of the LT1635 is very good, typically  $110dB$ . Therefore, as long as the input operates in normal common mode range, there will be very little common mode induced distortion. Crossover distortion will increase as the output load resistance decreases. For the lowest distortion, the LT1635 should be operated with the output always sourcing current.

### Reference

The reference of the LT1635 consists of a  $200mV$  precision bandgap and a reference amplifier. As shown in the block diagram, the  $0.2V$  precision bandgap is referred to  $V^-$  and is internally connected to the noninverting input of the reference amplifier. This configuration offers great flexibility in that the reference voltage can be amplified or the reference amplifier can be used as a comparator. Unlike the op amp, the output of the reference amplifier can only swing within  $0.8V$  (typ) of the positive rail. To guarantee that the reference amplifier does not saturate over the industrial temperature range, the minimum operating supply should be  $1.3V$ . The reference amplifier can source  $2mA$  of load current and can sink  $10\mu A$  over the industrial temperature range.

TYPICAL APPLICATIONS

Low Voltage Regulator

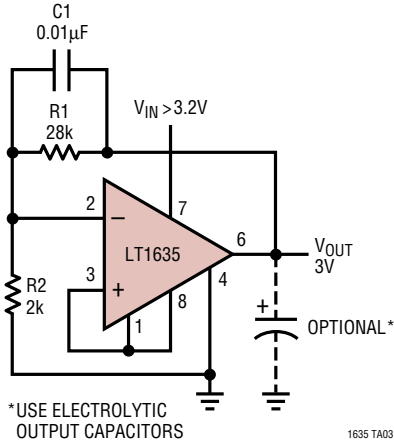

Best Regulation

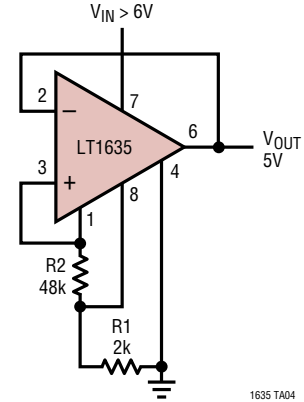

2-Terminal Current Regulator

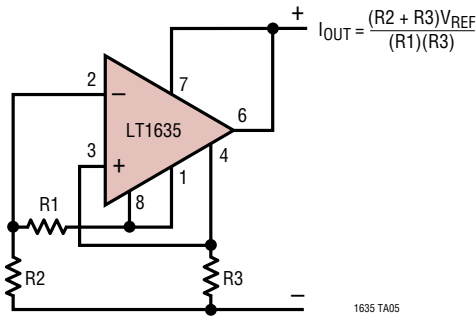

Shunt Regulator

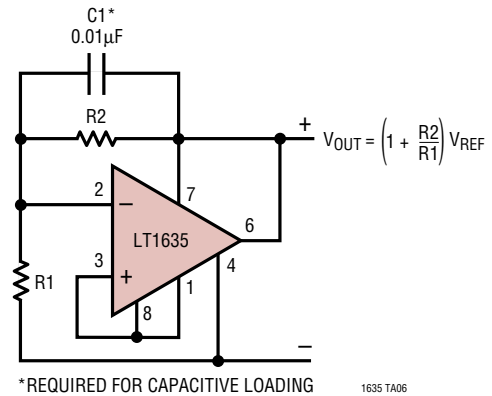

Negative Regulator

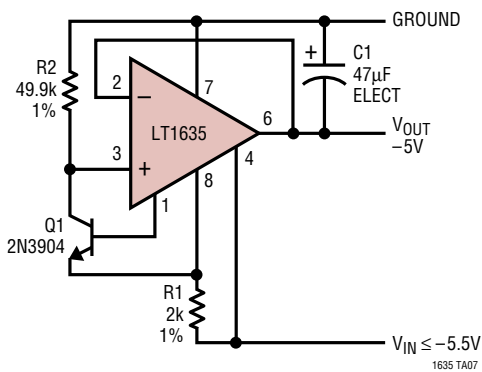

6V Battery-Level Indicator

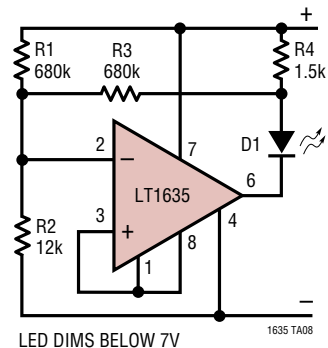

# SIMPLIFIED SCHEMATICS

Op Amp

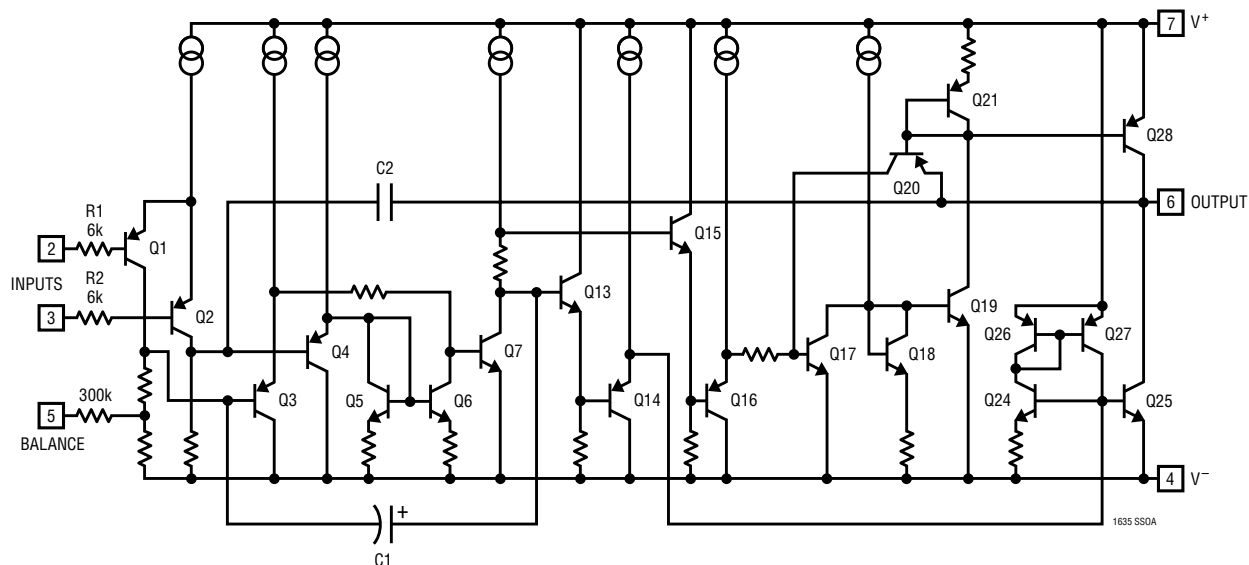

Reference

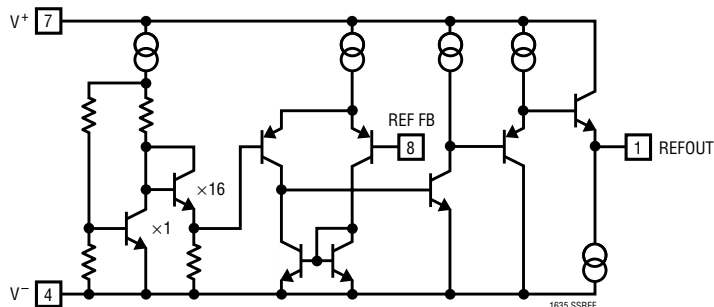

# PACKAGE DESCRIPTION

**N8 Package**  
**8-Lead PDIP (Narrow .300 Inch)**  
 (Reference LTC DWG # 05-08-1510)

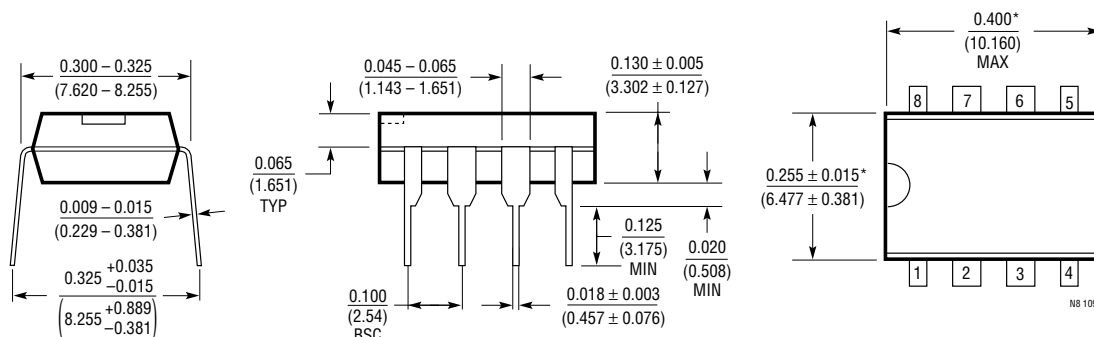

\*THESE DIMENSIONS DO NOT INCLUDE MOLD FLASH OR PROTRUSIONS.  
 MOLD FLASH OR PROTRUSIONS SHALL NOT EXCEED 0.010 INCH (0.254mm)

# TYPICAL APPLICATION

1A Shunt Battery Charger ( $I_{DARK} = 230\mu A$ ,  $V_{FLOAT} = 14V$ )

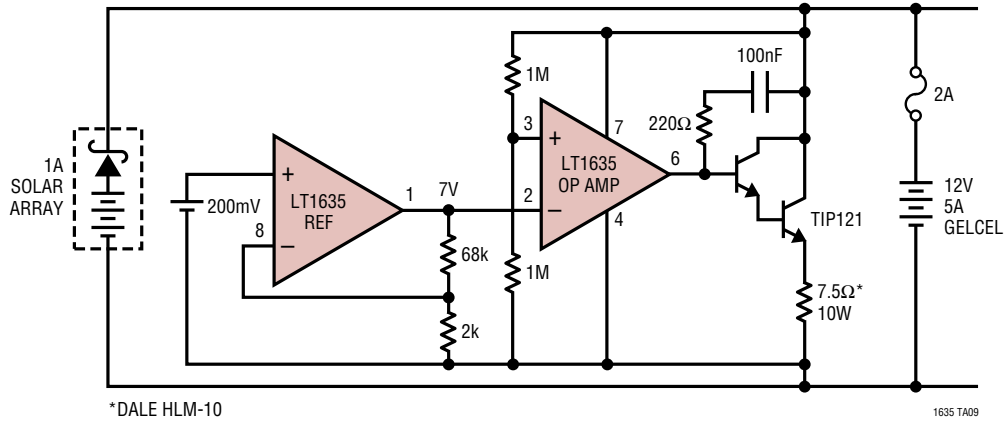

# PACKAGE DESCRIPTION

**S8 Package**  
**8-Lead Plastic Small Outline (Narrow .150 Inch)**  
 (Reference LTC DWG # 05-08-1610)

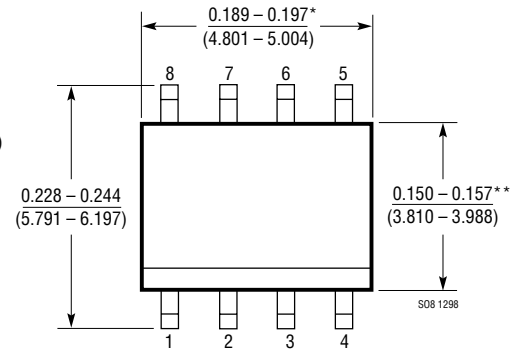
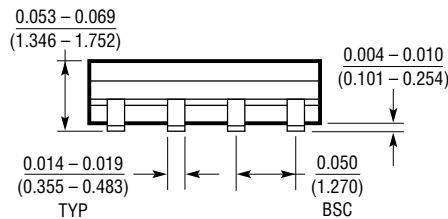
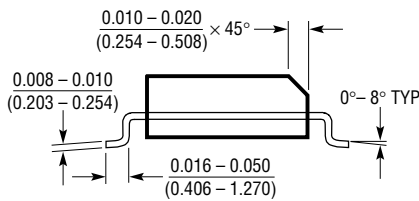

\*DIMENSION DOES NOT INCLUDE MOLD FLASH. MOLD FLASH SHALL NOT EXCEED 0.006" (0.152mm) PER SIDE  
 \*\*DIMENSION DOES NOT INCLUDE INTERLEAD FLASH. INTERLEAD FLASH SHALL NOT EXCEED 0.010" (0.254mm) PER SIDE

# RELATED PARTS

PART NUMBER	DESCRIPTION	COMMENTS
LT1178/LT1179	Dual/Quad 17μA Max, Single Supply Precision Op Amps	70μV $V_{OS}$ Max and 2.5μV/°C Drift Max, 85kHz GBW, 0.04V/μs Slew Rate, Input/Output Common Mode Includes Ground
LT1490A/LT1491A	Dual/Quad Micropower Rail-to-Rail Input and Output Op Amps	Single Supply Input Range: -0.4V to 44V, Micropower 50μA Amplifier, Rail-to-Rail Input and Output, 200kHz GBW
LT2178/LT2179	Dual/Quad 17μA Max, Single Supply Precision Op Amps	SO-8 and 14-Lead Standard Pinout, 70μV $V_{OS}$ Max, 85kHz GBW
LT1078/LT1079	Dual/Quad Micropower, Single Supply Precision Op Amps	70μV $V_{OS}$ Max and 0.4μV/°C Drift, 200kHz GBW, 0.07V/μs Slew Rate, Input/Output Common Mode Includes Ground
LT2078/LT2079	Dual/Quad Micropower, Single Supply Precision Op Amps	SO-8 and 14-Lead Standard Pinout, 70μV $V_{OS}$ Max, 200kHz GBW

## X-ON Electronics

Largest Supplier of Electrical and Electronic Components

*Click to view similar products for [Operational Amplifiers - Op Amps](#) category:*

*Click to view products by [Analog Devices](#) manufacturer:*

Other Similar products are found below :

[NCV33072ADR2G](#) [LM258AYDT](#) [LM358SNG](#) [430227FB](#) [UPC824G2-A](#) [LT1678IS8](#) [042225DB](#) [058184EB](#) [UPC822G2-A](#) [UPC259G2-A](#)  
[UPC258G2-A](#) [NCV33202DMR2G](#) [NTE925](#) [AZV358MTR-G1](#) [AP4310AUMTR-AG1](#) [HA1630D02MMEL-E](#) [HA1630S01LPEL-E](#)  
[SCY33178DR2G](#) [NJU77806F3-TE1](#) [NCV5652MUTWG](#) [NCV20034DR2G](#) [LM324EDR2G](#) [LM2902EDR2G](#) [NTE7155](#) [NTE778S](#) [NTE871](#)  
[NTE924](#) [NTE937](#) [MCP6V17T-E/MNY](#) [MCP6V19-E/ST](#) [MXD8011HF](#) [MCP6V16UT-E/OT](#) [MCP6V17T-E/MS](#) [MCP6V19T-E/ST](#)  
[SCY6358ADR2G](#) [ADA4523-1BCPZ](#) [LTC2065HUD#PBF](#) [ADA4523-1BCPZ-RL7](#) [2SD965T-R](#) [RS6332PXK](#) [BDM8551](#) [BDM321](#) [MD1324](#)  
[COS8052SR](#) [COS8552SR](#) [COS8554SR](#) [COS2177SR](#) [COS2353SR](#) [COS724TR](#) [LM2902M/TR](#)