

Dual 500mA, 200MHz xDSL Line Driver Amplifier

FEATURES

- 3mm × 4mm High Power DFN Package
- Exceeds All Requirements For Full Rate, Downstream ADSL Line Drivers
- ±500mA Minimum I_{OUT}
- ±11.1V Output Swing, $V_S = \pm 12V$, $R_L = 100\Omega$
- ±10.9V Output Swing, $V_S = \pm 12V$, $I_L = 250mA$
- Low Distortion: -82dBc at 1MHz, 2V_{p-p} Into 50Ω
- Power Saving Adjustable Supply Current
- Power Enhanced TSSOP-20 Small Footprint Package
- 200MHz Gain Bandwidth
- 600V/μs Slew Rate
- Specified at ±12V and ±5V

APPLICATIONS

- High Density ADSL Central Office Line Drivers
- High Efficiency ADSL, HDSL2, G.lite, SHDSL Line Drivers
- Buffers
- Test Equipment Amplifiers
- Cable Drivers

DESCRIPTION

The LT[®]1739 is a 500mA minimum output current, dual op amp with outstanding distortion performance. The amplifiers are gain-of-ten stable, but can be easily compensated for lower gains. The extended output swing allows for lower supply rails to reduce system power. Supply current is set with an external resistor to optimize power dissipation. The LT1739 features balanced, high impedance inputs with low input bias current and input offset voltage. Active termination is easily implemented for further system power reduction. Short-circuit protection and thermal shutdown insure the device's ruggedness.

The outputs drive a 100Ω load to ±11.1V with ±12V supplies, and ±10.9V with a 250mA load. The LT1739 is a pin-for-pin replacement for the LT1794 in xDSL line driver applications and requires no circuit changes.

The LT1739 is available in the very small, thermally enhanced, 3mm × 4mm DFN package or a 20-lead TSSOP for maximum port density in central office line driver applications. For a dual version of the LT1739, see the LT6301 data sheet.

 LTC and LT are registered trademarks of Linear Technology Corporation.

TYPICAL APPLICATION

High Efficiency ±12V Supply ADSL Central Office Line Driver

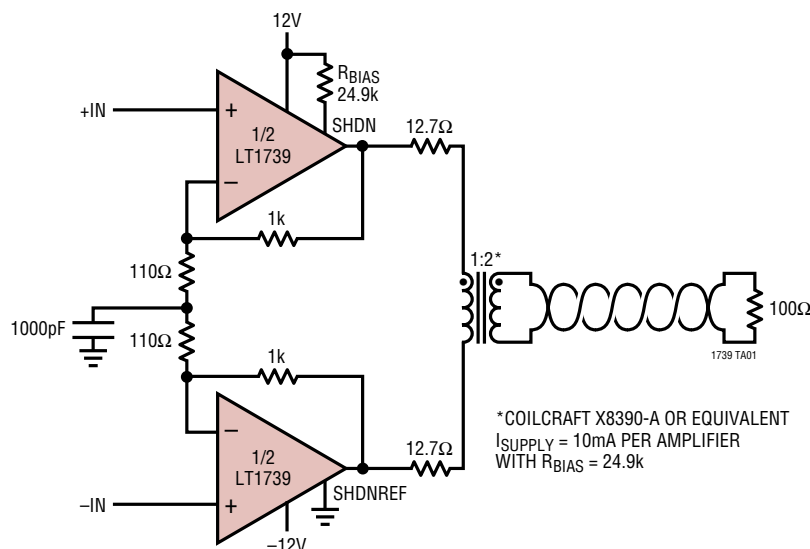

3mm × 4mm DFN Package
Bottom View

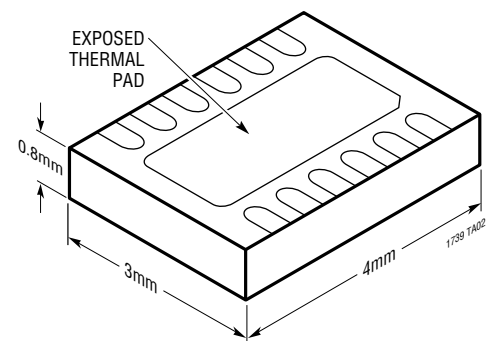

ABSOLUTE MAXIMUM RATINGS (Note 1)

Supply Voltage (V^+ to V^-)	$\pm 13.5V$	Junction Temperature	
Input Current	$\pm 10mA$	FE Package	150°C
Output Short-Circuit Duration (Note 2)	Indefinite	UE Package	125°C
Operating Temperature Range	-40°C to 85°C	Storage Temperature Range	
Specified Temperature Range (Note 3) ..	-40°C to 85°C	FE Package	-65°C to 150°C
		UE Package	-65°C to 125°C
		Lead Temperature (Soldering, 10 sec)	300°C

PACKAGE/ORDER INFORMATION

<p>FE PACKAGE 20-LEAD PLASTIC TSSOP $T_{JMAX} = 150^{\circ}C$, $\theta_{JA} = 40^{\circ}C/W$, $\theta_{JC} = 3^{\circ}C/W$ (Note 4) UNDERSIDE METAL CONNECTED TO V^-</p>	<p>ORDER PART NUMBER</p> <p>LT1739CFE LT1739IFE</p>	<p>UE12 PACKAGE 12-LEAD (4mm x 3mm) PLASTIC DFN $T_{JMAX} = 125^{\circ}C$, $\theta_{JA} = 60^{\circ}C/W$, $\theta_{JC} = 3^{\circ}C/W$ (Note 4) UNDERSIDE METAL CONNECTED TO V^-</p>	<p>ORDER PART NUMBER</p> <p>LT1739CUE LT1739IUE</p>
			<p>UE PART MARKING</p> <p>1739 1739I</p>

Consult LTC Marketing for parts specified with wider operating temperature ranges.

ELECTRICAL CHARACTERISTICS

The ● denotes the specifications which apply over the full specified temperature range, otherwise specifications are at $T_A = 25^{\circ}C$. $V_{CM} = 0V$, pulse tested, $\pm 5V \leq V_S \leq \pm 12V$, $V_{SHDNREF} = 0V$, $R_{BIAS} = 24.9k$ between V^+ and SHDN unless otherwise noted. (Note 3)

SYMBOL	PARAMETER	CONDITIONS	MIN	TYP	MAX	UNITS
V_{OS}	Input Offset Voltage		●	1	5.0	mV
			●		7.5	mV
	Input Offset Voltage Matching		●	0.3	5.0	mV
			●		7.5	mV
	Input Offset Voltage Drift		●	10		$\mu V/^{\circ}C$
I_{OS}	Input Offset Current		●	100	500	nA
			●		800	nA
I_B	Input Bias Current		●	± 0.1	± 4	μA
			●		± 6	μA
	Input Bias Current Matching		●	100	500	nA
			●		800	nA
e_n	Input Noise Voltage Density	$f = 10kHz$		8		nV/\sqrt{Hz}
i_n	Input Noise Current Density	$f = 10kHz$		0.8		pA/\sqrt{Hz}

ELECTRICAL CHARACTERISTICS

The ● denotes the specifications which apply over the full specified temperature range, otherwise specifications are at $T_A = 25^\circ\text{C}$. $V_{CM} = 0\text{V}$, pulse tested, $\pm 5\text{V} \leq V_S \leq \pm 12\text{V}$, $V_{SHDNREF} = 0\text{V}$, $R_{BIAS} = 24.9\text{k}$ between V^+ and SHDN unless otherwise noted. (Note 3)

SYMBOL	PARAMETER	CONDITIONS	MIN	TYP	MAX	UNITS
R_{IN}	Input Resistance	$V_{CM} = (V^+ - 2\text{V})$ to $(V^- + 2\text{V})$ Differential	● 5	50 6.5		$M\Omega$ $M\Omega$
C_{IN}	Input Capacitance			3		μF
	Input Voltage Range (Positive) Input Voltage Range (Negative)	(Note 5) (Note 5)	● $V^+ - 2$ ● $V^- + 1$	$V^+ - 1$ $V^- + 2$	$V^- + 2$	V V
CMRR	Common Mode Rejection Ratio	$V_{CM} = (V^+ - 2\text{V})$ to $(V^- + 2\text{V})$	● 74 ● 66	83		dB dB
PSRR	Power Supply Rejection Ratio	$V_S = \pm 4\text{V}$ to $\pm 12\text{V}$	● 74 ● 66	88		dB dB
A_{VOL}	Large-Signal Voltage Gain (Note 8)	$V_S = \pm 12\text{V}$, $V_{OUT} = \pm 10\text{V}$, $R_L = 40\Omega$ $V_S = \pm 5\text{V}$, $V_{OUT} = \pm 3\text{V}$, $R_L = 25\Omega$	● 63 ● 57	76		dB dB
V_{OUT}	Output Swing (Note 8)	$V_S = \pm 12\text{V}$, $R_L = 100\Omega$ $V_S = \pm 12\text{V}$, $I_L = 250\text{mA}$ $V_S = \pm 5\text{V}$, $R_L = 25\Omega$ $V_S = \pm 5\text{V}$, $I_L = 250\text{mA}$	● 10.9 ● 10.7 ● 10.6 ● 10.4 ● 3.7 ● 3.5 ● 3.6 ● 3.4	11.1 10.9		$\pm\text{V}$ $\pm\text{V}$ $\pm\text{V}$ $\pm\text{V}$ $\pm\text{V}$ $\pm\text{V}$ $\pm\text{V}$ $\pm\text{V}$
I_{OUT}	Maximum Output Current (Note 8)	$V_S = \pm 12\text{V}$, $R_L = 1\Omega$		500	1200	mA
I_S	Supply Current per Amplifier	$V_S = \pm 12\text{V}$, $R_{BIAS} = 24.9\text{k}$ (Note 6) $V_S = \pm 12\text{V}$, $R_{BIAS} = 32.4\text{k}$ (Note 6) $V_S = \pm 12\text{V}$, $R_{BIAS} = 43.2\text{k}$ (Note 6) $V_S = \pm 12\text{V}$, $R_{BIAS} = 66.5\text{k}$ (Note 6) $V_S = \pm 5\text{V}$, $R_{BIAS} = 24.9\text{k}$ (Note 6)	● 8.0 ● 6.7 ● 2.2 ● 1.8	10 8 6 4 3.4	13.5 15.0 5.0 5.8	mA mA mA mA mA mA
	Supply Current in Shutdown	$V_{SHDN} = 0.4\text{V}$		0.1	1	mA
	Output Leakage in Shutdown	$V_{SHDN} = 0.4\text{V}$		0.3	1	mA
	Channel Separation (Note 8)	$V_S = \pm 12\text{V}$, $V_{OUT} = \pm 10\text{V}$, $R_L = 40\Omega$	● 80 ● 77	110		dB dB
SR	Slew Rate	$V_S = \pm 12\text{V}$, $A_V = -10$, (Note 7) $V_S = \pm 5\text{V}$, $A_V = -10$, (Note 7)		300 100	600 200	$\text{V}/\mu\text{s}$ $\text{V}/\mu\text{s}$
HD2	Differential 2nd Harmonic Distortion	$V_S = \pm 12\text{V}$, $A_V = 10$, $2V_{P-P}$, $R_L = 50\Omega$, 1MHz		-85		dBc
HD3	Differential 3rd Harmonic Distortion	$V_S = \pm 12\text{V}$, $A_V = 10$, $2V_{P-P}$, $R_L = 50\Omega$, 1MHz		-82		dBc
GBW	Gain Bandwidth	$f = 1\text{MHz}$		200		MHz

Note 1: Absolute Maximum Ratings are those values beyond which the life of a device may be impaired.

Note 2: Applies to short circuits to ground only. A short circuit between the output and either supply may permanently damage the part when operated on supplies greater than $\pm 10\text{V}$.

Note 3: The LT1739C is guaranteed to meet specified performance from 0°C to 85°C and is designed, characterized and expected to meet these extended temperature limits, but is not tested at -40°C . The LT1739I is guaranteed to meet the extended temperature limits.

Note 4: Thermal resistance varies depending upon the amount of PC board metal attached to the device and rate of air flow over the device. If the

maximum dissipation of the package is exceeded, the device will go into thermal shutdown and be protected.

Note 5: Guaranteed by the CMRR tests.

Note 6: R_{BIAS} is connected between V^+ and the SHDN pin, with the SHDNREF pin grounded.

Note 7: Slew rate is measured at $\pm 5\text{V}$ on a $\pm 10\text{V}$ output signal while operating on $\pm 12\text{V}$ supplies and $\pm 1\text{V}$ on a $\pm 3\text{V}$ output signal while operating on $\pm 5\text{V}$ supplies.

Note 8: This parameter of the LT1739CUE/LT1739IUE is 100% tested at room temperature, but is not tested at -40°C , 0°C or 85°C .

TYPICAL PERFORMANCE CHARACTERISTICS

Supply Current vs Ambient Temperature

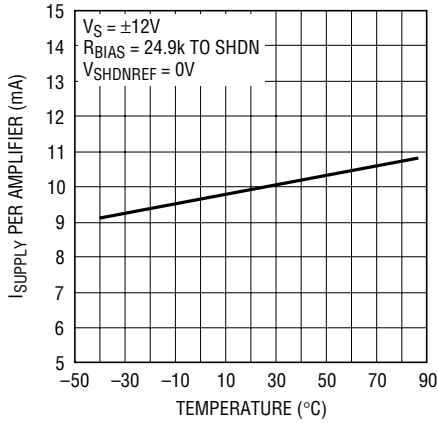

1739 G01

Input Common Mode Range vs Supply Voltage

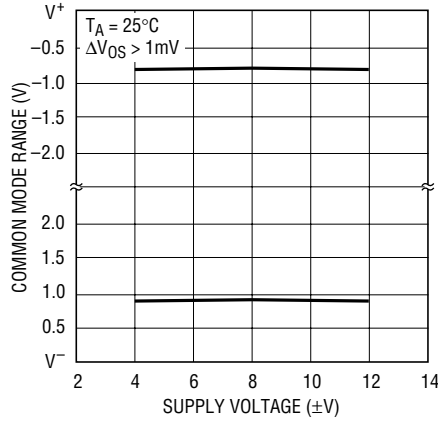

1739 G02

Input Bias Current vs Ambient Temperature

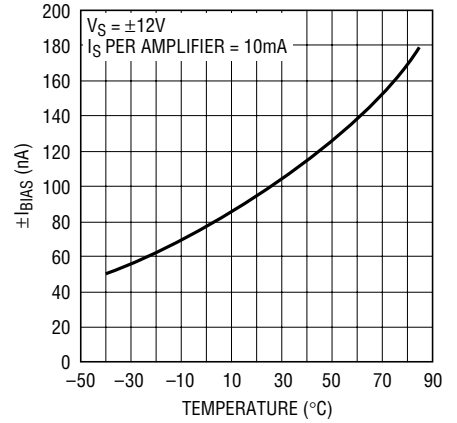

1739 G03

Input Noise Spectral Density

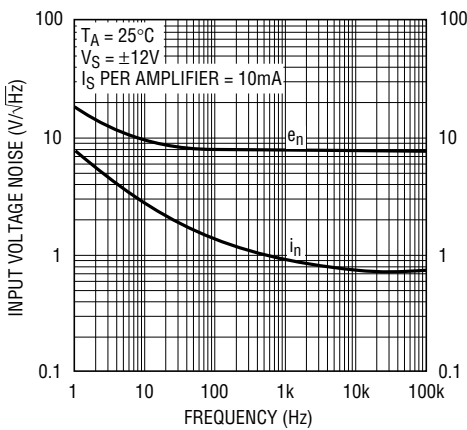

1739 G04

Output Short-Circuit Current vs Ambient Temperature

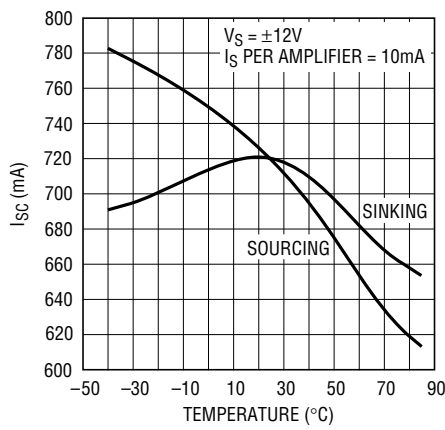

1739 G05

Output Saturation Voltage vs Ambient Temperature

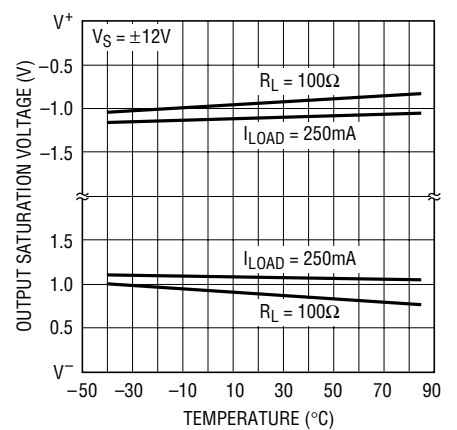

1739 G06

Open-Loop Gain and Phase vs Frequency

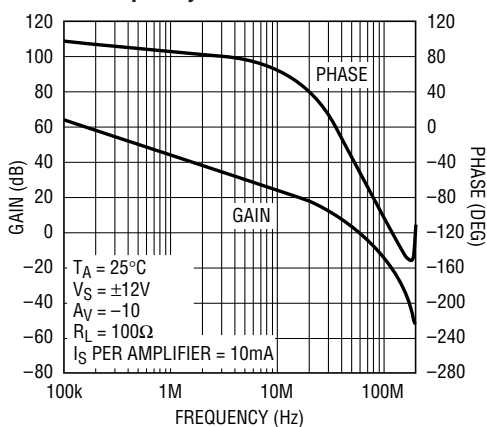

1739 G07

-3dB Bandwidth vs Supply Current

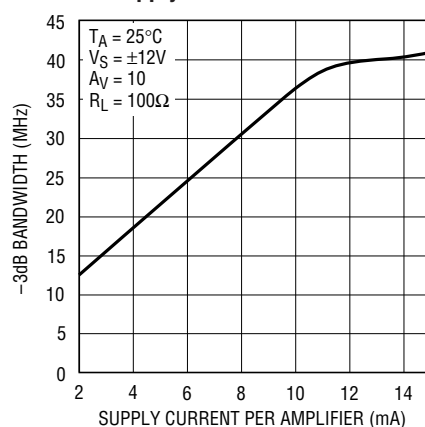

1739 G08

Slew Rate vs Supply Current

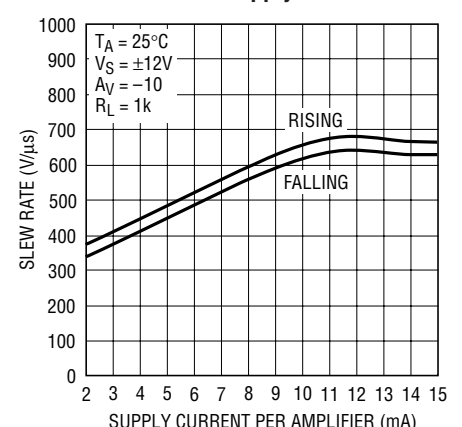

1739 G09

TYPICAL PERFORMANCE CHARACTERISTICS

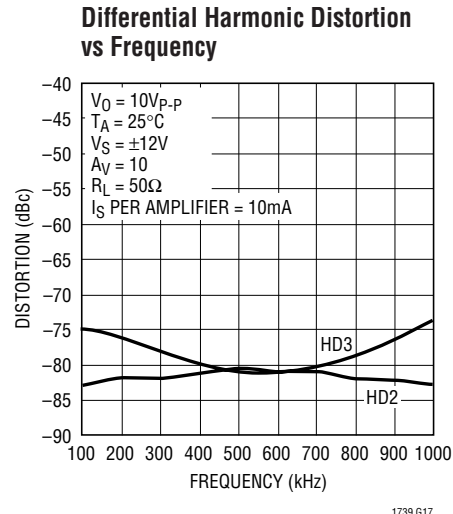
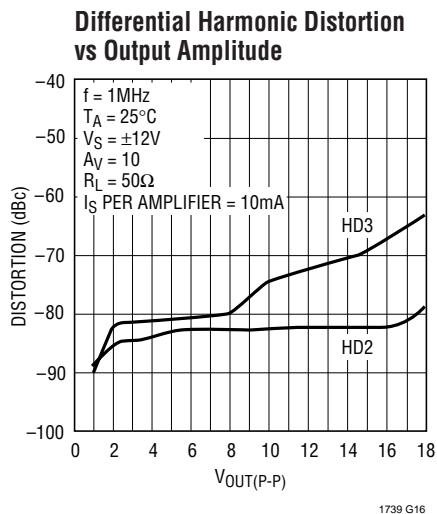
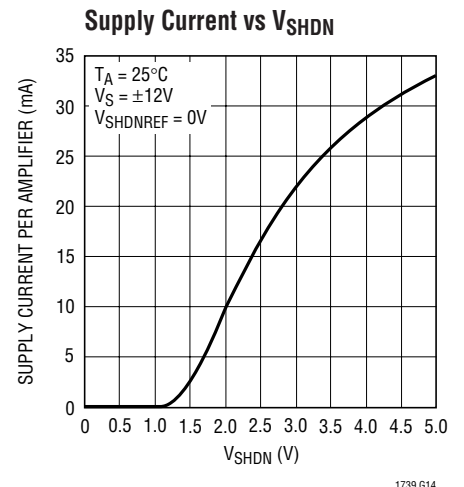
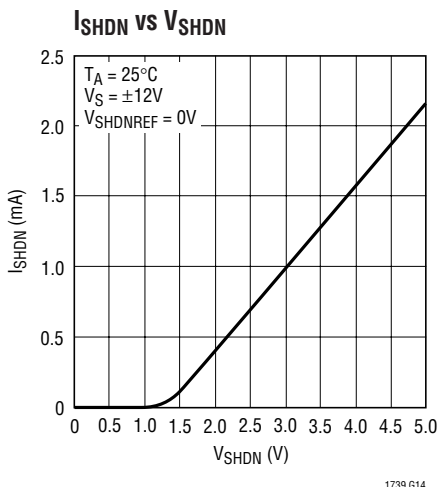
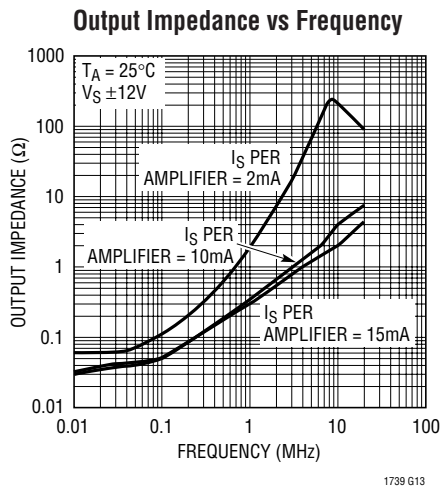
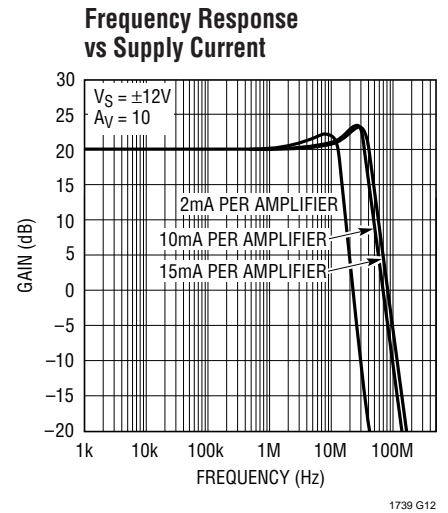
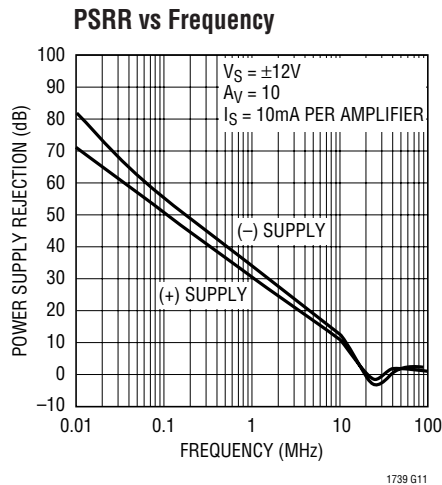
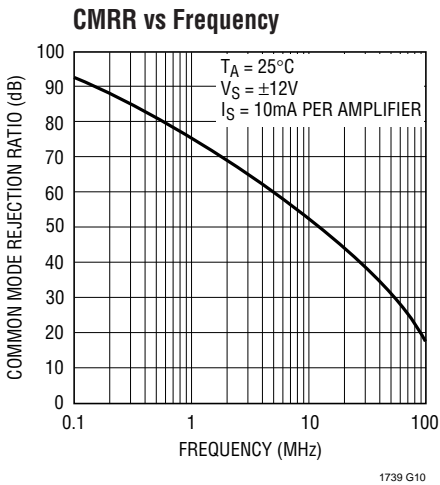

TYPICAL PERFORMANCE CHARACTERISTICS

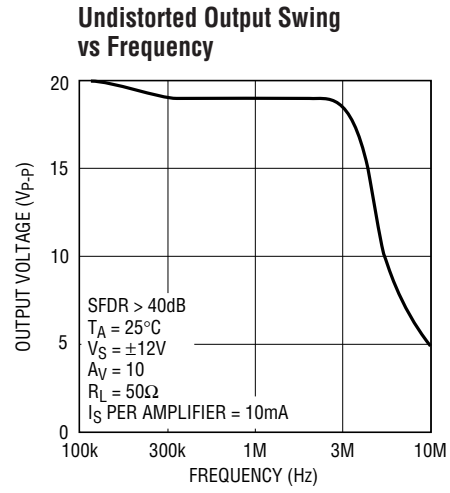
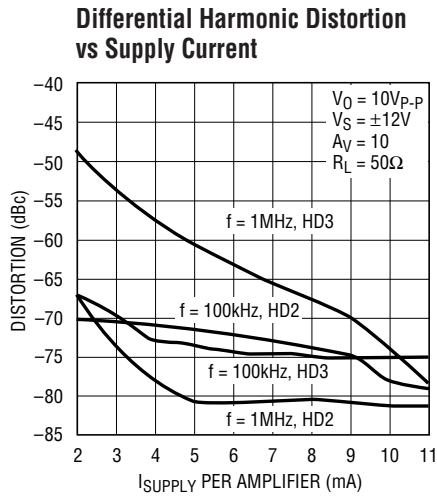

TEST CIRCUIT

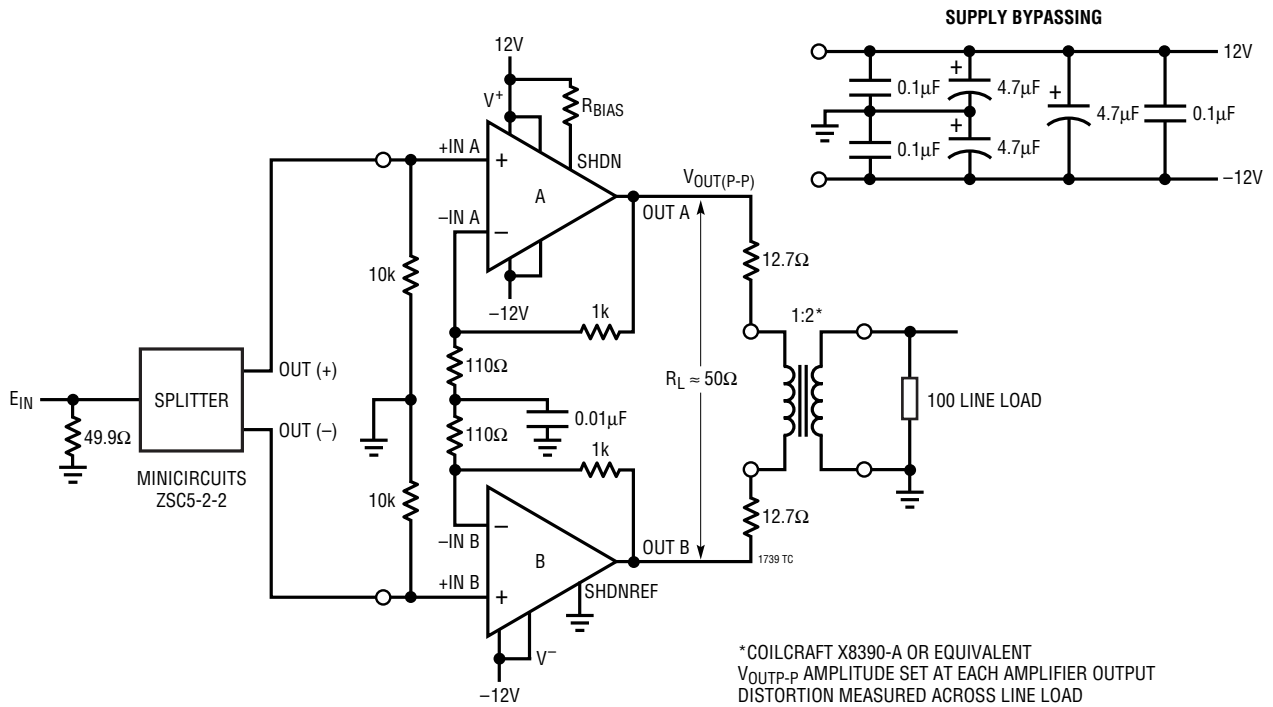

APPLICATIONS INFORMATION

The LT1739 is a high speed, 200MHz gain bandwidth product, dual voltage feedback amplifier with high output current drive capability, 500mA source and sink. The LT1739 is ideal for use as a line driver in xDSL data communication applications. The output voltage swing has been optimized to provide sufficient headroom when operating from $\pm 12V$ power supplies in full-rate ADSL applications. The LT1739 also allows for an adjustment of the operating current to minimize power consumption. In addition, the LT1739 is available in small footprint $3mm \times 4mm$ DFN and 20-lead TSSOP surface mount package to minimize PCB area in multiport central office DSL cards.

To minimize signal distortion, the LT1739 amplifiers are decompensated to provide very high open-loop gain at high frequency. As a result each amplifier is frequency stable with a closed-loop gain of 10 or more. If a closed-loop gain of less than 10 is desired, external frequency compensating components can be used.

Setting the Quiescent Operating Current

Power consumption and dissipation are critical concerns in multiport xDSL applications. Two pins, Shutdown (SHDN) and Shutdown Reference (SHDNREF), are provided to control quiescent power consumption and allow for the complete shutdown of the driver. The quiescent current should be set high enough to prevent distortion induced errors in a particular application, but not so high that power is wasted in the driver unnecessarily. A good starting point to evaluate the LT1739 is to set the quiescent current to 10mA per amplifier.

The internal biasing circuitry is shown in Figure 1. Grounding the SHDNREF pin and directly driving the SHDN pin with a voltage can control the operating current as seen in the Typical Performance Characteristics. When the SHDN pin is less than SHDNREF + 0.4V, the driver is shut down and consumes typically only 100 μA of supply current and the outputs are in a high impedance state. Part to part variations, however, will cause inconsistent control of the quiescent current if direct voltage drive of the SHDN pin is used.

Using a single external resistor, R_{BIAS} , connected in one of two ways provides a much more predictable control of the quiescent supply current. Figure 2 illustrates the effect

on supply current per amplifier with R_{BIAS} connected between the SHDN pin and the 12V V^+ supply of the LT1739 and the approximate design equations. Figure 3 illustrates the same control with R_{BIAS} connected between the SHDNREF pin and ground while the SHDN pin is tied to V^+ . Either approach is equally effective.

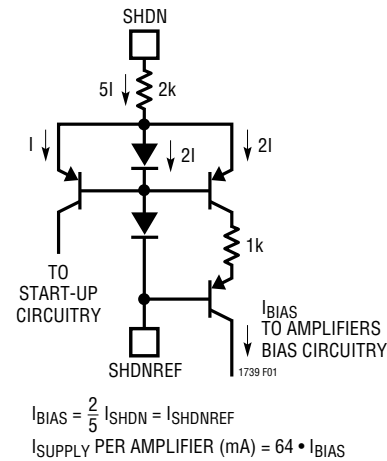

Figure 1. Internal Current Biasing Circuitry

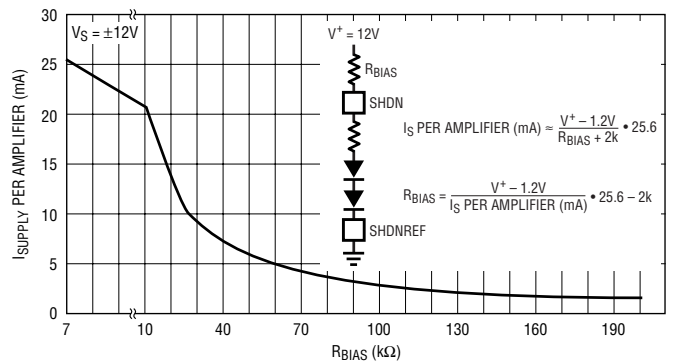

Figure 2. R_{BIAS} to V^+ Current Control

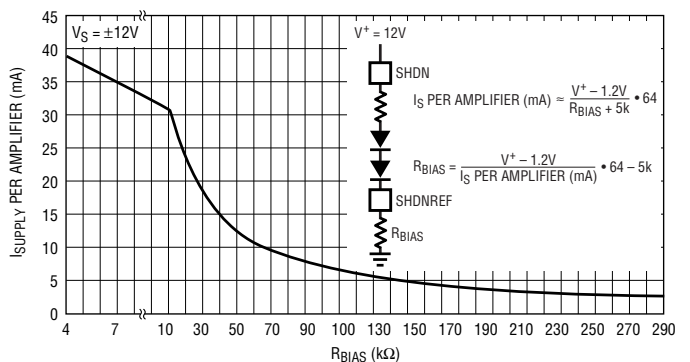

Figure 3. R_{BIAS} to Ground Current Control

APPLICATIONS INFORMATION

Logic Controlled Operating Current

The DSP controller in a typical xDSL application can have I/O pins assigned to provide logic control of the LT1739 line driver operating current. As shown in Figure 4 one or two logic control inputs can set two or four different operating modes. The logic inputs add or subtract current to the SHDN input to set the operating current. The one logic input example selects the supply current to be either full power, 10mA per amplifier or just 2mA per amplifier, which significantly reduces the driver power consumption while maintaining less than 2Ω output impedance to frequencies less than 1MHz. This low power mode retains termination impedance at the amplifier outputs and the line driving back termination resistors. With this termination, while a DSL port is not transmitting data, it can still sense a received signal from the line across the back-termination resistors and respond accordingly.

The two logic input control provides two intermediate (approximately 7mA per amplifier and 5mA per amplifier) operating levels between full power and termination modes. For proper operation of the current control circuitry, it is necessary that the SHDNREF pin be biased at least 2V more positive than V⁻. In single supply applications where V⁻ is at ground potential, special attention to the DC bias of the SHDNREF pin is required. Contact

Linear Technology for assistance in implementing a single supply design with operating current control. These modes can be useful for overall system power management when full power transmissions are not necessary.

Shutdown and Recovery

The ultimate power saving action on a completely idle port is to fully shut down the line driver by pulling the SHDN pin to within 0.4V of the SHDNREF potential. As shown in Figure 5 complete shutdown occurs in less than 10μs and, more importantly, complete recovery from the shut down state to full operation occurs in less than 2μs. The biasing circuitry in the LT1739 reacts very quickly to bring the amplifiers back to normal operation.

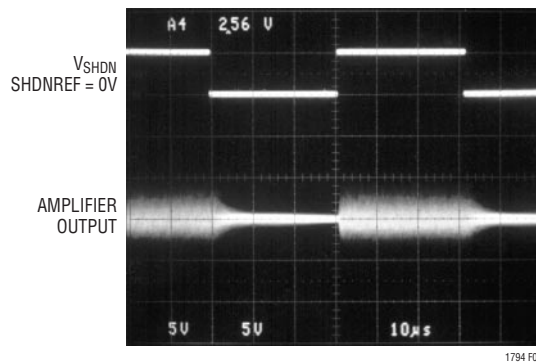
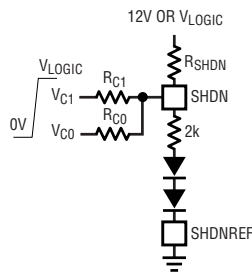

Figure 5. Shutdown and Recovery Timing

Two Control Inputs

		RESISTOR VALUES (kΩ)					
		R _{SHDN TO V_{CC}} (12V)			R _{SHDN TO V_{LOGIC}}		
V _{LOGIC}	R _{SHDN}	3V	3.3V	5V	3V	3.3V	5V
	R _{C1}	11.5	13.0	21.5	8.66	10.7	20.5
	R _{C0}	19.1	22.1	36.5	14.3	17.8	34.0
V _{C1}	V _{C0}	SUPPLY CURRENT PER AMPLIFIER (mA)					
H	H	10	10	10	10	10	10
H	L	7	7	7	7	7	7
L	H	5	5	5	5	5	5
L	L	2	2	2	2	2	2



One Control Input

		RESISTOR VALUES (kΩ)					
		R _{SHDN TO V_{CC}} (12V)			R _{SHDN TO V_{LOGIC}}		
V _{LOGIC}	R _{SHDN}	3V	3.3V	5V	3V	3.3V	5V
	R _C	7.32	8.25	13.7	5.49	6.65	12.7
V _C	SUPPLY CURRENT PER AMPLIFIER (mA)						
H	10	10	10	10	10	10	10
L	2	2	2	2	2	2	2

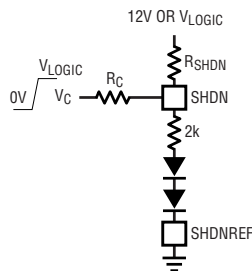

Figure 4. Providing Logic Input Control of Operating Current

Power Dissipation and Heat Management

xDSL applications require the line driver to dissipate a significant amount of power and heat compared to other components in the system. The large peak to RMS variations of DMT and CAP ADSL signals require high supply voltages to prevent clipping, and the use of a step-up transformer to couple the signal to the telephone line can require high peak current levels. These requirements result in the driver package having to dissipate significant amounts of power. Several multiport cards inserted into a rack in an enclosed central office box can add up to many, many watts of power dissipation in an elevated ambient temperature environment. The LT1739 has built-in thermal shutdown circuitry that will protect the amplifiers if operated at excessive temperatures, however data transmissions will be seriously impaired. It is important in

APPLICATIONS INFORMATION

the design of the PCB and card enclosure to take measures to spread the heat developed in the driver away to the ambient environment to prevent thermal shutdown (which occurs when the junction temperature of the LT1739 exceeds 165°C).

Estimating Line Driver Power Dissipation

Figure 6 is a typical ADSL application shown for the purpose of estimating the power dissipation in the line driver. Due to the complex nature of the DMT signal, which looks very much like noise, it is easiest to use the RMS values of voltages and currents for estimating the driver power dissipation. The voltage and current levels shown for this example are for a full-rate ADSL signal driving 20dBm or 100mW_{RMS} of power on to the 100Ω telephone line and assuming a 0.5dBm insertion loss in the transformer. The quiescent current for the LT1739 is set to 10mA per amplifier.

The power dissipated in the LT1739 is a combination of the quiescent power and the output stage power when driving a signal. The two amplifiers are configured to place a differential signal on to the line. The Class AB output stage in each amplifier will simultaneously dissipate power in

the upper power transistor of one amplifier, while sourcing current, and the lower power transistor of the other amplifier, while sinking current. The total device power dissipation is then:

$$P_D = P_{\text{QUIESCENT}} + P_{\text{Q(UPPER)}} + P_{\text{Q(LOWER)}}$$

$$P_D = (V^+ - V^-) \cdot I_Q + (V^+ - V_{\text{OUT(ARMS)}}) \cdot I_{\text{LOAD}} + (V^- - V_{\text{OUT(BRMS)}}) \cdot I_{\text{LOAD}}$$

With no signal being placed on the line and the amplifier biased for 10mA per amplifier supply current, the quiescent driver power dissipation is:

$$P_{\text{DQ}} = 24\text{V} \cdot 20\text{mA} = 480\text{mW}$$

This can be reduced in many applications by operating with a lower quiescent current value.

When driving a load, a large percentage of the amplifier quiescent current is diverted to the output stage and becomes part of the load current. Figure 7 illustrates the total amount of biasing current flowing between the + and - power supplies through the amplifiers as a function of load current. As much as 60% of the quiescent no load operating current is diverted to the load.

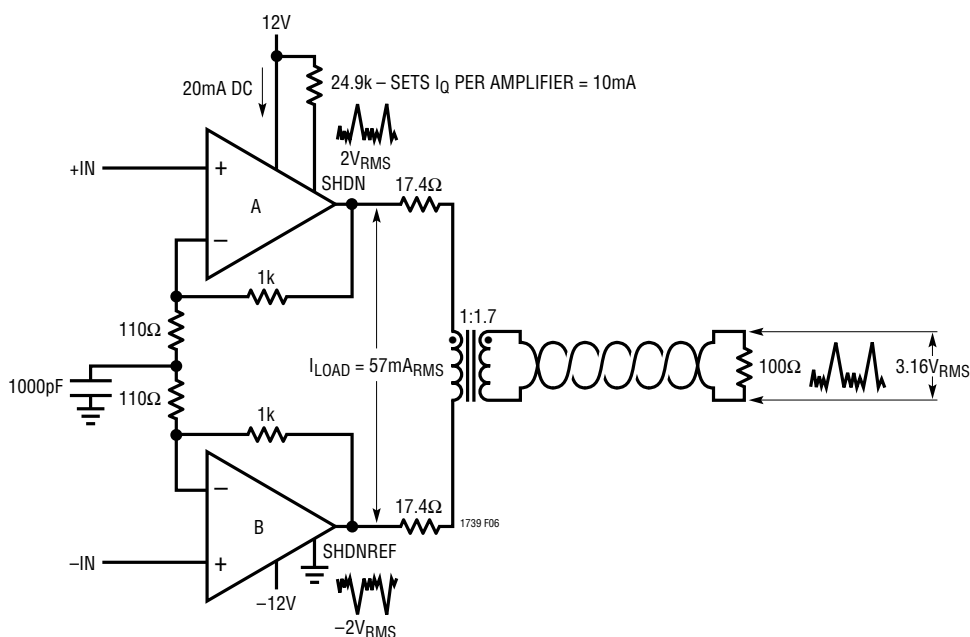

Figure 6. Estimating Line Driver Power Dissipation

APPLICATIONS INFORMATION

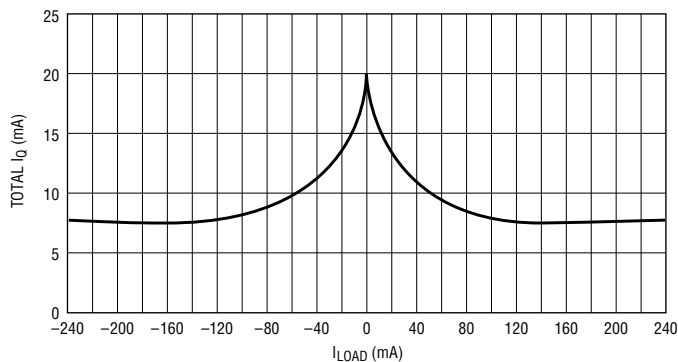

Figure 7. I_Q vs I_{LOAD}

At full power to the line the driver power dissipation is:

$$P_{D(FULL)} = 24V \cdot 8mA + (12V - 2V_{RMS}) \cdot 57mA_{RMS} + [|-12V - (-2V_{RMS})|] \cdot 57mA_{RMS}$$

$$P_{D(FULL)} = 192mW + 570mW + 570mW = 1.332W^*$$

The junction temperature of the driver must be kept less than the thermal shutdown temperature when processing a signal. The junction temperature is determined from the following expression:

$$T_J = T_{AMBIENT} (^\circ C) + P_{D(FULL)} (W) \cdot \theta_{JA} (^\circ C/W)$$

θ_{JA} is the thermal resistance from the junction of the LT1739 to the ambient air, which can be minimized by heat-spreading PCB metal and airflow through the enclosure as required. For the example given, assuming a maximum ambient temperature of 85°C and keeping the junction temperature of the LT1739 to 140°C maximum, the maximum thermal resistance from junction to ambient required is:

$$\theta_{JA(MAX)} = \frac{140^\circ C - 85^\circ C}{1.332W} = 41.3^\circ C/W$$

Heat Sinking Using PCB Metal

Designing a thermal management system is often a trial and error process as it is never certain how effective it is until it is manufactured and evaluated. As a general rule, the more copper area of a PCB used for spreading heat away from the driver package, the more the operating junction temperature of the driver will be reduced. The limit to this approach however is the need for very

compact circuit layout to allow more ports to be implemented on any given size PCB.

Fortunately xDSL circuit boards use multiple layers of metal for interconnection of components. Areas of metal beneath the LT1739 connected together through several small 13 mil vias can be effective in conducting heat away from the driver package. The use of inner layer metal can free up top and bottom layer PCB area for external component placement.

Figure 8 shows examples of PCB metal being used for heat spreading. These are provided as a reference for what might be expected when using different combinations of metal area on different layers of a PCB. These examples are with a 4-layer board using 1oz copper on each. The most effective layers for spreading heat are those closest to the LT1739 junction. The small TSSOP and DFN packages are very effective for compact line driver designs. Both packages also have an exposed metal heat sinking pad on the bottom side which, when soldered to the PCB top layer metal, directly conducts heat away from the IC junction. Soldering the thermal pad to the board produces a thermal resistance from junction to case, θ_{JC} , of approximately 3°C/W.

As a minimum, the area directly beneath the package on all PCB layers can be used for heat spreading. Limiting the area of metal to just that of the exposed metal heat sinking pad however is not very effective, particularly if the amplifiers are required to dissipate significant power levels. This is shown in Figure 8 for both the TSSOP and DFN packages. Expanding the area of metal on various layers significantly reduces the overall thermal resistance. If possible, an entire unbroken plane of metal close to the heat sinking pad is best for multiple drivers on one PCB card. The addition of vias (small 13mil or smaller holes which fill during PCB plating) connecting all layers of heat spreading metal also helps to reduce operating temperatures of the driver. These too are shown in Figure 8.

















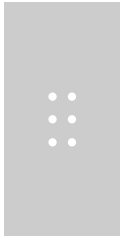

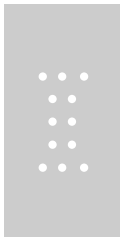

Important Note: The metal planes used for heat sinking the LT1739 are electrically connected to the negative supply potential of the driver, typically -12V. These planes must be isolated from any other power planes used in the board design.

*Note: Design techniques exist to significantly reduce this value. (See Line Driving Back Termination)

APPLICATIONS INFORMATION

When PCB cards containing multiple ports are inserted into a rack in an enclosed cabinet, it is often necessary to provide airflow through the cabinet and over the cards. As

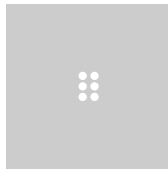
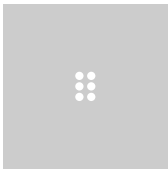
seen in the graph of Figure 8, this is also very effective in further reducing the junction-to-ambient thermal resistance of each line driver.

STILL AIR θ_{JA}	PACKAGE	TOP LAYER	2ND LAYER	3RD LAYER	BOTTOM LAYER
TSSOP 100°C/W					
TSSOP 50°C/W					
TSSOP 45°C/W					
DFN 130°C/W					
DFN 75°C/W					

1739 F08a

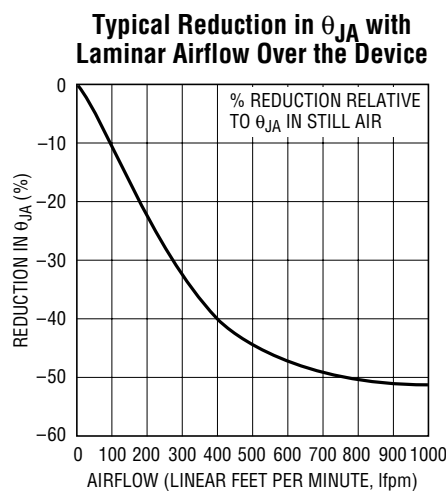

1739 F08b

Figure 8. Examples of PCB Metal Used for Heat Dissipation. Driver Package Mounted on Top Layer. Heat Sink Pad Soldered to Top Layer Metal. Metal Areas Drawn to Scale of Package Size

1739fas, sn1739

APPLICATIONS INFORMATION

Layout and Passive Components

With a gain bandwidth product of 200MHz the LT1739 requires attention to detail in order to extract maximum performance. Use a ground plane, short lead lengths and a combination of RF-quality supply bypass capacitors (i.e., 0.1µF). As the primary applications have high drive current, use low ESR supply bypass capacitors (1µF to 10µF).

The parallel combination of the feedback resistor and gain setting resistor on the inverting input can combine with the input capacitance to form a pole that can cause frequency peaking. In general, use feedback resistors of 1k or less.

Compensation

The LT1739 is stable in a gain 10 or higher for any supply and resistive load. It is easily compensated for lower gains with a single resistor or a resistor plus a capacitor. Figure 9 shows that for inverting gains, a resistor from the inverting node to AC ground guarantees stability if the

parallel combination of R_C and R_G is less than or equal to $R_F/9$. For lowest distortion and DC output offset, a series capacitor, C_C , can be used to reduce the noise gain at lower frequencies. The break frequency produced by R_C and C_C should be less than 5MHz to minimize peaking.

Figure 10 shows compensation in the noninverting configuration. The R_C, C_C network acts similarly to the inverting case. The input impedance is not reduced because the network is bootstrapped. This network can also be placed between the inverting input and an AC ground.

Another compensation scheme for noninverting circuits is shown in Figure 11. The circuit is unity gain at low frequency and a gain of $1 + R_F/R_G$ at high frequency. The DC output offset is reduced by a factor of ten. The techniques of Figures 10 and 11 can be combined as shown in Figure 12. The gain is unity at low frequencies, $1 + R_F/R_G$ at mid-band and for stability, a gain of 10 or greater at high frequencies.

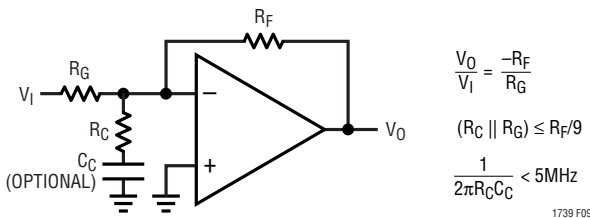

Figure 9. Compensation for Inverting Gains

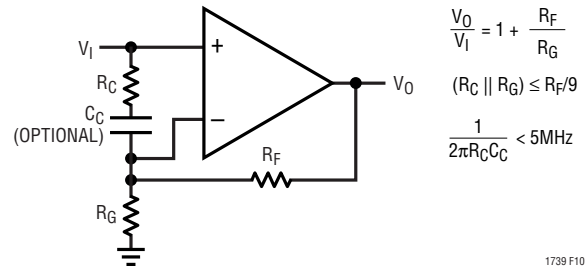

Figure 10. Compensation for Noninverting Gains

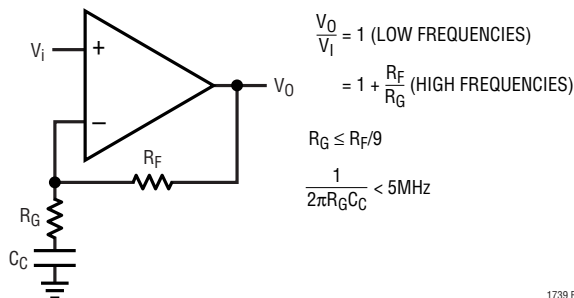

Figure 11. Alternate Noninverting Compensation

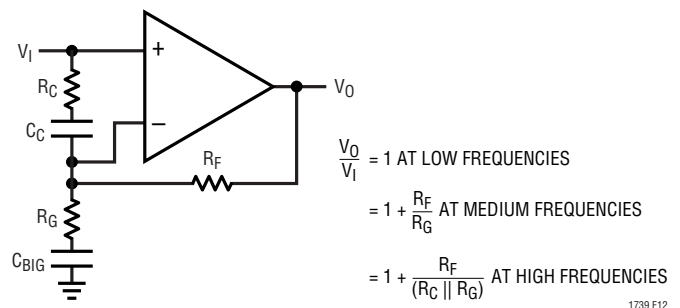

Figure 12. Combination Compensation

APPLICATIONS INFORMATION

In differential driver applications, as shown on the first page of this data sheet, it is recommended that the gain setting resistor be comprised of two equal value resistors connected to a good AC ground at high frequencies. This ensures that the feedback factor of each amplifier remains less than 0.1 at any frequency. The midpoint of the resistors can be directly connected to ground, with the resulting DC gain to the V_{OS} of the amplifiers, or just bypassed to ground with a 1000pF or larger capacitor.

Line Driving Back-Termination

The standard method of cable or line back-termination is shown in Figure 13. The cable/line is terminated in its characteristic impedance (50Ω , 75Ω , 100Ω , 135Ω , etc.). A back-termination resistor also equal to the characteristic impedance should be used for maximum pulse fidelity of outgoing signals, and to terminate the line for incoming signals in a full-duplex application. There are three main drawbacks to this approach. First, the power dissipated in the load and back-termination resistors is equal so half of the power delivered by the amplifier is wasted in the termination resistor. Second, the signal is halved so the gain of the amplifier must be doubled to have the same overall gain to the load. The increase in gain increases noise and decreases bandwidth (which can also increase distortion). Third, the output swing of the amplifier is doubled which can limit the power it can deliver to the load for a given power supply voltage.

An alternate method of back-termination is shown in Figure 14. Positive feedback increases the effective back-termination resistance so R_{BT} can be reduced by a factor of n . To analyze this circuit, first ground the input. As $R_{BT} = R_L/n$, and assuming $R_{P2} \gg R_L$ we require that:

$$\Delta V_A = \Delta V_O (1 - 1/n) \text{ to increase the effective value of } R_{BT} \text{ by } n.$$

$$\Delta V_P = \Delta V_O (1 - 1/n)/(1 + R_F/R_G)$$

$$\Delta V_O = \Delta V_P (1 + R_{P2}/R_{P1})$$

Eliminating ΔV_P , we get the following:

$$(1 + R_{P2}/R_{P1}) = (1 + R_F/R_G)/(1 - 1/n)$$

For example, reducing R_{BT} by a factor of $n = 4$, and with an amplifier gain of $(1 + R_F/R_G) = 10$ requires that $R_{P2}/R_{P1} = 12.3$.

Note that the overall gain is increased:

$$\frac{V_O}{V_I} = \frac{R_{P2}/(R_{P2} + R_{P1})}{\left[(1 + 1/n)/(1 + R_F/R_G) \right] - \left[R_{P1}/(R_{P2} + R_{P1}) \right]}$$

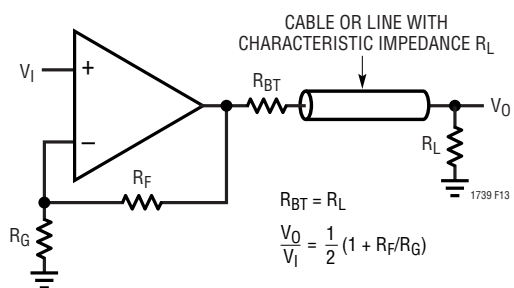

Figure 13. Standard Cable/Line Back Termination

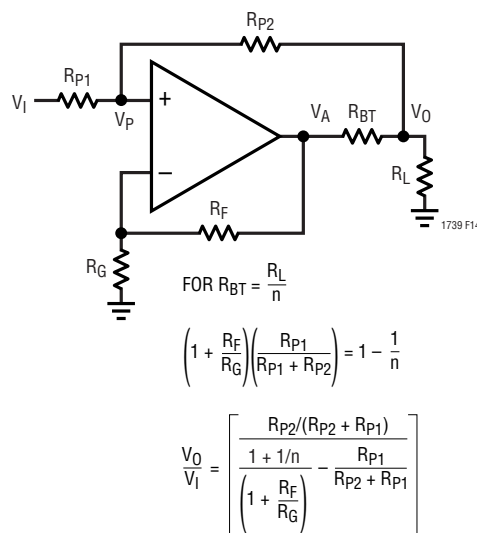

Figure 14. Back Termination Using Postive Feedback

APPLICATIONS INFORMATION

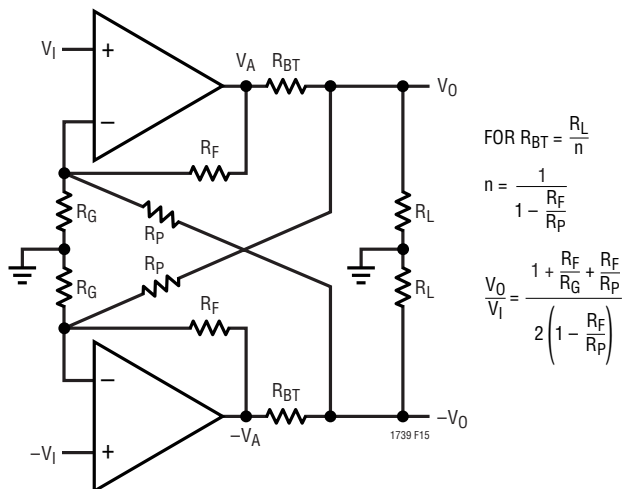

Figure 15. Back Termination Using Differential Positive Feedback

A simpler method of using positive feedback to reduce the back-termination is shown in Figure 15. In this case, the drivers are driven differentially and provide complementary outputs. Grounding the inputs, we see there is inverting gain of $-R_F/R_P$ from $-V_O$ to V_A

$$\Delta V_A = \Delta V_O (R_F/R_P)$$

and assuming $R_P \gg R_L$, we require

$$\Delta V_A = \Delta V_O (1 - 1/n)$$

solving

$$R_F/R_P = 1 - 1/n$$

So to reduce the back-termination by a factor of 3 choose $R_F/R_P = 2/3$. Note that the overall gain is increased to:

$$V_O/V_I = (1 + R_F/R_G + R_F/R_P) / [2(1 - R_F/R_P)]$$

Using positive feedback is often referred to as active termination.

Figure 18 shows a full-rate ADSL line driver incorporating positive feedback to reduce the power lost in the back termination resistors by 40% yet still maintains the proper impedance match to the 100Ω characteristic line impedance. This circuit also reduces the transformer turns ratio

over the standard line driving approach resulting in lower peak current requirements. With lower current and less power loss in the back termination resistors, this driver dissipates only 1W of power, a 30% reduction. (Additional power savings are possible by further reducing the termination resistors' value).

While the power savings of positive feedback are attractive there is one important system consideration to be addressed, received signal sensitivity. The signal received from the line is sensed across the back termination resistors. With positive feedback, signals are present on both ends of the R_{BT} resistors, reducing the sensed amplitude. Extra gain may be required in the receive channel to compensate, or a completely separate receive path may be implemented through a separate line coupling transformer.

A demo board, DC306A-C, is available for the LT1739CFE. This demo board is a complete line driver with an LT1361 receiver included. It allows the evaluation of both standard and active termination approaches. It also has circuitry built in to evaluate the effects of operating with reduced supply current. The schematic of this demo board is shown in Figure 17.

Considerations for Fault Protection

The basic line driver design, shown on the front page of this data sheet, presents a direct DC path between the outputs of the two amplifiers. An imbalance in the DC biasing potentials at the noninverting inputs through either a fault condition or during turn-on of the system can create a DC voltage differential between the two amplifier outputs. This condition can force a considerable amount of current to flow as it is limited only by the small valued back-termination resistors and the DC resistance of the transformer primary. This high current can possibly cause the power supply voltage source to drop significantly impacting overall system performance. If left unchecked, the high DC current can heat the LT1739 to thermal shutdown.

APPLICATIONS INFORMATION

Using DC blocking capacitors, as shown in Figure 16, to AC couple the signal to the transformer eliminates the possibility for DC current to flow under any conditions. These capacitors should be sized large enough to not impair the frequency response characteristics required for the data transmission.

Another important fault related concern has to do with very fast high voltage transients appearing on the telephone line (lightning strikes for example). TransZorbs[®], varistors and other transient protection devices are often used to absorb the transient energy, but in doing so also

create fast voltage transitions themselves that can be coupled through the transformer to the outputs of the line driver. Several hundred volt transient signals can appear at the primary windings of the transformer with current into the driver outputs limited only by the back termination resistors. While the LT1739 has clamps to the supply rails at the output pins, they may not be large enough to handle the significant transient energy. External clamping diodes, such as BAV99s, at each end of the transformer primary help to shunt this destructive transient energy away from the amplifier outputs.

TransZorb is a registered trademark of General Instruments, GSI

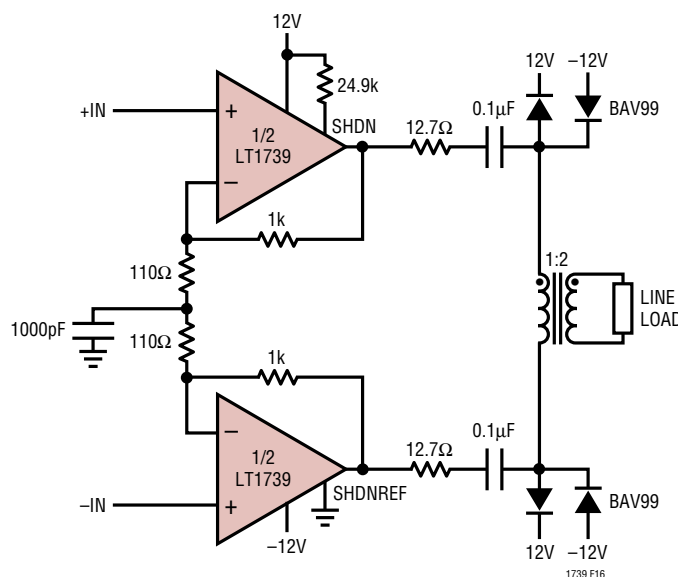

Figure 16. Protecting the Driver Against Load Faults and Line Transients

APPLICATIONS INFORMATION

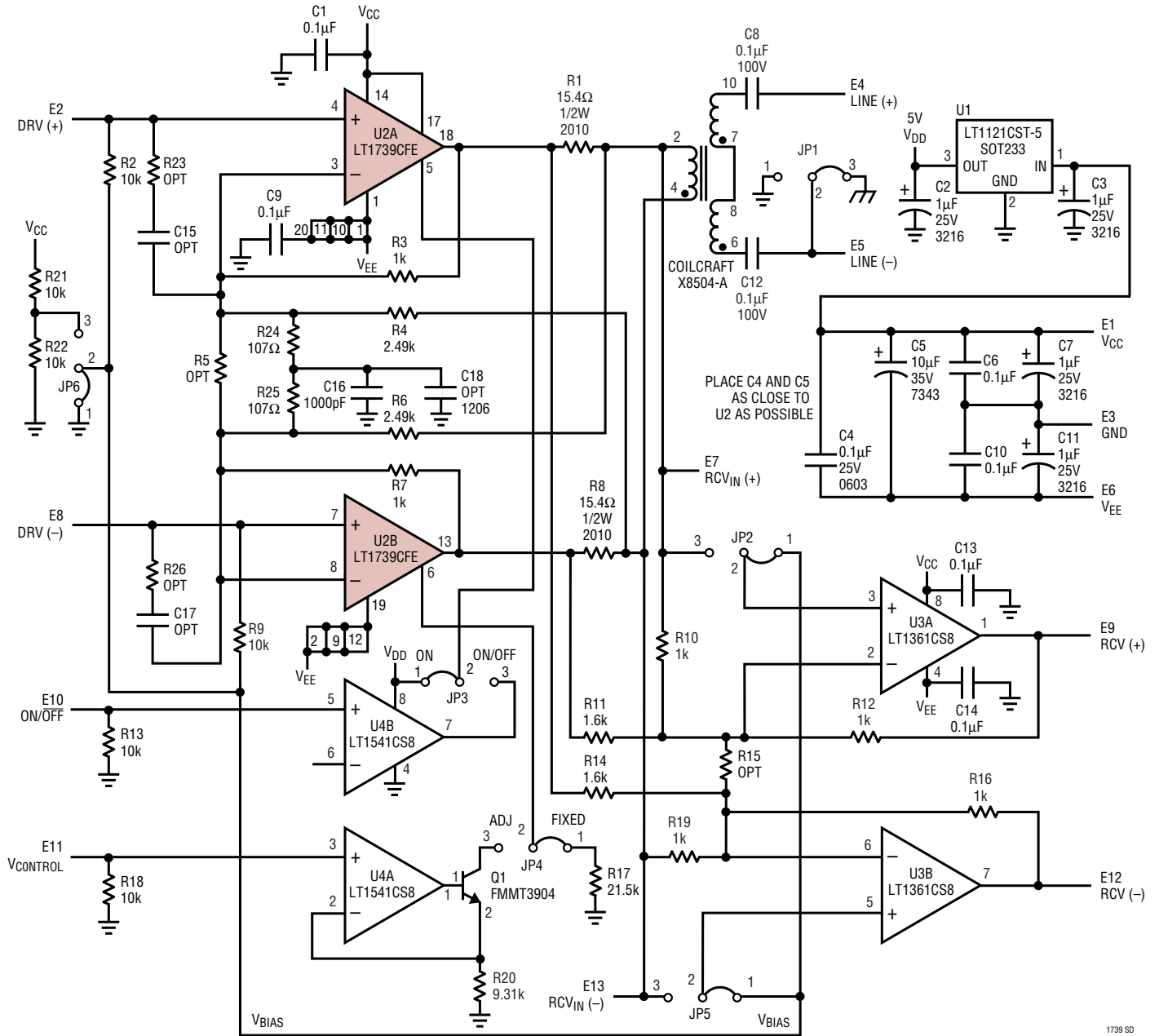
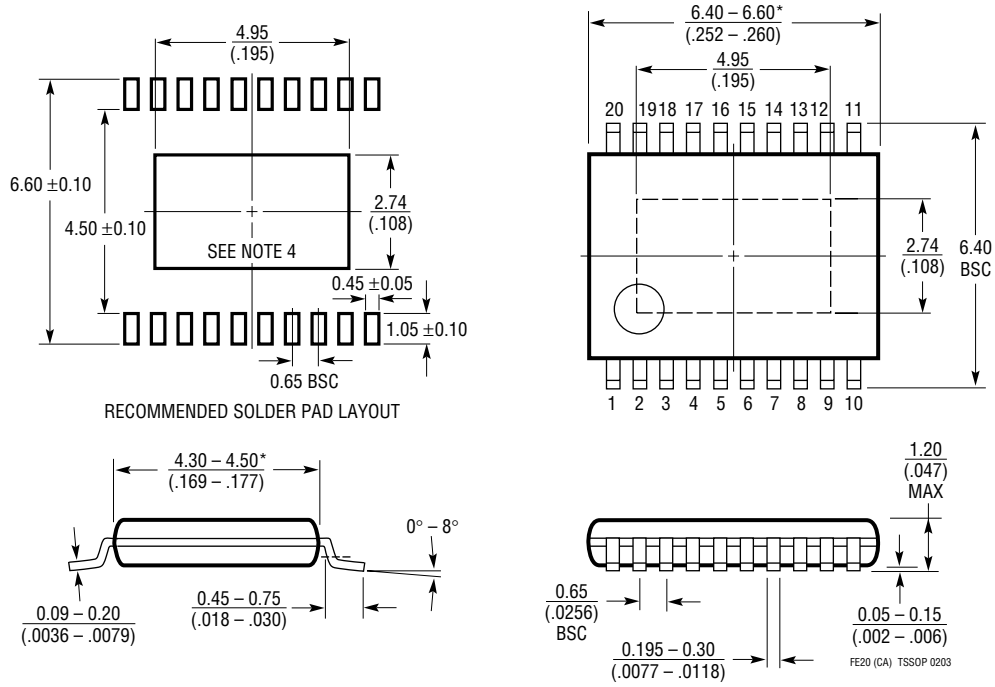

Figure 17. LT1739, LT1361 ADSL Demo Board (DC306A-C)

1739 SD

PACKAGE DESCRIPTION

FE Package
20-Lead Plastic TSSOP (4.4mm)
 (Reference LTC DWG # 05-08-1663)
Exposed Pad Variation CA



- NOTE:
1. CONTROLLING DIMENSION: MILLIMETERS
 2. DIMENSIONS ARE IN $\frac{\text{MILLIMETERS}}{\text{(INCHES)}}$
 3. DRAWING NOT TO SCALE
 4. RECOMMENDED MINIMUM PCB METAL SIZE FOR EXPOSED PAD ATTACHMENT
 *DIMENSIONS DO NOT INCLUDE MOLD FLASH. MOLD FLASH SHALL NOT EXCEED 0.150mm (.006") PER SIDE

PACKAGE DESCRIPTION

UE12 Package
12-Lead Plastic DFN (3mm × 4mm)
 (Reference LTC DWG # 05-08-1695)

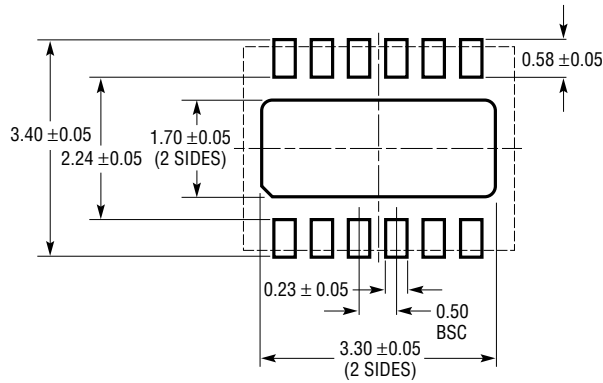

RECOMMENDED SOLDER PAD PITCH AND DIMENSIONS

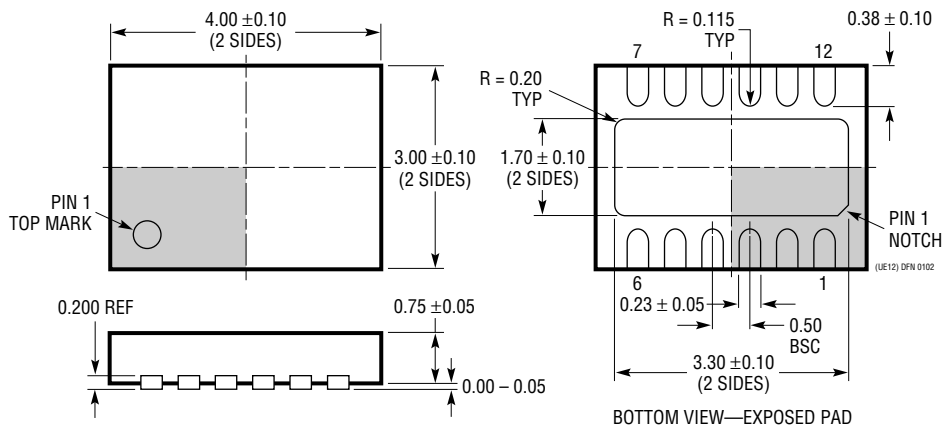

NOTE:

1. DRAWING PROPOSED TO BE MADE IS A VARIATION OF VERSION (WGED) IN JEDEC PACKAGE OUTLINE M0-229
2. ALL DIMENSIONS ARE IN MILLIMETERS
3. DIMENSIONS OF EXPOSED PAD ON BOTTOM OF PACKAGE DO NOT INCLUDE MOLD FLASH. MOLD FLASH, IF PRESENT, SHALL NOT EXCEED 0.15mm ON ANY SIDE
4. EXPOSED PAD SHALL BE SOLDER PLATED

TYPICAL APPLICATION

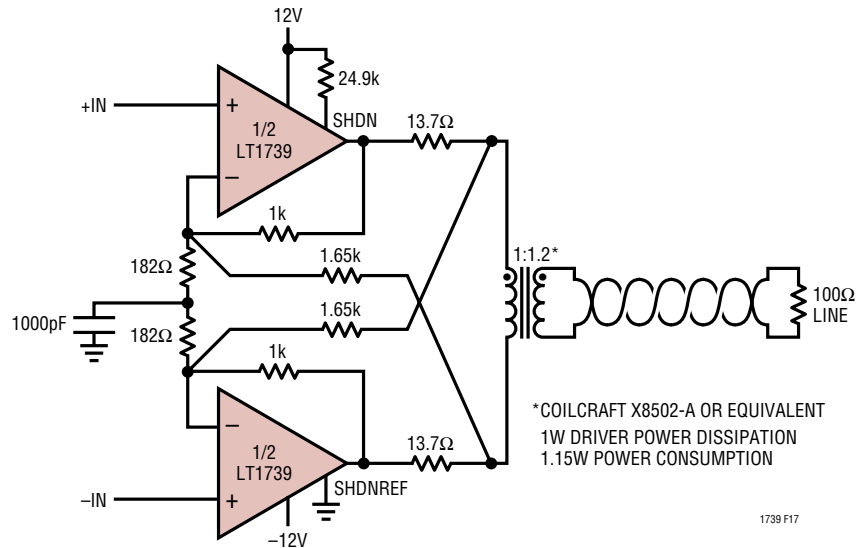

Figure 18. ADSL Line Driver Using Active Termination

RELATED PARTS

PART NUMBER	DESCRIPTION	COMMENTS
LT1361	Dual 50MHz, 800V/μs Op Amp	±15V Operation, 1mV V _{OS} , 1μA I _B
LT1794	Dual 500mA, 200MHz xDSL Line Driver	ADSL CO Driver, Extended Output Swing, Low Power
LT1795	Dual 500mA, 50MHz Current Feedback Amplifier	Shutdown/Current Set Function, ADSL CO Driver
LT1813	Dual 100MHz, 750V/μs, 8nV/√Hz Op Amp	Low Noise, Low Power Differential Receiver, 4mA/Amplifier
LT1886	Dual 200mA, 700MHz Op Amp	12V Operation, 7mA/Amplifier, ADSL Modem Line Driver
LT1969	Dual 200mA, 700MHz Op Amp with Power Control	12V Operation, MSOP Package, ADSL Modem Line Driver
LT6300	Dual 500mA, 200MHz xDSL Line Driver	ADSL CO Driver in SSOP Package

X-ON Electronics

Largest Supplier of Electrical and Electronic Components

Click to view similar products for [High Speed Operational Amplifiers](#) category:

Click to view products by [Analog Devices](#) manufacturer:

Other Similar products are found below :

[NJU7047RB1-TE2](#) [LTC6226IS8#PBF](#) [LTC6226HS8#PBF](#) [LT1058ACN](#) [LT1206CR](#) [LT1058ISW](#) [THS4222DGNR](#) [OPA2677IDDAR](#)
[THS6042ID](#) [THS4221DBVR](#) [THS4081CD](#) [ADA4858-3ACPZ-R7](#) [LT6202IS5#TRMPBF](#) [LT1206CR#PBF](#) [LTC6253CMS8#PBF](#)
[LT1813CDD#PBF](#) [ADA4851-4YRUZ-RL](#) [LT1037IN8#PBF](#) [LTC6401CUD-20#PBF](#) [LT1192CN8#PBF](#) [LTC6401IUD-26#PBF](#)
[LT1037ACN8#PBF](#) [LTC6253CTS8#TRMPBF](#) [LT1399HVCS#PBF](#) [LT1993CUD-2#PBF](#) [LT6203CDD#PBF](#) [LT1722CS8#PBF](#)
[LT1208CN8#PBF](#) [LT1222CN8#PBF](#) [LT6203IDD#PBF](#) [LT6411IUD#PBF](#) [LTC6400CUD-26#PBF](#) [LTC6400CUD-8#PBF](#) [LT6211IDD#PBF](#)
[OP27EN8#PBF](#) [LT1810IMS8#PBF](#) [OP37EN8#PBF](#) [LTC6253IMS8#PBF](#) [LT1360CS8](#) [OPA2132PAG4](#) [OPA2691I-14D](#) [OPA4353UA/2K5](#)
[OPA690IDRG4](#) [LMH6723MFX/NOPB](#) [5962-9151901MPA](#) [ADP5302ACPZ-3-R7](#) [AD8007AKSZ-REEL7](#) [AD8008ARMZ](#) [AD8009JRTZ-](#)
[REEL7](#) [AD8010ANZ](#)