

# Single/Dual/Quad 100V/ $\mu$ s, 85MHz, Rail-to-Rail Input and Output Op Amps

## FEATURES

- **Slew Rate: 100V/ $\mu$ s**
- **Gain Bandwidth Product: 85MHz**
- **Input Common Mode Range Includes Both Rails**
- **Output Swings Rail-to-Rail**
- **Low Quiescent Current: 3mA Max per Amplifier**
- Large Output Current: 42mA
- Voltage Noise: 21nV/ $\sqrt{\text{Hz}}$
- Power Supply Rejection: 90dB
- Open-Loop Gain: 60V/mV
- Operating Temperature Range:  $-40^{\circ}\text{C}$  to  $85^{\circ}\text{C}$
- Single Available in the 8-Pin SO and 5-Pin Low Profile (1mm) SOT-23 (ThinSOT™) Package
- Dual Available in 8-Lead DFN and SO Packages
- Quad Available in the 14-Pin Narrow SO Package

## APPLICATIONS

- Low Voltage, High Frequency Signal Processing
- Driving A/D Converters
- Rail-to-Rail Buffer Amplifiers
- Active Filters
- Video Line Driver

LT, LTC and LT are registered trademarks of Linear Technology Corporation.  
ThinSOT is a trademark of Linear Technology Corporation.

## DESCRIPTION

The LT<sup>®</sup>1803/LT1804/LT1805 are single/dual/quad, low power, high speed rail-to-rail input and output operational amplifiers with excellent DC performance. The LT1803/LT1804/LT1805 feature reduced supply current, lower input offset voltage, lower input bias current and higher DC gain than other devices with comparable bandwidth and slew rate.

Typically, the LT1803/LT1804/LT1805 have an input offset voltage of 350 $\mu$ V, an input bias current of 125nA and an open-loop gain of 60V/mV.

The LT1803/LT1804/LT1805 have an input range that includes both supply rails and an output that swings within 20mV of either supply rail to maximize the signal dynamic range in low supply applications.

The LT1803/LT1804/LT1805 are specified at 3V, 5V and  $\pm 5$ V supplies and typically maintain their performance for supplies from 2.3V to 12.6V. The inputs can be driven beyond the supplies without damage or phase reversal of the output.

The LT1803 is available in the 8-pin SO package with the standard op amp pinout and in the 5-pin SOT-23 package. The LT1804 is available in 8-pin DFN and SO packages with the standard op amp pinouts. The LT1805 features the standard quad op amp configuration and is available in a 14-pin plastic SO package.

## TYPICAL APPLICATION

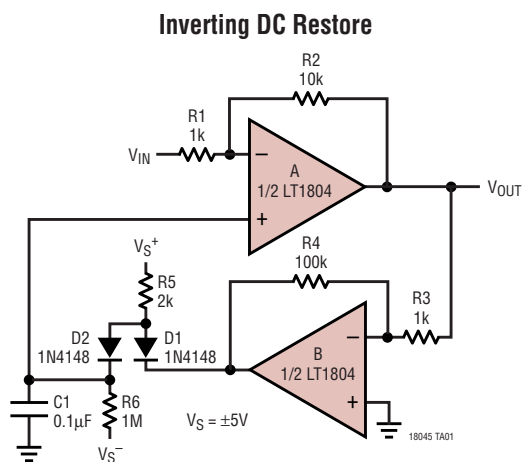

**Inverting DC Restore Circuit Response**



# LT1803/LT1804/LT1805

## ABSOLUTE MAXIMUM RATINGS (Note 1)

Total Supply Voltage ( $V^+$ to $V^-$ ) .....	12.6V	Maximum Junction Temperature (DD Package) ..	125°C
Input Current (Note 2) .....	$\pm 10\text{mA}$	Storage Temperature Range .....	-65°C to 150°C
Output Short-Circuit Duration (Note 3) .....	Indefinite	Storage Temperature Range (DD Package) .....	-65°C to 125°C
Operating Temperature Range (Note 4) ..	-40°C to 85°C	Lead Temperature (Soldering, 10 sec) .....	300°C
Specified Temperature Range (Note 5) ...	-40°C to 85°C		
Maximum Junction Temperature .....	150°C		

## PACKAGE/ORDER INFORMATION

 <p>S5 PACKAGE 5-LEAD PLASTIC TSOT-23 <math>T_{JMAX} = 150^{\circ}\text{C}</math>, <math>\theta_{JA} = 250^{\circ}\text{C/W}</math></p>		 <p>S8 PACKAGE 8-LEAD PLASTIC SO <math>T_{JMAX} = 150^{\circ}\text{C}</math>, <math>\theta_{JA} = 190^{\circ}\text{C/W}</math></p>	
ORDER PART NUMBER	S5 PART MARKING*	ORDER PART NUMBER	S8 PART MARKING
LT1803CS5 LT1803IS5	LTAFN	LT1803CS8 LT1803IS8	1803 1803I
 <p>DD PACKAGE 8-LEAD (3mm x 3mm) PLASTIC DFN <math>T_{JMAX} = 125^{\circ}\text{C}</math>, <math>\theta_{JA} = 160^{\circ}\text{C/W}</math> UNDERSIDE METAL INTERNALLY CONNECTED TO <math>V^-</math> (PCB CONNECTION OPTIONAL)</p>		 <p>S8 PACKAGE 8-LEAD PLASTIC SO <math>T_{JMAX} = 150^{\circ}\text{C}</math>, <math>\theta_{JA} = 190^{\circ}\text{C/W}</math></p>	
ORDER PART NUMBER	DD PART MARKING*	ORDER PART NUMBER	S8 PART MARKING
LT1804CDD LT1804IDD	LADJ	LT1804CS8 LT1804IS8	1804 1804I
		ORDER PART NUMBER	
		LT1805CS LT1805IS	

Consult LTC Marketing for parts specified with wider operating temperature ranges.  
\*The temperature grades are identified by a label on the shipping container.

## ELECTRICAL CHARACTERISTICS

$T_A = 25^\circ\text{C}$ ;  $V_S = 5\text{V}, 0\text{V}$ ;  $V_S = 3\text{V}, 0\text{V}$ ;  $V_{CM} = V_{OUT} = \text{half supply}$ , unless otherwise noted

SYMBOL	PARAMETER	CONDITIONS	MIN	TYP	MAX	UNITS
$V_{OS}$	Input Offset Voltage	$V_{CM} = 0\text{V}$		0.35	2	mV
		$V_{CM} = 0\text{V}$ (DD Package)		1.00	3	mV
		$V_{CM} = 0\text{V}$ (SOT-23 Package)		1.00	5	mV
		$V_{CM} = V_S$		1.50	8	mV
$\Delta V_{OS}$	Input Offset Shift	$V_{CM} = 0\text{V}$ to $V_S - 2\text{V}$		0.125	0.50	mV
	Input Offset Voltage Match (Channel-to-Channel) (Note 9)	$V_{CM} = 0\text{V}$		0.5	3.5	mV
		$V_{CM} = 0\text{V}$ (DD Package)		1.0	5.0	mV
$I_B$	Input Bias Current	$V_{CM} = 1\text{V}$		125	750	nA
		$V_{CM} = V_S$		3	5.5	$\mu\text{A}$
	Input Bias Current Match (Channel-to-Channel) (Note 9)	$V_{CM} = 1\text{V}$		100	1250	nA
		$V_{CM} = V_S$		100	1500	nA
$I_{OS}$	Input Offset Current	$V_{CM} = 1\text{V}$		100	1000	nA
		$V_{CM} = V_S$		50	1000	nA
	Input Noise Voltage	0.1Hz to 10Hz		4		$\mu\text{V}_{P-P}$
$e_n$	Input Noise Voltage Density	$f = 10\text{kHz}$		21		$\text{nV}/\sqrt{\text{Hz}}$
$i_n$	Input Noise Current Density	$f = 10\text{kHz}$		2.5		$\text{pA}/\sqrt{\text{Hz}}$
$C_{IN}$	Input Capacitance			2		pF
$A_{VOL}$	Large-Signal Voltage Gain	$V_S = 5\text{V}, V_O = 0.5\text{V}$ to $4.5\text{V}, R_L = 1\text{k}$ to $V_S/2$	20	60		V/mV
		$V_S = 5\text{V}, V_O = 1\text{V}$ to $4\text{V}, R_L = 100\Omega$ to $V_S/2$	2	4.5		V/mV
		$V_S = 3\text{V}, V_O = 0.5\text{V}$ to $2.5\text{V}, R_L = 1\text{k}$ to $V_S/2$	15	45		V/mV
CMRR	Common Mode Rejection Ratio	$V_S = 5\text{V}, V_{CM} = 0\text{V}$ to $3\text{V}$	75	96		dB
		$V_S = 3\text{V}, V_{CM} = 0\text{V}$ to $1\text{V}$	66	90		dB
	CMRR Match (Channel-to-Channel) (Note 9)	$V_S = 5\text{V}, V_{CM} = 0\text{V}$ to $3\text{V}$	69	91		dB
		$V_S = 3\text{V}, V_{CM} = 0\text{V}$ to $1\text{V}$	60	85		dB
	Input Common Mode Range		0		$V_S$	V
PSRR	Power Supply Rejection Ratio	$V_S = 2.5\text{V}$ to $10\text{V}, V_{CM} = 0\text{V}$	68	90		dB
		$V_S = 2.5\text{V}$ to $10\text{V}, V_{CM} = 0\text{V}$	62	90		dB
	Minimum Supply Voltage (Note 6)			2.3	2.5	V
$V_{OL}$	Output Voltage Swing Low (Note 7)	No Load		17	60	mV
		$I_{SINK} = 5\text{mA}$		80	150	mV
		$I_{SINK} = 15\text{mA}$		180	300	mV
$V_{OH}$	Output Voltage Swing High (Note 7)	No Load		17	60	mV
		$I_{SOURCE} = 5\text{mA}$		125	250	mV
		$I_{SOURCE} = 15\text{mA}$		350	600	mV
$I_{SC}$	Short-Circuit Current (Note 3)	$V_S = 5\text{V}$	20	42		mA
		$V_S = 3\text{V}$	18	34		mA
$I_S$	Supply Current per Amplifier			2.7	3	mA
GBW	Gain Bandwidth Product	$V_S = 5\text{V}$ , Frequency = $2\text{MHz}$ , $R_L = 1\text{k}$ to $2.5\text{V}$	50	85		MHz
SR	Slew Rate	$V_S = 5\text{V}, A_V = -1, R_L = 1\text{k}$ to $V_S/2, V_O = 0.5\text{V}$ to $4.5\text{V}$ Measured at $V_O = 1.5\text{V}, 3.5\text{V}$	65	100		V/ $\mu\text{s}$
FPBW	Full Power Bandwidth (Note 10)	$V_S = 5\text{V}, A_V = -1, V_O = 0.5\text{V}$ to $4.5\text{V}, R_L = 1\text{k}$ to $V_S/2$		8		MHz
HD	Harmonic Distortion	$V_S = 5\text{V}, A_V = 1, R_L = 1\text{k}, V_O = 2V_{P-P}, f_C = 1\text{MHz}$		-75		dBc
$t_S$	Settling Time	0.01%, $V_S = 5\text{V}, V_{STEP} = 2\text{V}, A_V = 1, R_L = 1\text{k}$		350		ns
$\Delta G$	Differential Gain (NTSC)	$V_S = 5\text{V}, A_V = 2, R_L = 150\Omega$		0.15		%
$\Delta\theta$	Differential Phase (NTSC)	$V_S = 5\text{V}, A_V = 2, R_L = 150\Omega$		1		Deg

**ELECTRICAL CHARACTERISTICS** The ● denotes specifications which apply over the  $0^{\circ}\text{C} \leq T_A \leq 70^{\circ}\text{C}$  temperature range.  $V_S = 5\text{V}, 0\text{V}; V_S = 3\text{V}, 0\text{V}; V_{CM} = V_{OUT} = \text{half supply unless otherwise noted.}$

SYMBOL	PARAMETER	CONDITIONS		MIN	TYP	MAX	UNITS
$V_{OS}$	Input Offset Voltage	$V_{CM} = 0\text{V}$	●	0.50	3.5		mV
		$V_{CM} = 0\text{V}$ (DD Package)	●	1.25	5		mV
		$V_{CM} = 0\text{V}$ (SOT-23 Package)	●	1.25	6		mV
		$V_{CM} = V_S$	●	1.60	8.5		mV
$\Delta V_{OS}$	Input Offset Shift	$V_{CM} = 0\text{V}$ to $V_S - 2\text{V}$	●	0.05	0.8		mV
	Input Offset Voltage Match (Channel-to-Channel) (Note 9)	$V_{CM} = 0\text{V}$	●	0.75	5.5		mV
		$V_{CM} = 0\text{V}$ (DD Package)	●	1.50	7.5		mV
$V_{OS\ TC}$	Input Offset Voltage Drift (Note 8)		●	10	35		$\mu\text{V}/^{\circ}\text{C}$
$I_B$	Input Bias Current	$V_{CM} = 1\text{V}$	●	150	1100		nA
		$V_{CM} = V_S - 0.2\text{V}$	●	3.2	6		$\mu\text{A}$
	Input Bias Current Match (Channel-to-Channel) (Note 9)	$V_{CM} = 1\text{V}$	●	120	1500		nA
		$V_{CM} = V_S - 0.2\text{V}$	●	120	1800		nA
$I_{OS}$	Input Offset Current	$V_{CM} = 1\text{V}$	●	100	1400		nA
		$V_{CM} = V_S - 0.2\text{V}$	●	50	1400		nA
$A_{VOL}$	Large-Signal Voltage Gain	$V_S = 5\text{V}, V_O = 0.5\text{V}$ to $4.5\text{V}, R_L = 1\text{k}$ to $V_S/2$	●	15	50		V/mV
		$V_S = 5\text{V}, V_O = 1\text{V}$ to $4\text{V}, R_L = 100\Omega$ to $V_S/2$	●	1.4	3.7		V/mV
		$V_S = 3\text{V}, V_O = 0.5\text{V}$ to $2.5\text{V}, R_L = 1\text{k}$ to $V_S/2$	●	10	40		V/mV
CMRR	Common Mode Rejection Ratio	$V_S = 5\text{V}, V_{CM} = 0\text{V}$ to $3\text{V}$	●	71	95		dB
		$V_S = 3\text{V}, V_{CM} = 0\text{V}$ to $1\text{V}$	●	61	90		dB
	CMRR Match (Channel-to-Channel) (Note 9)	$V_S = 5\text{V}, V_{CM} = 0\text{V}$ to $3\text{V}$	●	65	90		dB
		$V_S = 3\text{V}, V_{CM} = 0\text{V}$ to $1\text{V}$	●	55	85		dB
	Input Common Mode Range		●	0	$V_S$		V
PSRR	Power Supply Rejection Ratio	$V_S = 2.5\text{V}$ to $10\text{V}, V_{CM} = 0\text{V}$	●	65	87		dB
		PSRR Match (Channel-to-Channel) (Note 9)	●	59	87		dB
	Minimum Supply Voltage (Note 6)		●	2.3	2.5		V
$V_{OL}$	Output Voltage Swing Low (Note 7)	No Load	●	19	80		mV
		$I_{SINK} = 5\text{mA}$	●	100	225		mV
		$I_{SINK} = 15\text{mA}$	●	200	450		mV
$V_{OH}$	Output Voltage Swing High (Note 7)	No Load	●	19	80		mV
		$I_{SOURCE} = 5\text{mA}$	●	150	350		mV
		$I_{SOURCE} = 15\text{mA}$	●	450	900		mV
$I_{SC}$	Short-Circuit Current (Note 3)	$V_S = 5\text{V}$	●	17	40		mA
		$V_S = 3\text{V}$	●	15	28		mA
$I_S$	Supply Current per Amplifier		●	3	3.75		mA
GBW	Gain Bandwidth Product	$V_S = 5\text{V}, \text{Frequency} = 2\text{MHz}, R_L = 1\text{k}$ to $2.5\text{V}$	●	45	82		MHz
SR	Slew Rate	$V_S = 5\text{V}, A_V = -1, R_L = 1\text{k}$ to $V_S/2, V_O = 0.5\text{V}$ to $4.5\text{V}$ Measured at $V_O = 1.5\text{V}, 3.5\text{V}$	●	45	93		V/ $\mu\text{s}$

**ELECTRICAL CHARACTERISTICS** The ● denotes specifications which apply over the  $-40^{\circ}\text{C} \leq T_A \leq 85^{\circ}\text{C}$  temperature range.  $V_S = 5\text{V}, 0\text{V}$ ;  $V_S = 3\text{V}, 0\text{V}$ ;  $V_{CM} = V_{OUT} = \text{half supply unless otherwise noted. (Note 5)}$

SYMBOL	PARAMETER	CONDITIONS	MIN	TYP	MAX	UNITS
$V_{OS}$	Input Offset Voltage	$V_{CM} = 0\text{V}$	●	0.7	4	mV
		$V_{CM} = 0\text{V}$ (DD Package)	●	1.5	6.5	mV
		$V_{CM} = 0\text{V}$ (SOT-23 Package)	●	1.5	7	mV
		$V_{CM} = V_S$	●	1.7	9	mV
$\Delta V_{OS}$	Input Offset Shift	$V_{CM} = 0\text{V}$ to $V_S - 2\text{V}$	●	0.125	1.00	mV
	Input Offset Voltage Match (Channel-to-Channel) (Note 9)	$V_{CM} = 0\text{V}$	●	1	6.5	mV
		$V_{CM} = 0\text{V}$ (DD Package)	●	2	9	mV
$V_{OS\ TC}$	Input Offset Voltage Drift (Note 8)		●	10	35	$\mu\text{V}/^{\circ}\text{C}$
$I_B$	Input Bias Current	$V_{CM} = 1\text{V}$	●	200	1500	nA
		$V_{CM} = V_S - 0.2\text{V}$	●	3.4	6.5	$\mu\text{A}$
	Input Bias Current Match (Channel-to-Channel) (Note 9)	$V_{CM} = 1\text{V}$	●	150	2000	nA
		$V_{CM} = V_S - 0.2\text{V}$	●	150	2200	nA
$I_{OS}$	Input Offset Current	$V_{CM} = 1\text{V}$ $V_{CM} = V_S - 0.2\text{V}$	● ●	100 50	1600 1600	nA nA
$A_{VOL}$	Large-Signal Voltage Gain	$V_S = 5\text{V}, V_O = 0.5\text{V}$ to $4.5\text{V}, R_L = 1\text{k}$ to $V_S/2$	●	12	48	V/mV
		$V_S = 5\text{V}, V_O = 1.5\text{V}$ to $3.5\text{V}, R_L = 100\Omega$ to $V_S/2$	●	1.3	4.8	V/mV
		$V_S = 3\text{V}, V_O = 0.5\text{V}$ to $2.5\text{V}, R_L = 1\text{k}$ to $V_S/2$	●	8	35	V/mV
CMRR	Common Mode Rejection Ratio	$V_S = 5\text{V}, V_{CM} = 0\text{V}$ to $3\text{V}$	●	69	95	dB
		$V_S = 3\text{V}, V_{CM} = 0\text{V}$ to $1\text{V}$	●	60	90	dB
	CMRR Match (Channel-to-Channel) (Note 9)	$V_S = 5\text{V}, V_{CM} = 0\text{V}$ to $3\text{V}$ $V_S = 3\text{V}, V_{CM} = 0\text{V}$ to $1\text{V}$	● ●	63 54	90 85	dB dB
	Input Common Mode Range		●	0	$V_S$	V
PSRR	Power Supply Rejection Ratio	$V_S = 2.5\text{V}$ to $10\text{V}, V_{CM} = 0\text{V}$	●	64	86	dB
		PSRR Match (Channel-to-Channel) (Note 9)	●	58	86	dB
	Minimum Supply Voltage (Note 6)		●	2.3	2.5	V
$V_{OL}$	Output Voltage Swing Low (Note 7)	No Load	●	20	90	mV
		$I_{SINK} = 5\text{mA}$	●	100	250	mV
		$I_{SINK} = 10\text{mA}$	●	170	350	mV
$V_{OH}$	Output Voltage Swing High (Note 7)	No Load	●	20	90	mV
		$I_{SOURCE} = 5\text{mA}$	●	170	400	mV
		$I_{SOURCE} = 10\text{mA}$	●	300	600	mV
$I_{SC}$	Short-Circuit Current (Note 3)	$V_S = 5\text{V}$	●	12	35	mA
		$V_S = 3\text{V}$	●	11	27	mA
$I_S$	Supply Current per Amplifier		●	3.1	4.25	mA
GBW	Gain Bandwidth Product	$V_S = 5\text{V}$ , Frequency = $2\text{MHz}$ , $R_L = 1\text{k}$ to $2.5\text{V}$	●	40	77	MHz
SR	Slew Rate	$V_S = 5\text{V}, A_V = -1, R_L = 1\text{k}$ to $V_S/2, V_O = 0.5\text{V}$ to $4.5\text{V}$ Measured at $V_O = 1.5\text{V}, 3.5\text{V}$	●	30	70	V/ $\mu\text{s}$

**ELECTRICAL CHARACTERISTICS**  $T_A = 25^\circ\text{C}$ ,  $V_S = \pm 5\text{V}$ ,  $V_{CM} = 0\text{V}$ ,  $V_{OUT} = 0\text{V}$ , unless otherwise noted

SYMBOL	PARAMETER	CONDITIONS	MIN	TYP	MAX	UNITS
$V_{OS}$	Input Offset Voltage	$V_{CM} = -5\text{V}$		0.35	2.5	mV
		$V_{CM} = -5\text{V}$ (DD Package)		1.50	3.5	mV
		$V_{CM} = -5\text{V}$ (SOT-23 Package)		1.50	6	mV
		$V_{CM} = 5\text{V}$		1.50	8	mV
$\Delta V_{OS}$	Input Offset Shift	$V_{CM} = -5\text{V}$ to $3\text{V}$		0.3	1	mV
	Input Offset Voltage Match (Channel-to-Channel) (Note 9)	$V_{CM} = -5\text{V}$		0.5	4	mV
		$V_{CM} = -5\text{V}$ (DD Package)		1	5.5	mV
$I_B$	Input Bias Current	$V_{CM} = -4\text{V}$		125	750	nA
		$V_{CM} = 5\text{V}$		2.5	5.5	$\mu\text{A}$
	Input Bias Current Match (Channel-to-Channel) (Note 9)	$V_{CM} = -4\text{V}$		150	1250	nA
		$V_{CM} = 5\text{V}$		150	1500	nA
$I_{OS}$	Input Offset Current	$V_{CM} = -4\text{V}$		100	1000	nA
		$V_{CM} = 5\text{V}$		50	1000	nA
	Input Noise Voltage	0.1Hz to 10Hz		4		$\mu\text{V}_{P-P}$
$e_n$	Input Noise Voltage Density	$f = 10\text{kHz}$		21		$\text{nV}/\sqrt{\text{Hz}}$
$i_n$	Input Noise Current Density	$f = 10\text{kHz}$		2.5		$\text{pA}/\sqrt{\text{Hz}}$
$C_{IN}$	Input Capacitance	$f = 100\text{kHz}$		2		pF
$A_{VOL}$	Large-Signal Voltage Gain	$V_O = -4\text{V}$ to $4\text{V}$ , $R_L = 1\text{k}$	20	55		V/mV
		$V_O = -1.5\text{V}$ to $1.5\text{V}$ , $R_L = 100\Omega$	2	5		V/mV
CMRR	Common Mode Rejection Ratio	$V_{CM} = -5\text{V}$ to $3\text{V}$	78	96		dB
	CMRR Match (Channel-to-Channel) (Note 9)	$V_{CM} = -5\text{V}$ to $3\text{V}$	72	96		dB
	Input Common Mode Range		$V_S^-$		$V_S^+$	V
PSRR	Power Supply Rejection Ratio	$V_S^+ = 2.5\text{V}$ to $10\text{V}$ , $V_S^- = 0\text{V}$ , $V_{OUT} = V_S^+/2$	68	90		dB
	PSRR Match (Channel-to-Channel) (Note 9)	$V_S^+ = 2.5\text{V}$ to $10\text{V}$ , $V_S^- = 0\text{V}$ , $V_{OUT} = V_S^+/2$	62	90		dB
$V_{OL}$	Output Voltage Swing Low (Note 7)	No Load		17	60	mV
		$I_{SINK} = 5\text{mA}$		85	150	mV
		$I_{SINK} = 15\text{mA}$		200	300	mV
$V_{OH}$	Output Voltage Swing High (Note 7)	No Load		17	60	mV
		$I_{SOURCE} = 5\text{mA}$		125	250	mV
		$I_{SOURCE} = 15\text{mA}$		350	600	mV
$I_{SC}$	Short-Circuit Current (Note 3)		25	50		mA
$I_S$	Supply Current per Amplifier			2.5	3	mA
GBW	Gain Bandwidth Product	Frequency = $2\text{MHz}$ , $R_L = 1\text{k}$		83		MHz
SR	Slew Rate	$A_V = -1$ , $R_L = 1\text{k}$ , $V_O = \pm 4\text{V}$ Measured at $V_O = \pm 2\text{V}$		88		V/ $\mu\text{s}$
FPBW	Full Power Bandwidth (Note 10)	$V_O = 8V_{P-P}$ , $A_V = -1$ , $R_L = 1\text{k}$		4		MHz
HD	Harmonic Distortion	$A_V = 1$ , $R_L = 1\text{k}$ , $V_O = 2V_{P-P}$ , $f_C = 1\text{MHz}$		-75		dBc
$t_S$	Settling Time	0.01%, $V_{STEP} = 5\text{V}$ , $A_V = 1$ , $R_L = 1\text{k}$		500		ns
$\Delta G$	Differential Gain (NTSC)	$A_V = 2$ , $R_L = 150\Omega$		0.75		%
$\Delta\theta$	Differential Phase (NTSC)	$A_V = 2$ , $R_L = 150\Omega$		0.8		Deg

**ELECTRICAL CHARACTERISTICS** The ● denotes specifications which apply over the  $0^{\circ}\text{C} \leq T_A \leq 70^{\circ}\text{C}$  temperature range.  $V_S = \pm 5\text{V}$ ,  $V_{CM} = 0\text{V}$ ,  $V_{OUT} = 0\text{V}$  unless otherwise noted.

SYMBOL	PARAMETER	CONDITIONS	MIN	TYP	MAX	UNITS
$V_{OS}$	Input Offset Voltage	$V_{CM} = -5\text{V}$	●	0.5	3.5	mV
		$V_{CM} = -5\text{V}$ (DD Package)	●	1.5	5	mV
		$V_{CM} = -5\text{V}$ (SOT-23 Package)	●	1.5	7	mV
		$V_{CM} = 5\text{V}$	●	1.4	8.5	mV
$\Delta V_{OS}$	Input Offset Shift	$V_{CM} = -5\text{V}$ to $3\text{V}$	●	0.35	1.5	mV
		Input Offset Voltage Match (Channel-to-Channel) (Note 9)				
		$V_{CM} = -5\text{V}$	●	0.75	5.5	mV
		$V_{CM} = -5\text{V}$ (DD Package)	●	1.50	7.5	mV
$V_{OS\ TC}$	Input Offset Voltage Drift (Note 8)		●	10	35	$\mu\text{V}/^{\circ}\text{C}$
$I_B$	Input Bias Current	$V_{CM} = -4\text{V}$	●	175	1000	nA
		$V_{CM} = 4.8\text{V}$	●	2.5	6	$\mu\text{A}$
	Input Bias Current Match (Channel-to-Channel) (Note 9)	$V_{CM} = -4\text{V}$	●	175	1500	nA
		$V_{CM} = 4.8\text{V}$	●	175	1800	nA
$I_{OS}$	Input Offset Current	$V_{CM} = -4\text{V}$	●	100	1400	nA
		$V_{CM} = 4.8\text{V}$	●	50	1400	nA
$A_{VOL}$	Large-Signal Voltage Gain	$V_O = -4\text{V}$ to $4\text{V}$ , $R_L = 1\text{k}$	●	15	47	V/mV
		$V_O = -1.5\text{V}$ to $1.5\text{V}$ , $R_L = 100\Omega$	●	1.5	4.5	V/mV
CMRR	Common Mode Rejection Ratio	$V_{CM} = -5\text{V}$ to $3\text{V}$	●	74	95	dB
	CMRR Match (Channel-to-Channel) (Note 9)	$V_{CM} = -5\text{V}$ to $3\text{V}$	●	68	95	dB
	Input Common Mode Range		●	$V_S^-$	$V_S^+$	V
PSRR	Power Supply Rejection Ratio	$V_S^+ = 2.5\text{V}$ to $10\text{V}$ , $V_S^- = 0\text{V}$ , $V_{OUT} = V_S^+/2$	●	65	87	dB
	PSRR Match (Channel-to-Channel) (Note 9)	$V_S^+ = 2.5\text{V}$ to $10\text{V}$ , $V_S^- = 0\text{V}$ , $V_{OUT} = V_S^+/2$	●	59	87	dB
$V_{OL}$	Output Voltage Swing Low (Note 7)	No Load	●	19	80	mV
		$I_{SINK} = 5\text{mA}$	●	100	225	mV
		$I_{SINK} = 15\text{mA}$	●	220	475	mV
$V_{OH}$	Output Voltage Swing High (Note 7)	No Load	●	19	80	mV
		$I_{SOURCE} = 5\text{mA}$	●	150	350	mV
		$I_{SOURCE} = 15\text{mA}$	●	460	900	mV
$I_{SC}$	Short-Circuit Current (Note 3)		●	20	46	mA
$I_S$	Supply Current per Amplifier		●	2.8	3.75	mA
GBW	Gain Bandwidth Product	Frequency = $2\text{MHz}$ , $R_L = 1\text{k}$	●	80		MHz
SR	Slew Rate	$A_V = -1$ , $R_L = 1\text{k}$ , $V_O = \pm 4\text{V}$ , Measured at $V_O = \pm 2\text{V}$	●	84		V/ $\mu\text{s}$

## ELECTRICAL CHARACTERISTICS

The ● denotes specifications which apply over the  $-40^{\circ}\text{C} \leq T_A \leq 85^{\circ}\text{C}$  temperature range.  $V_S = \pm 5\text{V}$ ,  $V_{CM} = 0\text{V}$ ,  $V_{OUT} = 0\text{V}$  unless otherwise noted. (Note 5)

SYMBOL	PARAMETER	CONDITIONS	MIN	TYP	MAX	UNITS
$V_{OS}$	Input Offset Voltage	$V_{CM} = -5\text{V}$	●	1	4.0	mV
		$V_{CM} = -5\text{V}$ (DD Package)	●	2	6.5	mV
		$V_{CM} = -5\text{V}$ (SOT-23 Package)	●	2	8	mV
		$V_{CM} = 5\text{V}$	●	2	9	mV
$\Delta V_{OS}$	Input Offset Shift	$V_{CM} = -5\text{V}$ to $3\text{V}$	●	0.4	1.7	mV
	Input Offset Voltage Match (Channel-to-Channel) (Note 9)	$V_{CM} = -5\text{V}$	●	1	6.5	mV
		$V_{CM} = -5\text{V}$ (DD Package)	●	2	9.0	mV
$V_{OS\ TC}$	Input Offset Voltage Drift (Note 8)		●	10	35	$\mu\text{V}/^{\circ}\text{C}$
$I_B$	Input Bias Current	$V_{CM} = -4\text{V}$	●	250	1200	nA
		$V_{CM} = 4.8\text{V}$	●	2.5	6.5	$\mu\text{A}$
	Input Bias Current Match (Channel-to-Channel) (Note 9)	$V_{CM} = -4\text{V}$	●	200	2000	nA
		$V_{CM} = 4.8\text{V}$	●	250	2200	nA
$I_{OS}$	Input Offset Current	$V_{CM} = -4\text{V}$	●	100	1600	nA
		$V_{CM} = 4.8\text{V}$	●	50	1600	nA
$A_{VOL}$	Large-Signal Voltage Gain	$V_O = -4\text{V}$ to $4\text{V}$ , $R_L = 1\text{k}$	●	12	45	V/mV
		$V_O = -1\text{V}$ to $1\text{V}$ , $R_L = 100\Omega$	●	1.4	5.3	V/mV
CMRR	Common Mode Rejection Ratio	$V_{CM} = -5\text{V}$ to $3\text{V}$	●	73	95	dB
	CMRR Match (Channel-to-Channel) (Note 9)	$V_{CM} = -5\text{V}$ to $3\text{V}$	●	67	95	dB
	Input Common Mode Range		●	$V_S^-$	$V_S^+$	V
PSRR	Power Supply Rejection Ratio	$V_S^+ = 2.5\text{V}$ to $10\text{V}$ , $V_S^- = 0\text{V}$ , $V_{OUT} = V_S^+/2$	●	64	86	dB
	PSRR Match (Channel-to-Channel) (Note 9)	$V_S^+ = 2.5\text{V}$ to $10\text{V}$ , $V_S^- = 0\text{V}$ , $V_{OUT} = V_S^+/2$	●	58	86	dB
$V_{OL}$	Output Voltage Swing Low (Note 7)	No Load	●	20	90	mV
		$I_{SINK} = 5\text{mA}$	●	110	250	mV
		$I_{SINK} = 10\text{mA}$	●	170	350	mV
$V_{OH}$	Output Voltage Swing High (Note 7)	No Load	●	20	90	mV
		$I_{SOURCE} = 5\text{mA}$	●	170	400	mV
		$I_{SOURCE} = 10\text{mA}$	●	300	600	mV
$I_{SC}$	Short-Circuit Current (Note 3)		●	12.5	34	mA
$I_S$	Supply Current per Amplifier		●	2.9	4.25	mA
GBW	Gain Bandwidth Product	Frequency = $2\text{MHz}$ , $R_L = 1\text{k}$	●	75		MHz
SR	Slew Rate	$A_V = -1$ , $R_L = 1\text{k}$ , $V_O = \pm 4\text{V}$ , Measured at $V_O = \pm 2\text{V}$	●	65		V/ $\mu\text{s}$

**Note 1:** Absolute Maximum Ratings are those values beyond which the life of the device may be impaired.

**Note 2:** The inputs are protected by back-to-back diodes and by ESD diodes to supply rails. If the differential input voltage exceeds  $1.4\text{V}$ , or if an input is driven beyond the supply rails, the input current should be limited to less than  $10\text{mA}$ . This parameter is not tested; however it is guaranteed by characterization.

**Note 3:** A heat sink may be required to keep the junction temperature below the absolute maximum rating when the output is shorted indefinitely.

**Note 4:** The LT1803C/LT1803I, LT1804C/LT1804I and LT1805C/LT1805I are guaranteed functional over the temperature range of  $-40^{\circ}\text{C}$  and  $85^{\circ}\text{C}$ .

**Note 5:** The LT1803C/LT1804C/LT1805C are guaranteed to meet specified performance from  $0^{\circ}\text{C}$  to  $70^{\circ}\text{C}$ . The LT1803C/LT1804C/LT1805C are designed, characterized and expected to meet specified performance from

$-40^{\circ}\text{C}$  to  $85^{\circ}\text{C}$  but are not tested or QA sampled at these temperatures. The LT1803I/LT1804I/LT1805I are guaranteed to meet specified performance from  $-40^{\circ}\text{C}$  to  $85^{\circ}\text{C}$ .

**Note 6:** Minimum supply voltage is guaranteed by power supply rejection ratio test.

**Note 7:** Output voltage swings are measured between the output and power supply rails.

**Note 8:** This parameter is not 100% tested.

**Note 9:** Matching parameters are the difference between amplifiers A and D and between B and C on the LT1805; between the two amplifiers on the LT1804.

**Note 10:** Full power bandwidth is based on slew rate:

$$\text{FPBW} = \text{SR}/2\pi V_P$$



# TYPICAL PERFORMANCE CHARACTERISTICS

**$V_{OS}$  Distribution,  $V_{CM} = 0V$   
(SO-8, PNP Stage)**



180345 G01

**$V_{OS}$  Distribution,  $V_{CM} = 5V$   
(SO-8, NPN Stage)**

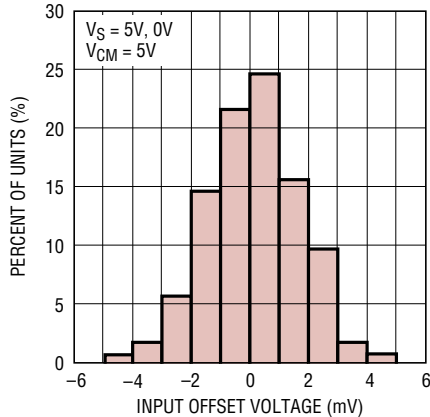

180345 G02

**$V_{OS}$  Distribution,  $V_{CM} = 0V$   
(SOT-23, PNP Stage)**

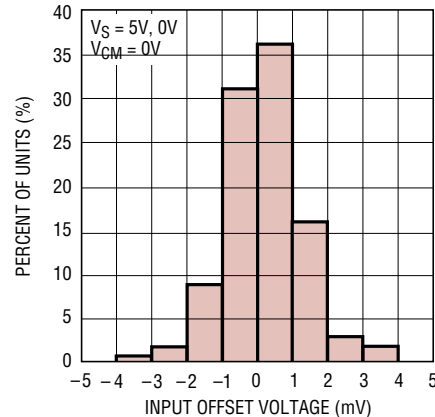

180345 G03

**$V_{OS}$  Distribution,  $V_{CM} = 5V$   
(SOT-23, NPN Stage)**

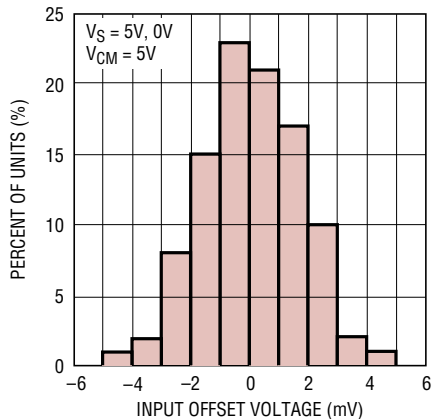

180345 G04

**Supply Current vs Supply Voltage**

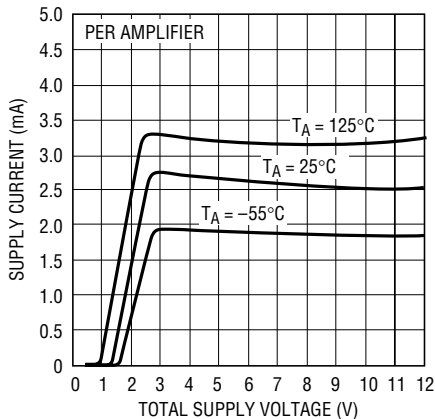

180345 G05

**Offset Voltage vs Input Common Mode Voltage**

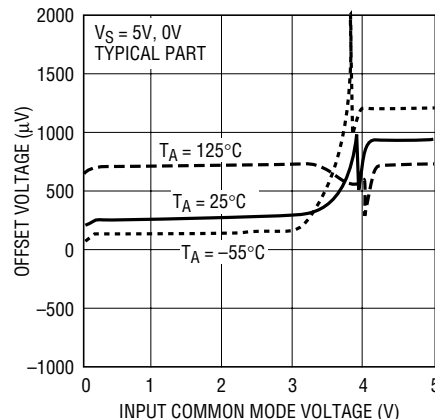

180345 G06

**Input Bias Current vs Common Mode Voltage**

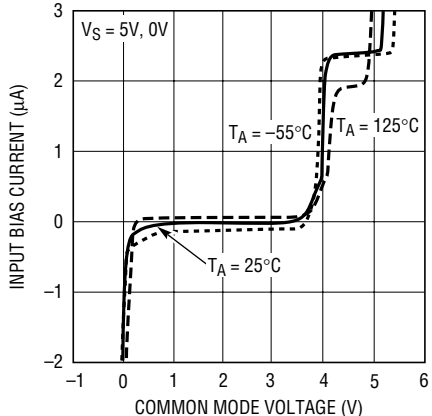

180345 G07

**Input Bias Current vs Temperature**

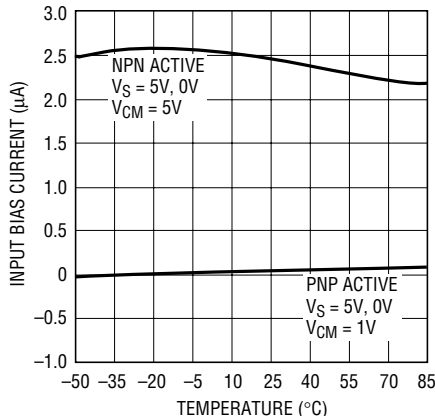

180345 G08

**Output Saturation Voltage vs Load Current (Output Low)**

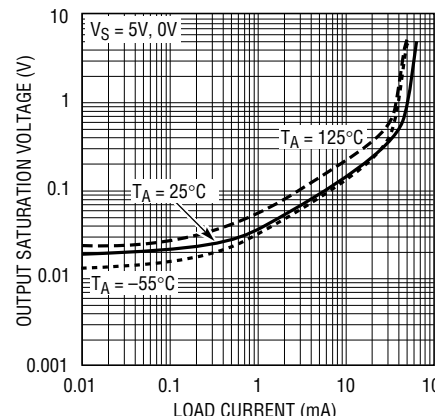

180345 G09

# TYPICAL PERFORMANCE CHARACTERISTICS

**Output Saturation Voltage vs Load Current (Output High)**

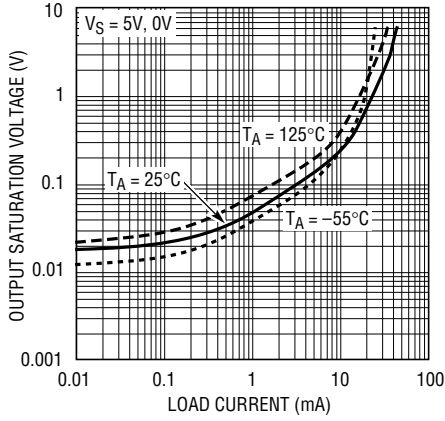

180345 G10

**Minimum Supply Voltage**

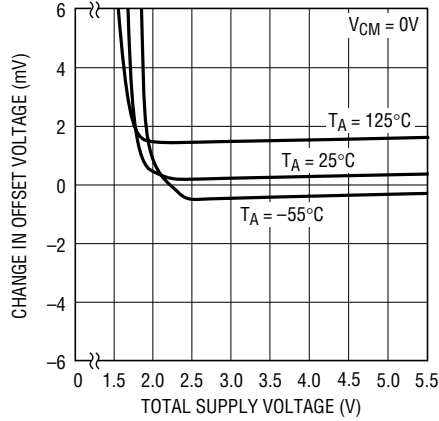

180345 G11

**Output Short-Circuit Current vs Power Supply Voltage**

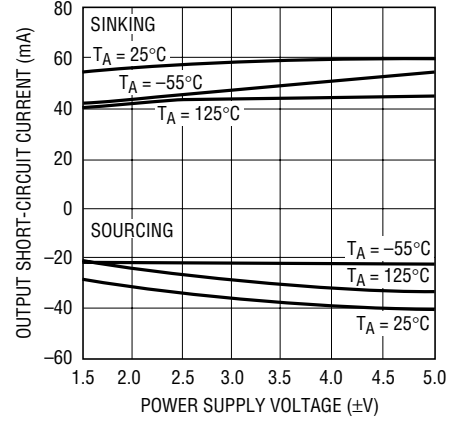

180345 G12

**Open-Loop Gain**

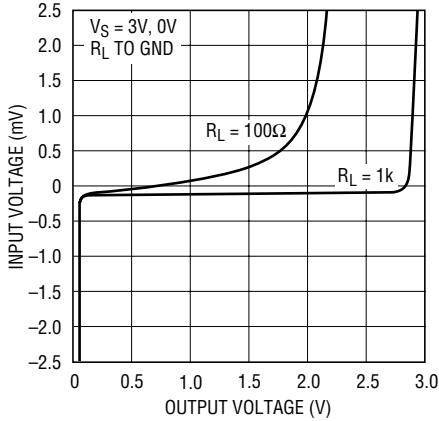

180345 G13

**Open-Loop Gain**

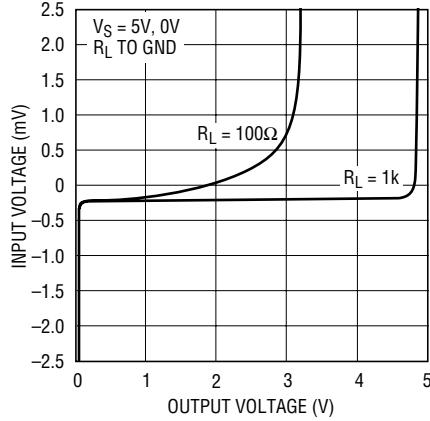

180345 G14

**Open-Loop Gain**

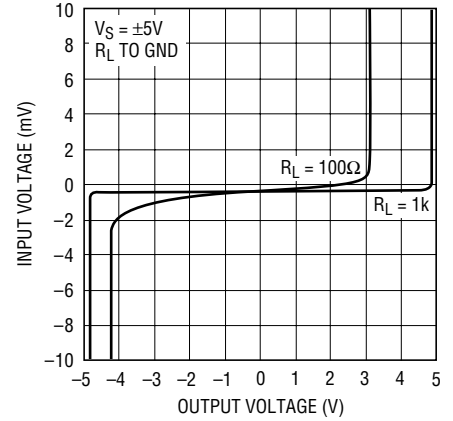

180345 G15

**Offset Voltage Change vs Output Current**

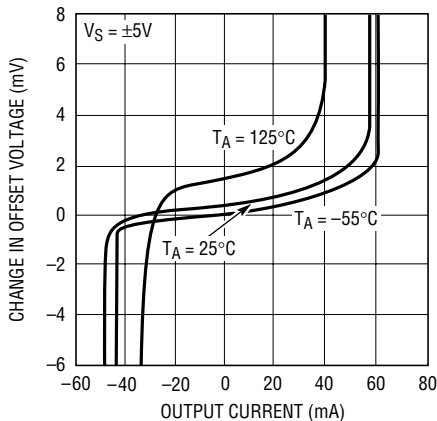

180345 G16

**Warm-Up Drift vs Time (LT1804S8)**

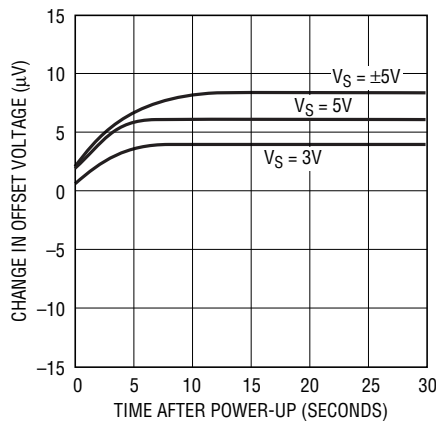

180345 G17

**Input Noise Voltage vs Frequency**

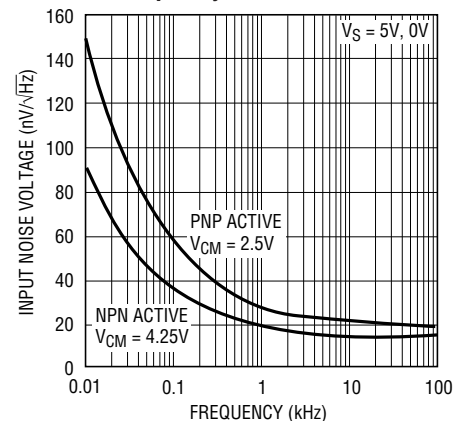

180345 G18

# TYPICAL PERFORMANCE CHARACTERISTICS

**Input Current Noise vs Frequency**

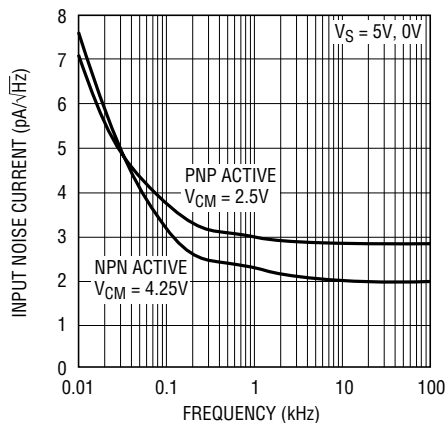

180345 G19

**0.1Hz to 10Hz Voltage Noise**

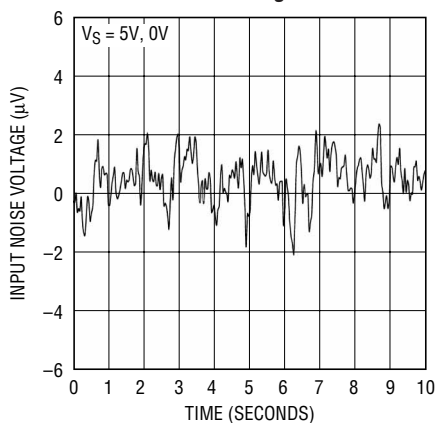

180345 G20

**Gain Bandwidth and Phase Margin vs Supply Voltage**



180345 G21

**Gain Bandwidth and Phase Margin vs Temperature**

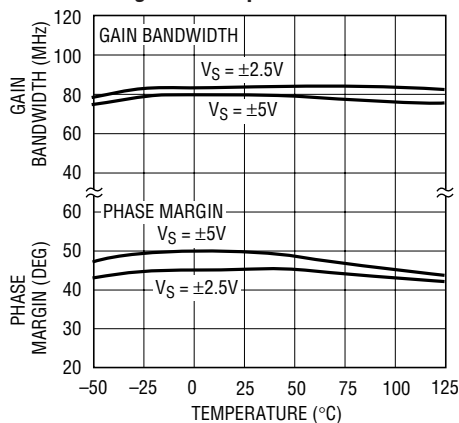

180345 G22

**Slew Rate vs Temperature**

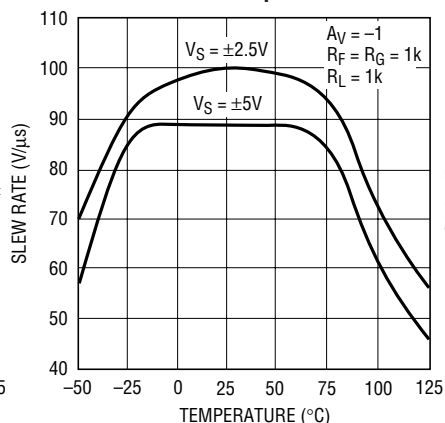

180345 G23

**Gain and Phase vs Frequency**



180345 G24

**Gain vs Frequency (A\_V = 1)**

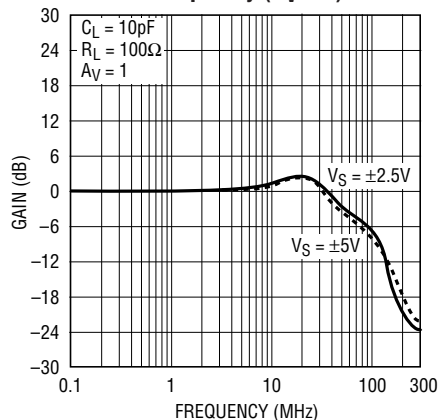

180345 G25

**Gain vs Frequency (A\_V = 2)**



180345 G26

**Output Impedance vs Frequency**

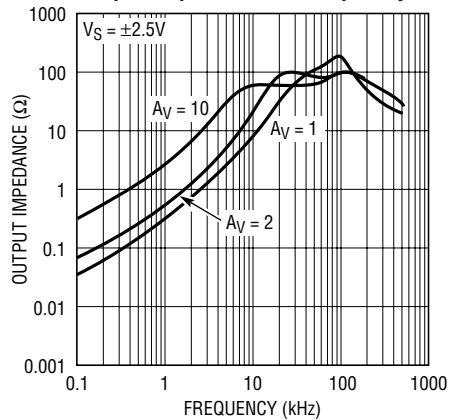

180345 G27

# TYPICAL PERFORMANCE CHARACTERISTICS

**Common Mode Rejection Ratio vs Frequency**



180345 G28

**Power Supply Rejection Ratio vs Frequency**



180345 G29

**Overshoot and Series Output Resistor vs Capacitive Load ( $A_V = 1$ )**



180345 G30

**Overshoot and Series Output Resistor vs Capacitive Load ( $A_V = 2$ )**



180345 G31

**Distortion vs Frequency ( $A_V = 1$ )**



180345 G32

**Distortion vs Frequency ( $A_V = 2$ )**

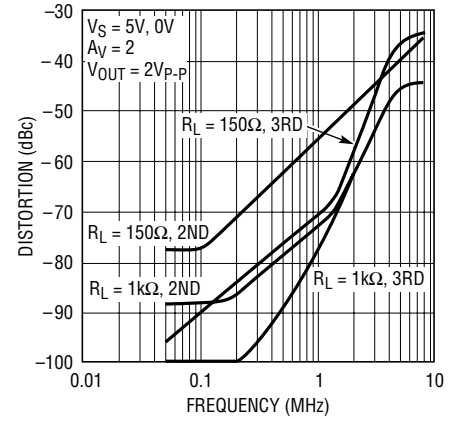

180345 G33

**Maximum Undistorted Output Signal vs Frequency**



180345 G34

**5V Large-Signal Response**

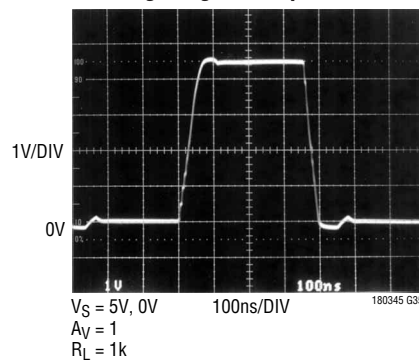

180345 G35

**5V Small-Signal Response**



180345 G36

## TYPICAL PERFORMANCE CHARACTERISTICS

**±5V Large-Signal Response**

**±5V Small-Signal Response**

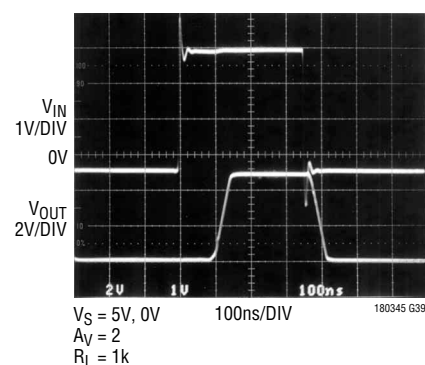
**Output Overdrive Recovery**

## APPLICATIONS INFORMATION

### Circuit Description

The LT1803/LT1804/LT1805 have input and output signal ranges from the negative power supply to the positive power supply. Figure 1 depicts a simplified schematic of one amplifier. The input stage is comprised of two differential amplifiers, a PNP stage Q1/Q2 and an NPN stage Q3/Q4 that are active over the different ranges of the common mode input voltage. The PNP differential pair is active between the negative supply and approximately 1.3V below the positive supply. As the input voltage moves toward the positive supply, the transistor Q5 will steer the tail current  $I_T$  to the current mirror Q6/Q7 activating the NPN differential pair. The PNP pair becomes inactive for the rest of the input common mode range up to the positive supply. Also at the input stage, devices Q18 and Q19 act to cancel the bias current of the PNP input pair. When Q1 and Q2 are active, the current in Q16 is controlled to be the same as the current in Q1 and Q2; therefore, the base current of Q16 is nominally equal to the base current of the input devices. The base current of Q16 is then mirrored by devices Q17 through Q19 to cancel the base current of the input devices Q1 and Q2.

A pair of complementary common emitter stages Q14/Q15 that enable the output to swing from rail-to-rail constructs the output stage. The capacitors C1 and C2 form the local feedback loops that lower the output impedance at high frequency. The LT1803/LT1804/LT1805 are fabricated on Linear Technology's proprietary high speed complementary bipolar process.

### Power Dissipation

There is a need to ensure that the die's junction temperature does not exceed 150°C. Junction temperature  $T_J$  is calculated from the ambient temperature  $T_A$ , power dissipation  $P_D$  and thermal resistance  $\theta_{JA}$ :

$$T_J = T_A + (P_D \cdot \theta_{JA})$$

The power dissipated in the IC is a function of the supply voltage, amplifier current, output voltage and output current. For a given supply voltage, the worst-case power dissipation,  $P_{D\text{MAX}}$ , occurs when the output current and voltage drop in the amplifier product is maximized. For example, if the amplifier is sourcing a constant current then the  $P_{D\text{MAX}}$  occurs when the output voltage is at about  $V_S^-$ . On the other hand, for a given load resistance to ground, the  $P_{D\text{MAX}}$  will occur when the output voltage is at half of either supply voltage.  $P_{D\text{MAX}}$  for a given resistance to ground is given by:

$$P_{D\text{MAX}} = (V_S^+ - V_S^-) I_{S\text{MAX}} + (V_S/2)^2/R_L$$

Example: An LT1804 in an SO-8 package operating on  $\pm 5V$  supplies and driving a 100 $\Omega$  load to ground, the  $P_{D\text{MAX}}$  per amplifier is given by:

$$P_{D\text{MAX}} = (10 \cdot 3.25\text{mA}) + (2.5)^2/100 = 0.0425 + 0.0625 = 0.095\text{W}$$

$I_{S\text{MAX}}$  is approximated for a typical part from the Supply Current vs Supply Voltage graph.

## APPLICATIONS INFORMATION



Figure 1. LT1803/LT1804/LT1805 Simplified Schematic Diagram

If both amplifiers are loaded simultaneously, then the total power dissipation is 0.19W.

The maximum ambient temperature that the part is allowed to operate is:

$$T_A = T_J - (P_{DMAX} \cdot 190^\circ\text{C/W})$$

$$= 150^\circ\text{C} - (0.190\text{W} \cdot 190^\circ\text{C/W}) = 113.9^\circ\text{C}$$

Similar calculations can be carried out for specific packages and conditions.

Also worth noting, the DD package includes a low  $\theta_{JA}$  underside metal which is internally connected to  $V_S^-$ . If the underside metal is properly soldered to a PCB, the  $\theta_{JA}$  of the part will be close to  $50^\circ\text{C/W}$ . This  $\theta_{JA}$  is significantly less than leaving the underside metal unattached and can be useful for certain applications.

### Input Offset Voltage

The input offset voltage will change greatly based upon which input stage is active. The PNP input stage is active from the negative supply voltage to about 1.3V below the positive supply rail, then the NPN input stage is activated for the remaining input range up to the positive supply rail during which the PNP stage remains inactive. The offset

voltage is typically less than  $1000\mu\text{V}$  in the range the PNP input stage is active.

### Input Bias Current

The LT1803/LT1804/LT1805 employ a patent-pending technique to reduce the input bias current to less than  $1\mu\text{A}$  for the input common mode voltage range of 0.2V above the negative supply rail to 1.75V below the positive rail. The low input offset voltage and low input bias current provide precision performance in high source impedance applications.

### Output

The LT1803/LT1804/LT1805 can deliver a large output current, so the short-circuit current limit is set around 50mA to prevent damage to the device. Attention must be paid to keep the junction temperature of the IC below the absolute maximum rating of  $150^\circ\text{C}$  (refer to the Power Dissipation section) when the output is continuously short circuited. The output of the amplifier has reverse-biased diodes connected to each supply. If the output is forced beyond either supply, unlimited current will flow through these diodes. If the current is transient and limited to less than 100mA and the total supply voltage is less than

## APPLICATIONS INFORMATION

12.6V, the absolute maximum rating, no damage will occur to the device.

### Overdrive Protection

When the input voltage exceeds the power supplies, two pairs of crossing diodes D1 through D4 will prevent the output from reversing polarity. If the input voltage exceeds either power supply by 700mV, diode D1/D2 or D3/D4 will turn on to keep the output at the proper polarity. For the phase reversal protection to perform properly, the input current must be limited to less than 10mA. If the amplifier is severely overdriven, an external resistor should be used to limit the overdrive current.

The LT1803/LT1804/LT1805's input stages are also protected against a large differential input voltage of 1.4V or higher by a pair of back-to-back diodes D5 through D8 to prevent the emitter-base breakdown of the input transistors. The current in these diodes should be limited to less than 10mA when they are active. The worst-case differential input voltage usually occurs when the input is driven while the output is shorted to ground in a unity gain configuration. In addition, the amplifier is protected against ESD strikes up to 3kV on all pins by a pair of protection diodes on each pin that is connected to the power supplies as shown in Figure 1.

### Capacitive Load

The LT1803/LT1804/LT1805 are optimized for wide bandwidth, low power and precision applications. They can drive a capacitive load of about 20pF in a unity-gain configuration, and more for higher gain. When driving a larger capacitive load, a resistor of 10 $\Omega$  to 50 $\Omega$  should be connected between the output and the capacitive load to avoid ringing or oscillation. The feedback should still be taken from the output so that the resistor will isolate the capacitive load to ensure stability. Graphs on capacitive load indicate the transient response of the amplifier when driving a capacitive load with a specified resistor.

### Feedback Components

When feedback resistors are used to set up gain, care must be taken to ensure that the pole formed by the feedback resistors and the total capacitance at the inverting input does not degrade stability. For instance, the LT1803/LT1804/LT1805 in a noninverting gain of 2 setup with two 5k resistors and a capacitance of 5pF (part plus PC board) will probably oscillate. The pole formed at 12.7MHz, reduces phase margin by about 58 degrees when the crossover frequency of the amplifier is around 20MHz. A capacitor of 5pF or higher connected across the feedback resistor will eliminate any ringing or oscillation.

# PACKAGE DESCRIPTION

**S5 Package**  
**5-Lead Plastic TSOT-23**  
 (Reference LTC DWG # 05-08-1635)

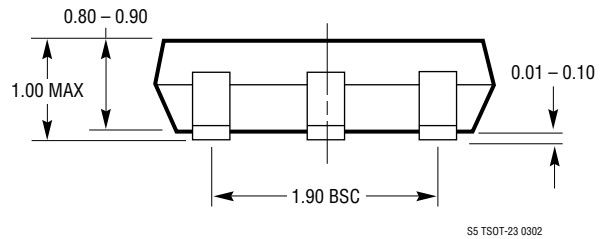
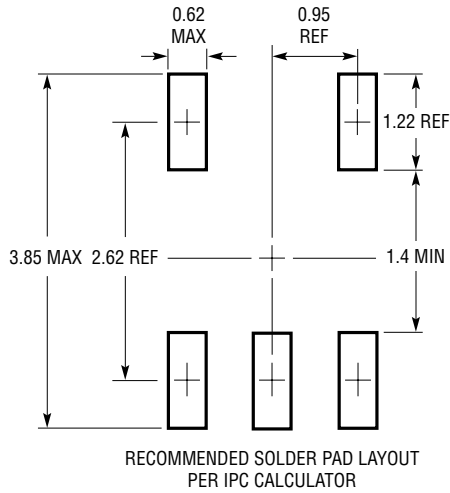

- NOTE:
1. DIMENSIONS ARE IN MILLIMETERS
  2. DRAWING NOT TO SCALE
  3. DIMENSIONS ARE INCLUSIVE OF PLATING
  4. DIMENSIONS ARE EXCLUSIVE OF MOLD FLASH AND METAL BURR
  5. MOLD FLASH SHALL NOT EXCEED 0.254mm
  6. JEDEC PACKAGE REFERENCE IS MO-193

S5 TSOT-23 0302



# PACKAGE DESCRIPTION

**DD Package**  
**8-Lead Plastic DFN (3mm × 3mm)**  
 (Reference LTC DWG # 05-08-1698)

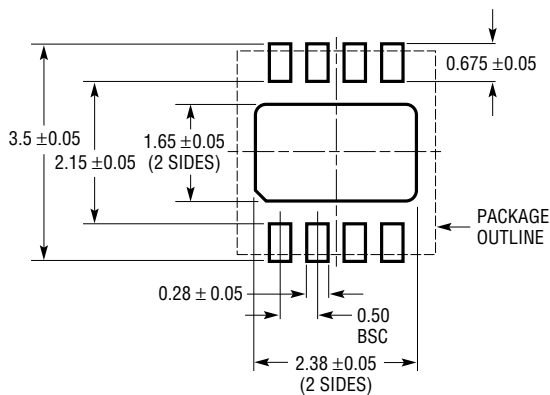

RECOMMENDED SOLDER PAD PITCH AND DIMENSIONS

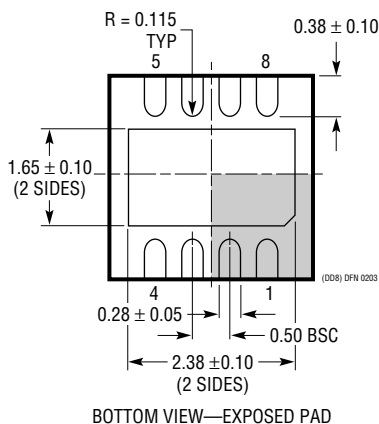
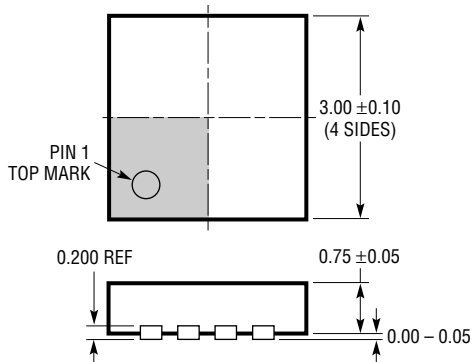

- NOTE:
1. DRAWING TO BE MADE A JEDEC PACKAGE OUTLINE MO-229 VARIATION OF (WEED-1)
  2. ALL DIMENSIONS ARE IN MILLIMETERS
  3. DIMENSIONS OF EXPOSED PAD ON BOTTOM OF PACKAGE DO NOT INCLUDE MOLD FLASH. MOLD FLASH, IF PRESENT, SHALL NOT EXCEED 0.15mm ON ANY SIDE
  4. EXPOSED PAD SHALL BE SOLDER PLATED

**PACKAGE DESCRIPTION**

**S8 Package**  
**8-Lead Plastic Small Outline (Narrow .150 Inch)**  
 (Reference LTC DWG # 05-08-1610)

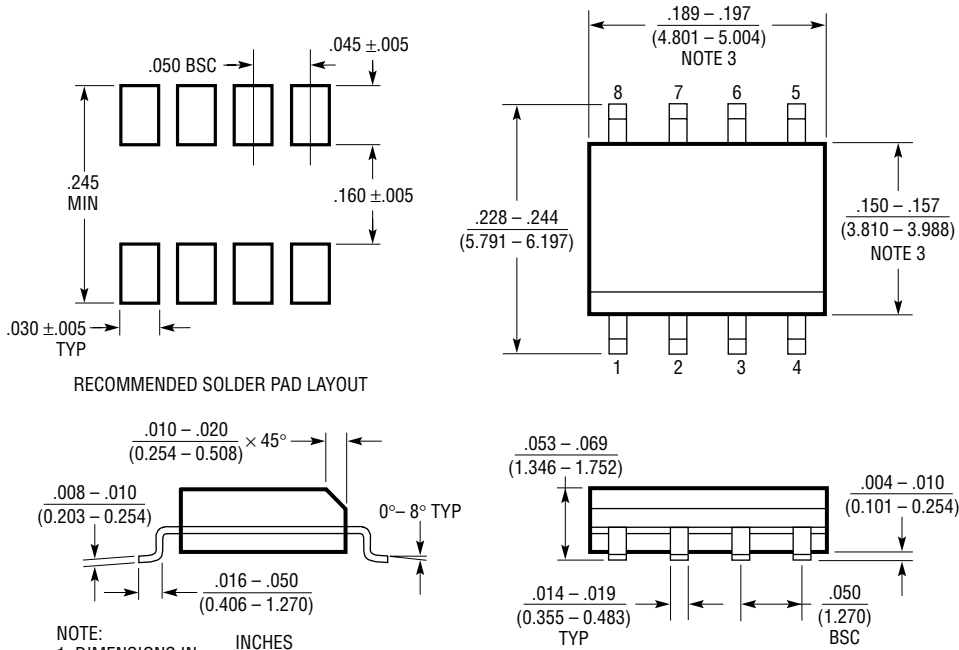

- NOTE:  
 1. DIMENSIONS IN  $\frac{\text{INCHES}}{\text{MILLIMETERS}}$   
 2. DRAWING NOT TO SCALE  
 3. THESE DIMENSIONS DO NOT INCLUDE MOLD FLASH OR PROTRUSIONS.  
 MOLD FLASH OR PROTRUSIONS SHALL NOT EXCEED  $.006"$  ( $0.15\text{mm}$ )

S08 0303

**PACKAGE DESCRIPTION**

**S Package**  
**14-Lead Plastic Small Outline (Narrow .150 Inch)**  
 (Reference LTC DWG # 05-08-1610)

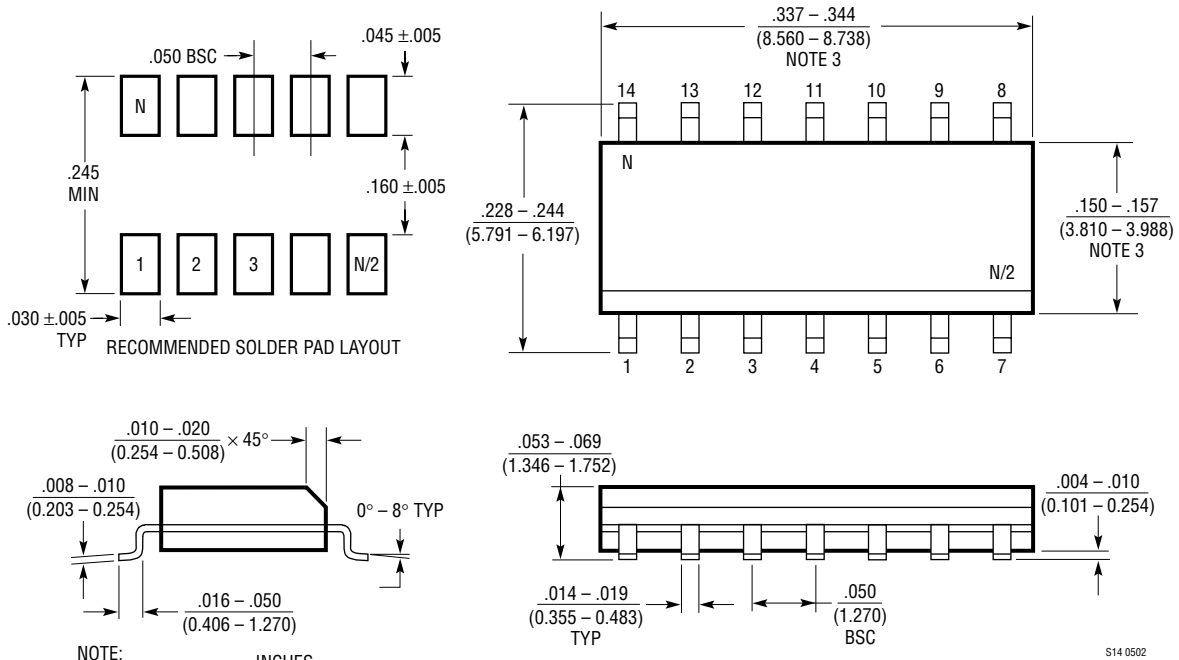

- NOTE:  
 1. DIMENSIONS IN  $\frac{\text{INCHES}}{\text{MILLIMETERS}}$   
 2. DRAWING NOT TO SCALE  
 3. THESE DIMENSIONS DO NOT INCLUDE MOLD FLASH OR PROTRUSIONS.  
 MOLD FLASH OR PROTRUSIONS SHALL NOT EXCEED .006" (0.15mm)

S14 0502

## TYPICAL APPLICATION

LED Array Driver

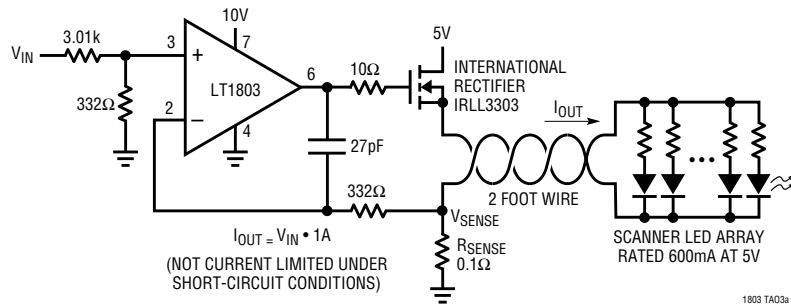

500mA Pulse Response of LED Array Driver

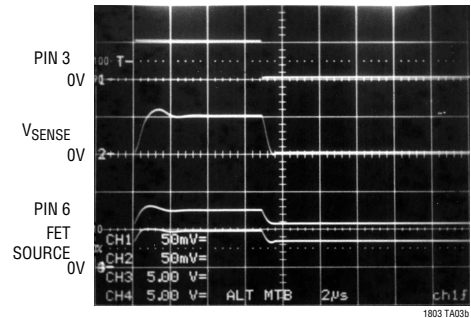

## RELATED PARTS

PART NUMBER	DESCRIPTION	COMMENTS
LT1399	Triple 300MHz Current Feedback Amplifier	0.1dB Gain Flatness to 150MHz, Shutdown
LT1498/LT1499	Dual/Quad 10MHz, 6V $\mu$ s Rail-to-Rail Input and Output C-Load™ Op Amps	High DC Accuracy, 475 $\mu$ V V <sub>OS(MAX)</sub> , 4 $\mu$ V/°C Max Drift, Max Supply Current 2.2mA per Amp
LT1630/LT1631	Dual/Quad 30MHz, 10V/ $\mu$ s Rail-to-Rail Input and Output Op Amps	High DC Accuracy, 525 $\mu$ V V <sub>OS(MAX)</sub> , 70mA Output Current, Max Supply Current 4.4mA per Amplifier
LT1800/LT1801 LT1802	Single/Dual/Quad 80MHz, 25V/ $\mu$ s Low Power Rail-to-Rail Input/Output Precision Op Amps	High DC Accuracy, 350 $\mu$ V V <sub>OS(MAX)</sub> , Max Supply Current 2mA per Amplifier
LT1806/LT1807	Single/Dual 325MHz, 140V/ $\mu$ s Rail-to-Rail Input/Output Amps	High DC Accuracy, 550 $\mu$ V V <sub>OS(MAX)</sub> , Low Noise 3.5nV/ $\sqrt{\text{Hz}}$ , Low Distortion -80dB at 5MHz, Power-Down (LT1806)
LT1809/LT1810	Single/Dual 180MHz Rail-to-Rail Input/Output Op Amps	350V/ $\mu$ s Slew Rate, Low Distortion -90dB at 5MHz, Power-Down (LT1809)
LT6200/LT6201	Single/Dual Ultralow Noise Rail-to-Rail Amplifier	0.95nV/Hz, 165MHz Gain Bandwidth, 44V/ $\mu$ s
LT6200-5	Single Ultralow Noise Rail-to-Rail Amplifier	0.95nV/Hz, 800MHz Gain Bandwidth, 210V/ $\mu$ s, A <sub>v</sub> $\geq$ 5
LT6200-10	Single Ultralow Noise Rail-to-Rail Amplifier	0.95nV/Hz, 1.6GHz Gain Bandwidth, 340V/ $\mu$ s, A <sub>v</sub> $\geq$ 10
LT6202/LT6203 LT6204	Single/Dual/Quad 90MHz, 24V/ $\mu$ s Rail-to-Rail Input/Output, Ultralow 1.9nV/ $\sqrt{\text{Hz}}$ Noise, Low Power Op Amps	High DC Accuracy, 500 $\mu$ V V <sub>OS(MAX)</sub> , Max Supply Current 3mA per Amplifier

C-Load is a trademark of Linear Technology Corporation.

## X-ON Electronics

Largest Supplier of Electrical and Electronic Components

*Click to view similar products for [High Speed Operational Amplifiers](#) category:*

*Click to view products by [Analog Devices](#) manufacturer:*

Other Similar products are found below :

[NJU7047RB1-TE2](#) [LTC6226IS8#PBF](#) [LTC6226HS8#PBF](#) [LT1058ACN](#) [LT1206CR](#) [LT1058ISW](#) [OPA2677IDDAR](#) [THS6042ID](#)  
[THS4221DBVR](#) [THS4081CD](#) [ADA4858-3ACPZ-R7](#) [LT6202IS5#TRMPBF](#) [LT1206CR#PBF](#) [LTC6253CMS8#PBF](#) [LT1813CDD#PBF](#)  
[ADA4851-4YRUZ-RL](#) [LT1037IN8#PBF](#) [LTC6401CUD-20#PBF](#) [LT1192CN8#PBF](#) [LTC6401IUD-26#PBF](#) [LT1037ACN8#PBF](#)  
[LTC6253CTS8#TRMPBF](#) [LT1399HVCS#PBF](#) [LT1993CUD-2#PBF](#) [LT1722CS8#PBF](#) [LT1208CN8#PBF](#) [LT1222CN8#PBF](#)  
[LT6203IDD#PBF](#) [LT6411IUD#PBF](#) [LTC6400CUD-26#PBF](#) [LTC6400CUD-8#PBF](#) [LT6211IDD#PBF](#) [OP27EN8#PBF](#) [LT1810IMS8#PBF](#)  
[OP37EN8#PBF](#) [LTC6253IMS8#PBF](#) [LT1360CS8](#) [OPA2132PAG4](#) [OPA2353UA/2K5](#) [OPA2691I-14D](#) [OPA4353UA/2K5](#) [OPA690IDRG4](#)  
[LMH6723MFX/NOPB](#) [ADP5302ACPZ-3-R7](#) [AD8007AKSZ-REEL7](#) [AD8008ARMZ](#) [AD8009JRTZ-REEL7](#) [AD8010ANZ](#) [AD8014ARTZ-](#)  
[REEL7](#) [AD8016AREZ](#)