

**±250V Input Range,  
100kHz, G = 10, Micropower,  
Difference Amplifier**

**FEATURES**

- **Gain = 10**
- **-3dB Bandwidth = 100kHz**
- High Common Mode Voltage Range:
  - ±250V ( $V_S = \pm 15V$ )
  - 85V Window ( $V_S = 5V, 0V$ )
- Common Mode Rejection Ratio: 60dB Min
- Input Protection to ±350V
- Gain Error: 0.8% Max
- PSRR: 82dB Min
- High Input Impedance: 2MΩ Differential, 500kΩ Common Mode
- Micropower: 180μA Max Supply Current
- Wide Supply Range: 2.7V to 36V
- Rail-to-Rail Output
- 8-pin SO and pin FMEA Compatible MSOP Packages

**APPLICATIONS**

- Battery Cell Voltage Monitoring
- High Voltage Current Sensing
- Signal Acquisition in Noisy Environments
- Input Protection
- Fault Protected Front Ends
- Level Sensing
- Isolation

**DESCRIPTION**

The **LT<sup>®</sup>1990-10** is a micropower precision difference amplifier with a very high common mode input voltage range, a fixed gain of 10 and 100kHz bandwidth. The LT1990-10 operates over a ±250V common mode voltage range on a ±15V supply. The inputs are fault protected from common mode voltage transients up to ±350V and differential voltages up to ±500V. The LT1990-10 is ideally suited for both high side and low side current or voltage monitoring.

On a single 5V supply, the LT1990-10 has an adjustable 85V input range, 60dB min CMRR and draws less than 180μA supply current. The rail-to-rail output maximizes the dynamic range, especially important for single supplies as low as 2.7V.

The LT1990-10 is specified for single 3V, 5V and ±15V supplies over the industrial temperature range.

The LT1990-10 is available in the 8-pin SO and pin FMEA compatible MSOP packages.

All registered trademarks and trademarks are the property of their respective owners.

**TYPICAL APPLICATION**

**Full-Bridge Load Current Monitor**

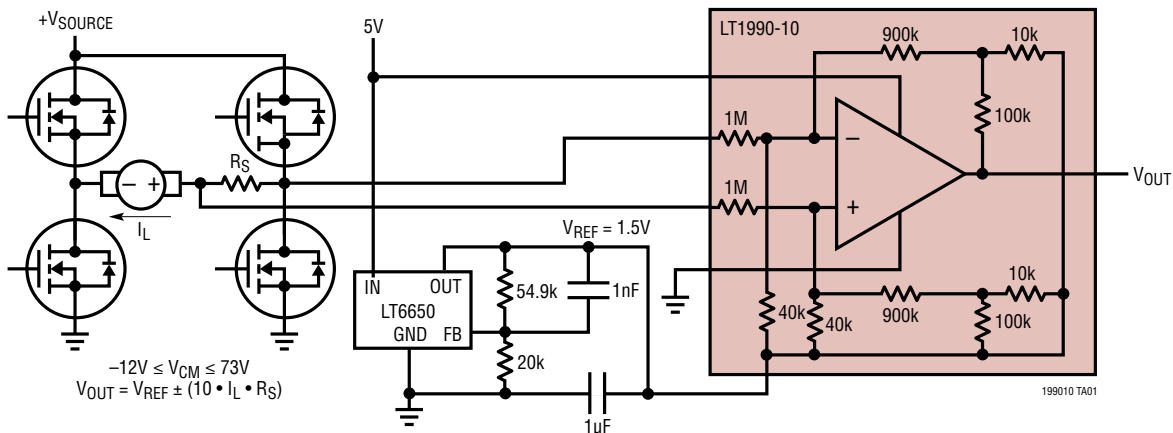

# LT1990-10

## ABSOLUTE MAXIMUM RATINGS

(Notes 1, 2)

Total Supply Voltage ( $V^+$ to $V^-$ ).....	36V	Operating Temperature Range (Note 4)	
Input Voltage Range		LT1990I-10.....	-55°C to 125°C
Each Input Continuous.....	±250V	Specified Temperature Range (Note 5)	
Each Input Transient (0.1s).....	±350V	LT1990I-10.....	-40°C to 85°C
Differential.....	±500V	Junction Temperature.....	150°C
Output Short-Circuit Duration (Note 3) .....	Indefinite	Storage Temperature Range .....	-65°C to 150°C
		Lead Temperature (Soldering, 10 sec.).....	300°C

## PIN CONFIGURATION

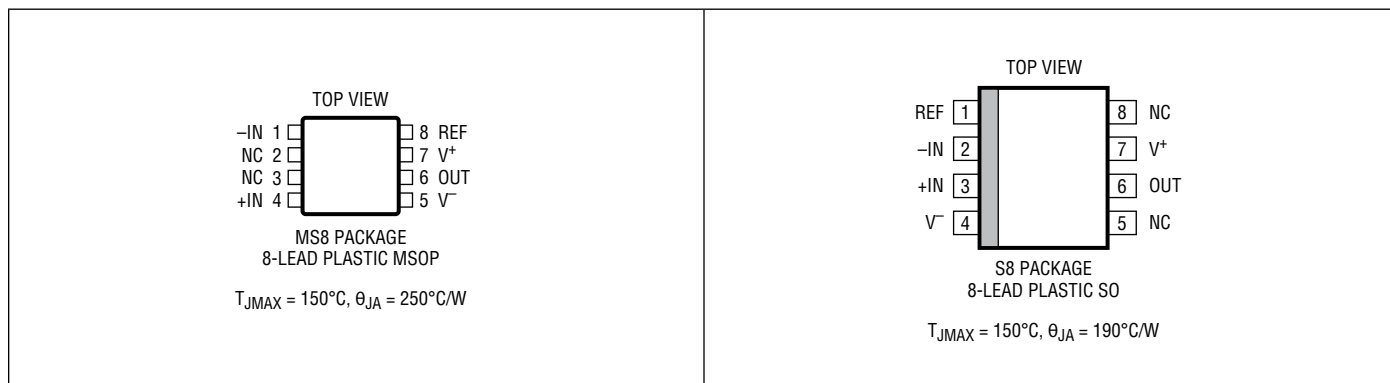

## ORDER INFORMATION

LEAD FREE FINISH	TAPE AND REEL	PART MARKING	PACKAGE DESCRIPTION	SPECIFIED TEMPERATURE RANGE
LT1990IS8-10#PBF	LT1990IS8-10#TRPBF	199010	8-Lead Plastic SO	-40°C to 85°C
LT1990IMS8-10#PBF	LT1990IMS8-10#TRPBF	LTHBQ	8-Lead Plastic MSOP	-40°C to 85°C

Consult LTC Marketing for parts specified with wider operating temperature ranges.

For more information on tape and reel specifications, go to: [Tape and reel specifications](#). Some packages are available in 500 unit reels through designated sales channels with #TRMPBF suffix.

**3V/5V ELECTRICAL CHARACTERISTICS**  $V_S = V^+, V^-; V_S = 3V, 0V; V_S = 5V, 0V; R_L = 10k\Omega, V_{CM} = V_{REF} =$   
 half supply,  $T_A = 25^\circ C$ , unless otherwise noted.

SYMBOL	PARAMETER	CONDITIONS	MIN	TYP	MAX	UNITS
G	Gain			10		
$\Delta G$	Gain Error	$V_{OUT} = 0.5V$ to $(+V_S) - 0.75V$		0.2	0.8	%
GNL	Gain Nonlinearity	$V_S = 5V, 0V; V_{OUT} = 0.5V$ to $4.25V$		0.01		%
$V_{CM}$	Input Voltage Range	Guaranteed by CMRR $V_S = 3V, 0V; V_{REF} = 1.25V$ $V_S = 5V, 0V; V_{REF} = 1.25V$ $V_S = 5V, 0V; V_{REF} = 2.5V$	-5 -5 -38		25 80 47	V V V
CMRR	Common Mode Rejection Ratio RTI (Referred to Input)	$V_S = 3V, 0V$ (Note 6) $V_{CM} = -5V$ to $25V, V_{REF} = 1.25V$	60	72		dB
		$V_S = 5V, 0V$ $V_{CM} = -5V$ to $80V, V_{REF} = 1.25V$	60	72		dB
		$V_S = 5V, 0V$ (Note 6) $V_{CM} = -38V$ to $47V, V_{REF} = 2.5V$	60	72		dB
$V_{OS}$	Offset Voltage, RTI			0.8	3	mV
	Input Noise Voltage, RTI	$f_0 = 0.1Hz$ to $10Hz$		30		$\mu V_{P-P}$
$e_n$	Noise Voltage Density, RTI	$f_0 = 1kHz$		1		$\mu V/\sqrt{Hz}$
$R_{IN}$	Input Resistance	Differential		2		$M\Omega$
		Common Mode		0.5		$M\Omega$
PSRR	Power Supply Rejection Ratio, RTI	$V_S = 2.7V$ to $12.7V, V_{CM} = V_{REF} = 1.25V$	80	92		dB
	Minimum Supply Voltage	Guaranteed by PSRR		2.4	2.7	V
$I_S$	Supply Current	(Note 7)		160	180	$\mu A$
$V_{OL}$	Output Voltage Swing LOW	$-IN = V^+, +IN =$ Half Supply (Note 7)		20	50	mV
$V_{OH}$	Output Voltage Swing HIGH	$-IN = 0V, +IN =$ Half Supply $V_S = 3V, 0V$ , Below $V^+$		80	150	mV
		$V_S = 5V, 0V$ , Below $V^+$		100	175	mV
$I_{SC}$	Output Short-Circuit Current	Short to GND (Note 8)	4	8		mA
		Short to $V^+$ (Note 8)	13	20		mA
BW	Bandwidth ( $-3dB$ )			100		kHz
SR	Slew Rate	$V_S = 5V, 0V, V_{OUT} = 0.5V$ to $4.5V$		1		$V/\mu s$
	Settling Time to 0.01%	4V Output Step, $V_S = 5V, 0V$		20		$\mu s$
$AV_{REF}$	Reference Gain to Output			$1 \pm 0.007$		

## ELECTRICAL CHARACTERISTICS

The ● denotes the specifications which apply over the temperature range of  $-40^{\circ}\text{C} \leq T_A \leq 85^{\circ}\text{C}$ .  $V_S = V_+$ ,  $V_-$ ;  $V_S = 3\text{V}, 0\text{V}$ ;  $V_S = 5\text{V}, 0\text{V}$ ;  $R_L = 10\text{k}\Omega$ ,  $V_{CM} = V_{REF} = \text{half supply}$ , unless otherwise noted. (Note 4)

SYMBOL	PARAMETER	CONDITIONS	MIN	TYP	MAX	UNITS
$\Delta G$	Gain Error	$V_{OUT} = 0.5\text{V to }(+V_S) - 0.75\text{V}$	●		0.95	%
$\Delta G/\Delta T$	Gain vs Temperature	(Note 9)	●	7	20	ppm/ $^{\circ}\text{C}$
$V_{CM}$	Input Voltage Range	Guaranteed by CMRR $V_S = 3\text{V}, 0\text{V}; V_{REF} = 1.25\text{V}$ $V_S = 5\text{V}, 0\text{V}; V_{REF} = 1.25\text{V}$ $V_S = 5\text{V}, 0\text{V}; V_{REF} = 2.5\text{V}$	● ● ●	-5 -5 -38	25 80 47	V V V
CMRR	Common Mode Rejection Ratio RTI (Referred to Input)	$V_S = 3\text{V}, 0\text{V}$ (Note 6) $V_{CM} = -5\text{V to }25\text{V}, V_{REF} = 1.25\text{V}$	●	57		dB
		$V_S = 3\text{V}, 0\text{V}$ $V_{CM} = -5\text{V to }80\text{V}, V_{REF} = 1.25\text{V}$	●	57		dB
		$V_S = 5\text{V}, 0\text{V}$ (Note 6) $V_{CM} = -38\text{V to }47\text{V}, V_{REF} = 2.5\text{V}$	●	57		dB
$V_{OS}$	Offset Voltage, RTI		●		4.5	mV
$\Delta V_{OS}/\Delta T$	Input Offset Voltage Drift, RTI	(Note 9)	●	5	22	$\mu\text{V}/^{\circ}\text{C}$
$V_{OSH}$	Input Offset Voltage Hysteresis, RTI	(Note 10)	●	230		$\mu\text{V}$
PSRR	Power Supply Rejection Ratio, RTI	$V_S = 2.7\text{V to }12.7\text{V}, V_{CM} = V_{REF} = 1.25\text{V}$	●	76		dB
	Minimum Supply Voltage	Guaranteed by PSRR	●		2.7	V
$I_S$	Supply Current	(Note 7)	●		250	$\mu\text{A}$
$V_{OL}$	Output Voltage Swing LOW	$-IN = V^+, +IN = \text{Half Supply}$ (Note 7)	●		70	mV
$V_{OH}$	Output Voltage Swing HIGH	$-IN = 0\text{V}, +IN = \text{Half Supply}$ $V_S = 3\text{V}, 0\text{V}$ , Below $V^+$	●		200	mV
		$V_S = 5\text{V}, 0\text{V}$ , Below $V^+$	●		225	mV
$I_{SC}$	Output Short-Circuit Current	Short to GND (Note 8)	●	2		mA
		Short to $V^+$ (Note 8)	●	8		mA

**±15V ELECTRICAL CHARACTERISTICS**  $V_S = \pm 15V$ ,  $R_L = 10k\Omega$ ,  $V_{CM} = V_{REF} = 0V$ ,  $T_A = 25^\circ C$ , unless otherwise noted.

SYMBOL	PARAMETER	CONDITIONS	MIN	TYP	MAX	UNITS
G	Gain			10		
$\Delta G$	Gain Error	$V_{OUT} = \pm 10V$		0.2	0.8	%
GNL	Gain Nonlinearity	$V_{OUT} = \pm 10V$		0.005	0.02	%
$V_{CM}$	Input Voltage Range	Guaranteed by CMRR	-250		250	V
CMRR	Common Mode Rejection Ratio, RTI	$V_{CM} = -250V$ to $250V$	60	72		dB
$V_{OS}$	Offset Voltage, RTI			0.9	5.2	mV
	Input Noise Voltage, RTI	$f_0 = 0.1Hz$ to $10Hz$		30		$\mu V_{P-P}$
$e_n$	Noise Voltage Density, RTI	$f_0 = 1kHz$		1		$\mu V/\sqrt{Hz}$
$R_{IN}$	Input Resistance	Differential Common Mode		2 0.5		$M\Omega$ $M\Omega$
PSRR	Power Supply Rejection Ratio, RTI	$V_S = \pm 1.35V$ to $\pm 18V$ , $V_{CM} = V_{REF} = 1.25V$	82	100		dB
	Minimum Supply Voltage	Guaranteed by PSRR		$\pm 1.2$	$\pm 1.35$	V
$I_S$	Supply Current			200	275	$\mu A$
$V_{OUT}$	Output Voltage Swing		$\pm 14.5$	$\pm 14.75$		V
$I_{SC}$	Output Short-Circuit Current	Short to $V^-$ Short to $V^+$	6 15	9 22		mA mA
BW	Bandwidth (-3dB)			110		kHz
SR	Slew Rate	$V_{OUT} = \pm 10V$ , No $R_L$	0.8	1.2		V/ $\mu s$
	Settling Time to 0.01%	10V Output Step		25		$\mu s$
$AV_{REF}$	Reference Gain to Output			$1 \pm 0.007$		

## ELECTRICAL CHARACTERISTICS

The ● denotes the specifications which apply over the temperature range of  $-40^{\circ}\text{C} \leq T_A \leq 85^{\circ}\text{C}$ .  $V_S = \pm 15\text{V}$ ,  $R_L = 10\text{k}\Omega$ ,  $V_{\text{CM}} = V_{\text{REF}} = 0\text{V}$ , unless otherwise noted. (Note 4)

SYMBOL	PARAMETER	CONDITIONS	MIN	TYP	MAX	UNITS
$\Delta G$	Gain Error	$V_{\text{OUT}} = \pm 10\text{V}$	●		0.95	%
GNL	Gain Nonlinearity	$V_{\text{OUT}} = \pm 10\text{V}$	●		0.03	%
$\Delta G/\Delta T$	Gain vs Temperature	(Note 9)	●	7	20	ppm/ $^{\circ}\text{C}$
$V_{\text{CM}}$	Input Voltage Range	Guaranteed by CMRR	●	-250	250	V
CMRR	Common Mode Rejection Ratio, RTI	$V_{\text{CM}} = -250\text{V}$ to $250\text{V}$	●	58		dB
$V_{\text{OS}}$	Offset Voltage, RTI		●		6.7	mV
$\Delta V_{\text{OS}}/\Delta T$	Input Offset Voltage Drift, RTI	(Note 9)	●	5	22	$\mu\text{V}/^{\circ}\text{C}$
$V_{\text{OSH}}$	Input Offset Voltage Hysteresis, RTI	(Note 10)	●	250		$\mu\text{V}$
PSRR	Power Supply Rejection Ratio, RTI	$V_S = \pm 1.35\text{V}$ to $\pm 18\text{V}$ , $V_{\text{CM}} = V_{\text{REF}} = 1.25\text{V}$	●	78		dB
	Minimum Supply Voltage	Guaranteed by PSRR	●		$\pm 1.35$	V
$I_S$	Supply Current		●		375	$\mu\text{A}$
$V_{\text{OUT}}$	Output Voltage Swing		●	$\pm 14.3$		V
$I_{\text{SC}}$	Output Short-Circuit Current	Short to $V^-$ Short to $V^+$	● ●	3 10		 mA mA
SR	Slew Rate	$V_{\text{OUT}} = \pm 10\text{V}$ , No $R_L$	●	0.4		V/ $\mu\text{s}$

**Note 1:** Stresses beyond those listed under Absolute Maximum Ratings may cause permanent damage to the device. Exposure to any Absolute Maximum Rating condition for extended periods may affect device reliability and lifetime.

**Note 2:** ESD (Electrostatic Discharge) sensitive device. Extensive use of ESD protection devices are used internal to the LT1990-10, however, high electrostatic discharge can damage or degrade the device. Use proper ESD handling precautions.

**Note 3:** A heat sink may be required to keep the junction temperature below absolute maximum.

**Note 4:** The LT1990I-10 is designed, characterized and expected to be functional over the operating temperature range of  $-55^{\circ}\text{C}$  to  $125^{\circ}\text{C}$ , but is not tested or QA sampled at these temperatures.

**Note 5:** The LT1990I-10 is guaranteed to meet specified performance from  $-40^{\circ}\text{C}$  to  $85^{\circ}\text{C}$ .

**Note 6:** Limits are guaranteed by correlation to  $-5\text{V}$  to  $80\text{V}$  CMRR tests.

**Note 7:**  $V_S = 3\text{V}$  limits are guaranteed by correlation to  $V_S = 5\text{V}$  and  $V_S = \pm 15\text{V}$  tests.

**Note 8:**  $V_S = 5\text{V}$  limits are guaranteed by correlation to  $V_S = 3\text{V}$  and  $V_S = \pm 15\text{V}$  tests.

**Note 9:** This parameter is not 100% tested.

**Note 10:** Hysteresis in offset voltage is created by package stress that differs depending on whether the IC was previously at a higher or lower temperature. Offset voltage hysteresis is always measured at  $25^{\circ}\text{C}$ , but the IC is cycled to  $85^{\circ}\text{C}$  or  $-40^{\circ}\text{C}$  before successive measurement.

# TYPICAL PERFORMANCE CHARACTERISTICS

**Supply Current vs Supply Voltage**

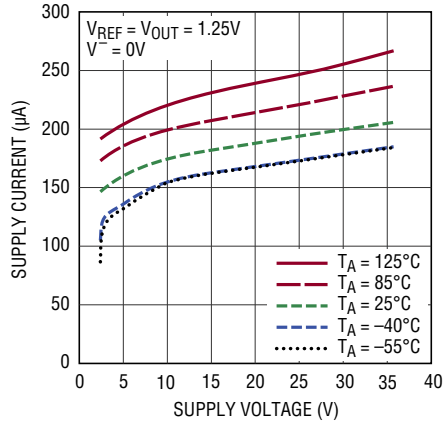

1990 G01

**Supply Current vs Temperature**

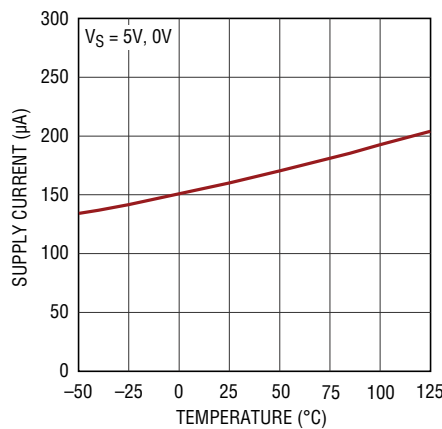

1990 G02

**Output Voltage Swing vs Load Current (Source)**

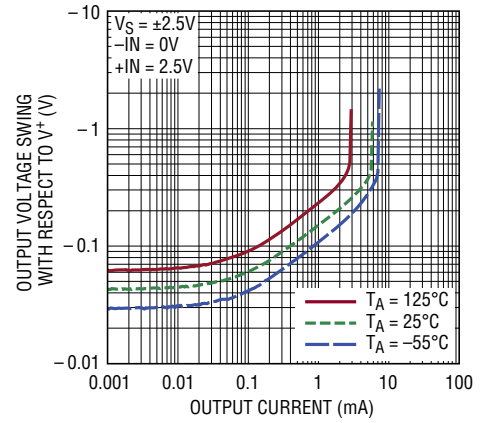

1990 G03

**Output Voltage Swing vs Load Current (Sink)**

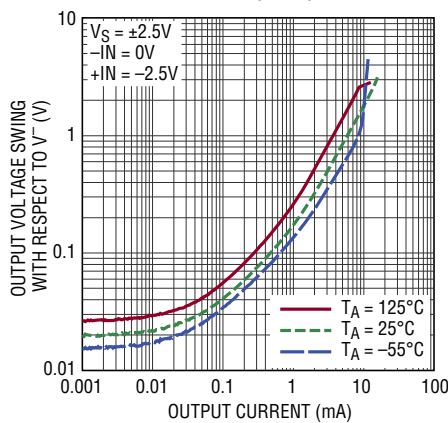

1990 G04

**Output Voltage Swing vs Input Voltage (High)**

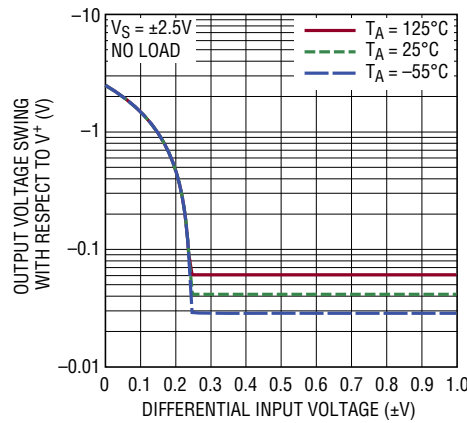

1990 G05

**Output Voltage Swing vs Input Voltage (Low)**

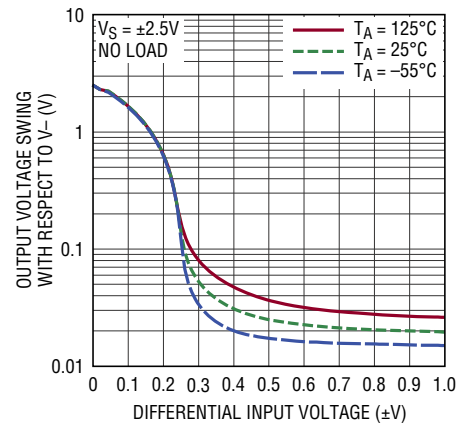

1990 G06

**Output Voltage Swing vs Supply Voltage (High)**

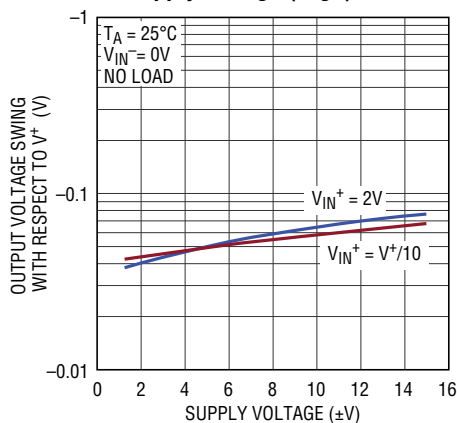

1990 G07

**Output Voltage Swing vs Supply Voltage (Low)**

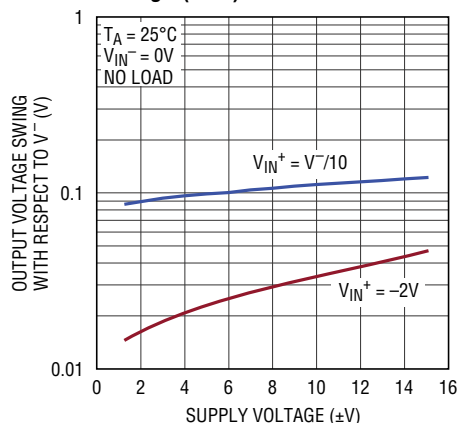

1990 G08

**Output Short-Circuit Current vs Supply Voltage**

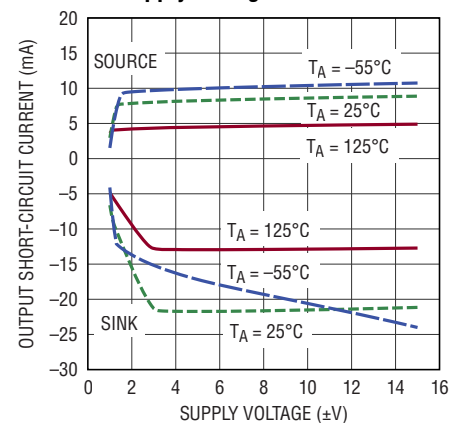

199010 G09

# TYPICAL PERFORMANCE CHARACTERISTICS

**Input Voltage Range vs Single Supply Voltage**

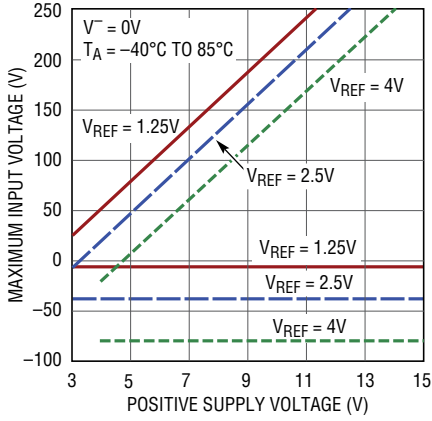

1990 G10

**Input Voltage Range vs Split Supply Voltage**

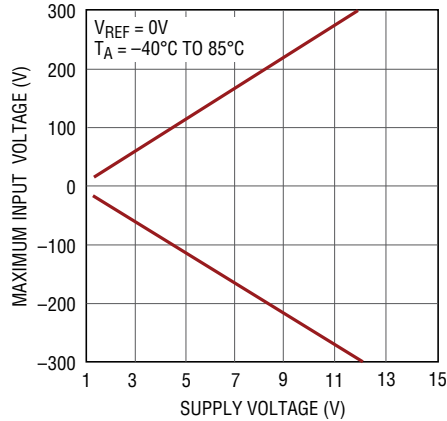

1990 G11

**Common Mode Rejection Ratio vs Frequency**

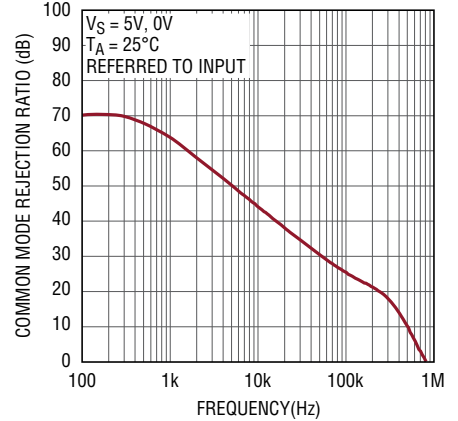

1990 G12

**Gain vs Frequency**

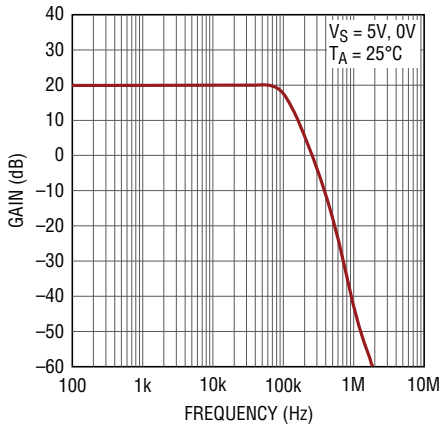

1990 G13

**-3dB Bandwidth vs Supply Voltage**

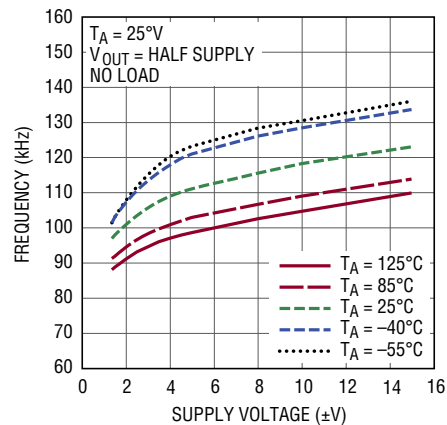

1990 G14

**Slew Rate vs Supply Voltage**

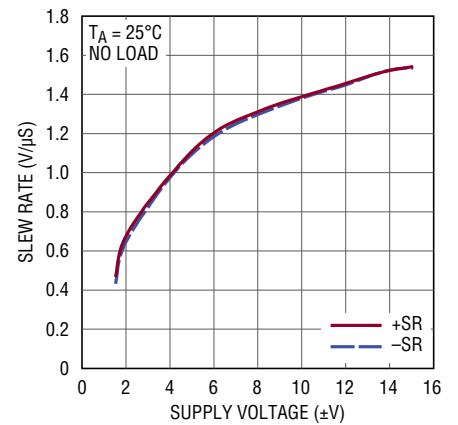

1990 G15

**Slew Rate vs Temperature**

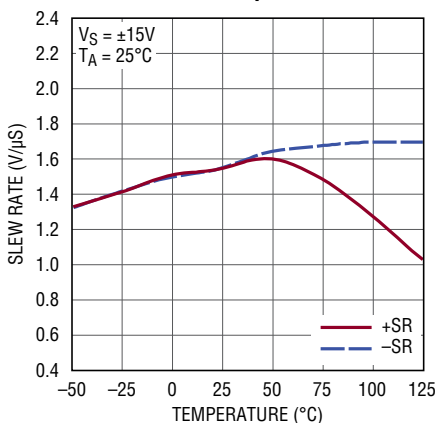

1990 G16

**Output Impedance vs Frequency**

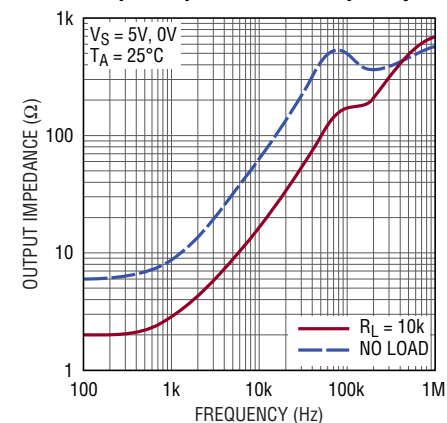

1990 G17

**Power Supply Rejection Ratio vs Frequency**

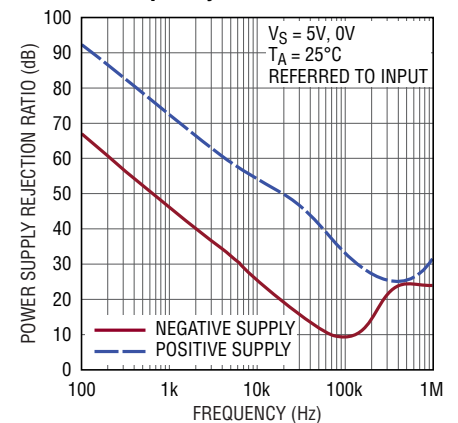

1990 G18



# TYPICAL PERFORMANCE CHARACTERISTICS

**Warm-up Drift**

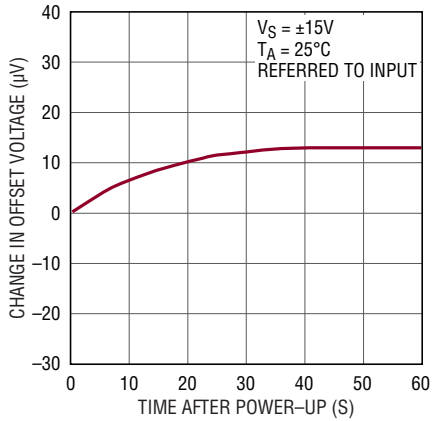

1990 G19

**Settling Time vs Output Step**

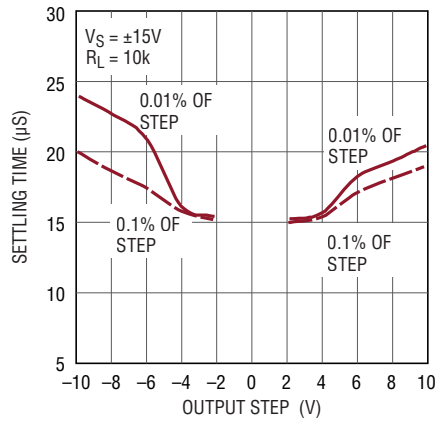

1990 G20

**Voltage Noise Density vs Frequency**

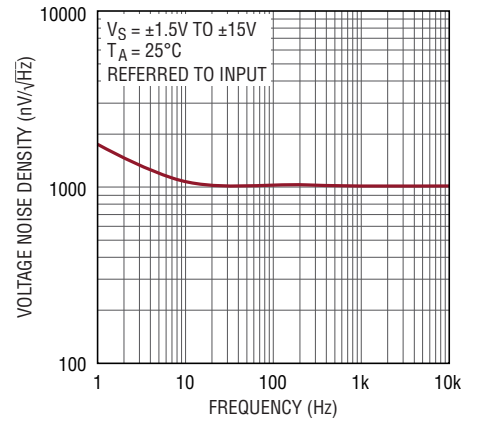

1990 G21

**0.1Hz to 10Hz Noise Voltage**

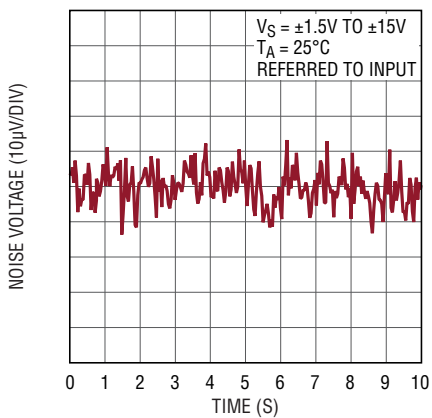

1990 G22

**0.01Hz to 1Hz Noise Voltage**

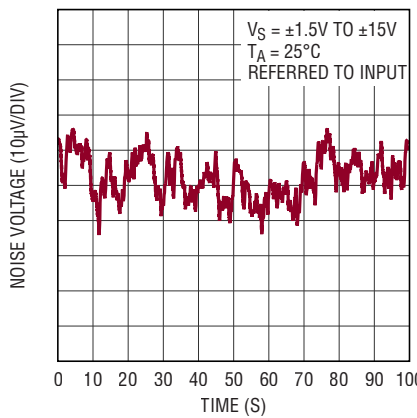

199010 G23

**Overshoot vs Capacitive Load**

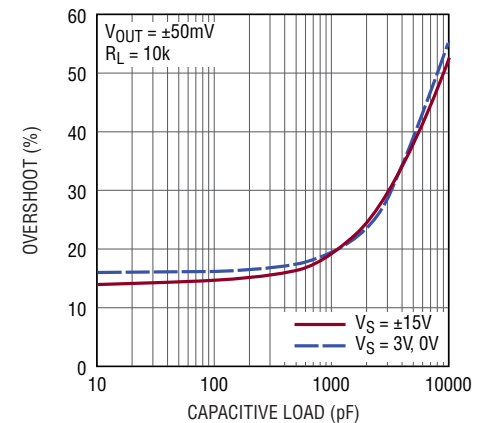

1990 G24

**Instability with Output Saturated to V+**

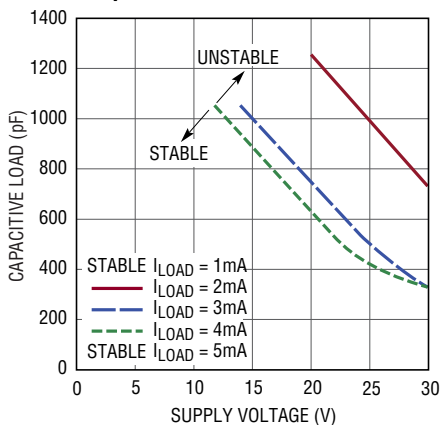

1990 G25

**Small Signal Transient Response**

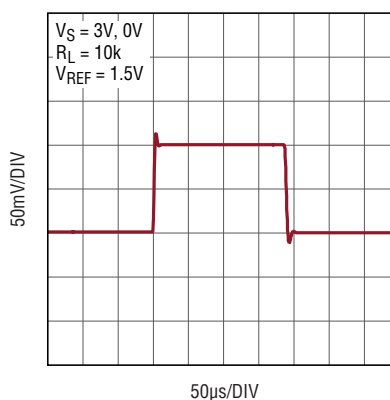

1990 G26

**Small Signal Transient Response**

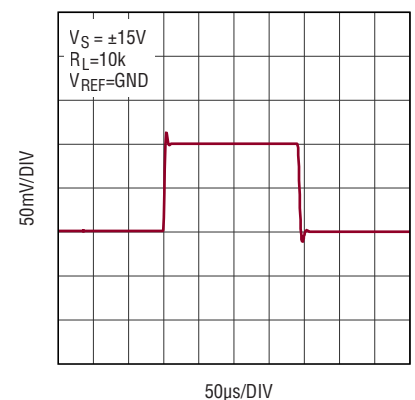

199010 G27

## TYPICAL PERFORMANCE CHARACTERISTICS

Large Signal Transient Response

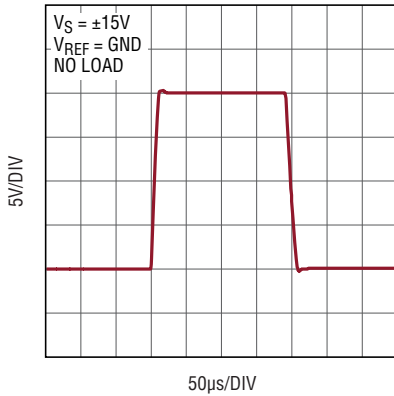

Large Signal Transient Response

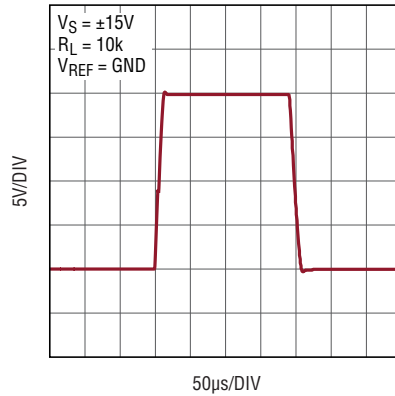

Input Common Mode Voltage Transient Response

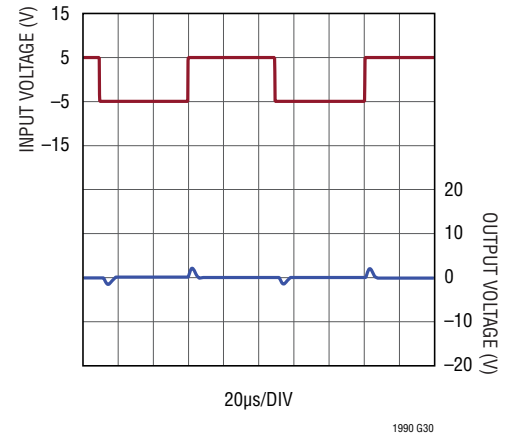

## PIN FUNCTIONS

**REF:** Reference Input. Sets the output level when the difference between the inputs is zero.

**-IN:** Inverting Input. Connects a 1MΩ resistor divider to the op amp's inverting input. Designed to permit high voltage operation.

**+IN:** Noninverting Input. Connects a 1MΩ resistor divider to the op amp's noninverting input. Designed to permit high voltage operation.

**V<sup>-</sup>:** Negative Power Supply. Can be either ground (in single supply applications) or a negative voltage (in split supply applications).

**NC:** Not internally connected. May be tied to any pin or floated.

**OUT:** Output.  $V_{OUT} = 10 \cdot (V_{+IN} - V_{-IN}) + V_{REF}$ .

**V<sup>+</sup>:** Positive Power Supply. Can range from 2.7V to 36V above the V<sup>-</sup> voltage.

**BLOCK DIAGRAM**

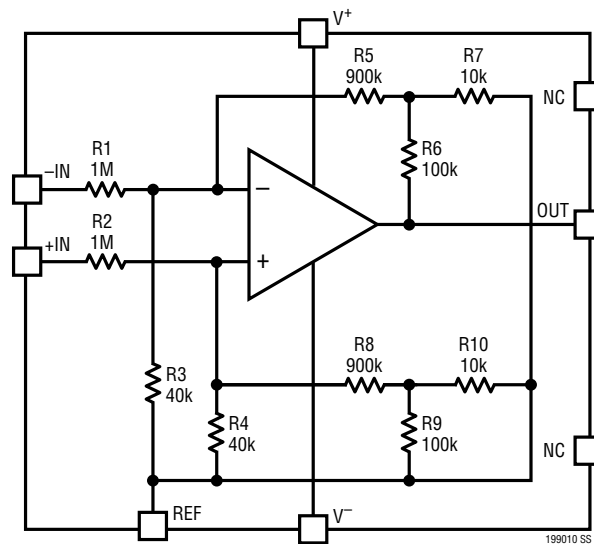

## APPLICATIONS INFORMATION

### Primary Features

The LT1990-10 is a complete gain-block solution for high input common mode voltage applications. The part combines a low-power precision operational amplifier with thin-film resistors trimmed to produce a gain of 10 with high accuracy. The Block Diagram shows the internal architecture of the part. The on-chip resistors form a modified difference-amplifier including a reference port for introducing offset or other additive waveforms. The resistor network is structured to produce internal common mode voltage division of 27, enabling a very large input range. The input range can far exceed the power supply voltage(s) used by the LT1990-10 itself. Standard ESD clamp diodes are included on all the I/O except the  $-IN$  and  $+IN$  pins. The inputs are rated to  $\pm 250V$  and protected to  $\pm 500V$ . The LT1990-10 is ideally suited to situations where relatively small signals need to be extracted from high voltage circuits, as is the case in many instrumentation applications. With its wide input voltage range and greater than 1 megohm input impedances, development of instrumentation designs is greatly simplified with the LT1990-10 single-chip solution over conventional discrete methods.

### Classic Difference Amplifier

The basic gain of ten difference amplifier topology has the following dc transfer function:

$$V_O = 10 \cdot (V_{+IN} - V_{-IN}) + V_{REF}$$

By including the internal common mode division by 27, the input common mode range capability is extended up to  $\pm 250V$  according to the following relationships:

$$V_{CM+} \leq 27 \cdot V^+ - 26 \cdot V_{REF} - 23$$

$$V_{CM-} \geq 27 \cdot V^- - 26 \cdot V_{REF} + 27$$

For split supplies over about  $\pm 11V$ , the full  $\pm 250V$  common mode range is normally available (with  $V_{REF}$  a small fraction of the supply). With lower supply voltages, an appropriate selection of  $V_{REF}$  can tailor the input common mode range to a specific requirement. For single supply circuits,  $V_{REF}$  should be greater than  $V^-$  to allow bidirectional output swing and to keep the inputs of the internal op amp within their operating region. Note: the differential input voltage range is reduced as  $V_{CM}$  approaches its limits. The following low supply-voltage scenarios are readily implemented with the LT1990-10:

**Table 1.**

Supply	$V_{REF}$	$V_{CM}$ Range
3V	1.25V	-5V to 25V (e.g. 12V Automotive Environment)
5V	1.25V	-5V to 80V (e.g. 42V Automotive Environment)
5V	4.00V	-77V to 8V (e.g. Telecom Environment; Use Downward Signaling)

### Preserving and Enhancing Common Mode Rejection

The basic difference amplifier topology of the LT1990-10 is sensitive to the external resistances of circuits driving the part. To preserve the high accuracy of the LT1990-10, the source impedance of any signal connected to the REF pin must be on the order of a few ohms or less, such as from a Reference or op-amp output. The difference inputs have nominal 1 megohm internal resistances that are matched to within a few hundred ohms, so source resistances should also be kept low to maximize accuracy and CMRR.

While every LT1990-10 is factory trimmed, some precision applications with a large applied common mode voltage may benefit from a trim method to further minimize common mode error. This is easily accomplished as shown in Figure 1. A series resistance is added to each input: a fixed  $1k\Omega$  in series with one of the inputs and a  $2k\Omega$  trimmer

## APPLICATIONS INFORMATION

in series with the other. The trim range of this configuration is  $\pm 0.1\%$  for the internal input resistor matching. This technique using the LT1990-10 offers a much more finely resolved correction than is available from ordinary discrete solutions. In applications where the common mode is relatively constant and large, this same configuration can be treated as an offset adjustment.

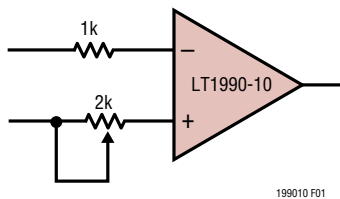

**Figure 1. Optional CMRR Trim**

### Output Stability with Capacitive Loads

The LT1990-10 is internally compensated to drive high capacitive loads of at least 2nF under all output loading conditions when the output is in its linear region or saturated to  $V^-$ . However, a small oscillation may occur if the output is saturated to  $V^+$  with capacitive loads greater than 300pF at higher load currents and higher supply voltages. A 10nF capacitor in series with a 600 $\Omega$  resistor placed between the output and ground will compensate the amplifier for capacitive loads up to 10nF at all output loading conditions. See the region of instability in the Typical Performance Characteristics section.

**PACKAGE DESCRIPTION**

**MS8 Package**  
**8-Lead Plastic MSOP**  
 (Reference LTC DWG # 05-08-1660 Rev G)

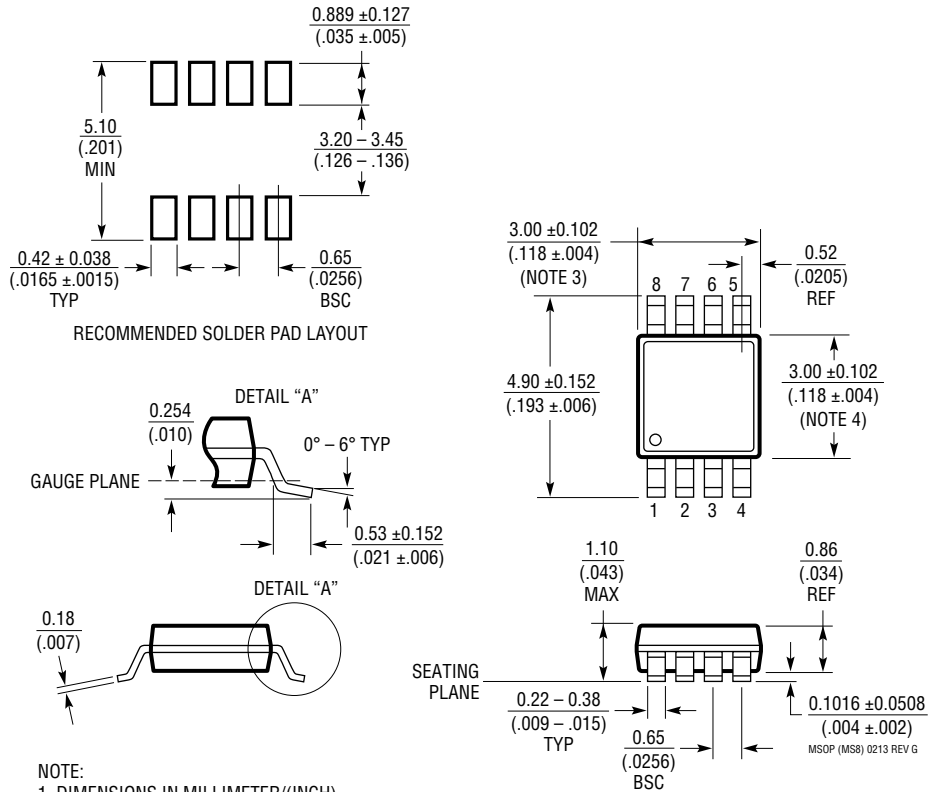

- NOTE:
1. DIMENSIONS IN MILLIMETER/(INCH)
  2. DRAWING NOT TO SCALE
  3. DIMENSION DOES NOT INCLUDE MOLD FLASH, PROTRUSIONS OR GATE BURRS.  
MOLD FLASH, PROTRUSIONS OR GATE BURRS SHALL NOT EXCEED 0.152mm (.006") PER SIDE
  4. DIMENSION DOES NOT INCLUDE INTERLEAD FLASH OR PROTRUSIONS.  
INTERLEAD FLASH OR PROTRUSIONS SHALL NOT EXCEED 0.152mm (.006") PER SIDE
  5. LEAD COPLANARITY (BOTTOM OF LEADS AFTER FORMING) SHALL BE 0.102mm (.004") MAX

# PACKAGE DESCRIPTION

## S8 Package 8-Lead Plastic Small Outline (Narrow .150 Inch) (Reference LTC DWG # 05-08-1610 Rev G)

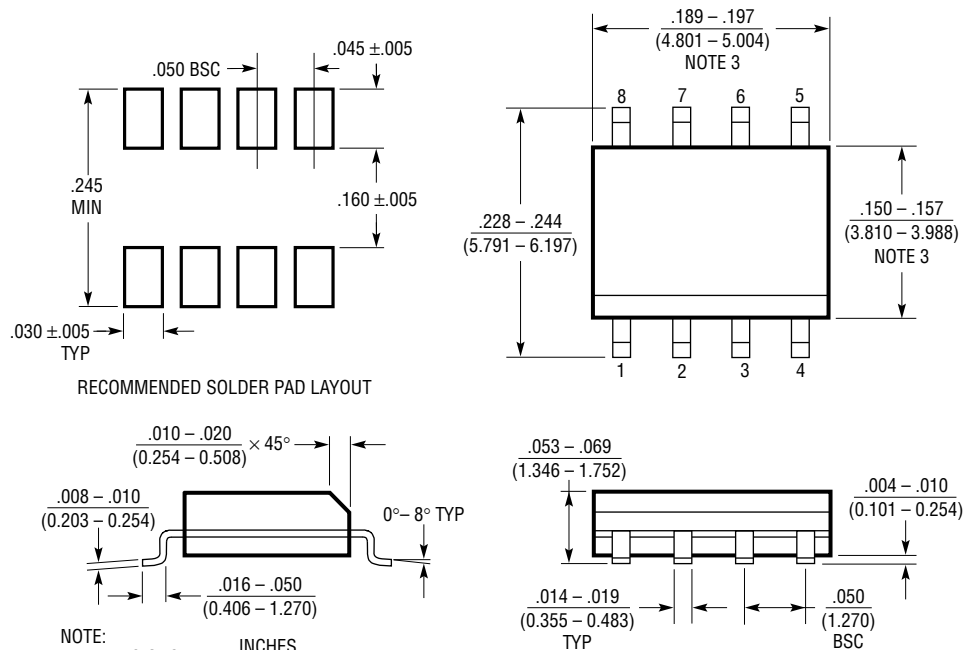

- NOTE:
1. DIMENSIONS IN  $\frac{\text{INCHES}}{\text{MILLIMETERS}}$
  2. DRAWING NOT TO SCALE
  3. THESE DIMENSIONS DO NOT INCLUDE MOLD FLASH OR PROTRUSIONS. MOLD FLASH OR PROTRUSIONS SHALL NOT EXCEED  $.006"$  ( $0.15\text{mm}$ )
  4. PIN 1 CAN BE BEVEL EDGE OR A DIMPLE

S08 REV G 0212

## TYPICAL APPLICATIONS

### Telecom Supply Current Monitor

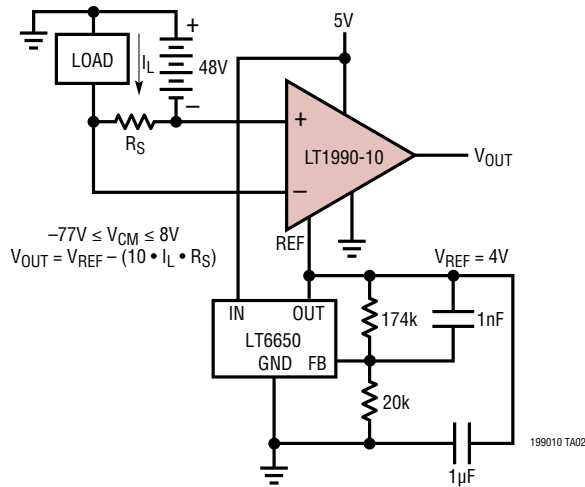

### Boosted Bidirectional Controlled Current Source

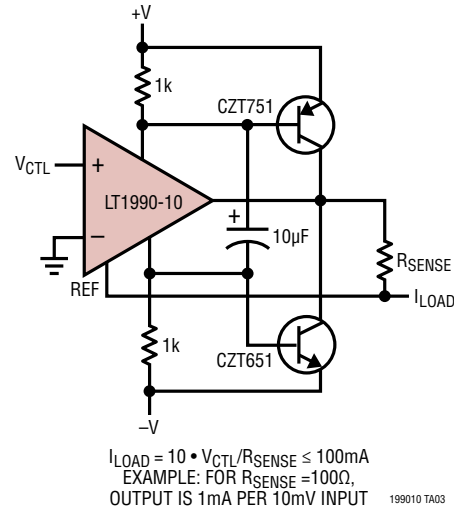

### Bidirectional Controlled Current Source

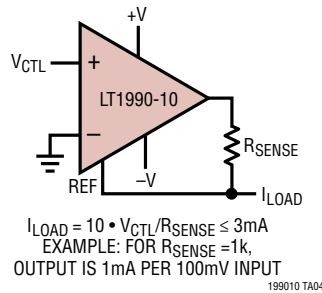

## RELATED PARTS

PART NUMBER	DESCRIPTION	COMMENTS
<a href="#">LT1787</a>	Precision High Side Current Sense Amplifier	On-Chip Precision Resistor Array
<a href="#">LT1789</a>	Micropower Instrumentation Amplifier	Micropower, Precision, $G = 1$ to 1000
<a href="#">LTC1921</a>	Dual $-48V$ Supply and Fuse Monitor	Withstands $\pm 200V$ Transients
<a href="#">LT1990</a>	$\pm 250V$ Input Range Difference Amplifier	Micropower, Precision, Pin Selectable $G = 1$ or 10
<a href="#">LT1991</a>	High Accuracy Difference Amplifier	Micropower, Precision, Pin Selectable $G = -13$ to 14
<a href="#">LT1995</a>	30MHz, 1000V/ $\mu s$ Gain Selectable Amplifier	Pin Selectable $G = -7$ to 8
<a href="#">LTC6910</a>	Single Supply Programmable Gain Amplifier	Digitally Controlled, SOT-23, $G = 0$ to 100
<a href="#">LT1997-3</a>	Wide Voltage Range Gain Selectable Amplifier	$\pm 160V$ Input Voltage Range, Pin Selectable $G = -13$ to 14
<a href="#">LT6375</a>	$\pm 270V$ Common Mode Voltage Difference Amplifier	97dB Minimum CMRR, Over the Top Protected Inputs
<a href="#">LT6376</a>	$\pm 230V$ Common Mode Voltage Difference Amplifier $G = 10$	90dB Minimum CMRR, Over the Top Protected Inputs
<a href="#">LT1999-X</a>	High Voltage, Bidirectional Current Sense Amplifier	Three Gain Options, $-5V$ to $80V$ Input Common Mode Voltage Range



## X-ON Electronics

Largest Supplier of Electrical and Electronic Components

*Click to view similar products for [Differential Amplifiers](#) category:*

*Click to view products by [Analog Devices](#) manufacturer:*

Other Similar products are found below :

[LT6604IUUFF-2.5#PBF](#) [INA149AMDREP](#) [LT6600CS8-15#PBF](#) [LT6604IUUFF-15#PBF](#) [LT6604CUFF-5#PBF](#) [THS4552IRTWT](#) [LTC1992-2IMS8#PBF](#) [AD8138SRMZ-EP-R7](#) [LT6376IMS#PBF](#) [AD626ANZ](#) [AD626BNZ](#) [AD629ANZ](#) [AD629BNZ](#) [AD8129ARMZ](#) [AD8131ARMZ-REEL7](#) [AD8137WYCPZ-R7](#) [AD8138AARZ](#) [AD8138ARMZ](#) [AD8139ACPZ-REEL7](#) [AD8139ARDZ](#) [AD8139ARDZ-REEL7](#) [AD8202WYRMZ](#) [AD8203YRMZ](#) [AD8208WBRMZ](#) [AD8209AWBRMZ](#) [AD8209WBRMZ](#) [AD8209WHRMZ](#) [AD8274ARMZ](#) [AD8278ARMZ](#) [AD8278ARMZ-R7](#) [AD8278BRMZ-R7](#) [AD830ANZ](#) [AD8350ARMZ15](#) [AD8350ARMZ20](#) [AD8366ACPZ-R7](#) [AD8475BRMZ](#) [AD8476ACPZ-R7](#) [AD8476ARMZ-R7](#) [AD8476BCPZ-R7](#) [AD8476BCPZ-WP](#) [AD8147ACPZ-R2](#) [ADA4930-2YCPZ-R2](#) [ADA4938-2ACPZ-R7](#) [ADA4939-2YCPZ-R7](#) [AD8133ACPZ-R2](#) [AD8133ACPZ-REEL7](#) [AD8148ACPZ-R7](#) [ADA4930-2YCPZ-R7](#) [ADA4932-2YCPZ-R2](#) [ADA4937-2YCPZ-R7](#)