

FEATURES

- *Guaranteed* 1% Initial Tolerance of Output Voltage
- 3 Amp Output Current
- 30 Watt
- Full Internal Overload Protection
- 100% Burn-in in Thermal Limit

APPLICATIONS

- Local 5V Regulators
- On Card Regulation
- Lab Supplies
- Instrumentation Supplies

DESCRIPTION

The LT123A/LT323A is an improved version of the popular LM123/LM323 5 Volt, 3 Amp Regulator. These new devices offer maximum initial output voltage tolerance of 1% and maintain a maximum tolerance of 3% over worst case operating conditions. Line and load regulation are also improved by a factor of 2. These tightened specifications ease design and application problems since safety margins are improved. Also, error budgets in other parts of the system can be expanded, and output voltages at the end of long supply runs can be more accurately maintained.

The LT123A/LT323A incorporates Linear Technology's advanced design, process and test techniques for improved quality and reliability over similar device types. Specifically, all devices are burned in by shorting the output, thereby forcing the regulator into its current limit and eventually, thermal limit. This ensures that all device protection features are functional. A graph of the worst case output voltage, taking into account temperature, load and line variations, and power dissipation is shown below. For higher output current requirements, see the LT1003, 5V, 5A regulator data sheet.

4

Precision 5 Volt Regulator

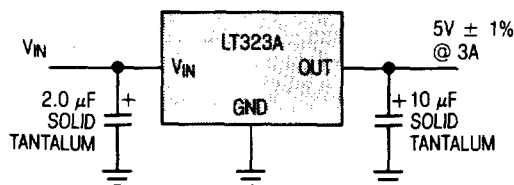

Worst Case Output Voltage

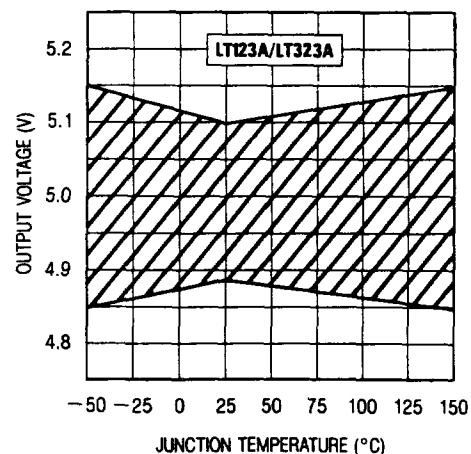

ABSOLUTE MAXIMUM RATINGS

Input Voltage	20 Volts
Power Dissipation	Internally Limited
Operating Junction Temperature Range	
LT123A/LM123	−55°C to 150°C
LT323A/LM323	0°C to 125°C
Storage Temperature Range	
LT123A/LM123	−65°C to 150°C
LT323A/LM323	−65°C to 150°C
Lead Temperature (Soldering, 10 sec.)	300°C

PACKAGE/ORDER INFORMATION

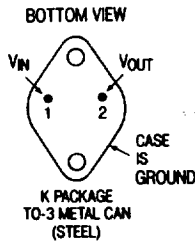
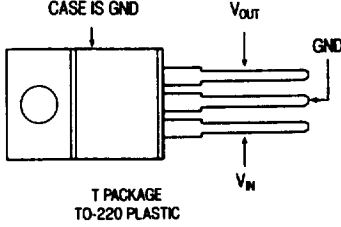
 <p>BOTTOM VIEW K PACKAGE TO-3 METAL CAN (STEEL)</p>	ORDER PART NO.
	LT123AK
	LT323AK
	LM123K LM323K
 <p>T PACKAGE TO-220 PLASTIC</p>	LT323AT LM323T

PRECONDITIONING:

Thermal limit burn-in for all devices.

ELECTRICAL CHARACTERISTICS (See Note 1)

SYMBOL	PARAMETER	CONDITIONS	LT123A			LM123			UNITS
			MIN	TYP	MAX	MIN	TYP	MAX	
V_{OUT}	Output Voltage	$T_J = 25^\circ\text{C}, V_{IN} = 7.5\text{V}, I_{OUT} = 0$	4.95	5.0	5.05	4.7	5.0	5.3	V
		$7.5\text{V} \leq V_{IN} \leq 15\text{V}, T_{MIN} \leq T_J \leq T_{MAX}$ $0 \leq I_{OUT} \leq 3\text{A}, P \leq 30\text{W}$	● 4.85	5.0	5.15	4.6		5.4	V
$\frac{\Delta V_{OUT}}{\Delta V_{IN}}$	Line Regulation	$T_J = 25^\circ\text{C}, 7.5\text{V} \leq V_{IN} \leq 15\text{V}$ (See Note 1)		5	10	5		25	mV
$\frac{\Delta V_{OUT}}{\Delta I_{OUT}}$	Load Regulation	$T_J = 25^\circ\text{C}, V_{IN} = 7.5\text{V}$ $0 \leq I_{OUT} \leq 3\text{A}$ (See Note 1)		25	50	25		100	mV
I_Q	Quiescent Current	$7.5\text{V} \leq V_{IN} \leq 15\text{V}, 0 \leq I_{OUT} \leq 3\text{A}$	●	12	20	12		20	mA
e_n	Output Noise Voltage	$T_J = 25^\circ\text{C}, 10\text{Hz} \leq f \leq 100\text{kHz}$		40		40			μV_{rms}
I_{SC}	Short Circuit Current Limit	$T_J = 25^\circ\text{C},$ $V_{IN} = 15\text{V}$ $V_{IN} = 7.5\text{V}$		3 4	4.5 6	3 4		4.5 5	A A
	Long Term Stability of Output Voltage	(See Note 3)			35			35	mV
θ_{JC}	Thermal Resistance Junction to Case	(See Note 3) K Package		1.8	2.5	1.8			$^\circ\text{C}/\text{W}$

The ● denotes the specifications which apply over the full operating temperature range.

Note 1: Load and line regulation are tested with pulsed low duty cycle techniques where pulse width $\leq 1\text{msec}$ and duty cycle $\leq 5\%$.

Note 2: $T_{min} = -55^\circ\text{C}$ for the LT123A/LM123 and 0°C for LT323A/LM323. $T_{max} = 150^\circ\text{C}$ for LT123A/LM123 and 125°C for LT323A/LM323.

Note 3: Guaranteed, but not tested.

ELECTRICAL CHARACTERISTICS (See Note 1)

SYMBOL	PARAMETER	CONDITIONS	LT323A			LM323			UNITS
			MIN	TYP	MAX	MIN	TYP	MAX	
V_{OUT}	Output Voltage	$T_j = 25^\circ\text{C}$, $V_{IN} = 7.5\text{V}$, $I_{OUT} = 0$	4.95	5.0	5.05	4.8	5.0	5.2	V
		$7.5\text{V} \leq V_{IN} \leq 15\text{V}$, $T_{MIN} \leq T_j \leq T_{MAX}$ $0 \leq I_{OUT} \leq 3\text{A}$, $P \leq 30\text{W}$ (Note 2)	● 4.85	5.0	5.15	4.75	5.0	5.25	V
$\frac{\Delta V_{OUT}}{\Delta V_{IN}}$	Line Regulation	$T_j = 25^\circ\text{C}$, $7.5\text{V} \leq V_{IN} \leq 15\text{V}$ (See Note 1)		5	10		5	25	mV
$\frac{\Delta V_{OUT}}{\Delta I_{OUT}}$	Load Regulation	$T_j = 25^\circ\text{C}$, $V_{IN} = 7.5\text{V}$ $0 \leq I_{OUT} \leq 3\text{A}$ (See Note 1)		25	50		25	100	mV
I_Q	Quiescent Current	$7.5\text{V} \leq V_{IN} \leq 15\text{V}$, $0 \leq I_{OUT} \leq 3\text{A}$	●	12	20		12	20	mA
e_n	Output Noise Voltage	$T_j = 25^\circ\text{C}$, $10\text{Hz} \leq f \leq 100\text{kHz}$		40			40		μV_{rms}
I_{SC}	Short Circuit Current Limit	$T_j = 25^\circ\text{C}$, $V_{IN} = 15\text{V}$ $V_{IN} = 7.5\text{V}$ (See Note 4)		3 4	4.5 6		3 4	4.5 5	A
	Long Term Stability of Output Voltage	(See Note 3)			35			35	mV
θ_{JC}	Thermal Resistance Junction to Case	(See Note 3) K Package T Package		1.8 2.5	2.5 4.0		1.8 3.0		$^\circ\text{C}/\text{W}$ $^\circ\text{C}/\text{W}$

The ● denotes the specifications which apply over the full operating temperature range.

Note 1: Load and line regulation are tested with pulsed low duty cycle techniques where pulse width $\leq 1\text{msec}$ and duty cycle $\leq 5\%$.

Note 2: $T_{min} = -55^\circ\text{C}$ for the LT123A/LM123 and 0°C for LT323A/LM323. $T_{max} = +150^\circ\text{C}$ for LT123A/LM123 and $+125^\circ\text{C}$ for LT323A/LM323.

Note 3: Guaranteed, but not tested.

Note 4: I_{SC} at $V_{IN} = 7.5\text{V}$ is 6A max for LM323T.

4

TYPICAL PERFORMANCE CHARACTERISTICS

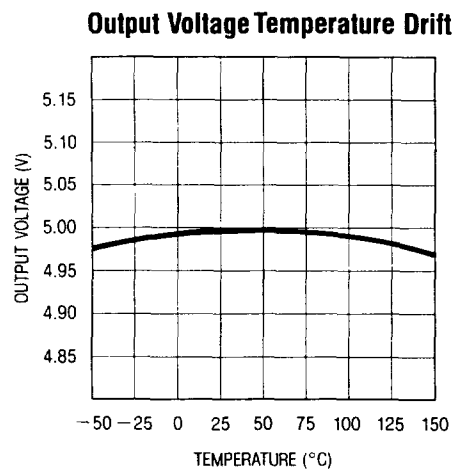
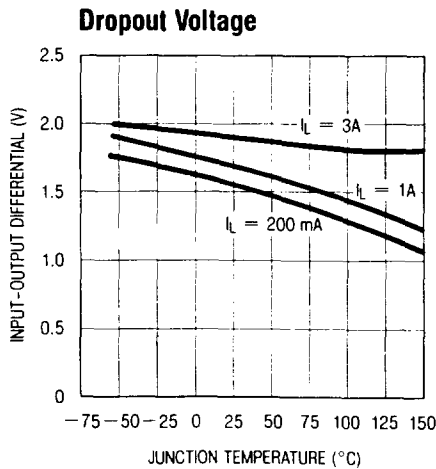

TYPICAL PERFORMANCE CHARACTERISTICS

Peak Available Output Current

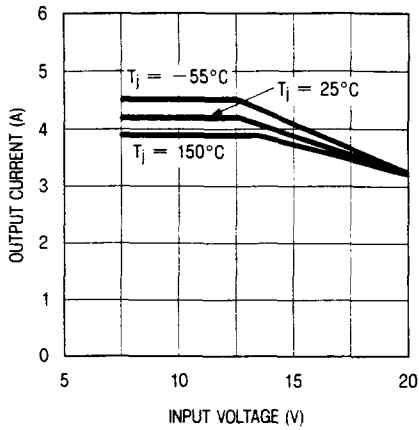

Suggested Heat Sink Thermal Resistance

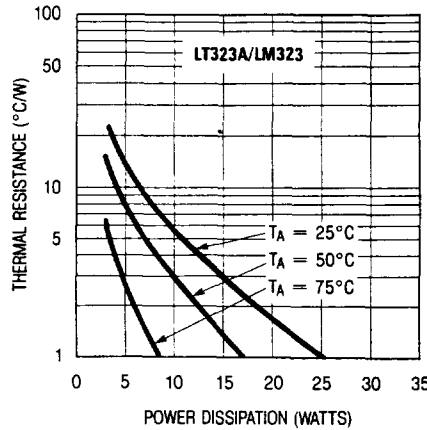

Suggested Heat Sink Thermal Resistance

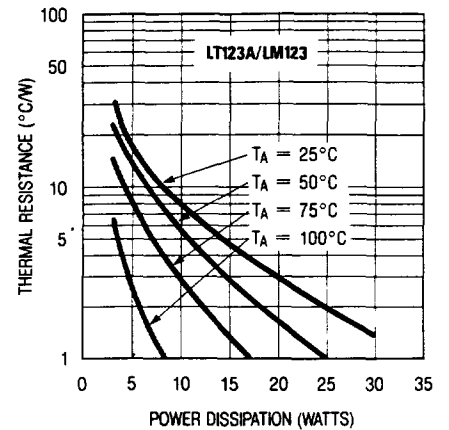

Output Impedance

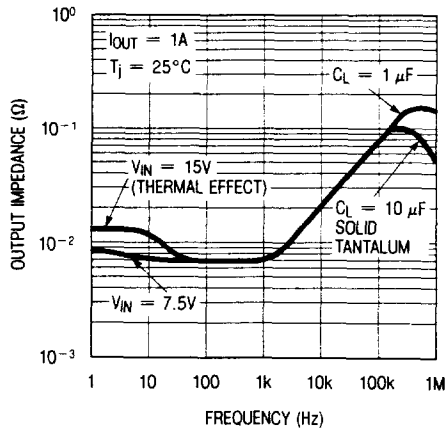

Output Noise Voltage

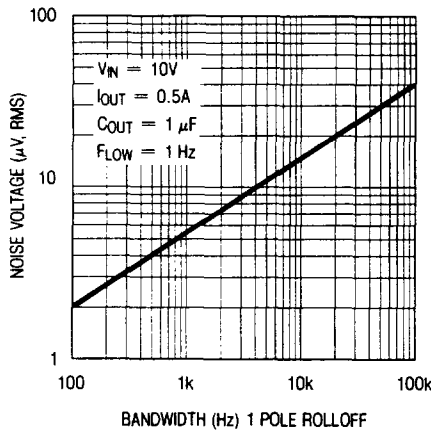

Ripple Rejection

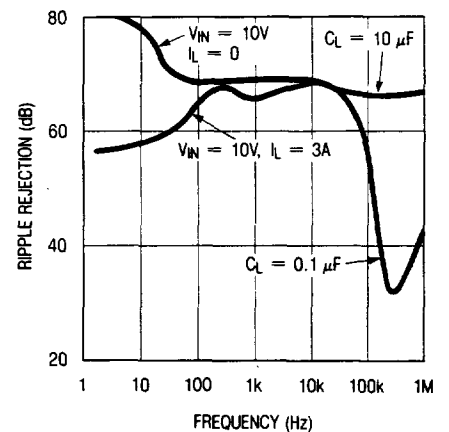

Line Transient Response

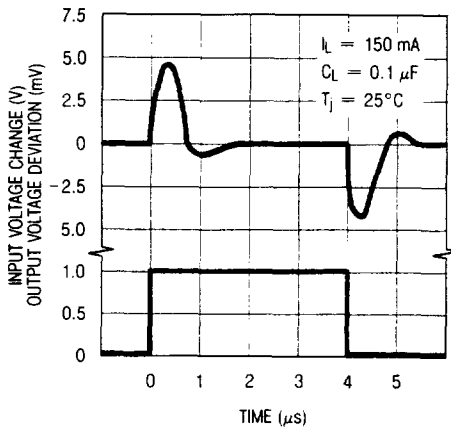

Load Transient Response

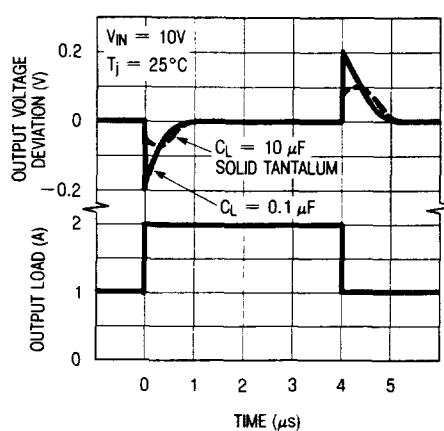

Quiescent Current

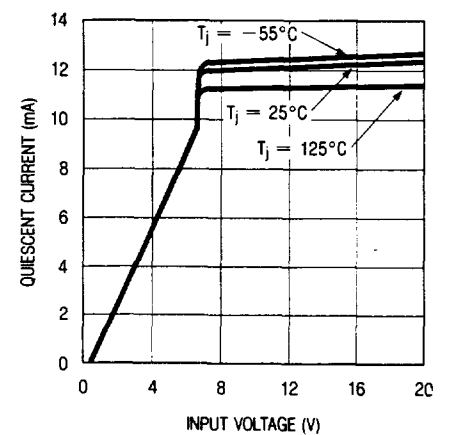

APPLICATIONS INFORMATION

Bypass Capacitors: The LT123A does not require an output capacitor for resistive loads. For almost all applications, however, a $1\mu\text{F}$ or larger solid tantalum capacitor should be used at the output within 2" of the regulator to improve the output impedance at high frequencies. For applications where very low high frequency impedance is required, a $10\mu\text{F}$ solid tantalum output capacitor is recommended. Total output capacitance either local or distributed may be increased without limit.

A $2\mu\text{F}$ or larger solid tantalum capacitor or a $25\mu\text{F}$ aluminum capacitor, must be used at the input if the regulator is more than 4" away from the large rectifier capacitor.

Avoiding Ground Loops: For best regulation, the ground pin of the LT123A should be tied directly to the load point as shown. This prevents excess drop in load voltage caused by load current flowing through the ground return lead. This is essentially a Kelvin connection for the low side of the regulator. A Kelvin connection cannot be made for the high output of regulator because only three pins are available on the package. Therefore, every attempt should be made to minimize the resistance between the output pin of the regulator and the load. #18 gauge hookup wire has a resistance of 0.006 ohms per foot. This translates to 0.36% change in load voltage at full load current. The LT123A is specified at 1% maximum load regulation, so one foot of wire represents a significant loss of regulation. If connectors are used, careful consideration must be given to contact resistance, especially if the connector is subjected to nasty ambients, vibration, or multiple insertions.

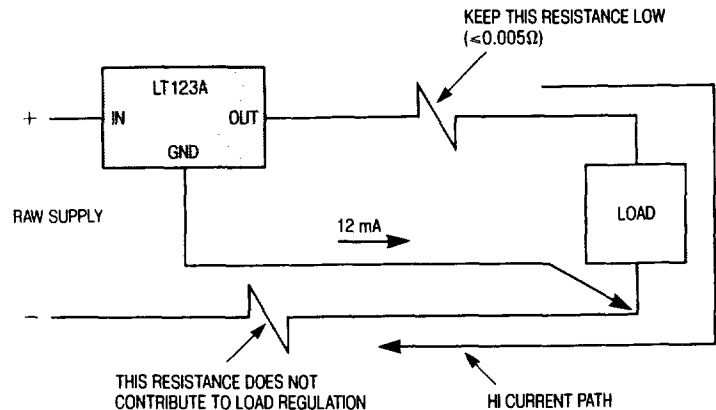

Raw Supply: Transformer, diode, and capacitor selection for the raw supply to the LT123A is very important because of the conflicting requirements for reliability, efficiency, and resistance to "brown-out" conditions. High secondary voltage on the transformer will cause unnecessarily high power dissipation in the regulator. Too low a secondary voltage will cause the regulator output to drop out of regulation with only a small reduction in AC mains voltage. The following formula gives a good starting point for transformer selection. This formula assumes a center tapped transformer, using two rectifier diodes.

where:

- $V_{\text{OUT}} = 5\text{V}$
- $V_{\text{DO}} =$ Minimum input-output differential of the regulator
- $V_{\text{RECT}} =$ Rectifier forward drop at $3I_{\text{OUT}}$
- $V_{\text{RIP}} = \frac{1}{2}$ p-p capacitor ripple voltage
 $\approx \frac{(5.3 \times 10^{-3})(I_{\text{OUT}})}{2C}$
- $V_{\text{NOM}} =$ Rated line voltage for the transformer (RMS)
- $V_{\text{LOW}} =$ Lowest expected line voltage (RMS)
- $I_{\text{OUT}} =$ DC output current

*1.1 is a nominal load regulation factor for the transformer

APPLICATIONS INFORMATION

Example: $I_{OUT} = 2.5A$, $V_{OUT} = 5V$
Assume: $V_{DO} = 2.5V$, $V_{RECT} = 1.1V$, $C = 8,000\mu F$
 $V_{NOM} = 115V$, $V_{LOW} = 0.88V$

$$V_{RIP} = \frac{(5.3 \times 10^{-3})(2.5)}{2(8 \times 10^{-3})} = 0.83V$$

$$V_{RMS} = \left(\frac{5 + 2.5 + 1.1 + 0.83}{\sqrt{2}} \right) \left(\frac{115}{05} \right) (1.1)$$

$$= 8.03 V_{RMS}$$

$$V_{RMS} = \left(\frac{V_{OUT} + V_{DO} + V_{RECT} + V_{RIP}}{\sqrt{2}} \right) \left(\frac{V_{NOM}}{V_{LOW}} \right) (1.1^*)$$

$$I_{RMS} = (I_{OUT}) (1.2)$$

PHI = 2np/g The filter capacitor should be at *least* $2000\mu F$ per amp of load current to minimize capacitor heating and ripple voltage. The diodes should be rated at 5–6 amps even though their average current is only 1.5A at full rated load current. The reason for this is that although the *average* current is 1.5A, the RMS current is typically twice this value. In addition, the diode must withstand very high surge currents during power turn-on. This surge can be 10–20 times the DC rating of the supply, depending on capacitor size and wiring resistance and inductance.

TYPICAL APPLICATIONS

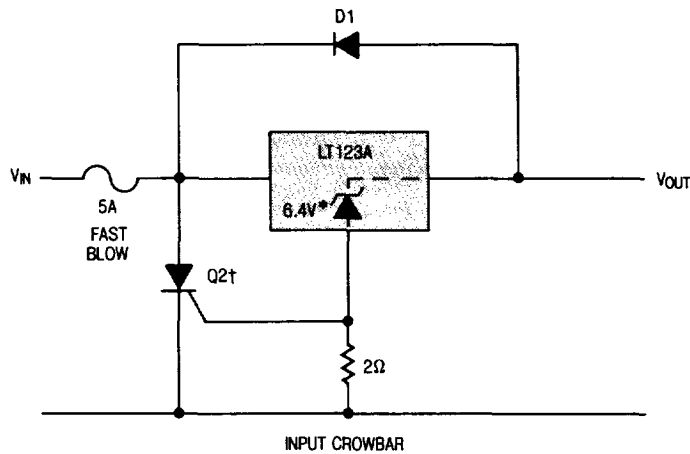

† Q2 AND D1 MUST WITHSTAND LARGE SURGE CURRENTS UNTIL THE 5A FUSE BLOWS. PEAK SURGE CURRENT IS LIMITED ONLY BY THE FUSE, WIRING, AND FILTER CAP RESISTANCE.

†† TRIP POINT IS APPROXIMATELY 7.3V.

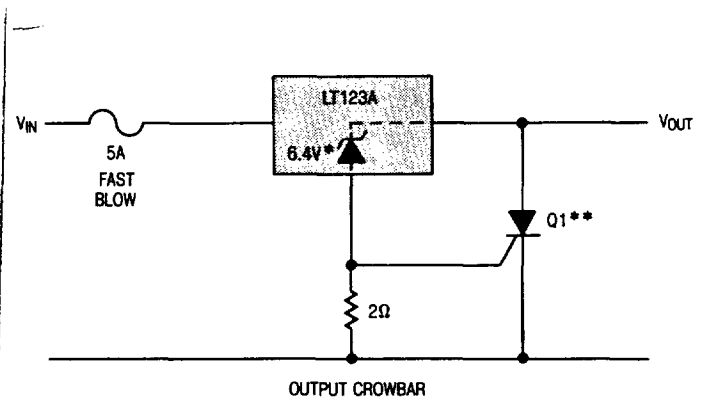

* THE 6.4V ZENER IS INTERNAL TO THE LT123A.

** Q1 MUST BE ABLE TO WITHSTAND CONTINUOUS CURRENTS OF 5A IF ADDITIONAL SYSTEM SHUTDOWN IS NOT USED.

SCHEMATIC DIAGRAM

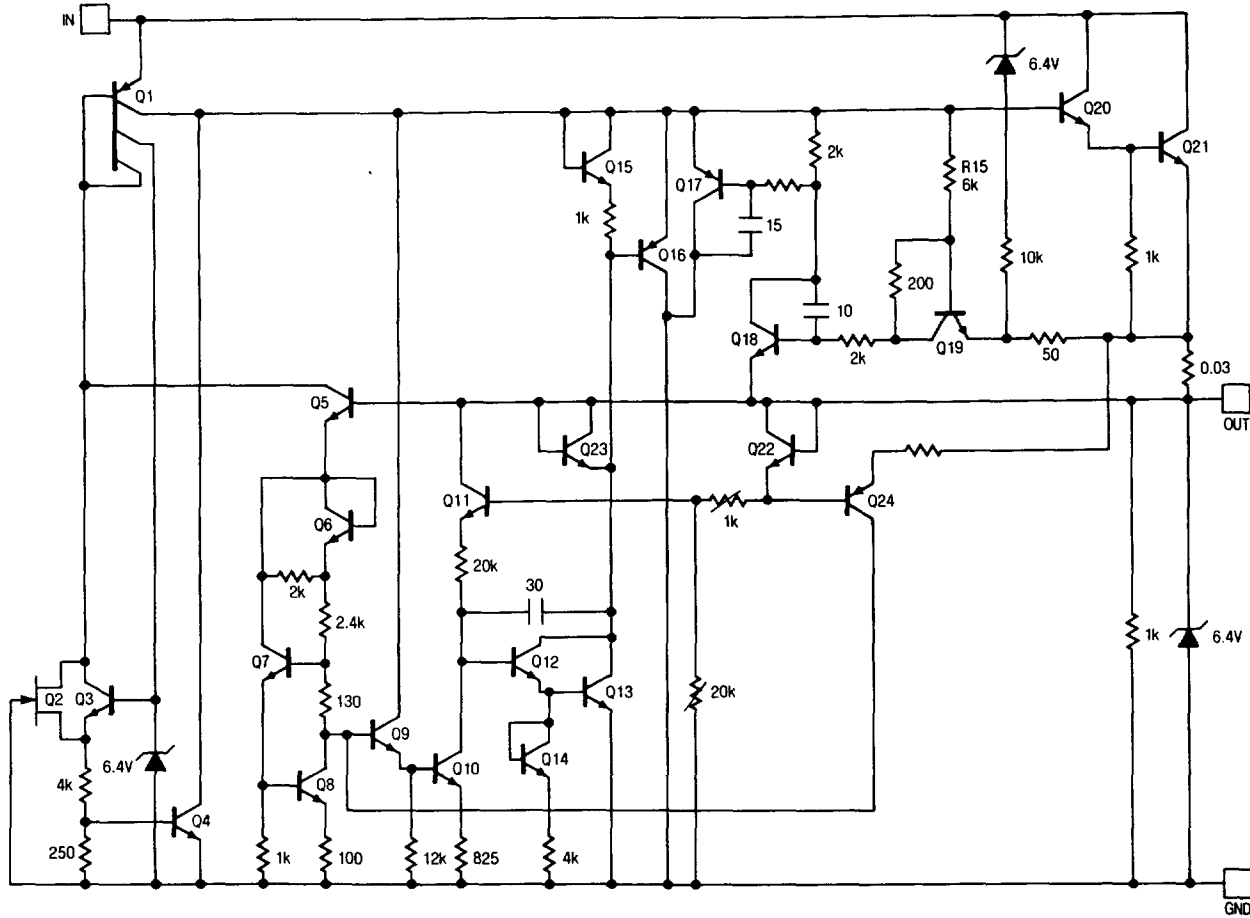

4

PACKAGE DESCRIPTION

K Package STEEL METAL CAN

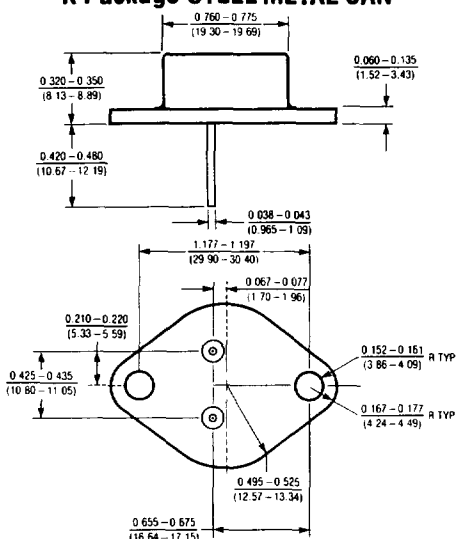

	T _j max.	θ _{ja}	θ _{jc}
LT123AK LM123K	150°C	35°C/W	1.8°C/W
LT323AK LM323K	125°C	35°C/W	1.8°C/W

T Package TO-220

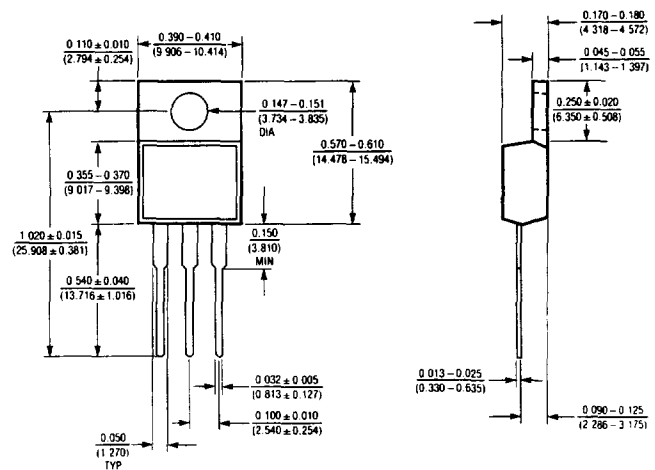

	T _j max.	θ _{ja}	θ _{jc}
LT323AT LM323T	125°C	50°C/W	2.5°C/W

X-ON Electronics

Largest Supplier of Electrical and Electronic Components

Click to view similar products for [LDO Voltage Regulators](#) category:

Click to view products by [Analog Devices](#) manufacturer:

Other Similar products are found below :

[AP7363-SP-13](#) [L79M05TL-E](#) [TCR3DF185,LM\(CT](#) [TCR3DF24,LM\(CT](#) [TCR3DF285,LM\(CT](#) [TCR3DF31,LM\(CT](#) [TCR3DF45,LM\(CT](#)
[MP2013GQ-33-Z](#) [059985X](#) [NCP4687DH15T1G](#) [701326R](#) [TCR2EN28,LF\(S](#) [NCV8170AXV250T2G](#) [TCR3DF27,LM\(CT](#)
[TCR3DF19,LM\(CT](#) [TCR3DF125,LM\(CT](#) [TCR2EN18,LF\(S](#) [AP2112R5A-3.3TRG1](#) [AP7315-25W5-7](#) [IFX30081LDVGRNXUMA1](#)
[NCV47411PAAJR2G](#) [AP2113KTR-G1](#) [AP2111H-1.2TRG1](#) [ZLDO1117QK50TC](#) [AZ1117IH-1.8TRG1](#) [AZ1117ID-ADJTRG1](#)
[TCR3DG12,LF](#) [MIC5514-3.3YMT-T5](#) [MIC5512-1.2YMT-T5](#) [MIC5317-2.8YM5-T5](#) [SCD7912BTG](#) [NCP154MX180270TAG](#) [SCD33269T-](#)
[5.0G](#) [NCV8170BMX330TCG](#) [NCV8170AMX120TCG](#) [NCP706ABMX300TAG](#) [NCP153MX330180TCG](#) [NCP114BMX075TCG](#)
[MC33269T-3.5G](#) [CAT6243-ADJCMT5T](#) [TCR3DG33,LF](#) [AP2127N-1.0TRG1](#) [TCR4DG35,LF](#) [LT1117CST-3.3](#) [TAR5S15U\(TE85L,F\)](#)
[TAR5S18U\(TE85L,F\)](#) [TCR3UG19A,LF](#) [TCR4DG105,LF](#) [NCV8170AMX360TCG](#) [MIC94310-NYMT-T5](#)