

## FEATURES

### Amplifier

- **Current Limit:  $\pm 40\text{mA}$  Typical**
- **Input Common Mode Range: 0V to 10V**
- **Output Voltage Range: 1V to ( $V_{CC} - 1\text{V}$ )**
- Differential Gain Stage with High Impedance Output ( $g_m$  Stage)
- Quiescent Current (from  $V_{CC}$ ): 2mA
- Unloaded Gain: 30,000 Typical

### Switching Regulator

- **Generates  $V_{CC}$  Up to 35V**
- Wide Operating Supply Range: 2.5V to 16V
- High Switching Frequency: 1.3MHz
- Internal Schottky Diode
- Tiny External Components
- Current Mode Switcher with Internal Compensation
- Low Profile (1mm) SOT-23 Package

## APPLICATIONS

- Piezo Speakers
- Piezo Microactuators
- Varactor Bias

## DESCRIPTION

The LT<sup>®</sup>3469 is a transconductance ( $g_m$ ) amplifier that can drive outputs up to 33V from a 5V or 12V supply. An internal switching regulator generates a boosted supply voltage for the  $g_m$  amplifier. The amplifier can drive capacitive loads in the range of 5nF to 300nF. Slew rate is limited only by the maximum output current. The 35V output voltage capability of the switching regulator, along with the high supply voltage of the amplifier, combine to allow the wide output voltage range needed to drive a piezoceramic microactuator.

The LT3469 switching regulator switches at 1.3MHz, allowing the use of tiny external components. The output capacitor can be as small as 0.22 $\mu\text{F}$ , saving space and cost versus alternative solutions.

The LT3469 is available in a low profile ThinSOT<sup>™</sup> package.

LT, LTC and LT are registered trademarks of Linear Technology Corporation. ThinSOT is a trademark of Linear Technology Corporation.

## TYPICAL APPLICATION

Piezo Microactuator Driver

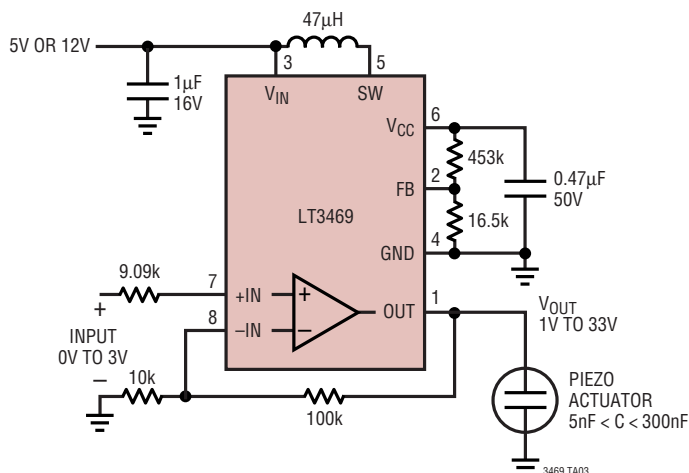

Response Driving a 33nF Load

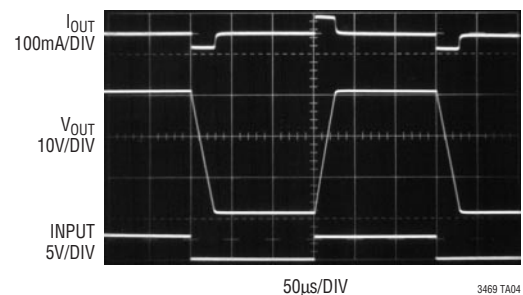

3469 TA04

## ABSOLUTE MAXIMUM RATINGS

(Note 1)

$V_{IN}$ Voltage .....	16V
SW Voltage .....	40V
$V_{CC}$ Voltage .....	38V
+IN, -IN Voltage .....	10V
FB Voltage .....	3V
Current Into SW Pin .....	1A
Operating Temperature Range (Note 2) ..	-40°C to 85°C
Storage Temperature Range .....	-65°C to 150°C
Lead Temperature (Soldering, 10 sec) .....	300°C

## PACKAGE/ORDER INFORMATION

	ORDER PART NUMBER
	LT3469ETS8
	TS8 PART MARKING
	LTACA

Consult LTC Marketing for parts specified with wider operating temperature ranges.

## ELECTRICAL CHARACTERISTICS

The ● denotes the specifications which apply over the full operating temperature range, otherwise specifications are at  $T_A = 25^\circ\text{C}$ . (Note 2)  $V_{IN} = 5\text{V}$ ,  $V_{CC} = 35\text{V}$ , unless otherwise noted.

PARAMETER	CONDITIONS	MIN	TYP	MAX	UNITS	
<b><math>g_m</math> Amplifier</b>						
Input Offset Voltage	$V_{OUT} = V_{CC}/2$	●	3	10	mV	
Input Offset Current		●	10	100	nA	
Input Bias Current		●	150	500	nA	
Input Resistance—Differential Mode			1		M $\Omega$	
Input Resistance—Common Mode			200		M $\Omega$	
Common Mode Rejection Ratio	$V_{CM} = 0\text{V to } 10\text{V}$		70	100	dB	
Power Supply Rejection Ratio— $V_{IN}$	$V_{IN} = 2.5\text{V to } 16\text{V}$		80	120	dB	
Power Supply Rejection Ratio— $V_{CC}$	$V_{CC} = 15\text{V to } 35\text{V}$		65	85	dB	
Gain	No Load, $V_{OUT} = 2\text{V to } 33\text{V}$ $R_L = 200\text{k}, V_{OUT} = 2\text{V to } 33\text{V}$		15 10	30 20	V/mV V/mV	
Transconductance	$I_{OUT} = \pm 100\mu\text{A}$	●	160 140	220 300	$\mu\text{A/mV}$ $\mu\text{A/mV}$	
Maximum Output Current	$V_{OUT} = V_{CC}/2$	●	$\pm 30$ $\pm 23$	$\pm 40$ $\pm 55$ $\pm 58$	mA mA	
Maximum Output Voltage, Sourcing	$V_{CC} = 35\text{V}, I_{OUT} = 10\text{mA}$ $V_{CC} = 35\text{V}, I_{OUT} = 0\text{mA}$		34.0 34.5	34.5 34.9	V V	
Minimum Output Voltage, Sinking	$I_{OUT} = -10\text{mA}$ $I_{OUT} = 0\text{mA}$		200 10	1000 500	mV mV	
Output Resistance	$V_{CC} = 35\text{V}, V_{OUT} = 2\text{V to } 33\text{V}$		100		k $\Omega$	
Supply Current— $V_{CC}$	$V_{CC} = 35\text{V}$		1.5	2	2.5	mA
<b>Switching Regulator</b>						
Minimum Operating Voltage				2.5	V	
Maximum Operating Voltage			16		V	
Feedback Voltage		●	1.19	1.23	1.265	V
FB Pin Bias Current		●	45	200	nA	
FB Line Regulation	$2.5\text{V} < V_{IN} < 16\text{V}$		0.03		%/V	
Supply Current— $V_{IN}$			1.9	2.6	mA	
Switching Frequency		●	0.8	1.3	1.7	MHz
Maximum Duty Cycle		●	88	91	%	
Switch Current Limit (Note 3)		●	165	220	mA	
Switch $V_{CESAT}$	$I_{SW} = 100\text{mA}$			350	500	mV

**ELECTRICAL CHARACTERISTICS** The ● denotes the specifications which apply over the full operating temperature range, otherwise specifications are at  $T_A = 25^\circ\text{C}$ . (Note 2)  $V_{IN} = 5\text{V}$ ,  $V_{CC} = 35\text{V}$ , unless otherwise noted.

PARAMETER	CONDITIONS	MIN	TYP	MAX	UNITS
Switch Leakage Current	$V_{SW} = 5\text{V}$		0.01	1	$\mu\text{A}$
Diode $V_F$	$I_D = 100\text{mA}$		740	1100	mV
Diode Reverse Leakage Current	$V_R = 5\text{V}$		0.1	1	$\mu\text{A}$

**Note 1:** Absolute Maximum Ratings are those values beyond which the life of a device may be impaired.

**Note 2:** The LT3469E is guaranteed to meet performance specifications from  $0^\circ\text{C}$  to  $85^\circ\text{C}$ . Specifications over the  $-40^\circ\text{C}$  to  $85^\circ\text{C}$  operating

temperature range are assured by design, characterization and correlation with statistical process controls.

**Note 3:** Current limit is guaranteed by design and/or correlation to static test. Slope compensation reduces current limit at higher duty cycles.

**TYPICAL PERFORMANCE CHARACTERISTICS**  
(Switching Regulator)

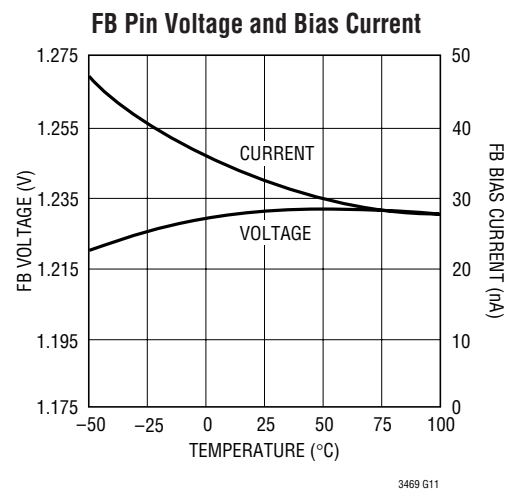
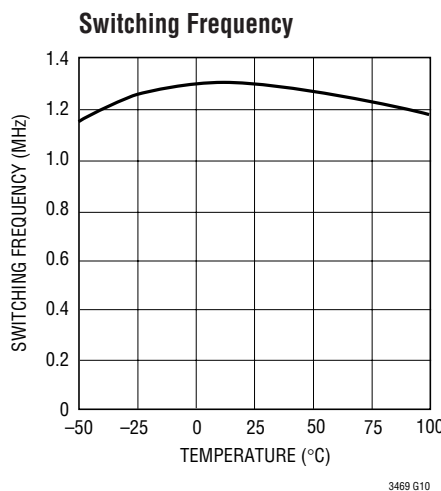
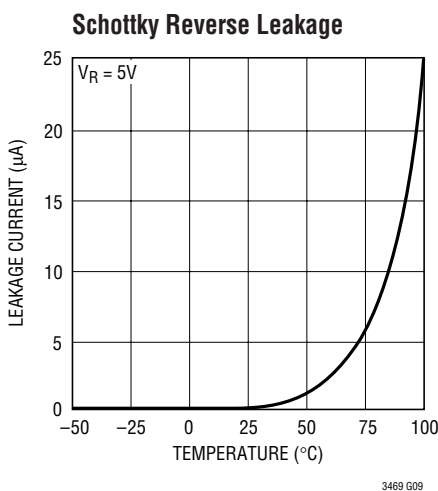
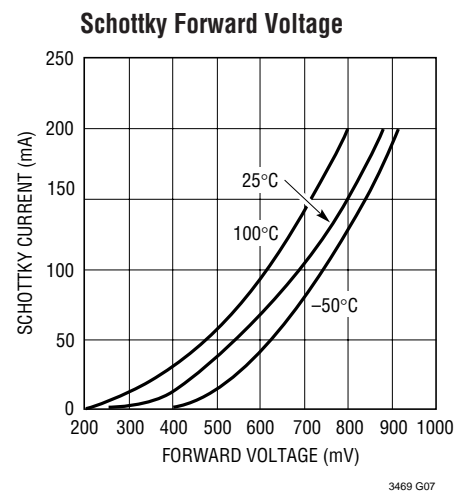
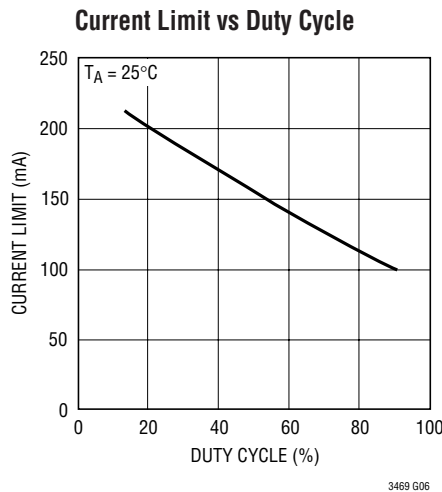
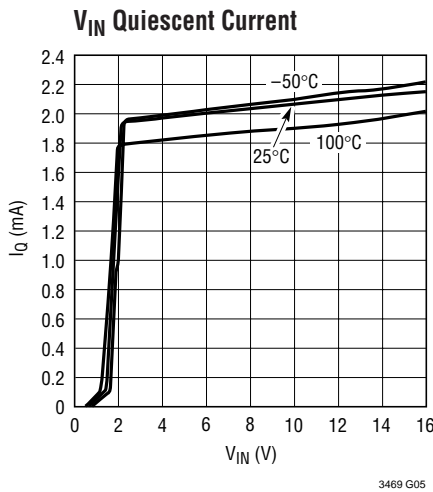

# TYPICAL PERFORMANCE CHARACTERISTICS

( $g_m$  Amplifier)

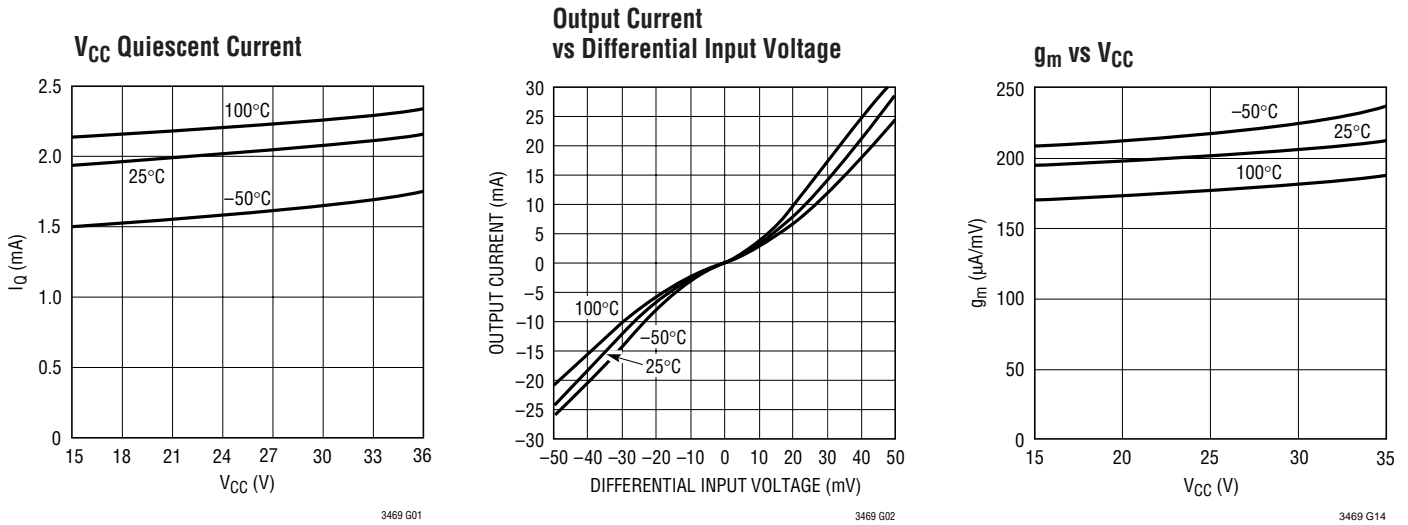

## PIN FUNCTIONS

**OUT (Pin 1):** Output of the  $g_m$  Amplifier. There must be at least 5nF of capacitive load at the output in a gain of 10 configuration. Capacitive loads up to 300nF can be connected to this pin. Piezo actuators below 5nF can be driven if capacitance is placed in parallel to bring the total capacitance to 5nF.

**FB (Pin 2):** Feedback Pin. Reference voltage is 1.23V. Connect feedback resistor divider here.

**$V_{IN}$  (Pin 3):** Input Supply Pin. Must be locally bypassed.

**GND (Pin 4):** Ground Pin. Connect directly to local ground plane.

**SW (Pin 5):** Switch Pin. Connect inductor here. Minimize trace area at this pin to reduce EMI.

**$V_{CC}$  (Pin 6):** Output of Switching Regulator and Supply Rail for  $g_m$  Amp. There must be 0.22 $\mu F$  or more of capacitance here.

**+IN (Pin 7):** Noninverting Terminal of the  $g_m$  Amplifier.

**-IN (Pin 8):** Inverting Terminal of the  $g_m$  Amplifier.

## BLOCK DIAGRAM

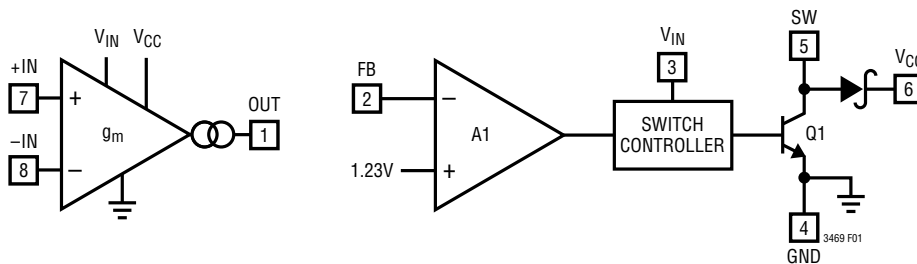

Figure 1. LT3469 Block Diagram

## OPERATION

### $g_m$ Amplifier

The LT3469 is a wide output voltage range  $g_m$  amplifier designed to drive capacitive loads. Input common mode range extends from 10V to ground. The output current is proportional to the voltage difference across the input terminals. When the output voltage has settled, the input terminals will be at the same voltage; supply current of the amplifier will be low and power dissipation will be low. If presented with an input differential, however, the output current can increase significantly, up to the maximum output current (typically 40mA). The output voltage slew rate is determined by the maximum output current and the output capacitance, and can be quite high. With a 10nF load, the output slew rate will typically be 4V/ $\mu$ s. The capacitive load compensates the  $g_m$  amplifier and must be present for stable operation. The gain capacitance product of the amplifier must be at least 50nF. For example, if the amplifier is operated in a gain of 10 configuration, a minimum capacitance of 5nF is necessary. In a gain of 20 configuration, a minimum of 2.5nF is necessary. Closed loop  $-3$ dB bandwidth is set by the output capacitance. Typical closed loop bandwidth is approximately:

$$\frac{g_m}{2\pi \cdot A_V \cdot C_{OUT}}$$

where  $g_m = 200\mu\text{A/mV}$

For example, an amplifier in a gain of 10 configuration with 10nF of output capacitance will have a closed loop  $-3$ dB bandwidth of approximately 300kHz. Figure 3 shows typi-

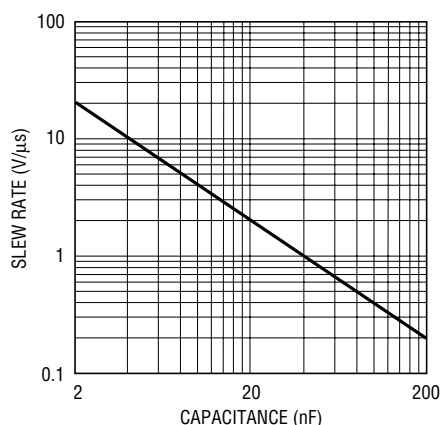

Figure 2. Slew Rate vs Capacitance

cal bandwidth of a gain of 10 configuration per output capacitance.

In applications where negative phase contributions below crossover frequency must be minimized, a phase boost capacitor can be added, as shown in Figure 4. Larger values of  $C_{BOOST}$  will further reduce the closed-loop negative phase contribution, however, the amplifier phase margin will be reduced. For an amplifier phase margin of approximately  $55^\circ$ , select  $C_{BOOST}$  as follows:

$$C_{BOOST} = \frac{C_{OUT}(R1/R2 + 1)}{g_m(R1 || R2)}$$

where  $g_m = 200\mu\text{A/mV}$ .

In a gain of 10 configuration, choosing  $C_{BOOST}$  as described will lead to nearly zero closed-loop negative phase contribution at 3kHz for values of  $C_{OUT}$  from 10nF to 200nF. The phase boost capacitor should not be used if  $C_{OUT}$  is less than twice the minimum for stable operation. The gain capacitance product should therefore be higher than 100nF if a phase boost capacitor is used.

### Switching Regulator

The LT3469 uses a constant frequency, current mode control scheme to provide excellent line and load regulation. Operation can be best understood by referring to the Block Diagram in Figure 1. The switch controller sets the peak current in Q1 proportional to its input. The input to the switch controller is set by the error amplifier, A1, and is

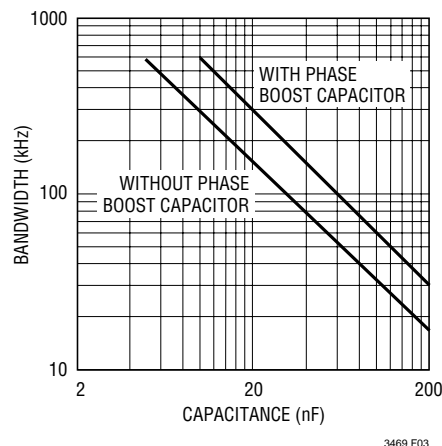
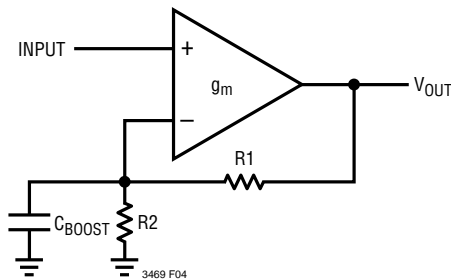

Figure 3. Closed Loop  $-3$ dB Bandwidth vs Capacitance in a Gain of 10 Configuration

## OPERATION



**Figure 4. Boosting the Bandwidth of the  $g_m$  Amplifier with Capacitance On the Inverting Input**

simply an amplified version of the difference between the feedback voltage and the reference voltage of 1.23V. In this manner, the error amplifier sets the correct peak current level to keep the output in regulation. If the error amplifier’s output increases, more current is delivered to the output; if it decreases, less current is delivered. The switching regulator provides the boosted supply voltage for the  $g_m$  amplifier.

### Inductor Selection

A 47 $\mu$ H inductor is recommended for most LT3469 applications. Some suitable inductors with small size are listed in Table 1. The efficiency comparison of different inductors is shown in Figure 5.

**Table 1. Recommended Inductors**

PART NUMBER	DCR ( $\Omega$ )	CURRENT RATING (mA)	MANUFACTURER
LQH32CN470	1.3	170	Murata 814-237-1431 www.murata.com
CMD4D11-470	2.8	180	Sumida 847-545-6700 www.Sumida.com
LBC2518T470M	1.9	150	Taiyo Yuden 408-573-4150 www.t-yuden.com

### Capacitor Selection

The small size of ceramic capacitors makes them ideal for LT3469 applications. X5R and X7R types are recommended because they retain their capacitance over wider voltage and temperature ranges than other types such as Y5V or Z5U. A 1 $\mu$ F input capacitor is sufficient for most LT3469 applications. A 0.22 $\mu$ F output capacitor is sufficient for stable

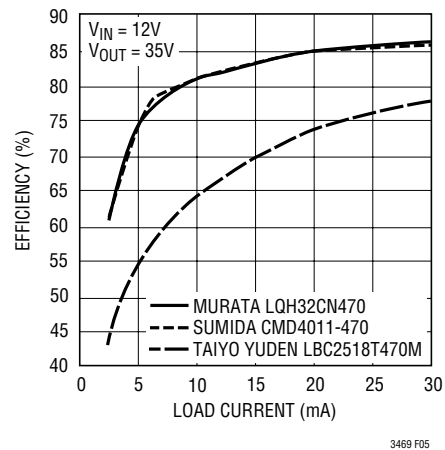

**Figure 5. Efficiency Comparison of Different Inductors**

transient response, however, more output capacitance can help limit the voltage droop on  $V_{CC}$  during transients.

**Table 2. Recommended Ceramic Capacitor Manufacturers**

MANUFACTURER	PHONE	URL
Taiyo Yuden	408-573-4150	www.t-yuden.com
AVX	843-448-9411	www.avxcorp.com
Murata	814-237-1431	www.murata.com
Kemet	408-986-0424	www.kemet.com

### Inrush Current Considerations When Hot Plugging

When the supply voltage is applied to  $V_{IN}$ , the voltage difference between  $V_{IN}$  and  $V_{CC}$  generates inrush current flowing from the input through the inductor, the SW pin, and the integrated Schottky diode to charge the output capacitor. Care should be taken not to exceed the LT3469 maximum SW pin current rating of 1A. Worst-case inrush current occurs when the application circuit is hot plugged into a live supply with a large output capacitance. The typical application circuit will maintain a peak SW pin current below 1A when it is hot plugged into a 5V supply. To keep SW pin current below 1A during a hot plug into a 12V supply, 4.7 $\Omega$  must be added between the supply and the LT3469 input capacitor. During normal operation, the SW pin current remains significantly less than 1A.

### Layout Hints

As with all switching regulators, careful attention must be paid to the PCB board layout and component placement. To maximize efficiency, switch rise and fall times are made

## OPERATION

as short as possible. To prevent electromagnetic interference (EMI) problems, proper layout of the high frequency switching path is essential. The voltage signal of the SW pin has sharp rise and fall edges. The SW pin should be surrounded on three sides by metal connected to  $V_{CC}$  to shield +IN and -IN. Minimize the area of all traces connected to the SW pin and always use a ground plane under the switching regulator to minimize interplane coupling. In addition, the ground connection for the feedback resistor R1 should be tied directly to the GND pin and not shared with any other component, ensuring a clean, noise-free connection. The ground return of the piezoceramic microactuator should also have a direct and unshared connection to the GND pin. The GND connection to R5 should be tied directly to the ground of the source generating the INPUT signal to avoid error induced by voltage drops along the GND line. Recommended component placement is shown in Figure 6.

### Thermal Considerations and Power Dissipation

The LT3469 combines large output drive with a small package. Because of the high supply voltage capability, it is possible to operate the part under conditions that exceed the maximum junction temperature. Maximum junction temperature ( $T_J$ ) is calculated from the ambient temperature ( $T_A$ ) and power dissipation ( $P_D$ ) as follows:

$$T_J = T_A + (P_D \cdot 250^\circ\text{C/W})$$

Worst-case power dissipation occurs at maximum output swing, frequency, capacitance and  $V_{CC}$ . For a square wave

input, power dissipation is calculated from the amplifier quiescent current ( $I_Q$ ), input frequency ( $f$ ), output swing ( $V_{OUT(P-P)}$ ), capacitive load ( $C_L$ ), amplifier supply voltage ( $V_{CC}$ ) and switching regulator efficiency ( $\eta$ ) as follows:

$$P_D = \frac{(I_Q + fV_{OUT(P-P)}C_L)(V_{CC})}{\eta}$$

Example: LT3469 at  $T_A = 70^\circ\text{C}$ ,  $V_{CC} = 35\text{V}$ ,  $C_L = 200\text{nF}$ ,  $f = 3\text{kHz}$ ,  $V_{OUT(P-P)} = 4\text{V}$ ,  $\eta = 80\%$ :

$$P_D = \frac{(2.5\text{mA} + 3\text{kHz} \cdot 4\text{V} \cdot 200\text{nF})(35\text{V})}{0.80} = 214\text{mW}$$

$$T_J = 70^\circ\text{C} + (214\text{mW} \cdot 250^\circ\text{C/W}) = 124^\circ\text{C}$$

Do not exceed the maximum junction temperature of  $125^\circ\text{C}$ .

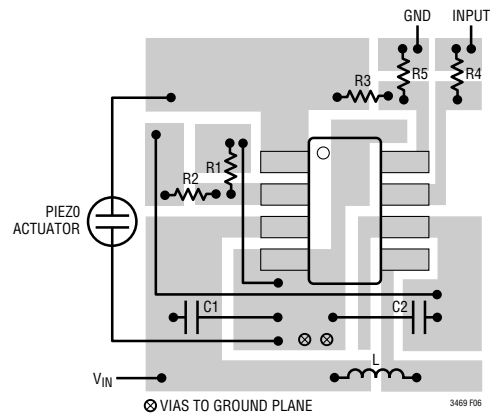
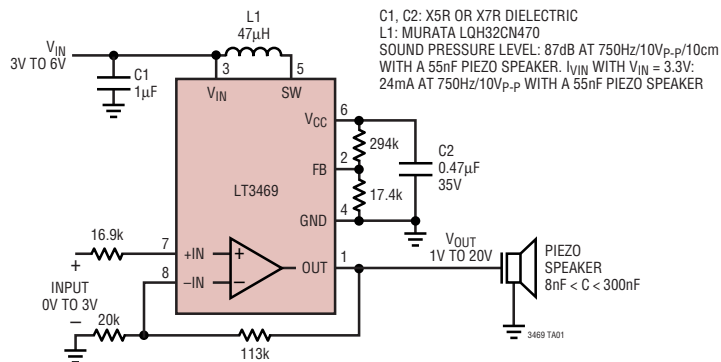

Figure 6. Recommended Component Placement

## TYPICAL APPLICATION

### Piezo Speaker Driver



# PACKAGE DESCRIPTION

**TS8 Package**  
**8-Lead Plastic TSOT-23**  
 (Reference LTC DWG # 05-08-1637)

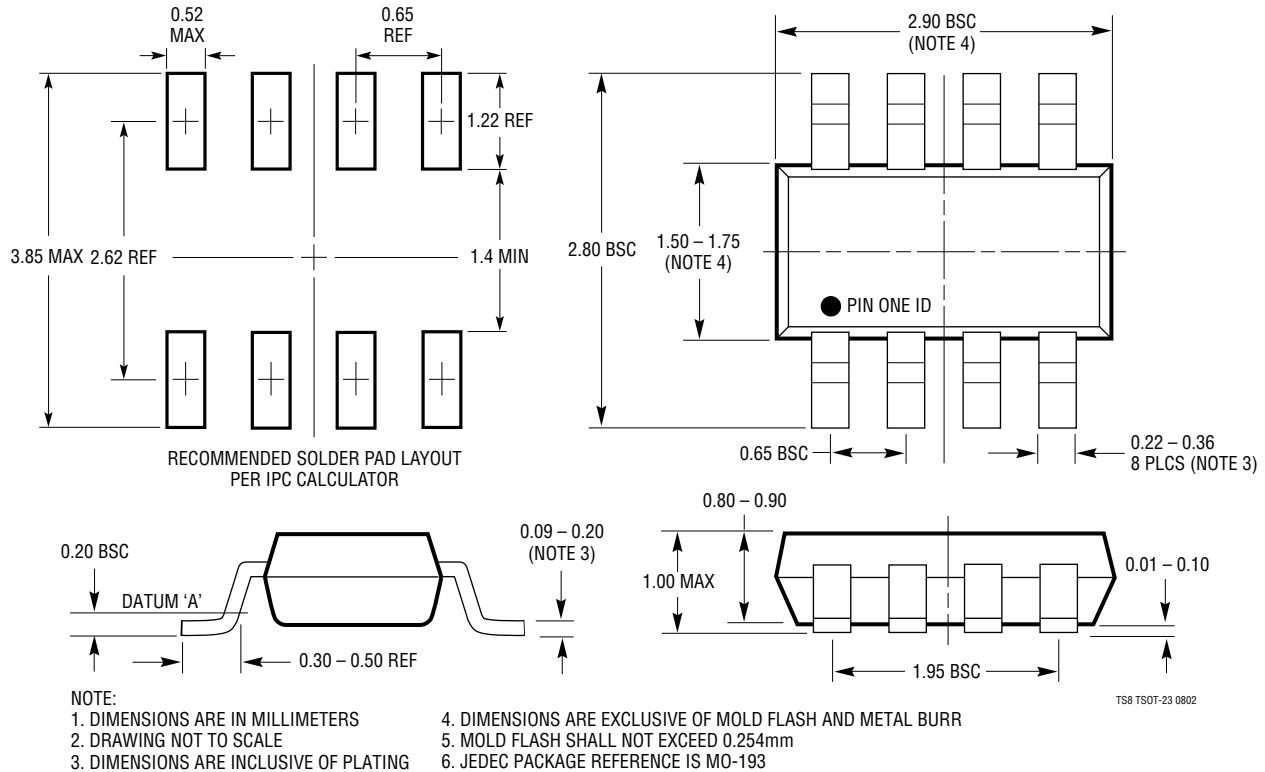

## RELATED PARTS

PART NUMBER	DESCRIPTION	COMMENTS
LT1611	550mA I <sub>SW</sub> , 1.4MHz, High Efficiency Inverting DC/DC Converter	V <sub>IN</sub> : 0.9V to 10V, V <sub>OUT(MAX)</sub> : 34V, I <sub>Q</sub> : 3mA, I <sub>SD</sub> : <1μA, ThinSOT
LT1616	600mA I <sub>OUT</sub> , 1.4MHz, High Efficiency Step-Down DC/DC Converter	V <sub>IN</sub> : 3.6V to 25V, V <sub>OUT(MIN)</sub> : 1.25V, I <sub>Q</sub> : 1.9mA, I <sub>SD</sub> : <1μA, ThinSOT
LTC1772B	550kHz, Current Mode Step-Down DC/DC Controller	V <sub>IN</sub> : 2.5V to 9.8V, V <sub>OUT(MIN)</sub> : 0.8V, I <sub>Q</sub> : 270μA, I <sub>SD</sub> : <8μA, ThinSOT
LT1931/LT1931A	1A I <sub>SW</sub> , 1.2MHz/2.2MHz, High Efficiency Inverting DC/DC Converter	V <sub>IN</sub> : 2.6V to 16V, V <sub>OUT(MAX)</sub> : -34V, I <sub>Q</sub> : 4.2mA, I <sub>SD</sub> : <1μA, ThinSOT
LT1940 (Dual)	Dual Output 1.4A I <sub>OUT</sub> , Constant 1.1MHz, High Efficiency Step-Down DC/DC Converter	V <sub>IN</sub> : 3V to 25V, V <sub>OUT(MIN)</sub> : 1.2V, I <sub>Q</sub> : 2.5mA, I <sub>SD</sub> : <1μA, TSSOP-16E
LTC3411	1.25A I <sub>OUT</sub> , 4MHz Synchronous Step-Down DC/DC Converter	V <sub>IN</sub> : 2.5V to 5.5V, V <sub>OUT(MIN)</sub> : 0.8V, I <sub>Q</sub> : 60μA, I <sub>SD</sub> : <1μA, MS10, DFN
LT3464	85mA I <sub>SW</sub> , Constant Off-Time, High Efficiency Step-Up DC/DC Converter with Integrated Schottky and Output Disconnect	V <sub>IN</sub> : 2.3V to 10V, V <sub>OUT(MAX)</sub> : 34V, I <sub>Q</sub> : 25μA, I <sub>SD</sub> : <0.5μA, ThinSOT



## X-ON Electronics

Largest Supplier of Electrical and Electronic Components

*Click to view similar products for [Switching Voltage Regulators](#) category:*

*Click to view products by [Analog Devices](#) manufacturer:*

Other Similar products are found below :

[FAN53610AUC33X](#) [FAN53611AUC123X](#) [FAN48610BUC33X](#) [FAN48610BUC45X](#) [FAN48617UC50X](#) [R3](#) [430464BB](#) [KE177614](#)  
[MAX809TTR](#) [NCV891234MW50R2G](#) [NCP81103MNTXG](#) [NCP81203PMNTXG](#) [NCP81208MNTXG](#) [NCP81109GMNTXG](#)  
[SCY1751FCCT1G](#) [NCP81109JMNTXG](#) [AP3409ADNTR-G1](#) [NCP81241MNTXG](#) [LTM8064IY](#) [LT8315EFE#TRPBF](#) [LTM4664EY#PBF](#)  
[LTM4668AIY#PBF](#) [NCV1077CSTBT3G](#) [XCL207A123CR-G](#) [MPM54304GMN-0002](#) [MPM54304GMN-0004](#) [MPM54304GMN-0003](#)  
[AP62300Z6-7](#) [MP8757GL-P](#) [MIC23356YFT-TR](#) [LD8116CGL](#) [HG2269M/TR](#) [OB2269](#) [XD3526](#) [U6215A](#) [U6215B](#) [U6620S](#) [LTC3412IFE](#)  
[LT1425IS](#) [MAX25203BATJA/VY+](#) [MAX77874CEWM+](#) [XC9236D08CER-G](#) [MP3416GJ-P](#) [BD9S201NUX-CE2](#) [MP5461GC-Z](#)  
[MPQ4415AGQB-Z](#) [MPQ4590GS-Z](#) [MAX38640BENT18+T](#) [MAX77511AEWB+](#) [MAX20406AFOD/VY+](#)