

Micropower 1A Boost Converter with Schottky and Output Disconnect

FEATURES

- Tiny Solution Size
- Low Quiescent Current:
 150 μ A in Active Mode ($V_{IN} = 3.6V$, $V_{OUT} = 15V$, No Load)
 1 μ A in Shutdown Mode
- Internal 1A, 36V Switch
- Integrated Schottky Diode
- Integrated PNP Output Disconnect
- Internal Reference Override Pin
- PGOOD Pin
- 25V at 80mA from 3.6V Input
- Auxiliary NPNs for Intermediate Bias Voltages (LT3473A)
- Automatic Burst Mode[®] Operation at Light Load
- Constant Switching Frequency: 1.2MHz
- Thermal Shutdown
- Input Range: 2.2V to 16V
- Low Profile (3mm \times 3mm) DFN Package (LT3473)
- Low Profile (4mm \times 3mm) DFN Package (LT3473A)

APPLICATIONS

- OLED Bias
- CCD Bias

DESCRIPTION

The LT[®]3473/LT3473A are micropower step-up DC/DC converters with integrated Schottky diode and output disconnect circuitry in low profile DFN packages. The small package size, high level of integration and the use of tiny SMT components yield a solution size of less than 50mm². The internal 1A switch allows the device to deliver 25V at up to 80mA from a Li-Ion cell, while automatic Burst Mode operation maintains efficiency at light load. An auxiliary reference input (CTRL) allows the user to override the internal 1.25V feedback reference with any lower value, allowing full control of the output voltage during operation. A PGOOD pin sinks current when the output voltage reaches 90% of final value.

The LT3473A includes two NPN transistors for generating intermediate bias voltages from the output and is offered in a 12-lead (4mm \times 3mm) DFN package. The LT3473 does not include these NPNs and is offered in an 8-lead (3mm \times 3mm) package.

The rugged 36V switch and output disconnect circuitry allow outputs up to 34V to be easily generated in a simple boost topology.

LT, LTC and LT are registered trademarks of Linear Technology Corporation. Burst Mode is a registered trademark of Linear Technology Corporation. All other trademarks are the property of their respective owners.

TYPICAL APPLICATION

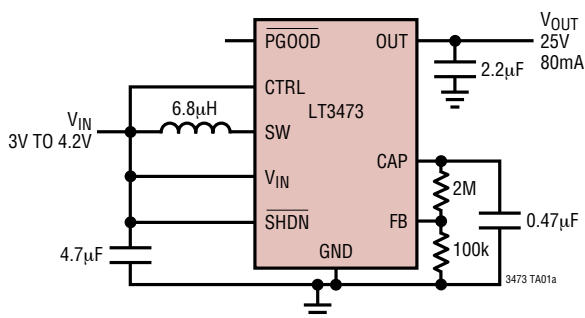

Conversion Efficiency and Power Loss vs Output Current

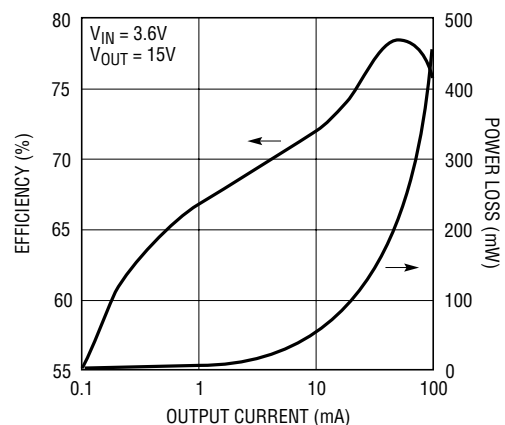

3473 TA01b

LT3473/LT3473A

ABSOLUTE MAXIMUM RATINGS (Note 1)

V_{IN} Voltage	16V	CTRL Voltage	10V
SHDN Voltage	16V	NB1, NB2 Voltage	36V
SW Voltage	36V	NE1, NE2 Voltage	36V
PGOOD Voltage	36V	Maximum Junction Temperature	125°C
CAP Voltage	36V	Operating Temperature Range (Note 2) ..	-40°C to 85°C
OUT Voltage	36V	Storage Temperature Range	-65°C to 125°C
FB Voltage	10V		

PACKAGE/ORDER INFORMATION

<p>DD PACKAGE 8-LEAD (3mm × 3mm) PLASTIC DFN</p> <p>$T_{JMAX} = 125^{\circ}\text{C}$, $\theta_{JA} = 43^{\circ}\text{C/W}$ EXPOSED PAD (PIN 9) IS GND MUST BE SOLDERED TO PCB (NOTE 3)</p>	ORDER PART NUMBER	<p>DE PACKAGE 12-LEAD (4mm × 3mm) PLASTIC DFN</p> <p>$T_{JMAX} = 125^{\circ}\text{C}$, $\theta_{JA} = 43^{\circ}\text{C/W}$ EXPOSED PAD (PIN 13) IS GND MUST BE SOLDERED TO PCB (NOTE 3)</p>	ORDER PART NUMBER
	LT3473EDD		LT3473AEDE
	DD PART MARKING		DE PART MARKING
	LBJJ		3473A

Consult LTC Marketing for parts specified with wider operating temperature ranges.

ELECTRICAL CHARACTERISTICS

The ● denotes specifications which apply over the full operating temperature range, otherwise specifications are $T_A = 25^{\circ}\text{C}$.
 $V_{IN} = 3\text{V}$, $\text{SHDN} = 3\text{V}$, $\text{CTRL} = 2\text{V}$, unless otherwise specified.

PARAMETER	CONDITIONS	MIN	TYP	MAX	UNITS
Minimum Operation Voltage		2.2			V
Maximum Operation Voltage				16	V
Supply Current	SHDN = 3V, Not Switching SHDN = 0V		100 0.1	1	μA μA
SHDN Voltage to Enable Chip		● 1.4			V
SHDN Voltage to Disable Chip				● 0.2	V
SHDN Pin Bias Current			2		μA
FB Voltage		● 1.235	1.25	1.26	V
FB Voltage Line Regulation	$3\text{V} < V_{IN} < 16\text{V}$		0.01		%/V
FB Pin Bias Current	FB = 1.27V		20		nA
CTRL to FB Offset	CTRL = 0.5V		5	20	mV
CTRL Pin Bias Current	CTRL = 1V		50		nA
FB Threshold for PGOOD	CTRL = 2V		1.15		V
	CTRL = 0.5V		0.40		V
PGOOD Current Capacity		● 100			μA

3473f

ELECTRICAL CHARACTERISTICS

The ● denotes specifications which apply over the full operating temperature range, otherwise specifications are $T_A = 25^\circ\text{C}$. $V_{IN} = 3\text{V}$, $\text{SHDN} = 3\text{V}$, $\text{CTRL} = 2\text{V}$, unless otherwise specified.

PARAMETER	CONDITIONS	MIN	TYP	MAX	UNITS
Switching Frequency		0.9	1.2	1.4	MHz
Maximum Duty Cycle		● 88	92		%
Switch Current Limit		● 1.2			A
Switch V_{CESAT}	$I_{SW} = 100\text{mA}$		45		mV
Switch Leakage Current	$V_{SW} = 5\text{V}$		0.1	5	μA
Schottky Forward Drop	$I_D = 100\text{mA}$		0.45		V
Schottky Leakage Current	$\text{CAP} = 36\text{V}$, $\text{SW} = 0\text{V}$			4	μA
Disconnect PNP Voltage Drop	$I_{OUT} = 100\mu\text{A}$, $\text{CAP} = 20\text{V}$ $I_{OUT} = 50\text{mA}$, $\text{CAP} = 20\text{V}$		80 250		mV mV
Disconnect PNP Quiescent Current	$\text{CAP} = 20\text{V}$		1.2		μA
Disconnect PNP Leakage Current	$\text{SHDN} = \text{OUT} = 0\text{V}$, $\text{CAP} = 20\text{V}$		0.01	0.1	μA

LT3473A Only

NPN1 Voltage Drop	$\text{INE1} = 1\text{mA}$		0.8		V
NPN1 Beta	$\text{INE1} = 1\text{mA}$	60			
NPN2 Voltage Drop	$\text{INE2} = 1\text{mA}$		0.8		V
NPN2 Beta	$\text{INE2} = 1\text{mA}$	60			

Note 1: Absolute Maximum Ratings are those values beyond which the life of a device may be impaired.

Note 2: The LT3473EDD and LT3473AEDE are guaranteed to meet performance specifications from 0°C to 70°C . Specifications over the -40°C to 85°C operating temperature range are assured by design, characterization and correlation with statistical process controls.

Note 3: Failure to correctly solder the Exposed Pad of the package to the PC board will result in a thermal resistance much higher than 40°C .

TYPICAL PERFORMANCE CHARACTERISTICS $T_A = 25^\circ\text{C}$ unless otherwise noted.

Load Regulation (Feedback Taken from CAP)

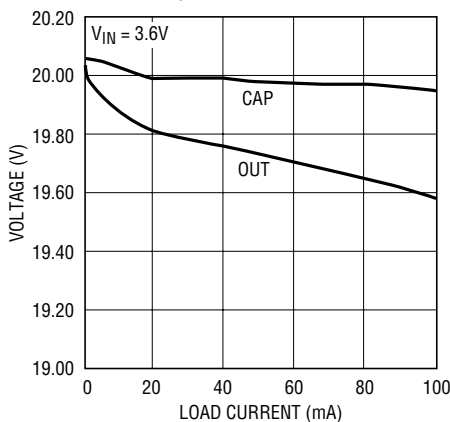

3473 G01

Feedback Voltage

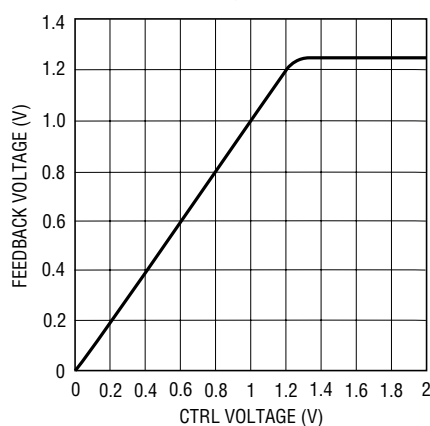

3473 G02

PGOOD Threshold Voltage

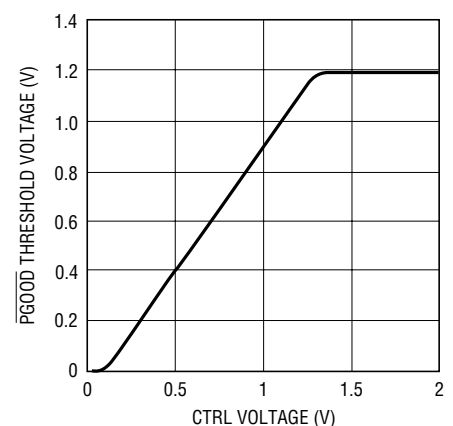

3473 G03

TYPICAL PERFORMANCE CHARACTERISTICS $T_A = 25^\circ\text{C}$ unless otherwise noted.

Sleep Mode Quiescent Current

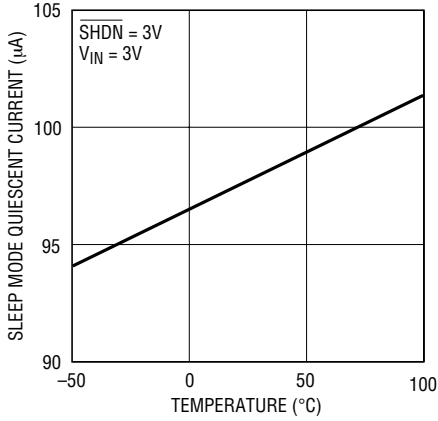

3473 G04

Sleep Mode Quiescent Current (Not Switching)

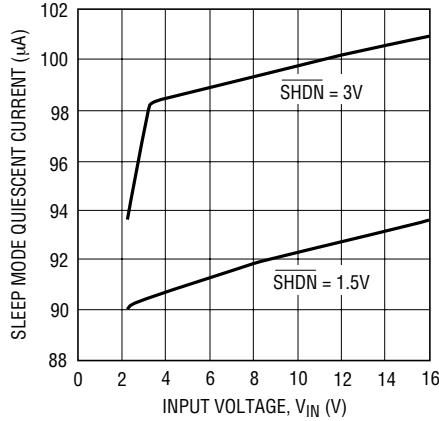

3473 G5

SHDN Pin Current

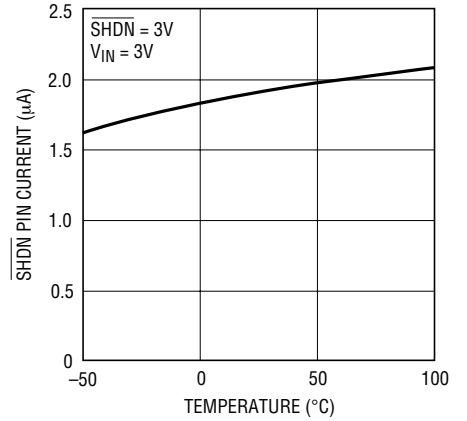

3473 G06

Switch $V_{CE(SAT)}$

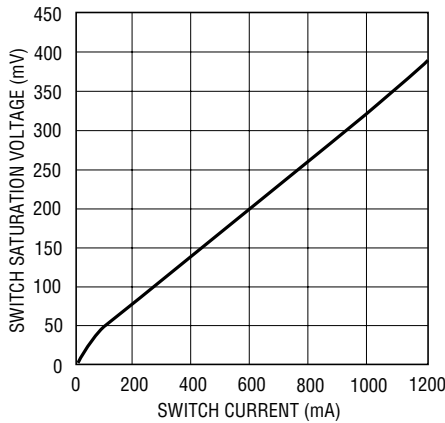

3473 G07

Switch Saturation Voltage

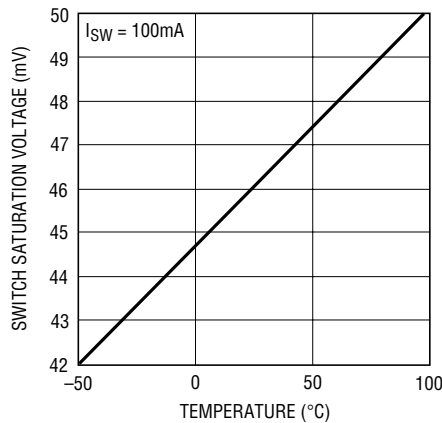

3473 G08

Schottky I-V Characteristic

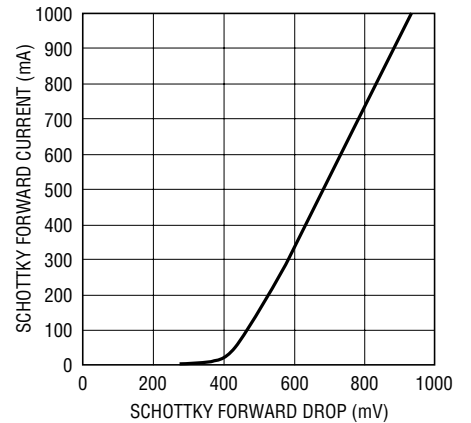

3473 G09

Schottky Forward Voltage

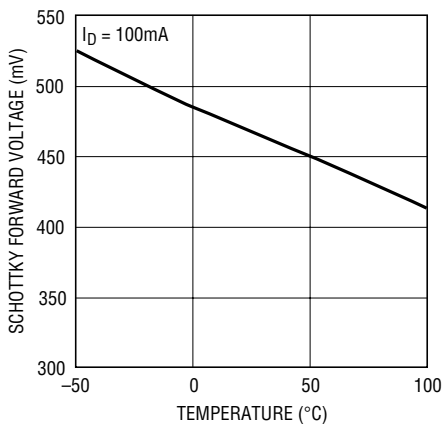

3473 G10

Output Disconnect Voltage Drop

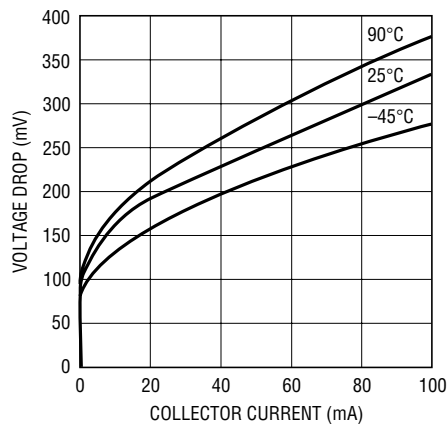

3473 G11

Switching Frequency

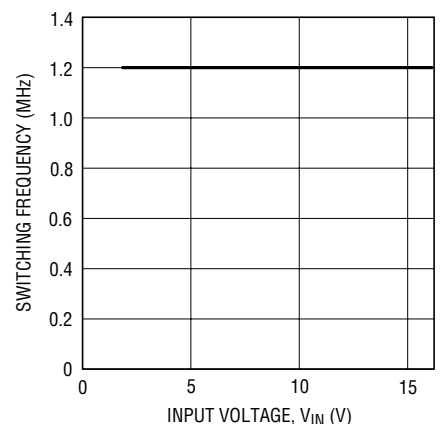

3473 G12

TYPICAL PERFORMANCE CHARACTERISTICS $T_A = 25^\circ\text{C}$ unless otherwise noted.

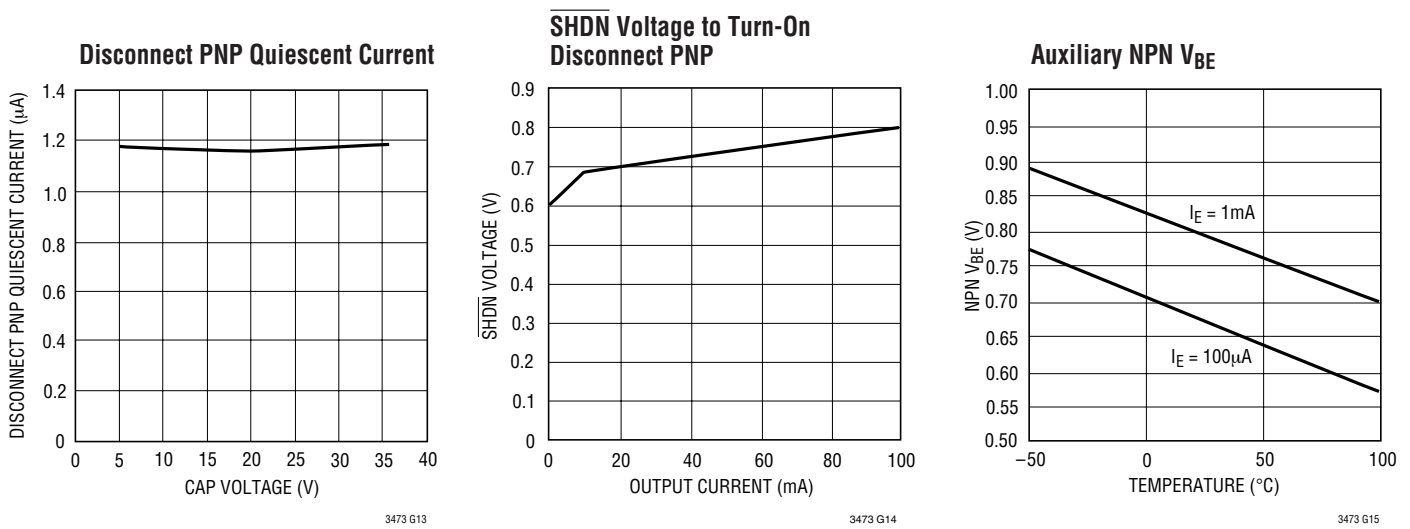

PIN FUNCTIONS (LT3473/LT3473A)

CAP (Pin 1/Pin 1): Internal Output Voltage. This pin is the Schottky cathode and disconnect PNP emitter. Connect output capacitor here.

OUT (Pin 2/Pin 2): Output of Disconnect Circuit. Bypass this pin with capacitor to ground.

CTRL (Pin 3/Pin 8): External Reference Pin. This pin sets the FB voltage externally between 0V and 1.25V. Tie this pin 1.5V or higher to use the internal 1.25V reference.

FB (Pin 4/Pin 7): Feedback Pin. Pin voltage is regulated to 1.25V if internal reference is used or to the CTRL pin voltage if the CTRL pin voltage is between 0V and 1.25V. Connect the feedback resistor divider to this pin. The output voltage is regulated to:

$$V_{OUT} = V_{REF} \cdot \left(\frac{R2}{R1} + 1 \right)$$

PGOOD (Pin 5/Pin 9): Power Good Output. Open collector logic output that starts to sink current when FB reaches within 100mV of the reference voltage.

SHDN (Pin 6/Pin 10): Shutdown Pin. Connect to 1.4V or higher to enable device; 0.2V or less to disable device. Also functions as soft-start. Use RC filter as shown in Figure 4.

V_{IN} (Pin 7/Pin 11): Input Supply Pin. Must be locally bypassed with a X5R or X7R type ceramic capacitor.

SW (Pin 8/Pin 12): Switch Pin. Connect inductor here. Minimize the metal trace area connected to the pin to minimize EMI.

Exposed Pad (Pin 9/Pin 13): Ground. Solder directly to PCB ground plane through multiple vias under the package for optimum thermal performance.

LT3473A Only

NB1 (Pin 3): NPN1 Base.

NE1 (Pin 4): NPN1 Emitter.

NB2 (Pin 5): NPN2 Base.

NE2 (Pin 6): NPN2 Emitter.

APPLICATIONS INFORMATION

Operation

The LT3473 combines a current mode, fixed frequency PWM architecture with Burst Mode micropower operation to maintain high efficiency at light loads. Operation can best be understood by referring to the Block Diagram.

The reference of the part is determined by the lower of the internal 1.25V bandgap reference and the voltage at the CTRL pin. The error amplifier compares voltage at the FB pin with the reference and generates an error signal V_C . When V_C is below the Burst Mode threshold voltage, B_{TH} , the hysteretic comparator, A1, shuts off the power section leaving only the low power circuitry running. Total current consumption in this state is minimized. As output loading

causes the FB voltage to decrease, V_C increases causing A1 to enable the power section circuitry. The chip starts switching. If the load is light, the output voltage (and FB voltage) will increase until A1 turns off the power section. The output voltage starts to fall again. This cycle repeats and generates low frequency ripple at the output. This Burst Mode operation keeps the output regulated and reduces average current into the IC, resulting in high efficiency at light load. If the output load increases sufficiently, A1's output remains high, resulting in continuous operation.

At the start of each oscillator cycle, the SR latch is set, turning on the power switch Q1. A voltage proportional to the switch current is added to a stabilizing ramp and the

Switching Waveforms

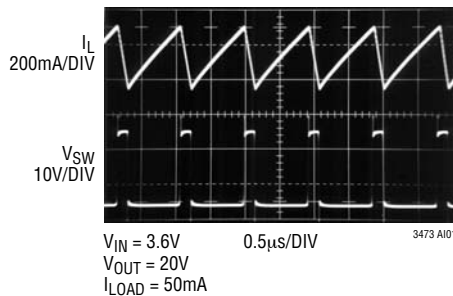

Switching Waveforms

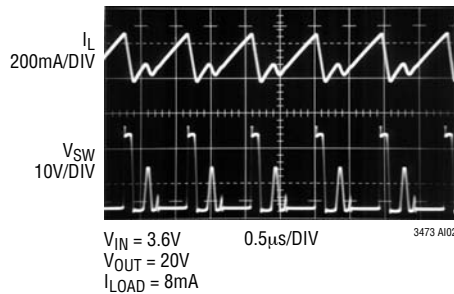

Transient Response

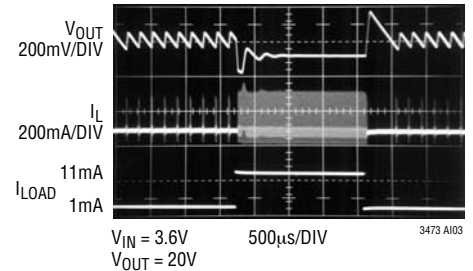

Transient Response

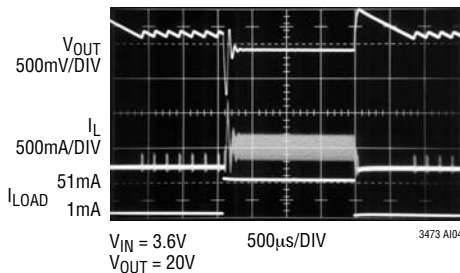

Transient Response

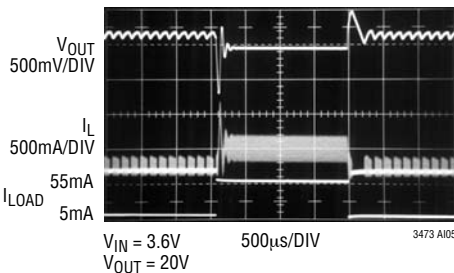

Transient Response

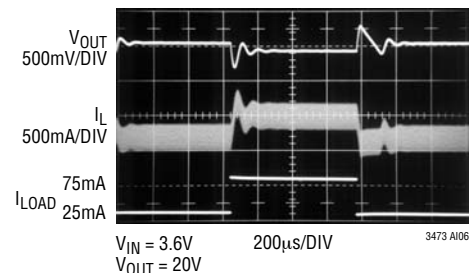

Shutdown Waveforms

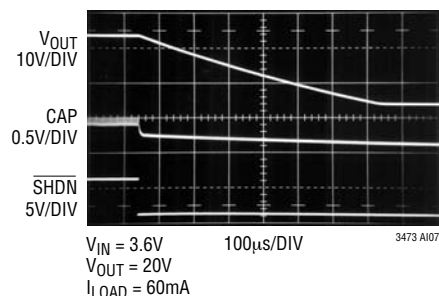

Start-Up Waveforms

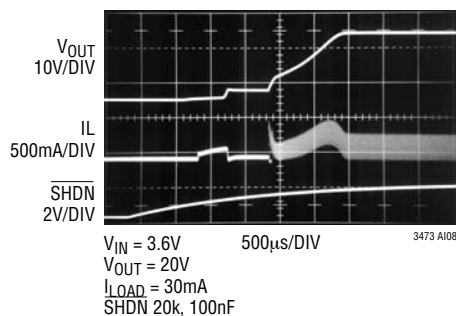

APPLICATIONS INFORMATION

resulting sum is fed into the positive terminal of the PWM comparator A2. When this voltage exceeds the level of the error signal V_C , the SR latch is reset, turning off the power switch Q1. The error amplifier sets the peak current level to keep the output in regulation. If the error amplifier's output increases, more current is delivered to the output; if it decreases, less current is delivered.

The LT3473 includes an internal power Schottky diode and a PNP transistor, Q2, for output disconnect. Q2 disconnects the load from the input during shutdown. The part also has a power good indication pin, PGOOD. When the FB voltage reaches within 100mV of the reference voltage, the comparator A4 turns on Q5, sinking current from PGOOD pin.

The LT3473 has thermal shutdown feature with threshold at about 145°C.

Inductor Selection

A 6.8μH inductor is recommended for the LT3473. The minimum inductor size that may be used in a given application depends on required efficiency and output current.

Inductors with low core losses and small DCR (copper wire resistance) at 1.2MHz are good choices for LT3473 applications. Some inductors in this category with small size are listed in Table 1. The efficiency comparison of different inductors is shown in Figure 3.

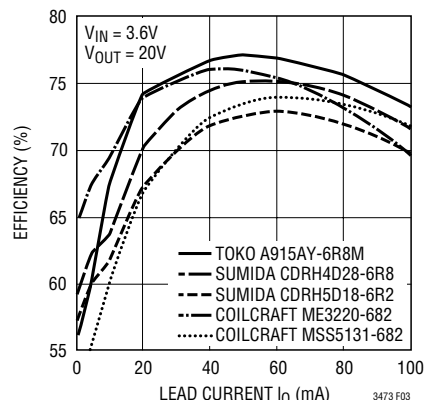

Figure 3. Efficiency Comparison of Different Inductors

Capacitor Selection

The small package of ceramic capacitors makes them suitable for LT3473 applications. X5R and X7R types of ceramic capacitors are recommended because they retain their capacitance over wider voltage and temperature ranges than other types such as Y5V or Z5U. A 4.7μF input capacitor, a 0.47μF output capacitor and a 2.2μF capacitor bypassing output disconnect PNP are sufficient for most LT3473 applications.

Table 2. Recommended Ceramic Capacitor Manufacturers

MANUFACTURER	TELEPHONE	URL
Taiyo Yuden	408-573-4150	www.t-yuden.com
AVX	843-448-9411	www.avxcorp.com
Murata	814-237-1431	www.murata.com
Kemet	408-986-0424	www.kemet.com

Table 1. Recommended Inductors

PART	DCR (mΩ)	CURRENT RATING (A)	DIMENSION (mm)	MANUFACTURER
DO1605T-682	200	1.1	5.4 × 4.2 × 1.8	Coilcraft 800-322-2645 www.coilcraft.com
ME3220-682	270	1.0	3.2 × 2.5 × 2.0	
MSS6122-682	100	1.45	6.1 × 6.1 × 2.2	
MSS5131-682	60	1.05	5.1 × 5.1 × 3.1	
LQH55DN6R8	74	2.0	5.7 × 5.0 × 4.7	Murata 814-237-1431 www.murata.com
CDRH5D18-6R2	71	1.4	5.7 × 5.7 × 2.0	Sumida 847-956-0666 www.sumida.com
CDRH4D28-6R8	81	1.12	4.7 × 4.7 × 3.0	
CDRH5D28-6R2	33	1.8	5.7 × 5.7 × 3.0	
CRD53-4R7	74	1.68	6.0 × 5.2 × 3.2	
A918CY-6R2M (TYPE D62LCB)	62	1.49	6.0 × 6.0 × 2.0	Toko 408-432-8281 www.tokoam.com
A915AY-6R8M (TYPE D53LC)	68	1.51	5.0 × 5.0 × 3.0	

APPLICATIONS INFORMATION

Inrush Current

The LT3473 has an integrated Schottky power diode. When supply voltage is abruptly applied to the V_{IN} pin while the output capacitor is discharged, the voltage difference between V_{IN} and CAP generates inrush current flowing from the input through the inductor and the internal Schottky diode to charge the output capacitor at the CAP pin. The maximum current the LT3473's Schottky can sustain is 2A. The selection of inductor and capacitor values should ensure that the peak inrush current is less than 2A. Peak inrush current can be calculated as follows:

$$I_P = \frac{V_{IN} - 0.6}{L \cdot \omega} \cdot \exp\left(-\frac{\alpha}{\omega} \cdot \arctan\left(\frac{\omega}{\alpha}\right)\right) \cdot \sin\left(\arctan\left(\frac{\omega}{\alpha}\right)\right)$$

$$\alpha = \frac{r + 1.5}{2 \cdot L}$$

$$\omega = \sqrt{\frac{1}{L \cdot C} - \frac{r}{4 \cdot L^2}}$$

where L is the inductance, r is the resistance of the inductor and C is the output capacitance. For a low DCR inductor, which is usually the case for this application, the peak inrush current can be simplified as follows:

$$I_P = \frac{V_{IN} - 0.6}{L \cdot \omega} \cdot \exp\left(-\frac{\alpha}{\omega} \cdot \frac{\pi}{2}\right)$$

A large abrupt voltage step at V_{IN} and/or a large capacitor at the CAP pin generate larger inrush current. Table 3 gives inrush peak currents for some component selections. An inductor with low saturation current could generate very large inrush current. For this case, inrush current should be measured to ensure safe operation. Note that inrush current is not a concern if the input voltage rises slowly.

Table 3. Inrush Peak Current

V_{IN} (V)	R (Ω)	L (μ H)	C (μ F)	I_P (A)
5	0.05	6.8	0.47	0.86
10	0.05	6.8	0.47	1.83
3.6	0.05	6.8	0.47	0.58
3.6	0.05	4.7	0.47	0.67

Setting the Output Voltages

The LT3473 has both an internal 1.25V reference and an external reference input. This allows the user to select between using the built-in reference and supplying an external reference voltage. The voltage at the CTRL pin can be adjusted while the device is operating to alter the output voltage for purposes such as display dimming or contrast adjustment. To use the internal 1.25V reference, the CTRL pin must be held higher than 1.5V. When the CTRL pin is held between 0V and 1.2V, the LT3473 will regulate the output such that the FB pin voltage is equal to the CTRL pin voltage.

The CAP pin should be used as the feedback node. To set the output voltage, select the values of R1 and R2 according to the following equation.

$$V_{INT} = V_{REF} \cdot \left(1 + \frac{R2}{R1}\right)$$

where $V_{REF} = 1.25V$ if the internal reference is used, or $V_{REF} = V_{CTRL}$ if V_{CTRL} is between 0V and 1.2V.

To maintain output voltage accuracy, 1% resistors are recommended.

Soft-Start

The \overline{SHDN} pin also functions as soft-start. Use an RC filter at the \overline{SHDN} pin to limit the start-up current. The small bias current of the \overline{SHDN} pin allows using a small capacitor for a large RC time constant.

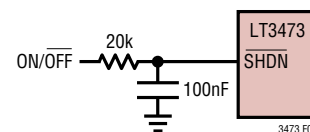

Figure 4. Soft-Start Circuitry

Output Disconnect Considerations

The LT3473 has an output disconnect PNP that isolates the load from the input during shutdown. The drive circuit maintains the PNP at the edge of saturation, adaptively according to the load, thus yielding the best compromise between V_{CESAT} and quiescent current to minimize power loss. To remain stable, it requires a bypass capacitor connected between the OUT pin and the CAP pin or

PACKAGE DESCRIPTION

DD Package 8-Lead Plastic DFN (3mm × 3mm) (Reference LTC DWG # 05-08-1698)

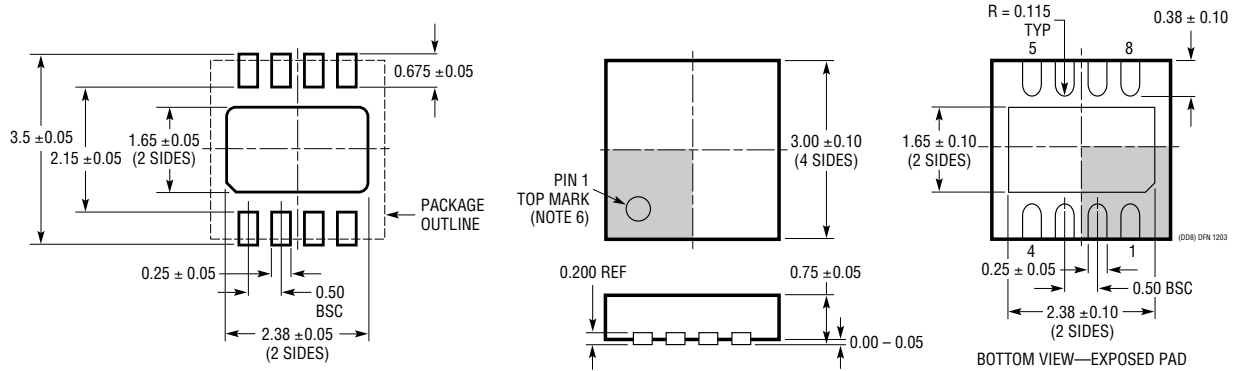

RECOMMENDED SOLDER PAD PITCH AND DIMENSIONS

NOTE:

1. DRAWING TO BE MADE A JEDEC PACKAGE OUTLINE M0-229 VARIATION OF (WEED-1)
2. DRAWING NOT TO SCALE
3. ALL DIMENSIONS ARE IN MILLIMETERS
4. DIMENSIONS OF EXPOSED PAD ON BOTTOM OF PACKAGE DO NOT INCLUDE MOLD FLASH. MOLD FLASH, IF PRESENT, SHALL NOT EXCEED 0.15mm ON ANY SIDE
5. EXPOSED PAD SHALL BE SOLDER PLATED
6. SHADED AREA IS ONLY A REFERENCE FOR PIN 1 LOCATION ON TOP AND BOTTOM OF PACKAGE

DE Package 12-Lead Plastic DFN (4mm × 3mm) (Reference LTC DWG # 05-08-1708)

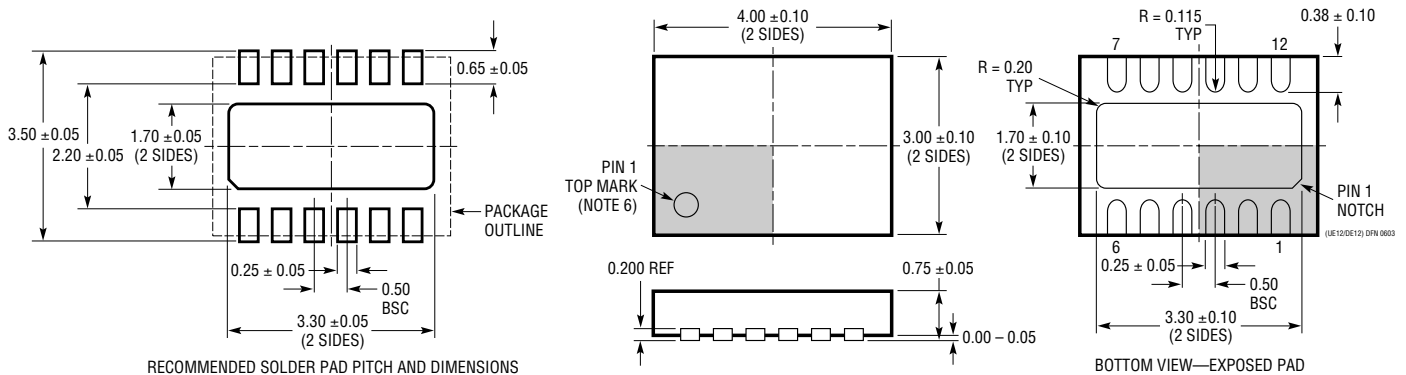

RECOMMENDED SOLDER PAD PITCH AND DIMENSIONS

NOTE:

1. DRAWING PROPOSED TO BE A VARIATION OF VERSION (WGED) IN JEDEC PACKAGE OUTLINE M0-229
2. DRAWING NOT TO SCALE
3. ALL DIMENSIONS ARE IN MILLIMETERS
4. DIMENSIONS OF EXPOSED PAD ON BOTTOM OF PACKAGE DO NOT INCLUDE MOLD FLASH. MOLD FLASH, IF PRESENT, SHALL NOT EXCEED 0.15mm ON ANY SIDE
5. EXPOSED PAD SHALL BE SOLDER PLATED
6. SHADED AREA IS ONLY A REFERENCE FOR PIN 1 LOCATION ON THE TOP AND BOTTOM OF PACKAGE

LT3473/LT3473A

TYPICAL APPLICATION

OLED Bias

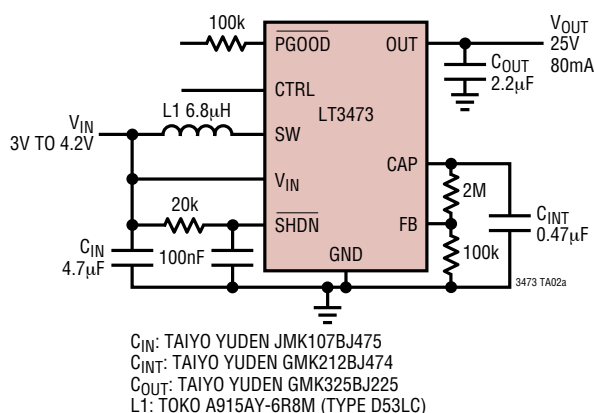

Efficiency

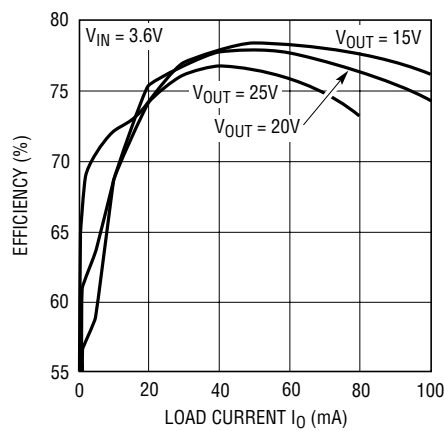

RELATED PARTS

PART NUMBER	DESCRIPTION	COMMENTS
LT1613	550mA (I_{SW}), 1.4MHz, High Efficiency Step-Up DC/DC Converter	V_{IN} : 0.9V to 10V, $V_{OUT(MAX)}$ = 34V, I_Q = 3mA, I_{SD} < 1µA, ThinSOT™ Package
LT1615/LT1615-1	300mA/80mA (I_{SW}), High Efficiency Step-Up DC/DC Converter	V_{IN} : 1V to 15V, $V_{OUT(MAX)}$ = 34V, I_Q = 20µA, I_{SD} < 1µA, ThinSOT Package
LT1930/LT1930A	1A (I_{SW}), 1.2MHz/2.2MHz, High Efficiency Step-Up DC/DC Converter	V_{IN} : 2.6V to 16V, $V_{OUT(MAX)}$ = 34V, I_Q = 4.2mA/5.5mA, I_{SD} < 1µA, ThinSOT Package
LT1935	2A (I_{SW}), 1.2MHz, High Efficiency Step-Up DC/DC Converter with Integrated Soft-Start	V_{IN} : 2.3V to 16V, $V_{OUT(MAX)}$ = 38V, I_Q = 3mA, I_{SD} < 1µA, ThinSOT Package
LT1945	Dual Output, Boost/Inverter, 350mA (I_{SW}), Constant Off-Time, High Efficiency Step-Up DC/DC Converter	V_{IN} : 1.2V to 15V, $V_{OUT(MAX)}$ = ±34V, I_Q = 40µA, I_{SD} < 1µA, 10-Lead MS Package
LT1946/LT1946A	1.5A (I_{SW}), 1.2MHz/2.7MHz, High Efficiency Step-Up DC/DC Converter	V_{IN} : 2.45V to 16V, $V_{OUT(MAX)}$ = 34V, I_Q = 3.2mA, I_{SD} < 1µA, MS8 Package
LTC®3436	3A (I_{SW}), 1MHz, 34V Step-Up DC/DC Converter	V_{IN} : 3V to 25V, $V_{OUT(MAX)}$ = 34V, I_Q = 0.9mA, I_{SD} < 6µA, TSSOP-16E Package
LT3461/LT3461A	300mA (I_{SW}), 1.3MHz/3MHz High Efficiency Step-Up DC/DC Converter with Integrated Schottky Diode	V_{IN} : 2.5V to 16V, $V_{OUT(MAX)}$ = 38V, I_Q = 2.8mA, I_{SD} < 1µA, ThinSOT Package
LT3463/LT3463A	Dual Output, Boost/Inverter, 250mA (I_{SW}), Constant Off-Time, High Efficiency Step-Up DC/DC Converters with Integrated Schottkys	V_{IN} : 2.3V to 15V, $V_{OUT(MAX)}$ = ±40V, I_Q = 40µA, I_{SD} < 1µA, DFN Package
LT3464	85mA (I_{SW}), High Efficiency Step-Up DC/DC Converter with Integrated Schottky and PNP Disconnect	V_{IN} : 2.3V to 10V, $V_{OUT(MAX)}$ = 34V, I_Q = 25µA, I_{SD} < 1µA, ThinSOT Package
LT3467/LT3467A	1.1A (I_{SW}), 1.3MHz/2.1MHz, High Efficiency Step-Up DC/DC Converter with Soft-Start	V_{IN} : 2.4V to 16V, $V_{OUT(MAX)}$ = 40V, I_Q = 1.2mA, I_{SD} < 1µA, ThinSOT Package
LT3471	Dual Output, Boost/Inverter, 1.3A (I_{SW}), 1.2MHz, High Efficiency Boost-Inverting DC/DC Converter	V_{IN} : 2.4V to 16V, $V_{OUT(MAX)}$ = ±40V, I_Q = 2.5mA, I_{SD} < 1µA, DFN Package
LT3479	3A (I_{SW}), 3.5MHz, 42V Step-Up DC/DC Converter	V_{IN} : 2.5V to 24V, $V_{OUT(MAX)}$ = 40V, I_Q = 5mA, I_{SD} < 1µA, DFN, TSSOP-16E Packages

ThinSOT is a trademark of Linear Technology Corporation.

X-ON Electronics

Largest Supplier of Electrical and Electronic Components

Click to view similar products for [Switching Voltage Regulators](#) category:

Click to view products by [Analog Devices](#) manufacturer:

Other Similar products are found below :

[FAN53610AUC33X](#) [FAN53611AUC123X](#) [FAN48610BUC33X](#) [FAN48610BUC45X](#) [FAN48617UC50X](#) [R3](#) [430464BB](#) [KE177614](#)
[FAN53611AUC12X](#) [MAX809TTR](#) [NCV891234MW50R2G](#) [NCP81103MNTXG](#) [NCP81203PMNTXG](#) [NCP81208MNTXG](#)
[NCP81109GMNTXG](#) [SCY1751FCCT1G](#) [NCP81109JMNTXG](#) [AP3409ADNTR-G1](#) [NCP81241MNTXG](#) [LTM8064IY](#) [LT8315EFE#TRPBF](#)
[LTM4664EY#PBF](#) [LTM4668AIY#PBF](#) [NCV1077CSTBT3G](#) [XCL207A123CR-G](#) [MPM54304GMN-0002](#) [MPM54304GMN-0004](#)
[MPM54304GMN-0003](#) [AP62300Z6-7](#) [MP8757GL-P](#) [MIC23356YFT-TR](#) [LD8116CGL](#) [HG2269M/TR](#) [OB2269](#) [XD3526](#) [U6215A](#) [U6215B](#)
[U6620S](#) [LTC3412IFE](#) [LT1425IS](#) [MAX25203BATJA/VY+](#) [MAX77874CEWM+](#) [XC9236D08CER-G](#) [MP3416GJ-P](#) [MP5461GC-Z](#)
[MPQ4415AGQB-Z](#) [MPQ4590GS-Z](#) [MAX38640BENT18+T](#) [MAX77511AEWB+](#) [MAX20406AFOD/VY+](#)