

High Linearity Direct Conversion Quadrature Demodulator

FEATURES

- **Input Frequency Range: 0.8GHz to 2.7GHz***
- **50Ω Single-Ended RF and LO Ports**
- **High IIP3: 28dBm at 900MHz, 22.6dBm at 1.9GHz**
- **High IIP2: 54.1dBm at 900MHz, 60dBm at 1.9GHz**
- **Input P1dB: 13.2dBm at 900MHz**
- **I/Q Gain Mismatch: 0.04dB Typical**
- **I/Q Phase Mismatch: 0.4° Typical**
- **Low Output DC Offsets**
- **Noise Figure: 12.8dB at 900MHz, 12.7dB at 1.9GHz**
- **Conversion Gain: 3dB at 900MHz, 4.2dB at 1.9GHz**
- **Very Few External Components**
- **Shutdown Mode**
- **16-Lead QFN 4mm × 4mm Package with Exposed Pad**

APPLICATIONS

- Cellular/PCS/UMTS Infrastructure
- RFID Reader
- High Linearity Direct Conversion I/Q Receiver

DESCRIPTION

The LT[®]5575 is an 800MHz to 2.7GHz direct conversion quadrature demodulator optimized for high linearity receiver applications. It is suitable for communications receivers where an RF signal is directly converted into I and Q baseband signals with bandwidth up to 490MHz. The LT5575 incorporates balanced I and Q mixers, LO buffer amplifiers and a precision, high frequency quadrature phase shifter. The integrated on-chip broadband transformers provide 50Ω single-ended interfaces at the RF and LO inputs. Only a few external capacitors are needed for its application in an RF receiver system.

The high linearity of the LT5575 provides excellent spur-free dynamic range for the receiver. This direct conversion demodulator can eliminate the need for intermediate frequency (IF) signal processing, as well as the corresponding requirements for image filtering and IF filtering. Channel filtering can be performed directly at the outputs of the I and Q channels. These outputs can interface directly to channel-select filters (LPFs) or to baseband amplifiers.

LT, LT, LTC and LTM are registered trademarks of Linear Technology Corporation. All other trademarks are the property of their respective owners.

*Operation over a wider frequency range is possible with reduced performance. Consult the factory.

TYPICAL APPLICATION

High Signal-Level I/Q Demodulator for Wireless Infrastructure

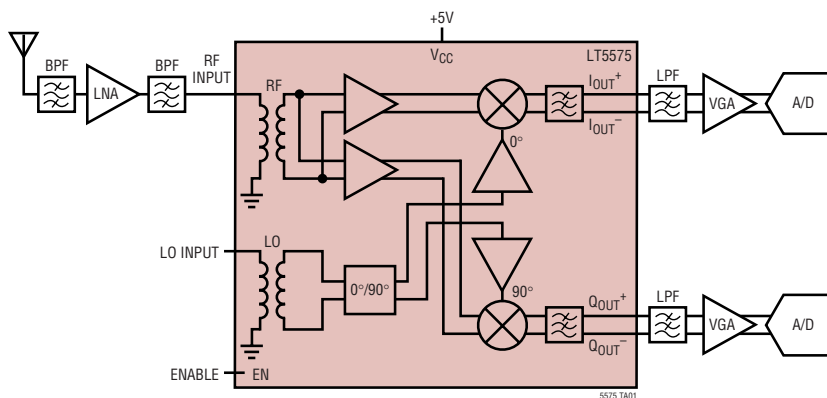

Conversion Gain, NF, IIP3 and IIP2 vs LO Input Power at 1900MHz

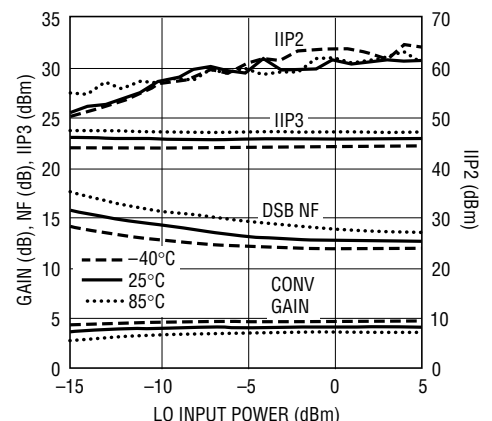

5575 TA01b

ABSOLUTE MAXIMUM RATINGS

(Note 1)

Power Supply Voltage	5.5V
Enable Voltage	-0.3V to $V_{CC} + 0.3V$
LO Input Power	10dBm
RF Input Power	20dBm
RF Input DC Voltage	$\pm 0.1V$
LO Input DC Voltage	$\pm 0.1V$
Operating Ambient Temperature	-40°C to 85°C
Storage Temperature Range	-65°C to 125°C
Maximum Junction Temperature	125°C

CAUTION: This part is sensitive to electrostatic discharge (ESD). It is very important that proper ESD precautions be observed when handling the LT5575.

PIN CONFIGURATION

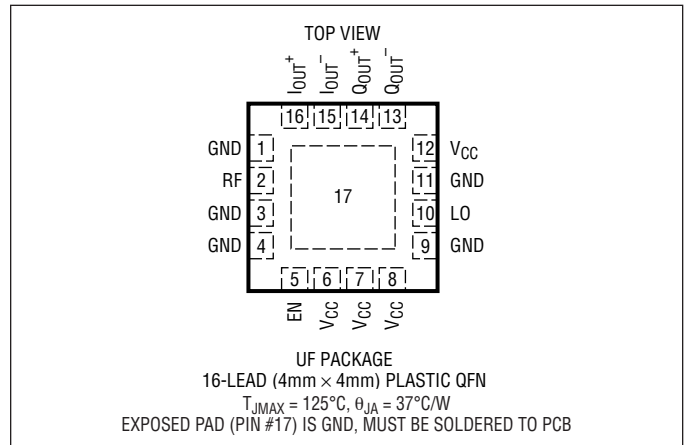

ORDER INFORMATION

LEAD FREE FINISH	TAPE AND REEL	PART MARKING	PACKAGE DESCRIPTION	TEMPERATURE RANGE
LT5575EUF#PBF	LT5575EUF#TRPBF	5575	16-Lead (4mm x 4mm) QFN	-40°C to 85°C

Consult LTC Marketing for parts specified with wider operating temperature ranges.
 Consult LTC Marketing for information on nonstandard lead based finish parts.

For more information on lead free part marking, go to: <http://www.linear.com/leadfree/>
 For more information on tape and reel specifications, go to: <http://www.linear.com/tapeandreel/>

DC ELECTRICAL CHARACTERISTICS $V_{CC} = +5V$, $T_A = 25^{\circ}C$, unless otherwise noted. (Note 3)

PARAMETER	CONDITIONS	MIN	TYP	MAX	UNITS
Supply Voltage		4.5		5.25	V
Supply Current			132	155	mA
Shutdown Current	EN = Low		< 1	100	μA
Turn On Time			120		ns
Turn Off Time			750		ns
EN = High (On)		2			V
EN = Low (Off)				1	V
EN Input Current	$V_{ENABLE} = 5V$		120		μA
Output DC Offset Voltage ($ I_{OUT+} - I_{OUT-} $, $ Q_{OUT+} - Q_{OUT-} $)	$f_{LO} = 1900MHz$, $P_{LO} = 0dBm$		< 9		mV
Output DC Offset Variation vs Temperature	-40°C to 85°C		38		$\mu V/^{\circ}C$

AC ELECTRICAL CHARACTERISTICS Test circuit shown in Figure 1. (Notes 2, 3)

PARAMETER	CONDITIONS	MIN	TYP	MAX	UNITS
RF Input Frequency Range	No External Matching (High Band)		1.5 to 2.7		GHz
	With External Matching (Low Band, Mid Band)		0.8 to 1.5		GHz
LO Input Frequency Range	No External Matching (High Band)		1.5 to 2.7		GHz
	With External Matching (Low Band, Mid Band)		0.8 to 1.5		GHz
Baseband Frequency Range			DC to 490		MHz
Baseband I/Q Output Impedance	Single-Ended		65Ω// 5pF		
RF Input Return Loss	$Z_0 = 50\Omega$, 1.5GHz to 2.7GHz, Internally Matched		>10		dB
LO Input Return Loss	$Z_0 = 50\Omega$, 1.5GHz to 2.7GHz, Internally Matched		>10		dB
LO Input Power			-13 to 5		dBm

AC ELECTRICAL CHARACTERISTICS $V_{CC} = +5V$, EN = High, $T_A = 25^\circ C$, $P_{RF} = -10dBm$ (-10dBm/tone for 2-tone IIP2 and IIP3 tests), Baseband Frequency = 1MHz (0.9MHz and 1.1MHz for 2-tone tests), $P_{LO} = 0dBm$, unless otherwise noted. (Notes 2, 3, 6)

PARAMETER	CONDITIONS	MIN	TYP	MAX	UNITS
Conversion Gain	Voltage Gain, $R_{LOAD} = 1k\Omega$				
	$R_F = 900MHz$ (Note 5)		3		dB
	$R_F = 1900MHz$		4.2		dB
	$R_F = 2100MHz$		3.5		dB
	$R_F = 2500MHz$		2		dB
Noise Figure (Double-Side Band, Note 4)	$R_F = 900MHz$ (Note 5)		12.8		dB
	$R_F = 1900MHz$		12.7		dB
	$R_F = 2100MHz$		13.6		dB
	$R_F = 2500MHz$		15.7		dB
	Input 3rd-Order Intercept	$R_F = 900MHz$ (Note 5)		28	
$R_F = 1900MHz$			22.6		dBm
$R_F = 2100MHz$			22.7		dBm
$R_F = 2500MHz$			23.3		dBm
Input 2nd-Order Intercept		$R_F = 900MHz$ (Note 5)		54.1	
	$R_F = 1900MHz$		60		dBm
	$R_F = 2100MHz$		56		dBm
	$R_F = 2500MHz$		52.3		dBm
	Input 1dB Compression	$R_F = 900MHz$ (Note 5)		13.2	
$R_F = 1900MHz$			11.2		dBm
$R_F = 2100MHz$			11		dBm
$R_F = 2500MHz$			12.3		dBm
I/Q Gain Mismatch		$R_F = 900MHz$ (Note 5)		0.03	
	$R_F = 1900MHz$		0.01		dB
	$R_F = 2100MHz$		0.04		dB
	$R_F = 2500MHz$		0.04		dB
	I/Q Phase Mismatch	$R_F = 900MHz$ (Note 5)		0.5	
$R_F = 1900MHz$			0.4		°
$R_F = 2100MHz$			0.6		°
$R_F = 2500MHz$			0.2		°
LO to RF Leakage		$R_F = 900MHz$ (Note 5)		-60.8	
	$R_F = 1900MHz$		-64.6		dBm
	$R_F = 2100MHz$		-60.2		dBm
	$R_F = 2500MHz$		-51.2		dBm

5575f

AC ELECTRICAL CHARACTERISTICS $V_{CC} = +5V$, EN = High, $T_A = 25^\circ C$, $P_{RF} = -10dBm$ ($-10dBm/$ tone for 2-tone IIP2 and IIP3 tests), Baseband Frequency = 1MHz (0.9MHz and 1.1MHz for 2-tone tests), $P_{LO} = 0dBm$, unless otherwise noted. (Notes 2, 3, 6)

PARAMETER	CONDITIONS	MIN	TYP	MAX	UNITS
RF to LO Isolation	$R_F = 900MHz$ (Note 5)		59.7		dBc
	$R_F = 1900MHz$		57.1		dBc
	$R_F = 2100MHz$		59.5		dBc
	$R_F = 2500MHz$		53.1		dBc

Note 1: Stresses beyond those listed under Absolute Maximum Ratings may cause permanent damage to the device. Exposure to any Absolute Maximum Rating condition for extended periods may affect device reliability and lifetime.

Note 2: Tests are performed as shown in the configuration of Figure 1.

Note 3: Specifications over the $-40^\circ C$ to $85^\circ C$ temperature range are assured by design, characterization and correlation with statistical process control.

Note 4: DSB Noise Figure is measured with a small-signal noise source at the baseband frequency of 15MHz without any filtering on the RF input and no other RF signal applied.

Note 5: 900MHz performance is measured with external RF and LO matching. The optional output capacitors C1-C4 (10pF) are also used for best IIP2 performance.

Note 6: For these measurements, the complementary outputs (e.g., I_{OUT+} , I_{OUT-}) were combined using a 180° phase shift combiner.

Note 7: Large-signal noise figure is measured at an output frequency of 198.7MHz with RF input signal at $f_{LO} - 1MHz$. Both RF and LO input signals are appropriately bandpass filtered, as well as baseband output.

TYPICAL AC PERFORMANCE CHARACTERISTICS $V_{CC} = 5V$, EN = High, $T_A = 25^\circ C$, $P_{RF} = -10dBm$ (-10dBm/tone for 2-tone IIP2 and IIP3 tests), $f_{BB} = 1MHz$ (0.9MHz and 1.1MHz for 2-tone tests), $P_{LO} = 0dBm$, unless otherwise noted. Test Circuit Shown in Figure 1 (Note 6).

Conversion Gain, NF and IIP3 vs Frequency

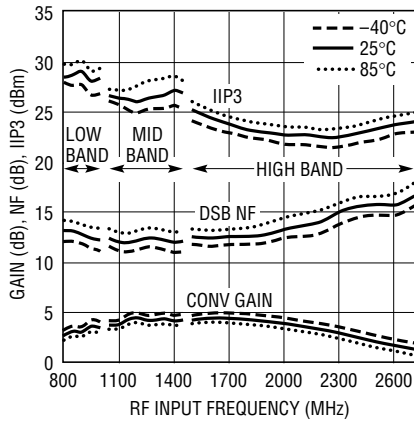

5575 G01

IIP2 vs Frequency

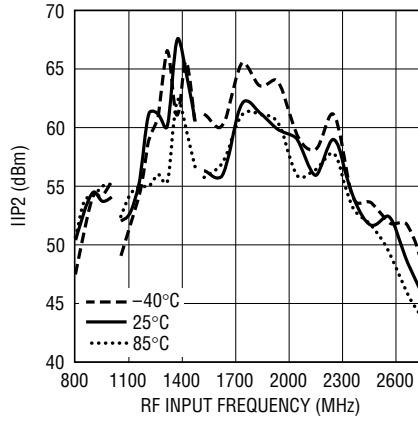

5575 G02

Supply Current vs Supply Voltage

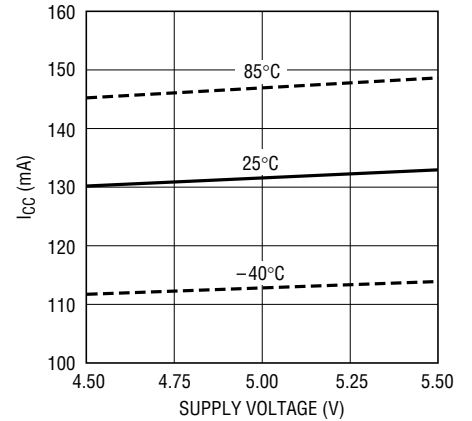

5575 G03

Conversion Gain vs RF Input Power

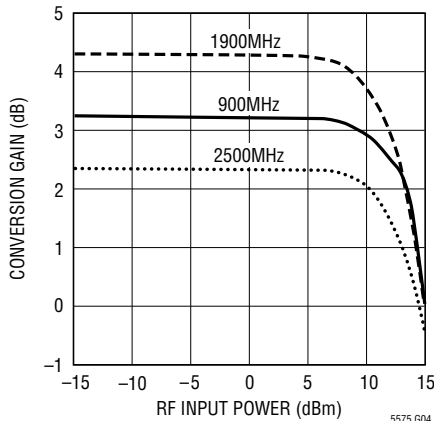

5575 G04

I/Q Gain Mismatch vs RF Input Frequency

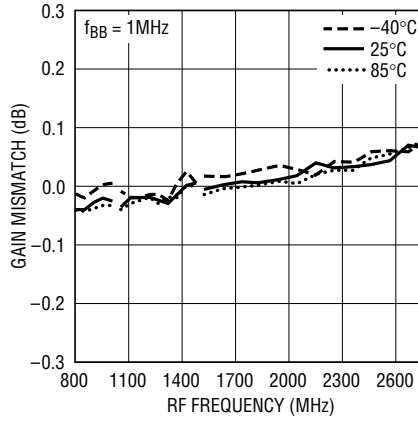

5575 G05

I/Q Phase Mismatch vs RF Input Frequency

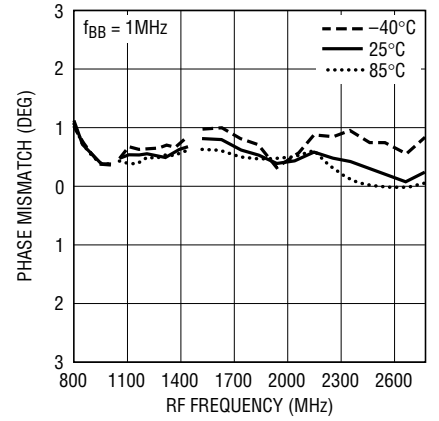

5575 G06

RF-LO Isolation vs RF Input Power

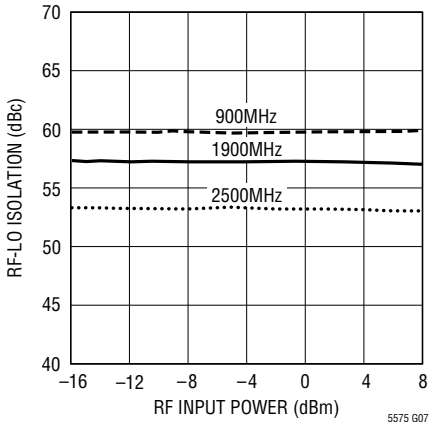

5575 G07

LO-RF Leakage vs LO Input Power

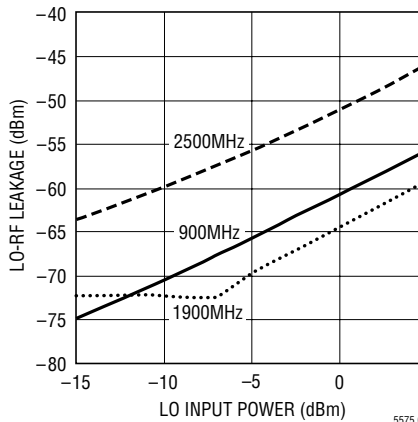

5575 G08

Conversion Gain vs Baseband Frequency

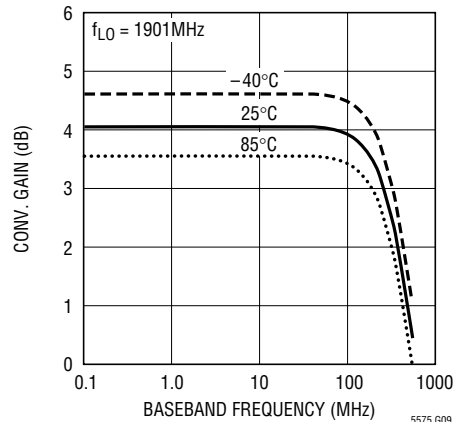

5575 G09

5575f

TYPICAL AC PERFORMANCE CHARACTERISTICS $V_{CC} = 5V$, $EN = High$, $T_A = 25^\circ C$, $P_{RF} = -10dBm$ (-10dBm/tone for 2-tone IIP2 and IIP3 tests), $f_{BB} = 1MHz$ (0.9MHz and 1.1MHz for 2-tone tests), $P_{LO} = 0dBm$, unless otherwise noted. Test Circuit Shown in Figure 1 (Note 6).

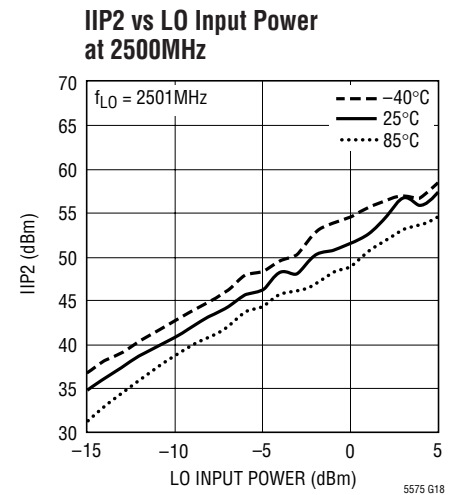
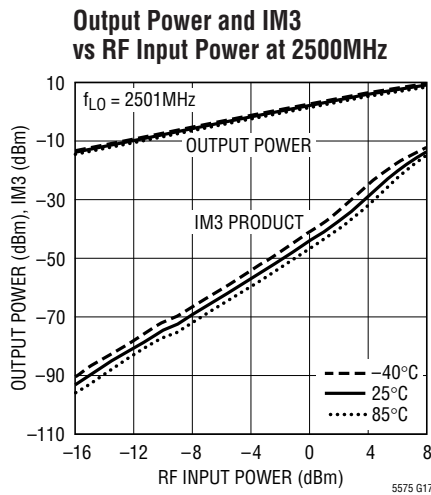
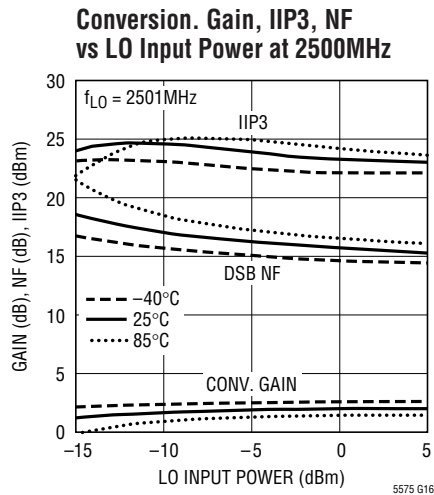
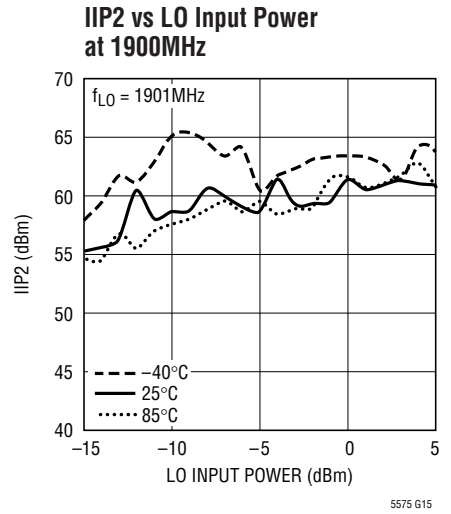
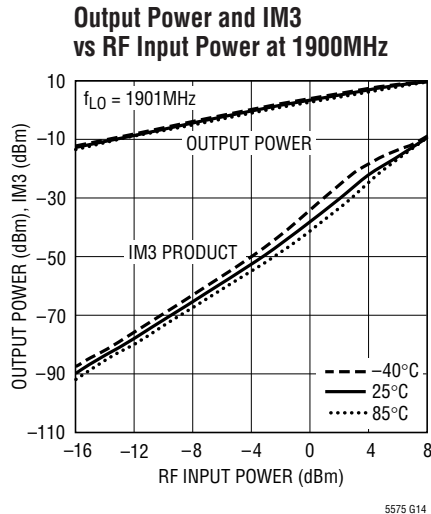
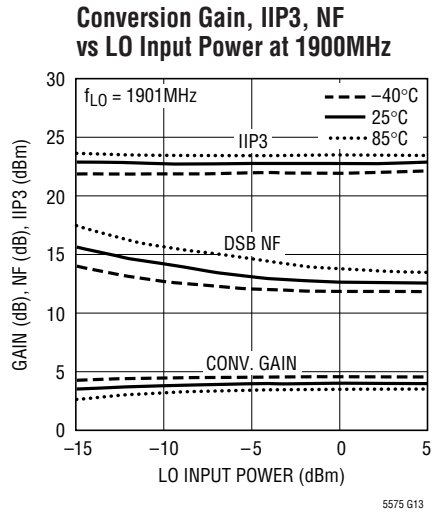
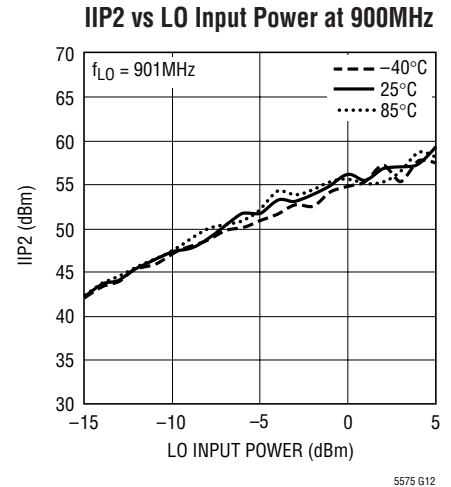
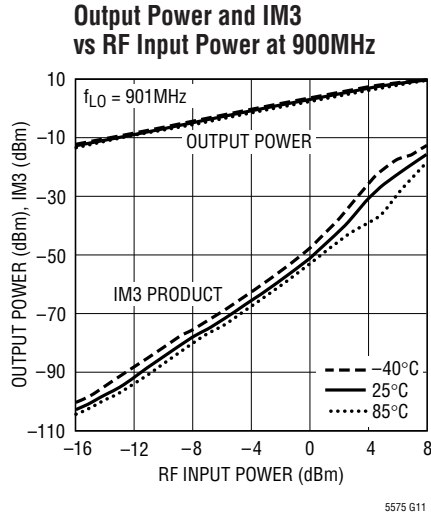
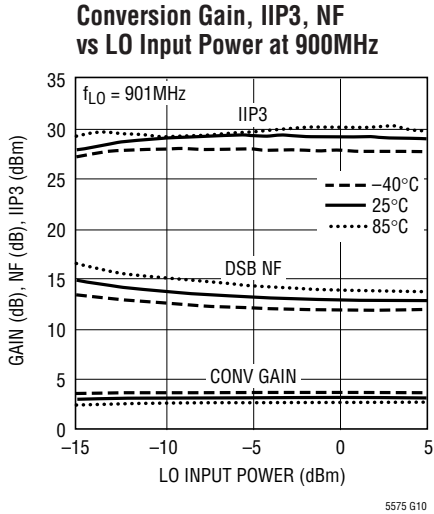

TYPICAL AC PERFORMANCE CHARACTERISTICS $V_{CC} = 5V$, $EN = High$, $T_A = 25^\circ C$, $P_{RF} = -10dBm$ ($-10dBm/$ tone for 2-tone IIP2 and IIP3 tests), $f_{BB} = 1MHz$ (0.9MHz and 1.1MHz for 2-tone tests), $P_{LO} = 0dBm$, unless otherwise noted. Test Circuit Shown in Figure 1 (Notes 6, 7).

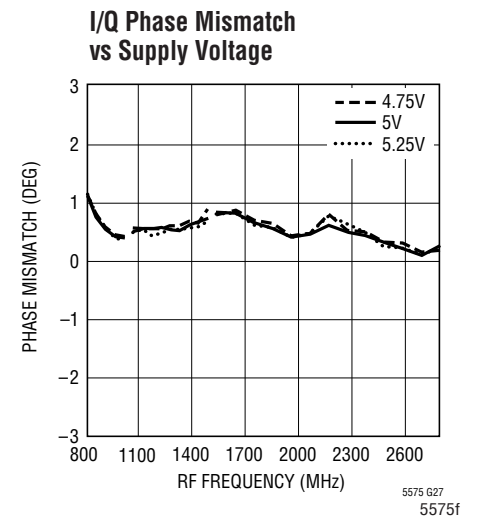
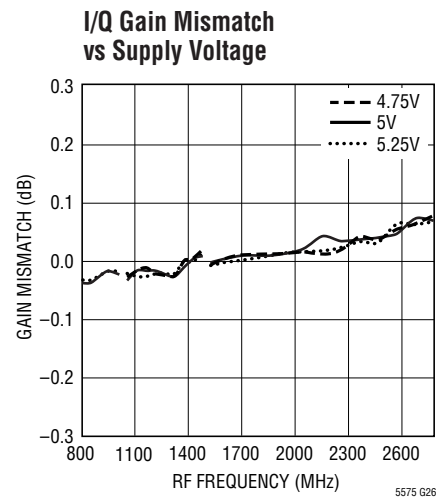
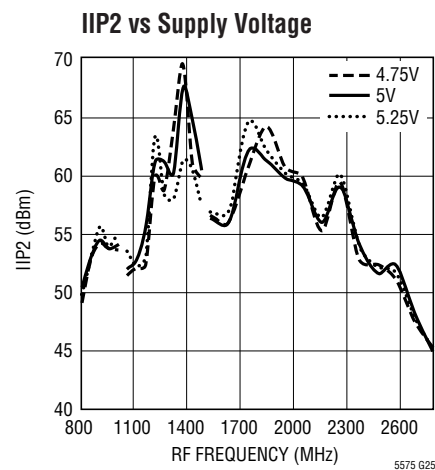
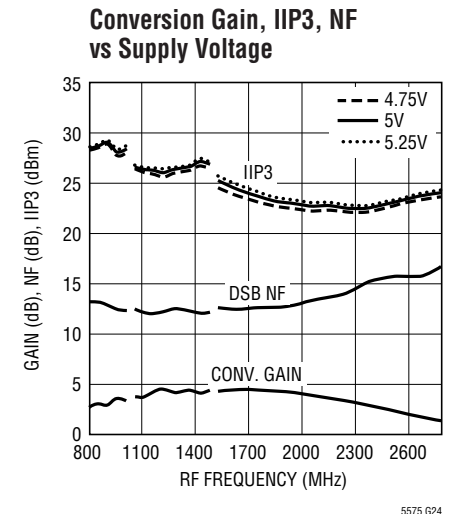
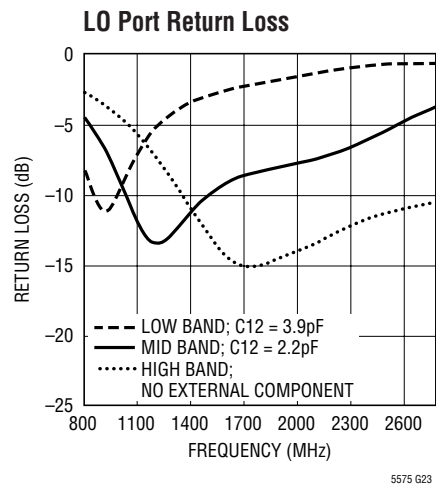
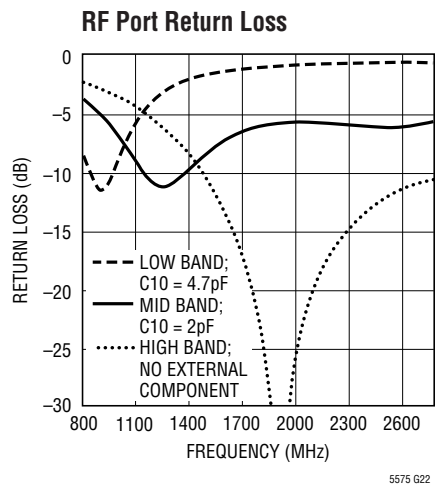
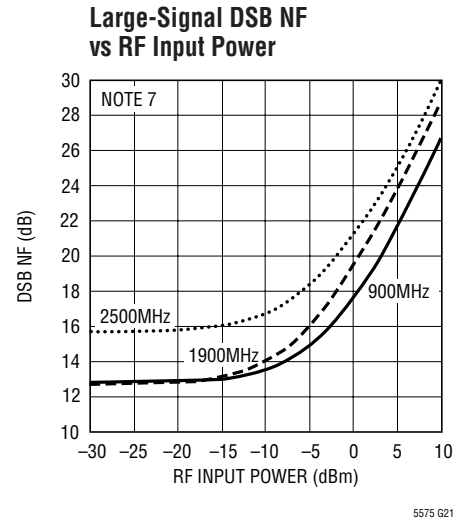
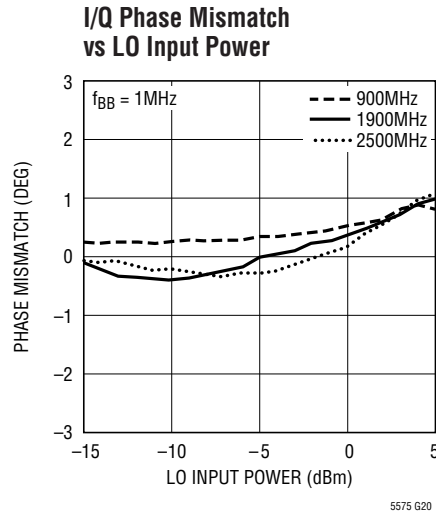
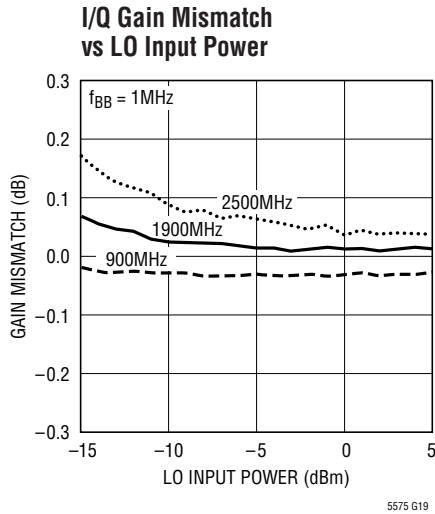

TYPICAL AC PERFORMANCE CHARACTERISTICS $V_{CC} = 5V$, $EN = High$, $T_A = 25^\circ C$, $P_{RF} = -10dBm$ (-10dBm/tone for 2-tone IIP2 and IIP3 tests), $f_{BB} = 1MHz$ (0.9MHz and 1.1MHz for 2-tone tests), $P_{LO} = 0dBm$, unless otherwise noted. Test Circuit Shown in Figure 1 (Note 6).

Conversion Gain Distribution at 1900MHz

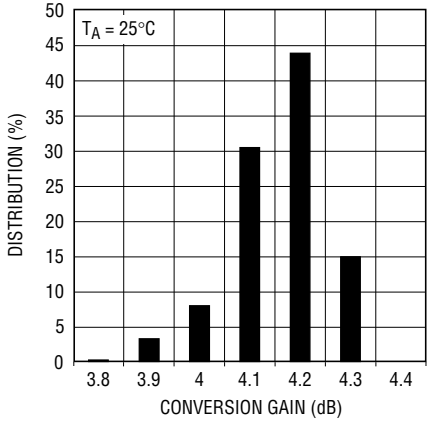

5575 G28

IIP3 Distribution at 1900MHz vs Temperature

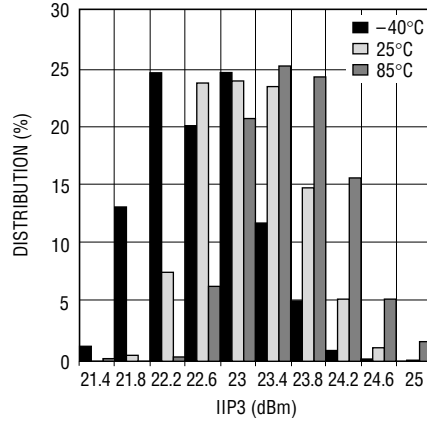

5575 G29

Noise Figure Distribution at 1900MHz

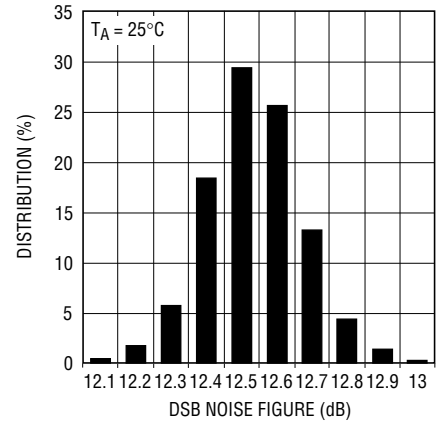

5575 G30

I/Q Amplitude Mismatch Distribution at 1900MHz vs Temperature

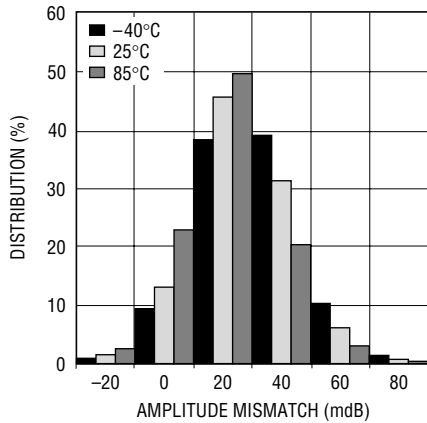

5575 G31

I/Q Phase Mismatch Distribution at 1900MHz vs Temperature

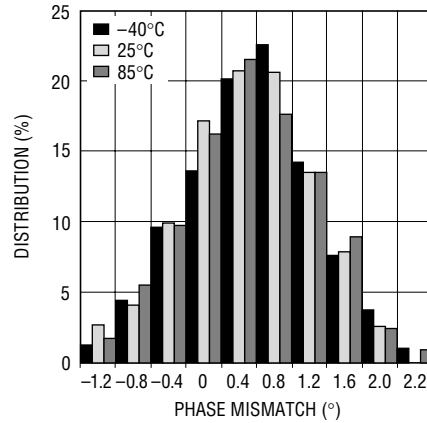

5575 G32

I-Output DC Offset Voltage Distribution vs Temperature

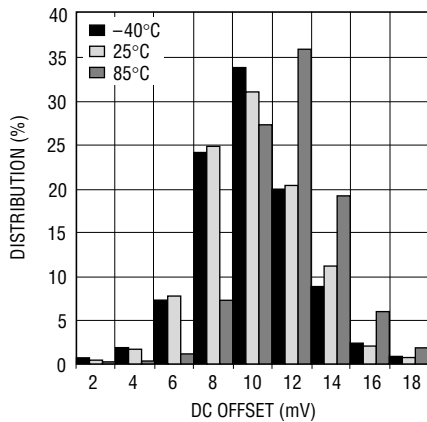

5575 G33

Q-Output DC Offset Voltage Distribution vs Temperature

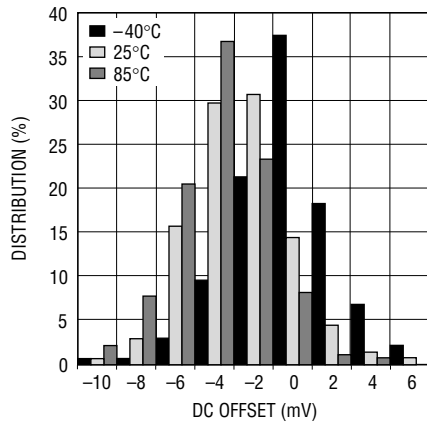

5575 G34

PIN FUNCTIONS

GND (Pins 1, 3, 4, 9, 11): Ground pin.

RF (Pin 2): RF Input Pin. This is a single-ended 50Ω terminated input. No external matching network is required for the high frequency band. An external series capacitor (and/or shunt capacitor) may be required for impedance transformation to 50Ω in the low frequency band from 800MHz to 1.5GHz (see Figure 4). If the RF source is not DC blocked, a series blocking capacitor should be used. Otherwise, damage to the IC may result.

V_{CC} (Pins 6, 7, 8, 12): Power Supply Pins. These pins should be decoupled using 1000pF and 0.1μF capacitors.

EN (Pin 5): Enable Pin. When the input voltage is higher than 2.0V, the circuit is completely turned on. When the enable pin voltage is less than 1.0V, the circuit is turned off. Under no conditions should the voltage at the EN pin exceed V_{CC} + 0.3V. Otherwise, damage to the IC may result. If the Enable function is not needed, then the EN pin should be tied to V_{CC}.

LO (Pin 10): Local Oscillator Input Pin. This is a single-ended 50Ω terminated input. No external matching network is required in the high frequency band. An external shunt capacitor (and/or series capacitor) may be required for impedance transformation to 50Ω for the low frequency band from 800MHz to 1.5GHz (see Figure 6). If the LO source is not DC blocked, a series blocking capacitor must be used. Otherwise, damage to the IC may result.

Q_{OUT}⁻, Q_{OUT}⁺ (Pins 13, 14): Differential Baseband Output Pins of the Q Channel. The internal DC bias voltage is V_{CC} – 1.1V for each pin.

I_{OUT}⁻, I_{OUT}⁺ (Pins 15, 16): Differential Baseband Output Pins of the I Channel. The internal DC bias voltage is V_{CC} – 1.1V for each pin.

Exposed Pad (Pin 17): Ground Return for the Entire IC. This pin must be soldered to the printed circuit board ground plane.

BLOCK DIAGRAM

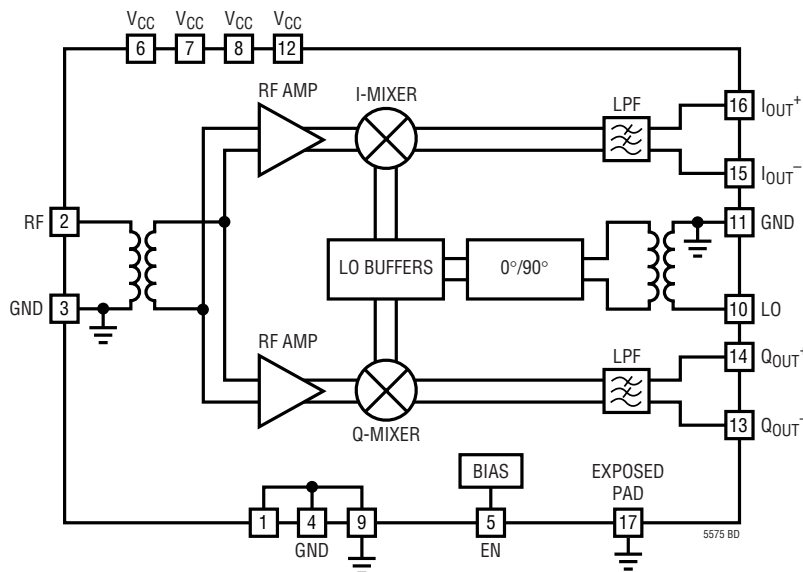

TEST CIRCUIT

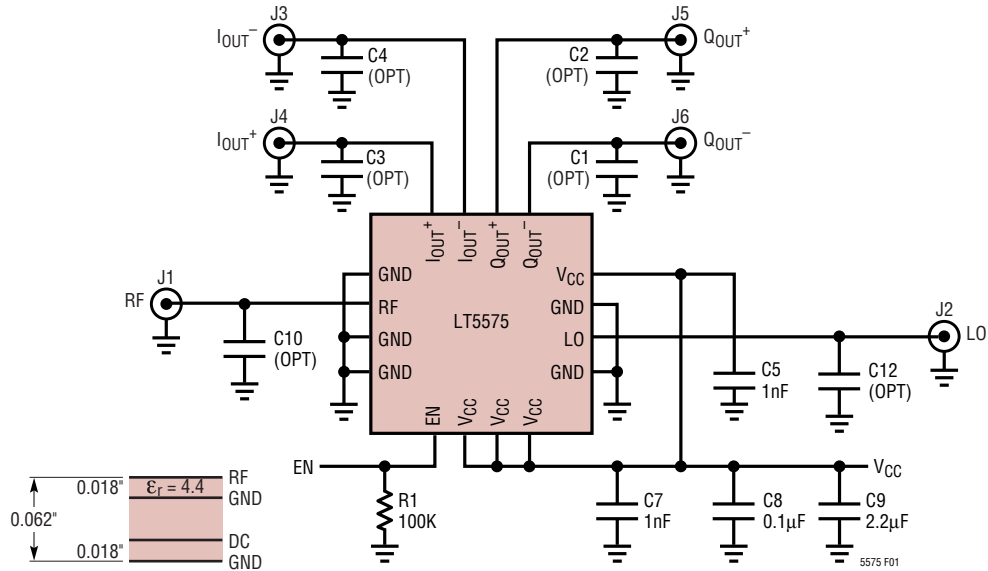

REF DES	VALUE	SIZE	PART NUMBER
C5, C7	1000pF	0402	AVX 04025C102JAT
C8	0.1µF	0402	AVX 0402ZD104KAT
C9	2.2µF	3216	AVX TPSA225M010R1800
R1	100kΩ	0402	

FREQUENCY RANGE	RF MATCH	LO MATCH	BASEBAND
		C10	C12
LOW BAND: 800 TO 1000MHz	4.7pF	3.9pF	10pF
MID BAND: 1000 TO 1500MHz	2pF	2pF	2.2pF
HIGH BAND: 1500 TO 2700MHz	-	-	-

Figure 1. Evaluation Circuit Schematic

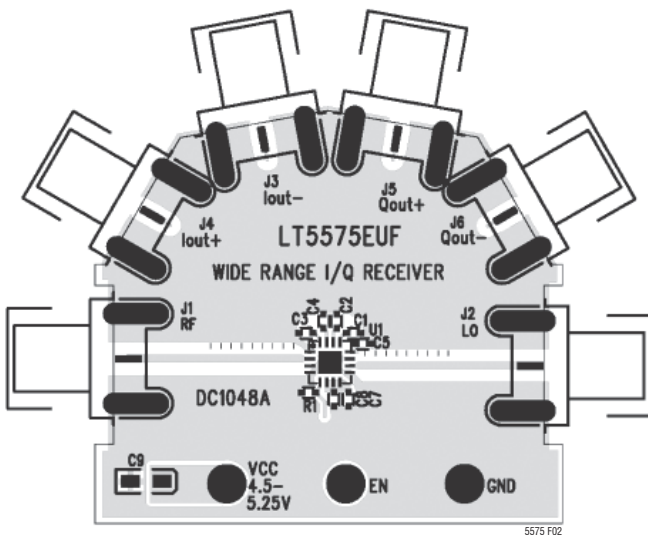

Figure 2. Top Side of Evaluation Board

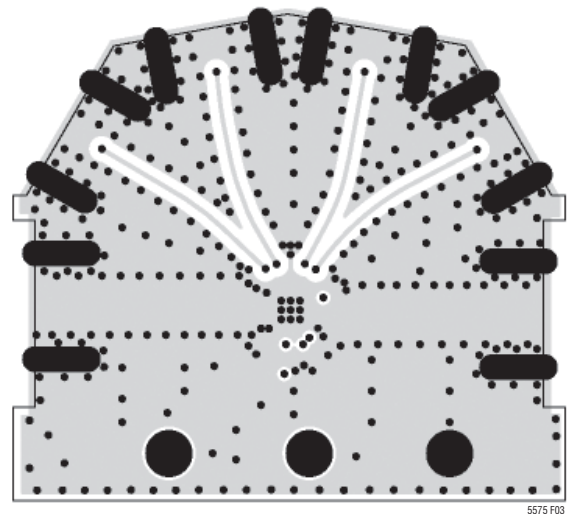

Figure 3. Bottom Side of Evaluation Board

APPLICATIONS INFORMATION

The LT5575 is a direct I/Q demodulator targeting high linearity receiver applications, such as RFID readers and wireless infrastructure. It consists of RF transconductance amplifiers, I/Q mixers, a quadrature LO phase shifter, and bias circuitry.

The RF signal is applied to the inputs of the RF transconductance amplifiers and is then demodulated into I/Q baseband signals using quadrature LO signals which are internally generated from an external LO source by precision 90° phase-shifters. The demodulated I/Q signals are single-pole low-pass filtered on-chip with a -3dB bandwidth of 490MHz. The differential outputs of the I-channel and Q-channel are well matched in amplitude; their phases are 90° apart.

Broadband transformers are integrated on-chip at both the RF and LO inputs to enable single-ended RF and LO interfaces. In the high frequency band (1.5GHz to 2.7GHz), both RF and LO ports are internally matched to 50Ω. No external matching components are needed. For the lower frequency bands (800MHz to 1.5GHz), a simple network with series and/or shunt capacitors can be used as the impedance matching network.

RF Input Port

Figure 4 shows the demodulator's RF input which consists of an integrated transformer and high linearity transconductance amplifiers. The primary side of the transformer is connected to the RF input pin. The secondary side of the transformer is connected to the differential inputs of the transconductance amplifiers. Under no circumstances should an external DC voltage be applied to the RF input pin. DC current flowing into the primary side of the transformer may cause damage to the integrated transformer. A series blocking capacitor should be used to AC-couple the RF input port to the RF signal source.

The RF input port is internally matched over a wide frequency range from 1.5GHz to 2.7GHz with input return loss typically better than 10dB. No external matching network is needed for this frequency range. When the part is operated at lower frequencies, however, the input return loss can be improved with the matching network shown in Figure 4. Shunt capacitor C10 and series capacitor C11 can be selected for optimum input impedance matching at the

desired frequency as illustrated in Figure 5. For lower frequency band operation, the external matching component C11 can serve as a series DC blocking capacitor.

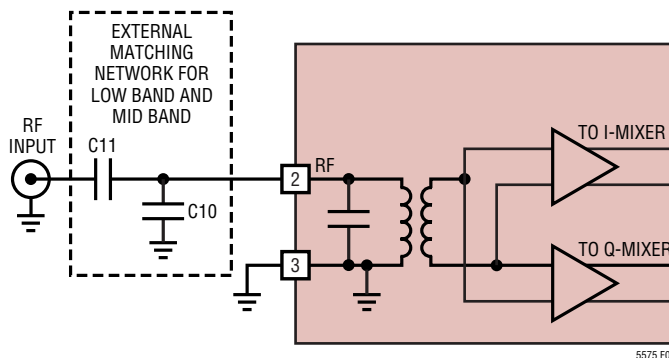

Figure 4. RF Input Interface

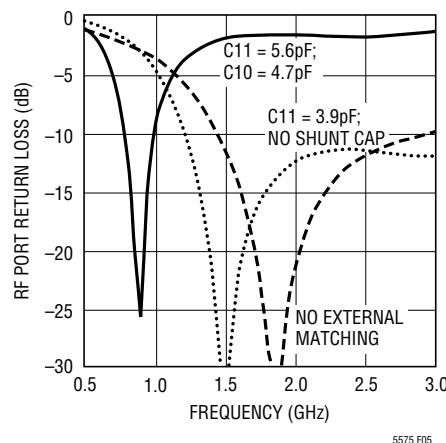

Figure 5. RF Input Return Loss with External Matching

APPLICATIONS INFORMATION

The RF input impedance and S11 parameters (without external matching components) are listed in Table 1.

Table 1. RF Input Impedance

FREQUENCY (GHz)	INPUT IMPEDANCE (Ω)	S11	
		MAG	ANGLE ($^{\circ}$)
0.8	8.1 +j 21.3	0.760	133.0
0.9	10.5 +j 24.9	0.715	125.4
1.0	13.8 +j 28.8	0.660	117.2
1.1	18.6 +j 32.5	0.595	108.6
1.2	25.2 +j 35.5	0.521	99.6
1.3	33.6 +j 36.8	0.441	90.3
1.4	43.1 +j 34.6	0.355	80.8
1.5	51.4 +j 28.4	0.270	71.6
1.6	55.8 +j 19.3	0.188	63
1.7	55.4 +j 10.4	0.110	56.9
1.8	51.8 +j 3.9	0.042	63
1.9	46.9 +j 0.4	0.032	172.7
2.0	42.3 +j -0.8	0.084	-173.9
2.1	38.4 +j -0.3	0.131	-178.2
2.2	35.4 +j 1	0.172	175.3
2.3	33 +j 2.9	0.207	168.4
2.4	31.5 +j 4.9	0.235	161.9
2.5	30.4 +j 7	0.258	155.4
2.6	29.9 +j 9.1	0.274	149.2
2.7	29.7 +j 11.1	0.287	143.4

LO Input Port

The demodulator’s LO input interface is shown in Figure 6. The input consists of an integrated transformer and a precision quadrature phase shifter which generates 0° and 90° phase-shifted LO signals for the LO buffer amplifiers driving the I/Q mixers. The primary side of the transformer is connected to the LO input pin. The secondary side of the transformer is connected to the differential inputs of the LO quadrature generator. Under no circumstances should an external DC voltage be applied to the input pin. DC current flowing into the primary side of the transformer may damage the transformer. A series blocking capacitor should be used to AC-couple the LO input port to the LO signal source.

The LO input port is internally matched over a wide frequency range from 1.5GHz to 2.7GHz with input return loss typically better than 10dB. No external matching network is needed for this frequency range. When the part is operated at a lower frequency, the input return loss can be improved with the matching network shown in Figure 6. Shunt capacitor C12 and series capacitor C13 can be selected for optimum input impedance matching at the desired frequency as illustrated in Figure 7. For lower frequency operation, external matching component C13 can serve as the series DC blocking capacitor.

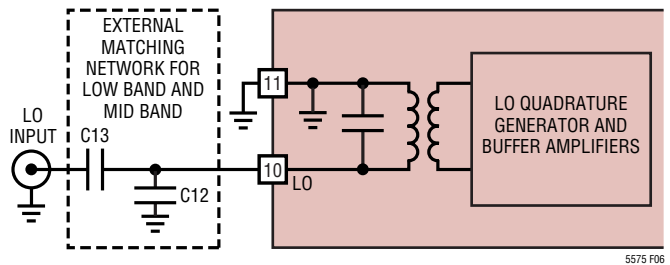

Figure 6. LO Input Interface

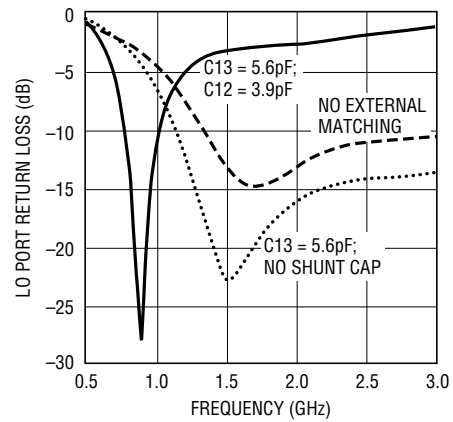

Figure 7. LO Input Return Loss with External Matching

APPLICATIONS INFORMATION

The LO input impedance and S11 parameters (without external matching components) are listed in Table 2.

Table 2. LO Input Impedance

FREQUENCY (GHz)	INPUT IMPEDANCE (Ω)	S11	
		MAG	ANGLE ($^{\circ}$)
0.8	9.6 + j 23.7	0.731	127.9
0.9	13 + j 27.1	0.669	120.4
1.0	17.9 + j 30	0.592	113.2
1.1	24.1 + j 31.7	0.508	106.1
1.2	31.2 + j 31.4	0.421	99.8
1.3	37.5 + j 28.9	0.341	95.1
1.4	41.9 + j 24.6	0.272	93.4
1.5	43.4 + j 20	0.221	96.2
1.6	42.9 + j 16.4	0.189	103.5
1.7	41.2 + j 14.1	0.18	113.1
1.8	39.5 + j 13.1	0.186	120.3
1.9	37.8 + j 13.1	0.201	124.5
2.0	36.6 + j 13.6	0.217	125.6
2.1	35.6 + j 14.6	0.236	125
2.2	35.1 + j 15.7	0.25	123.1
2.3	34.9 + j 17.1	0.264	120.1
2.4	35.1 + j 18.5	0.272	116.6
2.5	35.5 + j 19.9	0.281	113
2.6	36.3 + j 21.2	0.284	109
2.7	37.2 + j 22.5	0.287	105.1

I-Channel and Q-Channel Outputs

Each of the I-channel and Q-channel outputs is internally connected to V_{CC} through a 65Ω resistor. The output DC bias voltage is $V_{CC} - 1.1V$. The outputs can be DC-coupled or AC-coupled to the external loads. Each single-ended output has an impedance of 65Ω in parallel with a $5pF$ internal capacitor, forming a low-pass filter with a $-3dB$ corner frequency at $490MHz$. The loading resistance on each output, R_{LOAD} (single-ended), should be larger than 300Ω to assure full gain. The gain is reduced by $20 \cdot \log_{10}(1 + 65\Omega/R_{LOAD})$ in dB when the output port is terminated by R_{LOAD} . For instance, the gain is reduced by $7.23dB$ when each output pin is connected to a 50Ω load (or 100Ω differentially). The output should be taken differentially (or by using differential-to-single-ended conversion) for best RF performance, including NF and IM2.

The phase relationship between the I-channel output signal and the Q-channel output signal is fixed. When the LO input frequency is larger (or smaller) than the RF input frequency, the Q-channel outputs (Q_{OUT}^+ , Q_{OUT}^-) lead (or lag) the I-channel outputs (I_{OUT}^+ , I_{OUT}^-) by 90° .

When AC output coupling is used, the resulting high-pass filter's $-3dB$ roll-off frequency is defined by the RC constant of the blocking capacitor and R_{LOAD} , assuming $R_{LOAD} \gg 65\Omega$.

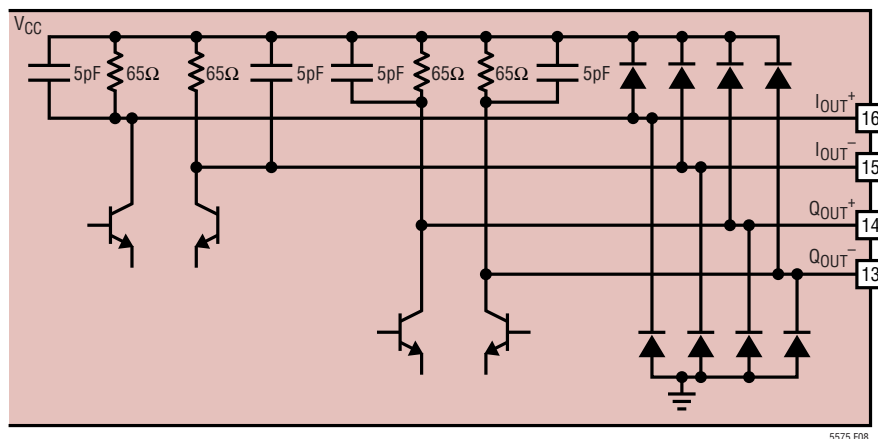

Figure 8. I/Q Output Equivalent Circuit

APPLICATIONS INFORMATION

Care should be taken when the demodulator's outputs are DC-coupled to the external load to make sure that the I/Q mixers are biased properly. If the current drain from the outputs exceeds 6mA, there can be significant degradation of the linearity performance. Each output can sink no more than 16.8mA when the outputs are connected to an external load with a DC voltage higher than $V_{CC} - 1.1V$. The I/Q output equivalent circuit is shown in Figure 8.

In order to achieve best IIP2 performance, it is important to minimize high frequency coupling among the baseband outputs, RF port and LO port. For a multilayer PCB layout design, the metal lines of the baseband outputs should be placed on the backside of the PCB as shown in Figures 2 and 3. Typically, output shunt capacitors C1-C4 are not required for the application near 1900MHz. However, for other frequency bands, these capacitors can be optimized for best IIP2 performance. For example, when the operating frequency is 900MHz, the IIP2 can be improved to 54dBm or better when 10pF shunt capacitors are placed at each output.

Enable Interface

A simplified schematic of the EN pin is shown in Figure 9. The enable voltage necessary to turn on the LT5575 is 2V. To disable or turn off the chip, this voltage should be below 1V. If the EN pin is not connected, the chip is disabled. However, it is not recommended that the pin be left floating for normal operation.

It is important that the voltage applied to the EN pin should never exceed V_{CC} by more than 0.3V. Otherwise, the supply current may be sourced through the upper ESD protection diode connected at the EN pin. Under no circumstances should voltage be applied to the EN pin before the supply voltage is applied to the V_{CC} pin. If this occurs, damage to the IC may result.

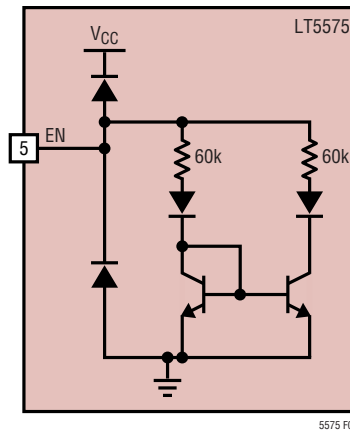
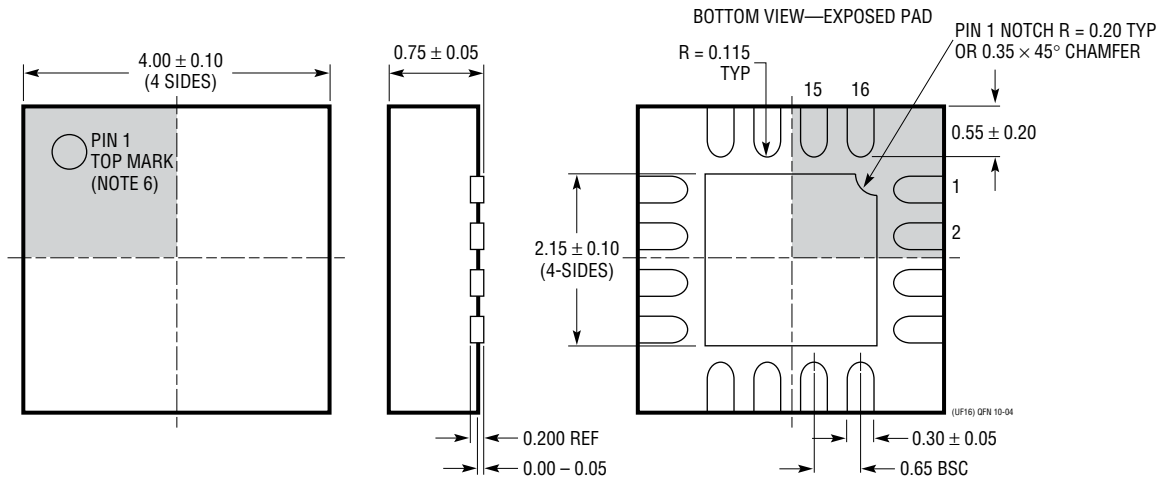
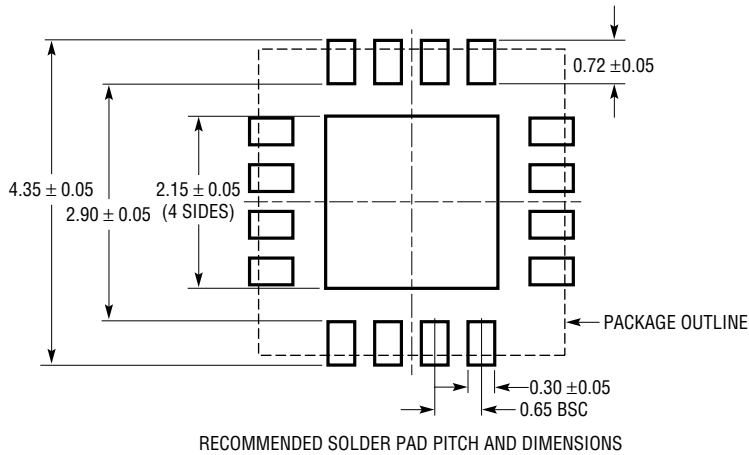

Figure 9. Enable Pin Simplified Circuit

PACKAGE DESCRIPTION

UF Package
16-Lead Plastic QFN (4mm × 4mm)
 (Reference LTC DWG # 05-08-1692)



- NOTE:
1. DRAWING CONFORMS TO JEDEC PACKAGE OUTLINE MO-220 VARIATION (WGFC)
 2. DRAWING NOT TO SCALE
 3. ALL DIMENSIONS ARE IN MILLIMETERS
 4. DIMENSIONS OF EXPOSED PAD ON BOTTOM OF PACKAGE DO NOT INCLUDE MOLD FLASH. MOLD FLASH, IF PRESENT, SHALL NOT EXCEED 0.15mm ON ANY SIDE
 5. EXPOSED PAD SHALL BE SOLDER PLATED
 6. SHADED AREA IS ONLY A REFERENCE FOR PIN 1 LOCATION ON THE TOP AND BOTTOM OF PACKAGE

RELATED PARTS

PART NUMBER	DESCRIPTION	COMMENTS
Infrastructure		
LT5514	Ultralow Distortion, IF Amplifier/ADC Driver with Digitally Controlled Gain	850MHz Bandwidth, 47dBm OIP3 at 100MHz, 10.5dB to 33dB Gain Control Range
LT5515	1.5GHz to 2.5GHz Direct Conversion Quadrature Demodulator	20dBm IIP3, Integrated LO Quadrature Generator
LT5516	0.8GHz to 1.5GHz Direct Conversion Quadrature Demodulator	21.5dBm IIP3, Integrated LO Quadrature Generator
LT5517	40MHz to 900MHz Quadrature Demodulator	21dBm IIP3, Integrated LO Quadrature Generator
LT5518	1.5GHz to 2.4GHz High Linearity Direct Quadrature Modulator	22.8dBm OIP3 at 2GHz, -158.2dBm/Hz Noise Floor, 50Ω Single-Ended RF and LO Ports, 4-Channel W-CDMA ACPR = -64dBc at 2.14GHz
LT5519	0.7GHz to 1.4GHz High Linearity Upconverting Mixer	17.1dBm IIP3 at 1GHz, Integrated RF Output Transformer with 50Ω Matching, Single-Ended LO and RF Ports Operation
LT5520	1.3GHz to 2.3GHz High Linearity Upconverting Mixer	15.9dBm IIP3 at 1.9GHz, Integrated RF Output Transformer with 50Ω Matching, Single-Ended LO and RF Ports Operation
LT5521	10MHz to 3700MHz High Linearity Upconverting Mixer	24.2dBm IIP3 at 1.95GHz, NF = 12.5dB, 3.15V to 5.25V Supply, Single-Ended LO Port Operation
LT5522	600MHz to 2.7GHz High Signal Level Downconverting Mixer	4.5V to 5.25V Supply, 25dBm IIP3 at 900MHz, NF = 12.5dB, 50Ω Single-Ended RF and LO Ports
LT5524	Low Power, Low Distortion ADC Driver with Digitally Programmable Gain	450MHz Bandwidth, 40dBm OIP3, 4.5dB to 27dB Gain Control
LT5525	High Linearity, Low Power Downconverting Mixer	Single-Ended 50Ω RF and LO Ports, 17.6dBm IIP3 at 1900MHz, I _{CC} = 28mA
LT5526	High Linearity, Low Power Downconverting Mixer	3V to 5.3V Supply, 16.5dBm IIP3, 100kHz to 2GHz RF, NF = 11dB, I _{CC} = 28mA, -65dBm LO-RF Leakage
LT5527	400MHz to 3.7GHz High Signal Level Downconverting Mixer	IIP3 = 23.5dBm and NF = 12.5dBm at 1900MHz, 4.5V to 5.25V Supply, I _{CC} = 78mA, Conversion Gain = 2dB
LT5528	1.5GHz to 2.4GHz High Linearity Direct Quadrature Modulator	21.8dBm OIP3 at 2GHz, -159.3dBm/Hz Noise Floor, 50Ω, 0.5V _{DC} Baseband Interface, 4-Channel W-CDMA ACPR = -66dBc at 2.14GHz
LT5558	600MHz to 1100MHz High Linearity Direct Quadrature Modulator	22.4dBm OIP3 at 900MHz, -158dBm/Hz Noise Floor, 3kΩ, 2.1V _{DC} Baseband Interface, 3-Ch CDMA2000 ACPR = -70.4dBc at 900MHz
LT5560	Ultra-Low Power Active Mixer	10mA Supply Current, 10dBm IIP3, 10dB NF, Usable as Up- or Down-Converter.
LT5568	700MHz to 1050MHz High Linearity Direct Quadrature Modulator	22.9dBm OIP3 at 850MHz, -160.3dBm/Hz Noise Floor, 50Ω, 0.5V _{DC} Baseband Interface, 3-Ch CDMA2000 ACPR = -71.4dBc at 850MHz
LT5572	1.5GHz to 2.5GHz High Linearity Direct Quadrature Modulator	21.6dBm OIP3 at 2GHz, -158.6dBm/Hz Noise Floor, High-Ohmic 0.5V _{DC} Baseband Interface, 4-Ch W-CDMA ACPR = -67.7dBc at 2.14GHz
RF Power Detectors		
LTC®5505	RF Power Detectors with >40dB Dynamic Range	300MHz to 3GHz, Temperature Compensated, 2.7V to 6V Supply
LTC5507	100kHz to 1000MHz RF Power Detector	100kHz to 1GHz, Temperature Compensated, 2.7V to 6V Supply
LTC5508	300MHz to 7GHz RF Power Detector	44dB Dynamic Range, Temperature Compensated, SC70 Package
LTC5509	300MHz to 3GHz RF Power Detector	36dB Dynamic Range, Low Power Consumption, SC70 Package
LTC5530	300MHz to 7GHz Precision RF Power Detector	Precision V _{OUT} Offset Control, Shutdown, Adjustable Gain
LTC5531	300MHz to 7GHz Precision RF Power Detector	Precision V _{OUT} Offset Control, Shutdown, Adjustable Offset
LTC5532	300MHz to 7GHz Precision RF Power Detector	Precision V _{OUT} Offset Control, Adjustable Gain and Offset
LT5534	50MHz to 3GHz Log RF Power Detector with 60dB Dynamic Range	±1dB Output Variation over Temperature, 38ns Response Time, Log Linear Response
LTC5536	Precision 600MHz to 7GHz RF Power Detector with Fast Comparator Output	25ns Response Time, Comparator Reference Input, Latch Enable Input, -26dBm to +12dBm Input Range
LT5537	Wide Dynamic Range Log RF/IF Detector	Low Frequency to 1GHz, 83dB Log Linear Dynamic Range

X-ON Electronics

Largest Supplier of Electrical and Electronic Components

Click to view similar products for [Modulator/Demodulator](#) category:

Click to view products by [Analog Devices](#) manufacturer:

Other Similar products are found below :

[LC72722PM-TLM-E](#) [HMC495LP3TR](#) [LT5571EUF#PBF](#) [LT5528EUF#PBF](#) [LT5502EGN#PBF](#) [THAT1510S08-U](#) [CMX589AD5](#)
[ADRF6821ACPZ](#) [AD630ADZ](#) [AD630ARZ](#) [AD630JNZ](#) [AD630KNZ](#) [AD8346ARUZ-REEL7](#) [AD8339ACPZ](#) [AD8345ARE](#) [AD8345AREZ](#)
[AD8345AREZ-RL7](#) [AD8347ARUZ](#) [AD8347ARUZ-REEL7](#) [AD8348ARUZ](#) [AD8348ARUZ-REEL7](#) [AD8349AREZ](#) [AD8349AREZ-RL7](#)
[ADL5371ACPZ-R7](#) [ADL5387ACPZ-WP](#) [ADL5387ACPZ-R7](#) [ADL5372ACPZ-R7](#) [ADL5373ACPZ-R7](#) [ADA2200ARUZ-REEL7](#)
[AD8346ARUZ](#) [ADL5380-EVALZ](#) [ADL5382ACPZ-R7](#) [AD630ARZ-RL](#) [ADL5375-15ACPZ-R7](#) [ADL5380ACPZ-R7](#) [ADL5375-05ACPZ-R7](#)
[AD8333ACPZ-WP](#) [AD8341ACPZ-REEL7](#) [ADRF6703ACPZ-R7](#) [ADRF6750ACPZ-R7](#) [ADRF6806ACPZ-R7](#) [HMC1097LP4E](#)
[HMC630LP3ETR](#) [HMC500LP3ETR](#) [HMC495LP3ETR](#) [HMC500LP3E](#) [HMC630LP3E](#) [HMC631LP3E](#) [HMC795LP5E](#) [MC1496DR2G](#)