

# 40V, 2.5A, Low I<sub>Q</sub> Synchronous Step-Up Silent Switcher with PassThru

## FEATURES

- **Silent Switcher® Architecture**
  - **Ultralow EMI Emissions**
  - **Optional Spread Spectrum Frequency Modulation**
- **Integrated 40V, 2.5A Power Switches**
- **Wide Input/Output Voltage Range: 2.7V to 40V**
- **Low V<sub>IN</sub> Pin Quiescent Current:**
  - **0.3µA in Shutdown**
  - **4µA in Burst Mode® Operation**
  - **15µA in PassThru™ Operation**
- **100% Duty Cycle Capability for Synchronous MOSFET**
- **Adjustable and Synchronizable: 300kHz to 3MHz**
- **Pulse-Skipping or Burst Mode Operation at Light Load**
- **Output Soft-Start and Power Good Monitor**
- **Internal Compensation**
- **Accurate 1V Enable Pin Threshold**
- **Small 16-Lead (3mm × 3mm) LQFN Package**
- **AEC-Q100 Qualified for Automotive Applications**

## APPLICATIONS

- Automotive and Industrial Power Supplies
- General Purpose Step-Up

## DESCRIPTION

The **LT®8336** is a low I<sub>Q</sub>, synchronous step-up DC/DC converter. It features Silent Switcher architecture and optional spread spectrum frequency modulation to minimize EMI emissions while delivering high efficiencies at high switching frequencies.

The wide input/output voltage range, low V<sub>IN</sub> pin quiescent current in Burst Mode operation, and 100% duty cycle capability for the synchronous MOSFET in PassThru operation (V<sub>IN</sub> ≥ V<sub>OUT</sub>), make the LT8336 ideally suited for general purpose step-up and automotive preboost applications.

The LT8336 integrates 40V, 2.5A power switches, operating at a fixed switching frequency programmable between 300kHz and 3MHz and synchronizable to an external clock. Pulse-skipping or Burst Mode operation can be selected, with or without spread-spectrum frequency modulation, to optimize efficiency and EMI performance.

The LT8336 features output soft-start, an output power good flag and output overvoltage lockout.

All registered trademarks and trademarks are the property of their respective owners. Protected by U.S patents, including 10686381.

## TYPICAL APPLICATION

**High Efficiency 8V to 16V Input, 2MHz, 24V Output Boost Converter**

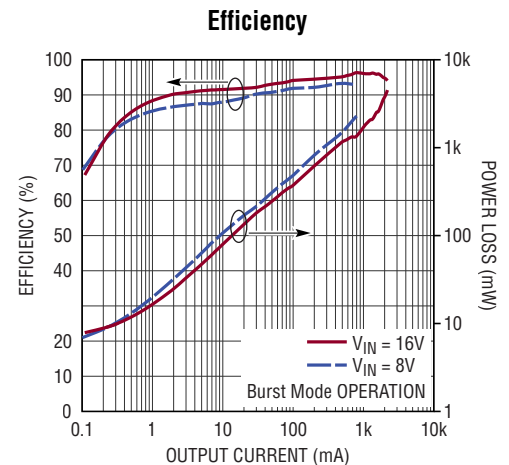
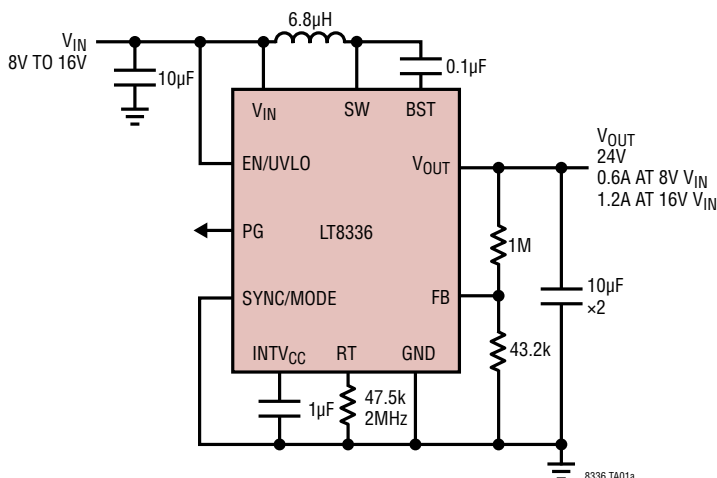

# LT8336

## ABSOLUTE MAXIMUM RATINGS

(Note 1)

$V_{IN}$ , $V_{OUT}$ , EN/UVLO .....	40V
SYNC/MODE, FB .....	6V
PG .....	10V
Operating Junction Temperature Range (Notes 2, 3)	
LT8336E .....	-40°C to 125°C
LT8336J .....	-40°C to 150°C
LT8336H .....	-40°C to 150°C
Storage Temperature Range .....	
Maximum Reflow (Package Body) Temperature .....	260°C

## PIN CONFIGURATION

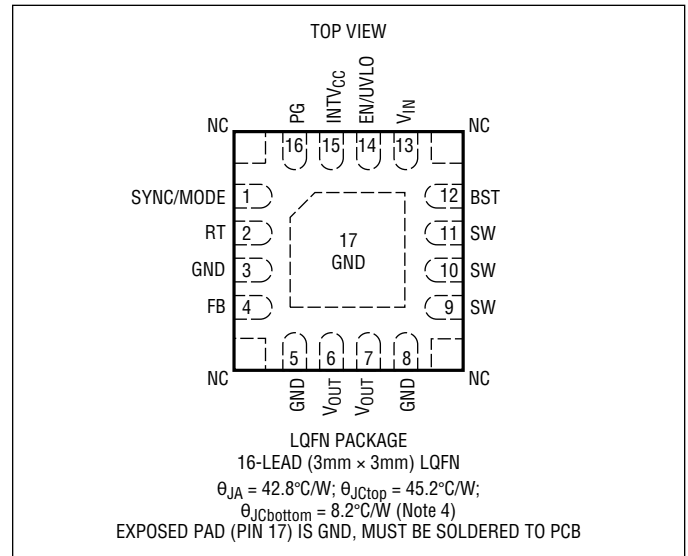

## ORDER INFORMATION

PART NUMBER	PART MARKING		PAD FINISH	PACKAGE* TYPE	MSL RATING	TEMPERATURE RANGE (SEE NOTE 2)
	DEVICE	FINISH CODE				
LT8336EV#PBF	LHHP	e4	Au (RoHS)	LQFN (Laminate Package with QFN Footprint)	3	-40°C to 125°C
LT8336JV#PBF						-40°C to 150°C
LT8336HV#PBF						-40°C to 150°C
<b>AUTOMOTIVE PRODUCTS**</b>						
LT8336EV#WPBF	LHHP	e4	Au (RoHS)	LQFN (Laminate Package with QFN Footprint)	3	-40°C to 125°C
LT8336JV#WPBF						-40°C to 150°C
LT8336HV#WPBF						-40°C to 150°C

• Contact the factory for parts specified with wider operating temperature ranges. Pad or ball finish code is per IPC/JEDEC J-STD-609.

\*The LT8336 package has the same dimensions as a standard 3mm x 3mm QFN.

\*\*Versions of this part are available with controlled manufacturing to support the quality and reliability requirements of automotive applications. These models are designated with a #W suffix. Only the automotive grade products shown are available for use in automotive applications. Contact your local Analog Devices account representative for specific product ordering information and to obtain the specific Automotive Reliability reports for these models.

• [Recommended LGA and BGA PCB Assembly and Manufacturing Procedures](#)

• [LGA and BGA Package and Tray Drawings](#)

## ELECTRICAL CHARACTERISTICS

The ● denotes the specifications which apply over the full operating temperature range, otherwise specifications are at  $T_A = 25^{\circ}\text{C}$ .  $V_{IN} = 5\text{V}$ , EN/UVLO = 2V, unless otherwise noted.

PARAMETER	CONDITIONS	MIN	TYP	MAX	UNITS
$V_{IN}$ Operation Voltage		● 2.7		40	V
$V_{IN}$ Quiescent Current	EN/UVLO = 0.15V		0.3	1	$\mu\text{A}$
	EN/UVLO = 0.15V	●	0.3	10	$\mu\text{A}$
	SYNC/MODE = 0V, Not Switching		4	8	$\mu\text{A}$
	SYNC/MODE = Open, Not Switching		0.9	1.5	mA
	$V_{IN} = 10.1\text{V}$ , $V_{OUT} = 10\text{V}$ , FB = 1.05V (In PassThru Mode)		15	25	$\mu\text{A}$

Rev. A

**ELECTRICAL CHARACTERISTICS** The ● denotes the specifications which apply over the full operating temperature range, otherwise specifications are at  $T_A = 25^\circ\text{C}$ .  $V_{IN} = 5\text{V}$ ,  $\text{EN}/\text{UVLO} = 2\text{V}$ , unless otherwise noted.

PARAMETER	CONDITIONS		MIN	TYP	MAX	UNITS
FB Regulation Voltage	E-Grade/H-Grade J-Grade	●	0.994	1.000	1.006	V
			0.985	1.000	1.010	V
		●	0.980	1.000	1.012	V
FB Line Regulation	$2.7\text{V} < V_{IN} < 40\text{V}$	●		0.005	0.02	%/V
FB Pin Input Current	$\text{FB} = 1.0\text{V}$		-20		20	nA
Switching Frequency	$R_T = 357\text{k}\Omega$ $R_T = 102\text{k}\Omega$ $R_T = 47.5\text{k}\Omega$ $R_T = 30.1\text{k}\Omega$			300		kHz
				1		MHz
		●	1.85	2	2.15	MHz
				3		MHz
Spread Spectrum Modulation Frequency as Percentage of $f_{\text{SW}}$				0.45		%
Spread Spectrum Modulation Frequency Range as Percentage of $f_{\text{SW}}$				20		%
Synchronizable Frequency	$\text{SYNC}/\text{MODE} = \text{External Clock}$	●	0.3		3	MHz
SYNC/MODE Pin Input Logic Level for Frequency Synchronization	SYNC Logic Low SYNC Logic High	●			0.4	V
		●	1.7			V
Soft-Start Time	$R_T = 47.5\text{k}\Omega$			1.4		ms
EN/UVLO Threshold Voltage	Falling Hysteresis	●	0.94	1.0	1.06	V
				100		mV
EN/UVLO Input Bias Current	$\text{EN}/\text{UVLO} = 2\text{V}$		-40		40	nA
PG Upper Threshold Offset from Regulated FB	FB Falling Hysteresis	●	5	8	12	%
				1		%
PG Lower Threshold Offset from Regulated FB	FB Rising Hysteresis	●	-12	-8	-5	%
				1		%
PG Leakage Current	$\text{PG} = 3.5\text{V}$		-40		40	nA
PG Pull-Down Resistance	$\text{PG} = 0.1\text{V}$	●		700	2000	$\Omega$
Bottom Switch On-Resistance	$I_{\text{SW}} = 1\text{A}$			70		m $\Omega$
Bottom Switch Current Limit		●	2.5	3	3.3	A
Bottom Switch Minimum Off-time			20		50	ns
Bottom Switch Minimum On-time	$V_{IN} = 9.5\text{V}$ , $V_{OUT} = 10\text{V}$		20		80	ns
Top Switch On-Resistance	$I_{\text{SW}} = 1\text{A}$			75		m $\Omega$
SW Leakage Current	$V_{OUT} = 40\text{V}$ , $\text{SW} = 0\text{V}$ , $40\text{V}$		-1.5		1.5	$\mu\text{A}$
$V_{OUT}$ Pin Current	SYNC/MODE = 0V, $V_{OUT} = 10\text{V}$ , Not Switching $V_{IN} = 10.1\text{V}$ , $V_{OUT} = 10\text{V}$ , $\text{FB} = 1.05\text{V}$ (In PassThru Mode)			1		$\mu\text{A}$
				30		$\mu\text{A}$
PassThru Mode $V_{IN}$ to $V_{OUT}$ Threshold ( $V_{IN} - V_{OUT}$ )	FB = 1.05V, $V_{IN}$ Rising FB = 1.05V, $V_{IN}$ Falling			0		V
				-0.6		V
PassThru Mode Top Switch Reverse Current Limit	$V_{IN} = 9.9\text{V}$ , $V_{OUT} = 10\text{V}$ , $\text{FB} = 1.05\text{V}$ (Top Switch Turns Off)			750		mA

**Note 1:** Stresses beyond those listed under Absolute Maximum Ratings may cause permanent damage to the device. Exposure to any Absolute Maximum Rating condition for extended periods may affect device reliability and lifetime.

**Note 2:** The LT8336E is guaranteed to meet performance specifications from the  $0^\circ\text{C}$  to  $125^\circ\text{C}$  junction temperature. Specifications over the  $-40^\circ\text{C}$  to  $125^\circ\text{C}$  operating junction temperature range are assured by design, characterization and correlation with statistical process controls. The LT8336J/ LT8336H are guaranteed to meet performance specifications over the  $-40^\circ\text{C}$  to  $150^\circ\text{C}$  operating junction temperature ranges. High

junction temperatures degrade operating lifetimes; operating lifetime is de-rated for junction temperatures greater than  $125^\circ\text{C}$ .

**Note 3:** These ICs include overtemperature protection that is intended to protect the device during momentary overload conditions. The maximum rated junction temperature will be exceeded when this protection is active. Continuous operation above the specified absolute maximum operating junction temperature may impair device reliability or permanently damage the device.

**Note 4:**  $\theta$  values are determined by simulation per JESD51 conditions.

**TYPICAL PERFORMANCE CHARACTERISTICS**  $T_A \approx T_J = 25^\circ\text{C}$ , unless otherwise noted.

**Efficiency and Power Loss vs Output Current**

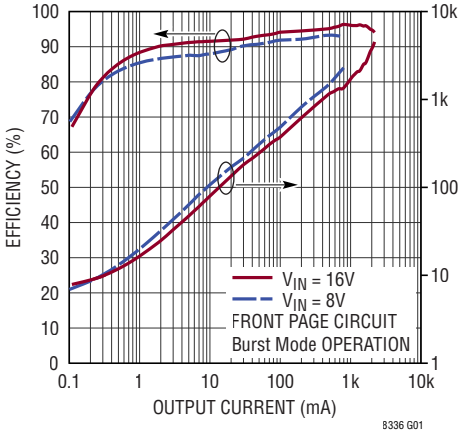

**Efficiency and Power Loss vs Output Current**

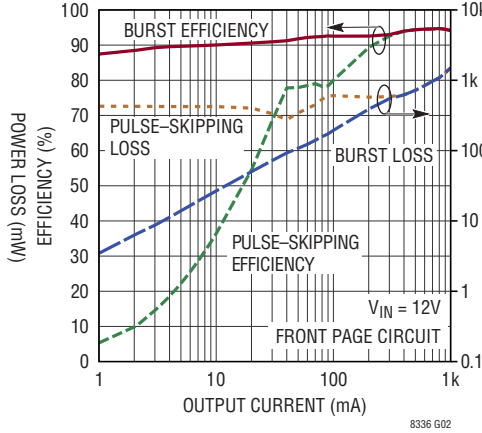

**Burst Mode Efficiency vs Inductor Value**

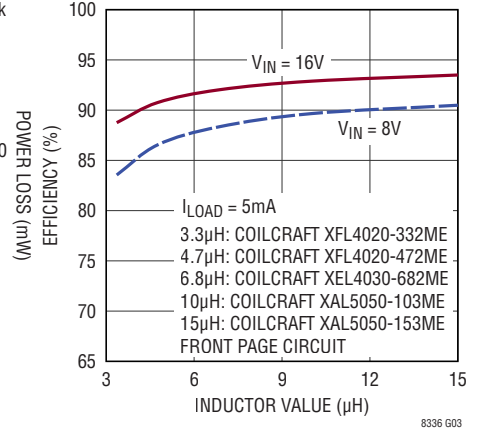

**Efficiency vs Output Current at Different Switching Frequencies**

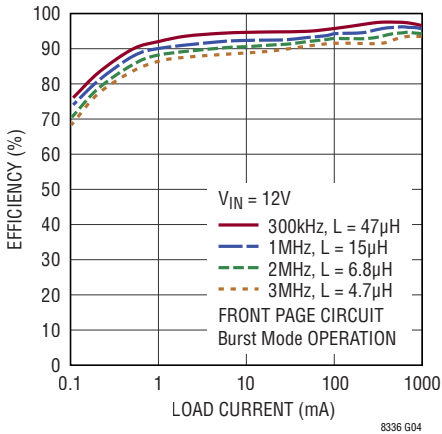

**EN/UVLO Thresholds vs Temperature**

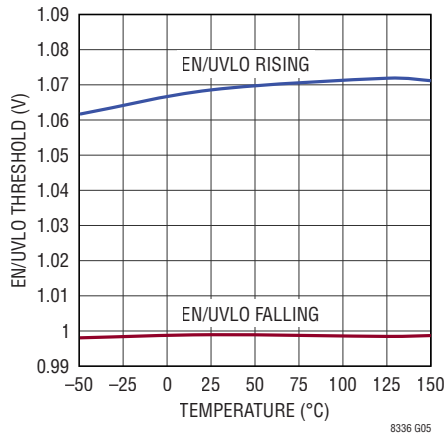

**FB Regulation Voltage vs Temperature**

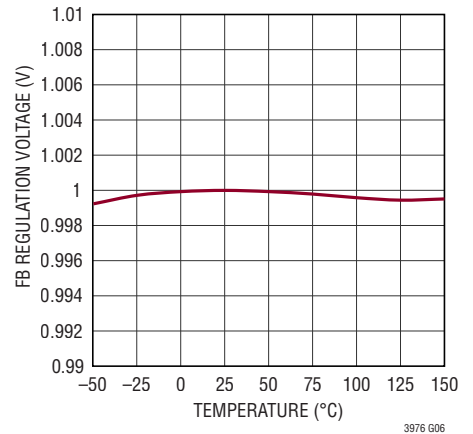

**Oscillator Frequency vs Temperature**

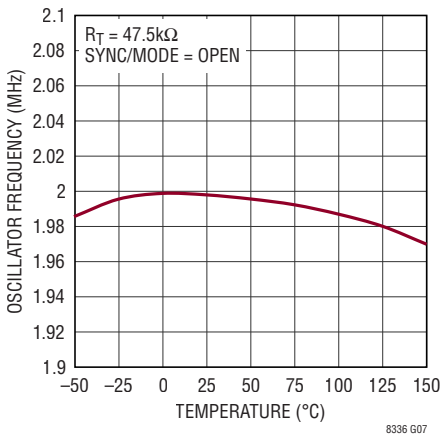

**Oscillator Frequency with Spread Spectrum Modulation**

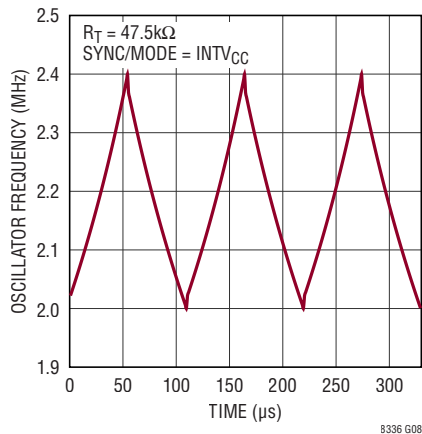

**Switching Waveforms, Soft-Start**

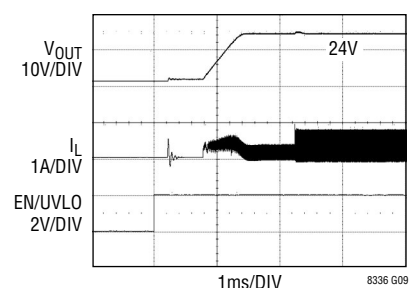

$V_{IN} = 12\text{V}$   
FRONT PAGE CIRCUIT

**TYPICAL PERFORMANCE CHARACTERISTICS**  $T_A \approx T_J = 25^\circ\text{C}$ , unless otherwise noted.

**Switching Waveforms, Soft-Start at Different  $V_{IN}$  Voltages**

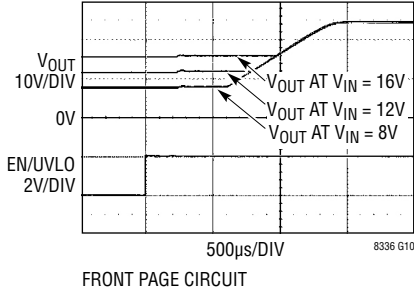

**Bottom Switch Current Limit vs Temperature**

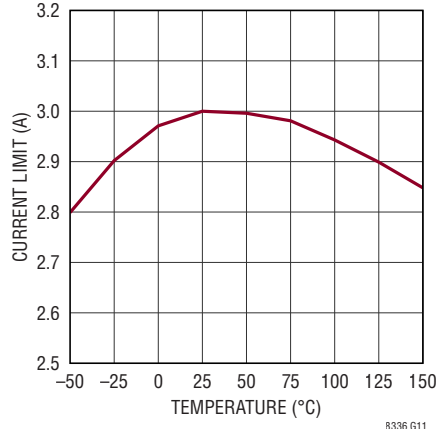

**Max Programmable Switching Frequency vs Input Voltage**

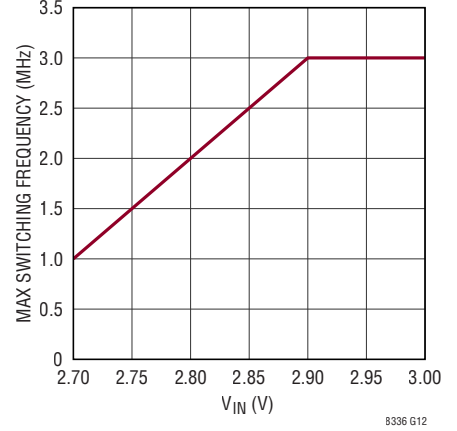

**Switching Waveforms, Current Limit at 15% Duty Cycle**

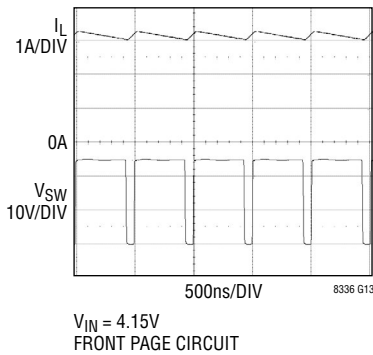

**Switching Waveforms, Current Limit at 85% Duty Cycle**

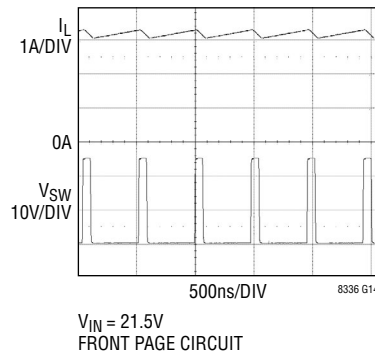

**Power Switch Voltage Drop vs Switch Current**

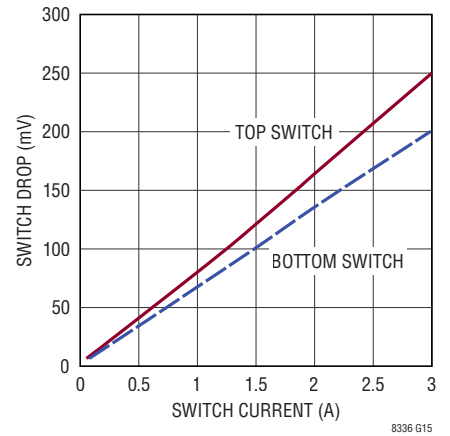

**Power Switch Voltage Drop vs Temperature**

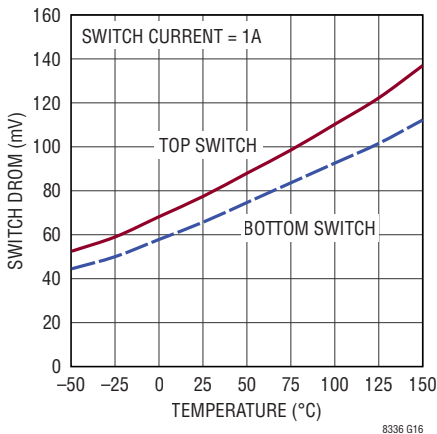

**Switching Waveforms, Load Step in Pulse-Skipping Mode Operation**

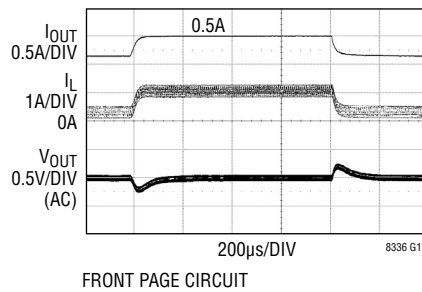

**Switching Waveforms, Load Step in Burst Mode Operation**

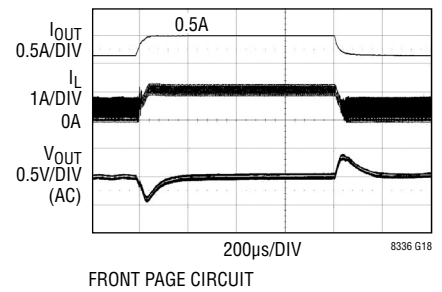

## TYPICAL PERFORMANCE CHARACTERISTICS $T_A \approx T_J = 25^\circ\text{C}$ , unless otherwise noted.

**Minimum On/Off Times vs Temperature**

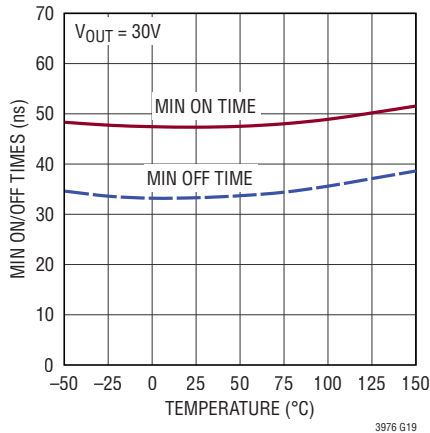

**Switching Waveforms, Full Frequency PWM Operation**

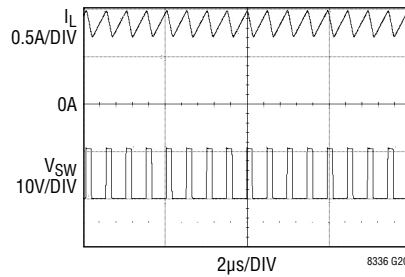

$V_{\text{IN}} = 3\text{V}$   
 $I_{\text{LOAD}} = 220\text{mA}$   
 $\text{SYNC/MODE} = 0\text{V}$   
 BACK PAGE CIRCUIT

**Switching Waveforms, Continuous Burst Mode Operation**

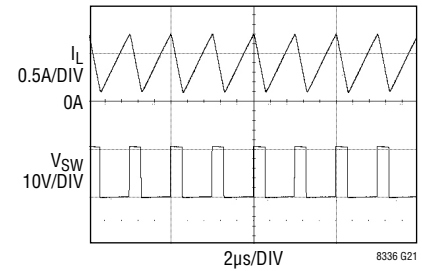

$V_{\text{IN}} = 3\text{V}$   
 $I_{\text{LOAD}} = 110\text{mA}$   
 $\text{SYNC/MODE} = 0\text{V}$   
 BACK PAGE CIRCUIT

**Switching Waveforms, Discontinuous Burst Mode Operation**

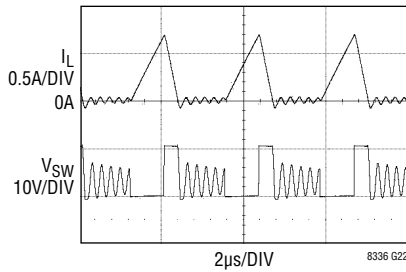

$V_{\text{IN}} = 3\text{V}$   
 $I_{\text{LOAD}} = 50\text{mA}$   
 $\text{SYNC/MODE} = 0\text{V}$   
 BACK PAGE CIRCUIT

**Switching Waveforms, Light Load Low IQ Burst Mode Operation**

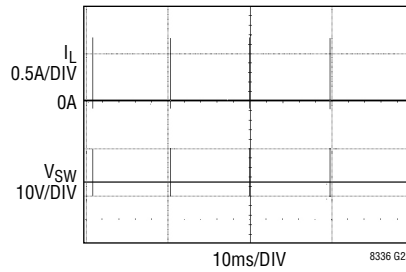

$V_{\text{IN}} = 3\text{V}$   
 $I_{\text{LOAD}} = 0\text{mA}$   
 $\text{SYNC/MODE} = 0\text{V}$   
 BACK PAGE CIRCUIT

**Switching Waveforms, Discontinuous Pulse-Skipping Mode**

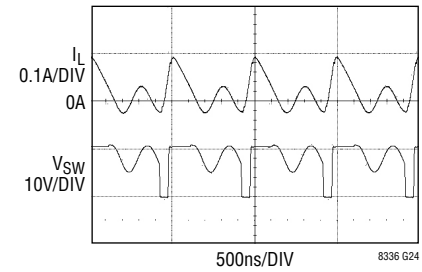

$V_{\text{IN}} = 3\text{V}$   
 $I_{\text{LOAD}} = 10\text{mA}$   
 $\text{SYNC/MODE} = \text{OPEN}$   
 BACK PAGE CIRCUIT

**Waveforms, PassThru Mode Operation**

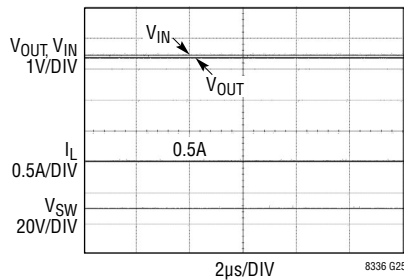

$I_{\text{LOAD}} = 0.5\text{A}$   
 $V_{\text{IN}} = 10.45\text{V}$   
 $\text{SYNC/MODE} = 0\text{V}$   
 BACK PAGE CIRCUIT

**Waveforms, Reverse Current Protection in PassThru Mode**

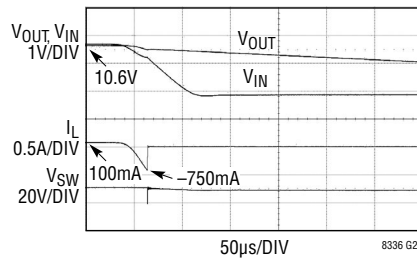

$\text{SYNC/MODE} = 0\text{V}$   
 BACK PAGE CIRCUIT

**Switching Waveforms, Frequency Foldback when  $V_{\text{IN}}$  is close to  $V_{\text{OUT}}$**

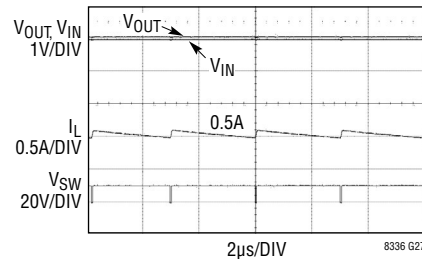

$I_{\text{LOAD}} = 0.5\text{A}$   
 $V_{\text{OUT}} = 10\text{V}$   
 $\text{SYNC/MODE} = 0\text{V}$   
 BACK PAGE CIRCUIT

**TYPICAL PERFORMANCE CHARACTERISTICS**  $T_A \approx T_J = 25^\circ\text{C}$ , unless otherwise noted.

**Conducted EMI Performance  
(CISPR25 Class 5 Peak)**

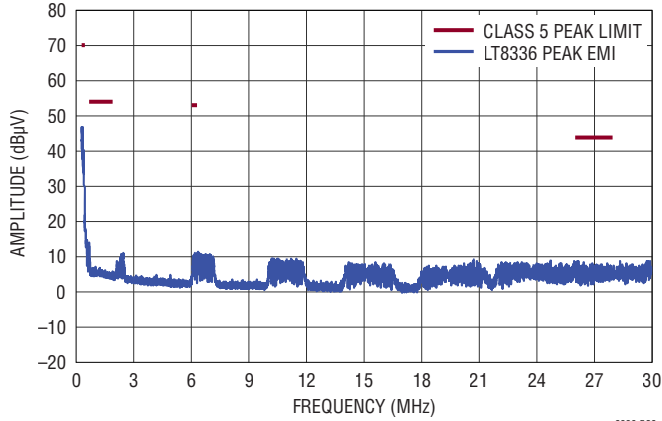

PAGE 18 CIRCUIT, 12V INPUT TO 24V OUTPUT AT 600mA,  
SSFM = ON,  $f_{\text{SW}} = 2\text{MHz TO } 2.4\text{MHz}$

8336 G28

**Conducted EMI Performance  
(CISPR25 Class 5 Average)**

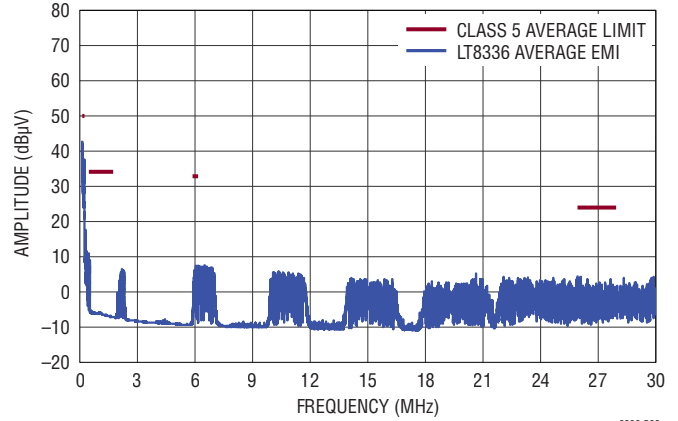

PAGE 18 CIRCUIT, 12V INPUT TO 24V OUTPUT AT 600mA,  
SSFM = ON,  $f_{\text{SW}} = 2\text{MHz TO } 2.4\text{MHz}$

8336 G29

**Radiated EMI Performance  
(CISPR25 Class 5 Peak)**

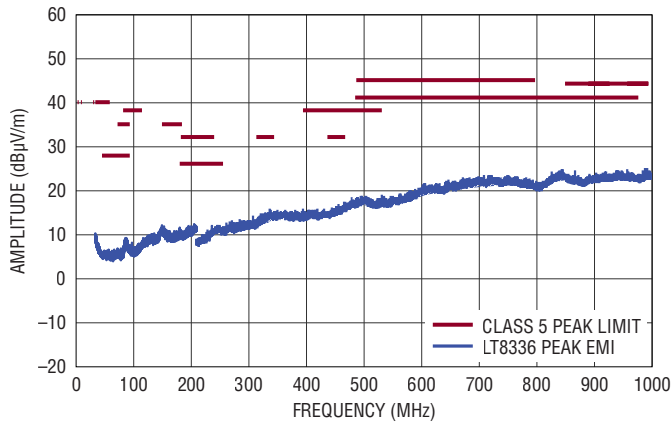

PAGE 18 CIRCUIT, 12V INPUT TO 24V OUTPUT AT 600mA,  
SSFM = ON,  $f_{\text{SW}} = 2\text{MHz TO } 2.4\text{MHz}$

8336 G30

**Radiated EMI Performance  
(CISPR25 Class 5 Average)**

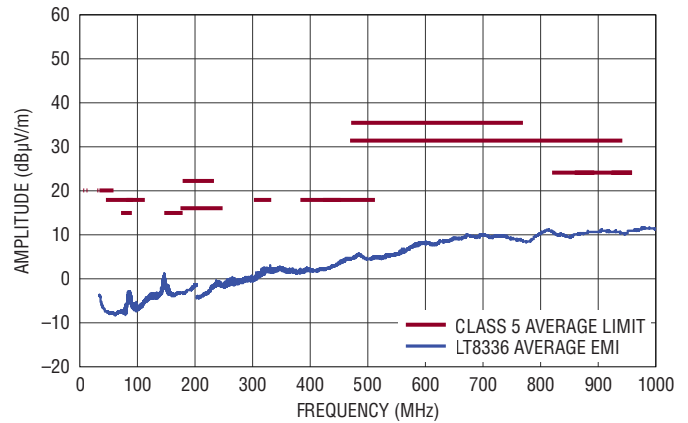

PAGE 18 CIRCUIT, 12V INPUT TO 24V OUTPUT AT 600mA,  
SSFM = ON,  $f_{\text{SW}} = 2\text{MHz TO } 2.4\text{MHz}$

8336 G31

## PIN FUNCTIONS

**SYNC/MODE (Pin 1):** External Synchronization Input and Mode Selection Pin. This pin allows five selectable modes for optimization of performance:

SYNC/MODE PIN INPUT	CAPABLE MODE(S) OF OPERATION
(1) GND or <0.1V	Burst
(2) 50k Resistor to GND	Burst/SSFM
(3) Float (Pin Open)	Pulse-Skipping
(4) $INTV_{CC}$ or $> (INTV_{CC} - 0.2V)$	Pulse-Skipping/SSFM
(5) External Clock	Pulse-Skipping/Sync

where the selectable modes of operation are:

Burst = low  $I_Q$ , (low output ripple operation at light loads)  
 Pulse-Skipping = skipped pulse(s) at light load (aligned clock)  
 SSFM = spread spectrum frequency modulation for low EMI  
 Sync = switching frequency synchronized to external clock

The LT8336 automatically selects pulse-skipping mode with no spread-spectrum frequency modulation during start-up, and The SYNC/MODE pin input configurations (1) through (4) are ignored.

The LT8336 automatically select low  $I_Q$  operation in the PassThru mode operation, and all the SYNC/MODE pin input configurations are ignored.

**RT (Pin 2):** Switching Frequency Adjustment Pin. The LT8336 switching frequency is programmed by connecting a resistor of the appropriate value from the RT pin to GND at Pin 3. See the Applications Information section for more detail. Do not leave the RT pin open.

**GND (Pins 3, 5, 8, Exposed Pad Pin 17):** Ground. The exposed pad should be soldered to the PCB ground plane for good thermal and electrical performance. See the Applications Information section for sample layout.

**FB (Pin 4):** Feedback Input Pin. This pin receives the feedback voltage from the external resistor divider between  $V_{OUT}$  and Pin 3 GND. FB pin is one input to the error amplifier of the output voltage control loop. See the Applications Information section for sample layout.

**$V_{OUT}$  (Pins 6, 7):** Output Pins. Connect one  $1\mu F$  capacitor between  $V_{OUT}$  at Pin 6 and GND at Pin 5 only, and a matching  $1\mu F$  capacitor between  $V_{OUT}$  at Pin 7 and GND

at Pin 8 only. These two capacitors complete the Silent Switcher configuration and must be placed as close to the IC as possible to achieve lowest EMI. Additional bulk capacitors of  $2.2\mu F$  or more should be placed close to the IC with the positive terminals connected to  $V_{OUT}$ , and negative terminals connected to ground plane. See the Applications Information section for a sample layout.

**SW (Pins 9, 10, 11):** The SW pins are the outputs of the internal power switches. Tie these pins together and connect them to the inductor and one side of the boost capacitor  $C_{BST}$ .

**BST (Pin 12):** Top Switch Gate Driver Supply Pin. Place a  $0.1\mu F$  capacitor ( $C_{BST}$ ) between the BST and SW pins and close to the IC.

**$V_{IN}$  (Pin 13):** Input Supply Pin. This pin must be connected to the input of the power stage (the inductor's input terminal).

**EN/UVLO (Pin 14):** Enable and Input Undervoltage Lockout Pin. The IC is shut down when this pin is below 1V (typical). The IC draws a low  $V_{IN}$  current of  $0.3\mu A$  (typical) when this pin is below 0.15V. The IC is enabled when this pin is above 1.0V (typical). A resistor divider from  $V_{IN}$  to GND can be used to program a  $V_{IN}$  threshold below which the IC is shut down. See the Applications Information section for further details. Tie EN/UVLO to  $V_{IN}$  if the shutdown feature is not used.

**$INTV_{CC}$  (Pin 15):** Internal 3.5V Regulator Bypass Pin. This pin provides supply for internal drivers and control circuits. The bypass capacitor for  $INTV_{CC}$  should be connected to the ground plane. Do not load the  $INTV_{CC}$  pin with external circuitry. This pin must be bypassed with a  $1\mu F$  or larger low ESR ceramic capacitor placed close to the pin.

**PG (Pins 16):** Power Good Indicator. Open-drain logic output that is pulled to ground when the output voltage is greater than  $\pm 8\%$  outside the regulated voltage. PG is also pulled to ground when EN/UVLO is below 1V,  $INTV_{CC}$  has fallen too low, or the IC enters thermal shutdown.



**BLOCK DIAGRAM**

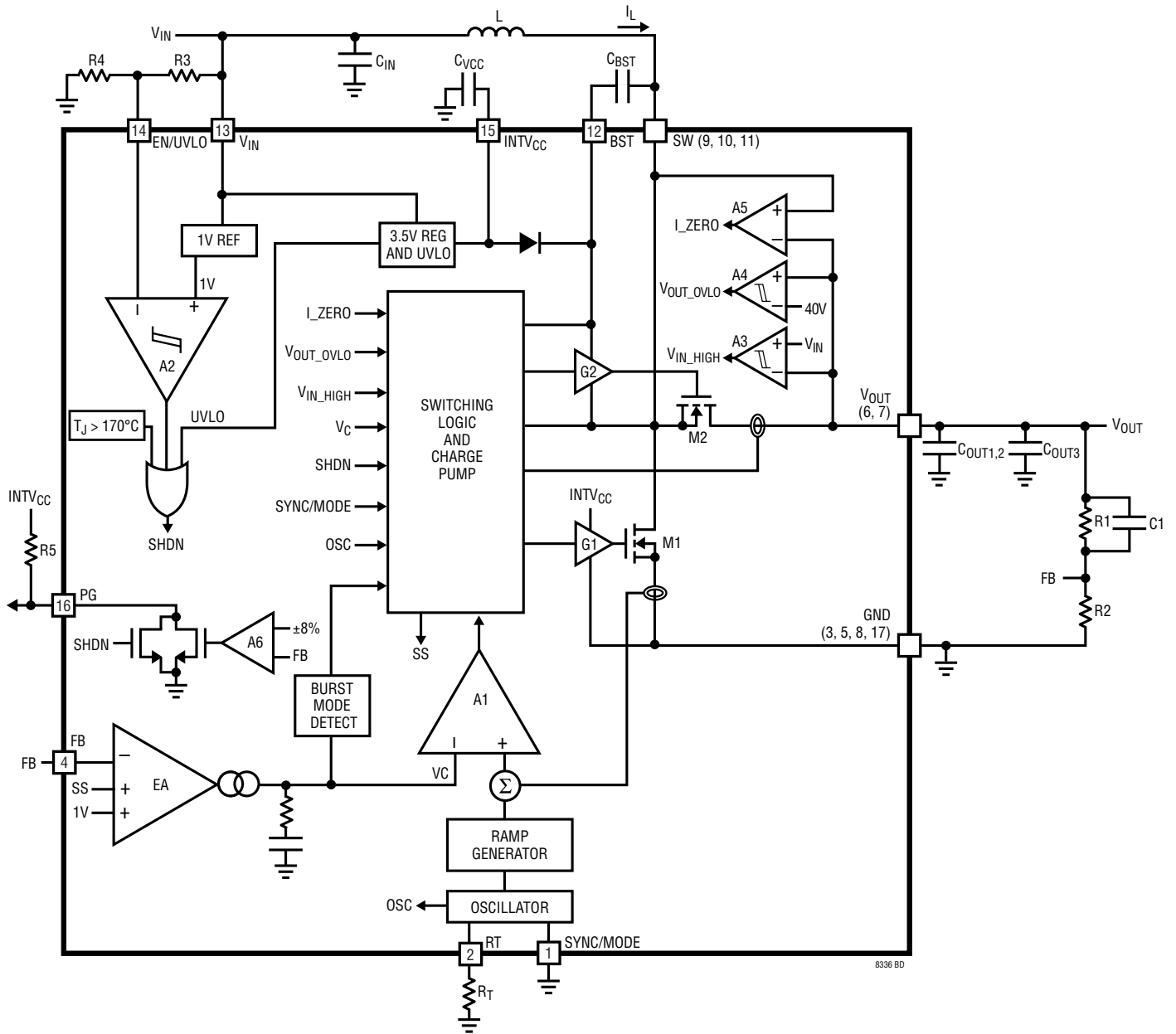

## OPERATION

The LT8336 uses a fixed frequency, current mode control scheme to provide excellent line and load regulation. Referring to the Block Diagram, the Switching Logic and Charge Pump block turns on the power switch M1 through driver G1 at the start of each oscillator cycle. During the M1 switch on-phase, the inductor current  $I_L$  flows through M1. A current proportional to the M1 switch current is added to a stabilizing slope compensation ramp and the resulting sum is fed into the positive terminal of the PWM comparator A1. The voltage at the negative input of A1, labeled “VC”, is set by the error amplifier EA and is an amplified version of the difference between the feedback voltage FB and the reference voltage. During the M1 on-phase,  $I_L$  increases. When the signal at the positive input of A1 exceeds VC, A1 sends out a signal to the Switching Logic and Charge Pump block to turn off M1. When M1 turns off, the synchronous power switch M2 turns on until the next clock cycle begins or inductor current  $I_L$  falls to zero. During the M1 off-phase,  $I_L$  decreases. Through this repetitive action, the EA sets the correct  $I_L$  peak current level to keep the output in regulation.  $V_{IN}$  and  $V_{OUT}$  are constantly monitored by the LT8336. When  $V_{IN}$  rises above  $V_{OUT}$  (causing A3’s output high) and at the same time  $V_{OUT}$  is higher than its regulation voltage programmed by the FB resistor network, the LT8336 enters PassThru operation, where M2 is kept on continuously and M1 is kept off continuously, and the  $V_{OUT}$  is essentially shorted to  $V_{IN}$  by the inductor and M2. See Applications Information section for further details.

LT8336 features Silent Switcher architecture to minimize EMI emissions while delivering high efficiency. The Silent Switcher EMI cancellation loops are completed by placing

one  $1\mu\text{F}$  capacitor between  $V_{OUT}$  at pin 6 and GND at pin 5 and a matching  $1\mu\text{F}$  capacitor between  $V_{OUT}$  at pin 7 and GND at pin 8 (see Applications Information section for further details).

The EN/UVLO pin controls whether the LT8336 is enabled or is in shutdown state. A 1.0V reference and a comparator A2 with 100mV hysteresis (Block Diagram) allow the user to accurately program the supply voltage at which the IC turns on and off. See the Applications Information section for further details.

The LT8336 features a variety of operation modes which can be selected by SYNC/MODE pin to optimize the converter performance based on the application requirements. The low ripple Burst Mode operation can be selected to optimize the efficiency at light loads. The spread spectrum frequency modulation function can be selected to minimize the EMI emissions.

Pulling SYNC/MODE pin to ground selects Burst Mode operation. Connecting this SYNC/MODE to ground through a 50k resistor selects Burst Mode operation with spread spectrum frequency modulation. Floating SYNC/MODE pin selects pulse-skipping operation. Connecting SYNC/MODE pin to INTV<sub>CC</sub> selects pulse-skipping operation with spread spectrum frequency modulation. If a clock is applied to the SYNC/MODE pin, the LT8336 synchronizes to an external clock frequency and operates in pulse-skipping mode. See the Applications Information section for further details.

## APPLICATIONS INFORMATION

### Programming $V_{IN}$ Turn-On and Turn-Off Thresholds with the EN/UVLO Pin

The falling threshold voltage and rising hysteresis voltage of the  $V_{IN}$  pin can be calculated by Equation 1.

$$V_{VIN,FALLING} = 1.0V \cdot \frac{(R3 + R4)}{R4} \quad (1)$$

$$V_{VIN,RISING} = 100mV \cdot \frac{(R3 + R4)}{R4} + V_{VIN,FALLING}$$

When in Burst Mode operation with light load currents, the current through the resistor network R3 and R4 can easily be greater than the supply current consumed by the LT8336. Therefore, large resistors can be used for R3 and R4 to minimize their effect on efficiency at light loads.

EN/UVLO pin can be tied to  $V_{IN}$  if the shutdown feature is not used, or alternatively, the pin may be tied to a logic level if shutdown control is required. The IC draws a low  $V_{IN}$  quiescent current of 0.3 $\mu$ A (typical) when EN/UVLO is below 0.15V.

### INTV<sub>CC</sub> Regulator

An internal low dropout (LDO) regulator produces the 3.5V supply from  $V_{IN}$  that powers the drivers and the internal bias circuitry. The INTV<sub>CC</sub> pin must be bypassed to ground with a minimum of 1 $\mu$ F ceramic capacitor. Good bypassing is necessary to supply the high transient currents required by the power MOSFET gate drivers. Applications with high  $V_{IN}$  voltage and high switching frequency increase die temperature because of the higher power dissipation across the LDO. When  $V_{IN}$  is lower than 2.9V, the maximum programmable switching frequency is lower due to the voltage drop across the LDO. See the Max Programmable Switching Frequency vs Input Voltage curve in the Typical Performance Characteristics section for more information. Do not connect an external load to the INTV<sub>CC</sub> pin.

### Light Load Current Operation—Burst Mode Operation or Pulse-Skipping

To enhance the efficiency at light loads, the LT8336 features operate in low ripple Burst Mode operation. When the LT8336 is enabled for Burst Mode operation, the minimum peak inductor current is set to approximately 700mA even though the VC node (Block Diagram) indicates a lower

value. In this condition, the LT8336 maintains the output regulation voltage by reducing the switching frequency instead of reducing the inductor peak current. In light load Burst Mode operation the LT8336 delivers single pulses of current to the output capacitor followed by sleep periods during which the output power is supplied by the output capacitor. This low ripple Burst Mode operation minimizes the input quiescent current and minimizes output voltage ripple. While in sleep mode the LT8336  $V_{IN}$  pin draws 4 $\mu$ A.

As the output load decreases, the frequency of single current pulses decreases and the percentage of time the LT8336 is in sleep mode increases, resulting in much higher light load efficiency than for typical converters. By maximizing the time between pulses, the converter  $V_{IN}$  pin quiescent current approaches 4 $\mu$ A for a typical application when there is no output load. To optimize the quiescent current performance at light loads, the current in the feedback resistor divider should be minimized as it appears to the output as load current.

In order to achieve higher light load efficiency, more energy should be delivered to the output during the single small pulses in Burst Mode operation such that the LT8336 can stay in sleep mode longer between each pulse. This can be achieved by using a larger value inductor. For example, while a smaller inductor value would typically be used for a high switching frequency application, if high light load efficiency is desired, a larger inductor value should be chosen. See the Burst Mode Efficiency vs Inductor Value curve in the Typical Performance Characteristics section for more information.

While in Burst Mode operation the bottom switch peak current is approximately 700mA as shown in the Switching Waveforms in Burst Mode operation curve in the Typical Performance Characteristics section. This behavior results in larger output voltage ripple compared to that in pulse-skipping mode operation which has lower bottom switch peak current. However, the output voltage ripple can be reduced proportionally by increasing the output capacitance. When adjusting output capacitance, a careful evaluation of system stability should be made to ensure adequate design margin. As the load ramps upward from zero, the switching frequency keeps increasing until reaching the switching frequency programmed by the resistor at the RT pin. The output load at which the

## APPLICATIONS INFORMATION

LT8336 reaches the programmed frequency varies based on input voltage, output voltage, and inductor choice.

Pulse-skipping mode operation offers two major differences from Burst Mode operation. First, the internal clock stays awake at all times and all switching cycles are aligned to the clock. In this mode the internal circuitry is awake at all times, increasing quiescent current to hundred  $\mu\text{A}$  compared to the  $4\mu\text{A}$  of  $V_{\text{IN}}$  pin quiescent current in Burst Mode operation. Second, as the load ramps upward from zero, the switching frequency programmed by the resistor at the  $R_{\text{T}}$  pin is reached at a lower output load than in Burst Mode operation, therefore, pulse-skipping mode operation exhibits lower output ripple as well as lower audio noise and RF interference.

### Switching Frequency and Synchronization

The choice of switching frequency is a trade-off between efficiency and component size. Low frequency operation improves efficiency by reducing the power switches' switching losses and gate drive current. However, lower frequency operation requires a physically larger inductor. The LT8336 uses a constant-frequency architecture that can be programmed over a 300kHz to 3MHz range with a single external resistor from the  $R_{\text{T}}$  pin to ground, as shown in Block Diagram. A table for selecting the value of  $R_{\text{T}}$  for a given switching frequency is shown in Table 1. Figure 1 shows the  $R_{\text{T}}$  Value vs Switching Frequency curve.

**Table 1. SW Frequency ( $f_{\text{SW}}$ ) vs  $R_{\text{T}}$  Value**

$f_{\text{SW}}$ (MHz)	$R_{\text{T}}$ (k $\Omega$ )	$f_{\text{SW}}$ (MHz)	$R_{\text{T}}$ (k $\Omega$ )
0.3	357	1.7	57.6
0.4	267	1.8	53.6
0.5	210	1.9	51.1
0.6	174	2.0*	47.5
0.7	147	2.1	45.2
0.8	127	2.2	43.2
0.9	113	2.3	40.2
1.0	102	2.4	39.2
1.1	90.9	2.5	37.4
1.2	84.5	2.6	35.7
1.3	76.8	2.7	34.0
1.4	71.5	2.8	32.4
1.5	64.9	2.9	30.9
1.6	61.9	3.0	30.1

\*Programming 2MHz will ensure  $f_{\text{SW}}$  stays above 1.85MHz (out of AM band).

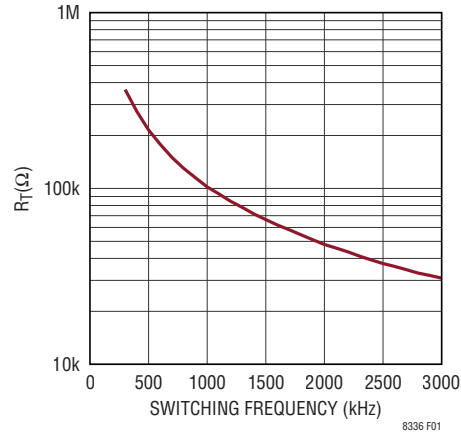

**Figure 1.  $R_{\text{T}}$  Value vs Switching Frequency**

The operating frequency of the LT8336 can be synchronized to an external clock source with 100ns minimum pulse width. By providing a digital clock signal to the SYNC/MODE pin, the LT8336 operates at the SYNC pulse frequency and automatically enters pulse-skipping mode operation at light load. If this feature is used, an  $R_{\text{T}}$  resistor should be chosen to program a switching frequency as close as possible to the SYNC pulse frequency.

### Spread Spectrum Frequency Modulation

The LT8336 features spread spectrum frequency modulation to further reduce EMI emissions. The user can select spread spectrum frequency modulation with Burst Mode operation by connecting the SYNC/MODE pin to ground through a 50k resistor, or spread spectrum frequency modulation with pulse-skipping operation by connecting the SYNC/MODE pin to  $\text{INTV}_{\text{CC}}$ . When spectrum frequency modulation is selected, a stepped triangular frequency modulation is used to vary the internal oscillator frequency between the value programmed by the  $R_{\text{T}}$  resistor to approximately 20% higher than that value. The modulation frequency is approximately 0.45% of the switching frequency. For example, when the LT8336 is programmed to 2MHz, and spread spectrum frequency modulation is selected, the oscillator frequency varies from 2MHz to 2.4MHz at a 9kHz rate (see Oscillator Frequency with Spread Spectrum Modulation curve in the Typical Performance Characteristics section). When operating at light load, the spread spectrum frequency modulation is more effective in pulse-skipping mode than

## APPLICATIONS INFORMATION

in Burst Mode operation, due to the fact that pulse-skipping operation maintains the programmed switching frequency down to a much lower load current as compared to Burst Mode operation.

### $V_{IN}$ to $V_{OUT}$ PassThru Mode Operation

In the boost pre-regulator applications for automotive stop-start and cold crank,  $V_{IN}$  is normally above the regulated  $V_{OUT}$  voltage. In this condition, LT8336 enters PassThru operation. LT8336 is designed to have an accurate, well controlled PassThru operation with low quiescent current consumption. If  $V_{IN}$  transiently falls below the  $V_{OUT}$  regulation setpoint, the boost converter commences switching to maintain the output voltage in regulation.

As shown in Block Diagram,  $V_{IN}$  is compared with  $V_{OUT}$  using the comparator A3 with 0.6V hysteresis. When  $V_{IN}$  rises above  $V_{OUT}$  (causing A3's output high), and at the same time  $V_{OUT}$  is higher than its regulation voltage programmed by the FB resistor network, the LT8336 boost converter enters PassThru operation, where the synchronous power switch M2 is kept on continuously and the power switch M1 is kept off continuously. The voltage across the boost capacitor ( $C_{BST}$ ),  $V_{BST\_SW}$ , is constantly monitored. When  $V_{BST\_SW}$  drops below 3.2V, an internal charge pump is turned on to charge  $V_{BST\_SW}$  up to 3.6V, and then turned off. In PassThru mode the  $V_{OUT}$  is essentially shorted to  $V_{IN}$  by the inductor and M2, and  $V_{IN}$  pin quiescent current is limited to 15 $\mu$ A (typ) regardless of the SYNC/MODE pin's configuration.  $V_{OUT}$  pin draws 30 $\mu$ A (typ). A typical waveforms drawing is shown in the Typical Performance Characteristics section.

Several conditions cause the LT8336 to exit from the PassThru mode operation. First, when  $V_{OUT}$  drops below its regulation voltage programmed by the FB resistor network, LT8336 exits from PassThru mode operation and normal boost switching operation resumes to maintain the regulated  $V_{OUT}$  voltage. Second, when  $V_{OUT}$  is still higher than its regulation voltage but  $V_{IN}$  drops below  $V_{OUT}$  by the comparator A3's hysteresis of 0.6V (typ) or more to cause A3's output low, M2 is turned off to prevent the reverse current from  $V_{OUT}$  to  $V_{IN}$  from ramping up. LT8336 is back to the PassThru mode when A3's output

is high again. Third, when  $V_{OUT}$  is still higher than its regulation voltage but M2's reverse current (flowing from its drain to source) rises above 750mA (typ), M2 is turned off to prevent the reverse current from  $V_{OUT}$  to  $V_{IN}$  from ramping up. LT8336 re-enters the PassThru mode when A3's output is high again. Waveforms for typical reverse current protection are shown in the Typical Performance Characteristics section.

To ensure the PassThru mode operation works properly, the LT8336's  $V_{IN}$  pin must be connect to the input of the power stage (the input terminal of inductor as shown in Block Diagram).

### FB Resistor Network and the Quiescent Current at No-Load

The output voltage is programmed with a resistor divider between the output and the FB pin. Choose the resistor values according to Equation 2.

$$R1 = R2 \cdot \left( \frac{V_{OUT}}{1V} - 1 \right) \quad (2)$$

Reference designators refer to Block Diagram. The 1% resistors are recommended to maintain output voltage accuracy.

If low input quiescent current and good light-load efficiency are desired, use large resistor values for the FB resistor divider. The current flowing in the divider acts as a load current, and will increase the no-load input current to the converter.

When  $V_{IN} < V_{OUT}$ , the converter Burst Mode quiescent current at no-load can be estimated using Equation 3.

$$I_Q \approx 4\mu A + \left( \frac{V_{OUT}}{R1 + R2} + 1\mu A \right) \cdot \left( \frac{V_{OUT}}{V_{IN}} \right) \cdot 1.25 \quad (3)$$

where 4 $\mu$ A is the  $V_{IN}$  pin quiescent current of the LT8336, and the second term is the current drawn by the feedback divider and  $V_{OUT}$  pin (1 $\mu$ A) reflected to the input of the boost operating.

For a 12V input, 24V output boost converter with  $R1 = 1M$  and  $R2 = 43.2k$ , it can be calculated that the converter draws approximately 64 $\mu$ A from the 12V supply at

## APPLICATIONS INFORMATION

no-load. Note that this equation implies that the no-load current is a function of  $V_{IN}$ .

When  $V_{IN}$  is higher than the regulated  $V_{OUT}$  voltage, LT8336 enters PassThru operation and  $V_{OUT}$  is essentially shorted to  $V_{IN}$  by the inductor and M2. The converter quiescent current at no-load can be estimated using Equation 4.

$$I_Q \approx 45\mu A + \frac{V_{IN}}{R1 + R2} \quad (4)$$

where  $45\mu A$  is the sum of the  $V_{IN}$  pin and  $V_{OUT}$  pin quiescent current of the LT8336, and the second term is the current drawn by the feedback divider.

For a 25V  $V_{IN}$  with  $R1 = 1M$  and  $R2 = 43.2k$ , it can be calculated that the converter draws approximately  $70\mu A$  from the 25V supply at no-load.

When using large FB resistors, a 4.7pF to 22pF phase-lead capacitor should be connected from  $V_{OUT}$  to FB, and a careful evaluation of system stability should be made to ensure adequate design margin.

### Overvoltage Lockout

The  $V_{OUT}$  pin voltage is constantly monitored by the LT8336. An overvoltage condition occurs when  $V_{OUT}$  pin voltage exceeds approximately 40V. Switching is stopped at such condition. Normal switching is resumed when the  $V_{OUT}$  pin voltage drops back to 40V or lower.

### Switching Frequency Foldback when $V_{IN}$ Approaches $V_{OUT}$

In some applications,  $V_{IN}$  may rise to a voltage very close to  $V_{OUT}$ . In this condition the switching regulator must operate at a very low duty cycles to keep  $V_{OUT}$  in regulation. However, the minimum on-time limitation may prevent the switcher from attaining a sufficiently low duty cycle at the programmed switching frequency. As a result a typical boost converter may experience a large output ripple under these conditions. The LT8336 addresses this issue by adopting a switching frequency foldback function to smoothly decrease the switching frequency when its minimum on-time starts to limit the switcher from attaining a sufficiently low duty cycle. The typical switching

waveforms in these  $V_{IN}$  approaching  $V_{OUT}$  conditions are shown in the Typical Performance Characteristics section.

### Start-Up

To limit the peak switch current and  $V_{OUT}$  overshoot during start-up, the LT8336 contains internal circuitry to provide soft-start operation (refer to the error amplifier EA in Block Diagram). During start-up, the internal soft-start circuitry slowly ramps the internal SS signal from zero to 1V. When the SS voltage falls between the FB initial voltage and 1V, the LT8336 regulates the FB pin voltage to the SS voltage instead of 1V. In this way the output capacitor is charged gradually towards its final value while limiting the start-up peak switch currents.

Referring to Figure 2, the start-up time  $T_{START\_UP}$  is the time period from EN/UVLO transitioning high to PG transitioning high, indicating  $V_{OUT}$  has reached approximately 90% of its regulation voltage programmed by FB resistor network. When  $V_{IN} > 3.6V$ ,  $T_{START\_UP}$  is approximately given by Equation 5.

$$T_{START\_UP} = 0.25ms + \frac{2100}{f_{SW}} \quad (5)$$

When  $V_{IN} < 3.6V$ ,  $T_{START\_UP}$  is approximately given by Equation 6.

$$T_{START\_UP} = 0.25ms + \frac{3.5V}{V_{IN} - 0.1V} \cdot \frac{2100}{f_{SW}} \quad (6)$$

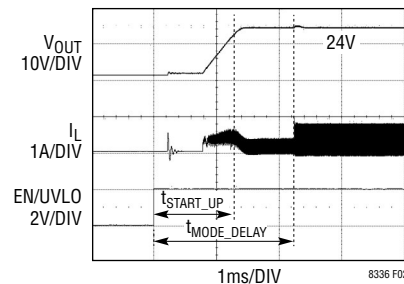

$V_{IN} = 12V$   
FRONT PAGE CIRCUIT

**Figure 2. Typical Start-Up Waveforms**

The LT8336 selects pulse-skipping mode with no spread spectrum frequency modulation during start-up, and the SYNC/MODE pin configuration is ignored. The LT8336

## APPLICATIONS INFORMATION

reads SYNC/MODE pin configuration after the start-up delay given by Equation 7.

$$T_{\text{MODE\_DELAY}} = 0.22\text{ms} + \frac{4096}{f_{\text{SW}}} \quad (7)$$

If the LT8336 boost converter is plugged into a live supply, the  $V_{\text{OUT}}$  could ring to twice the voltage of  $V_{\text{IN}}$ , due to the resonant circuit composed by  $L$ ,  $C_{\text{OUT}1-3}$ , and the body diode of M2 (refer to Block Diagram). If such over-shoot exceeds the  $V_{\text{OUT}}$  rating, it must be limited to protect the load and the converter. For these situations, a small Schottky diode or silicon diode can be connected between  $V_{\text{IN}}$  and  $V_{\text{OUT}}$  to deactivate the resonant circuit and limit the  $V_{\text{OUT}}$  over-shoot as shown in Figure 3. With the diode connected, the LT8336 boost is also more robust against output fault conditions such as output short circuit or overload, due to the fact that the diode diverts a great amount of output current from the LT8336. The diode can be rated for about one half to one fifth of the full load current since it only conducts current during start-up or output fault conditions.

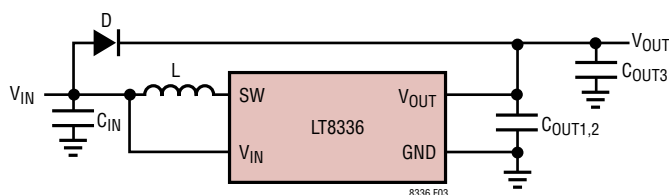

**Figure 3. A Simplified LT8336 Power Stage with a Diode Added Between  $V_{\text{IN}}$  and  $V_{\text{OUT}}$**

### Inductor Selection

When operating in continuous conduction mode (CCM), the duty cycle can be calculated based on the output voltage ( $V_{\text{OUT}}$ ) and the input voltage ( $V_{\text{IN}}$ ). The maximum duty cycle ( $D_{\text{MAX}}$ ) occurs when the converter has the minimum input voltage given by Equation 8.

$$D_{\text{MAX}} = \frac{V_{\text{OUT}} - V_{\text{IN(MIN)}}}{V_{\text{OUT}}} \quad (8)$$

Discontinuous conduction mode (DCM) provides higher conversion ratios at a given frequency at the cost of reduced efficiencies and higher switching currents.

The inductor ripple current  $\Delta I_{\text{SW}}$  has a direct effect on the choice of the inductor value, the converter's maximum output current capability, and the light load efficiency in Burst Mode operation. Choosing smaller values of  $\Delta I_{\text{SW}}$  increases output current capability and light load efficiency in Burst Mode operation, but require large inductance values and reduce the current loop gain. Accepting larger values of  $\Delta I_{\text{SW}}$  provides fast transient response and allows the use of low inductance values, but results in higher input current ripple, greater core losses, lower light load efficiency in Burst Mode operation, and lower output current capability. Large values of  $\Delta I_{\text{SW}}$  at high duty cycle operation may result in sub-harmonic oscillation.  $\Delta I_{\text{SW}} = 0.3\text{A}$  to  $0.6\text{A}$  generally provides a good starting value for many applications, and careful evaluation of system stability should be made to ensure adequate design margin.

Given an operating input voltage range, and having chosen the operating frequency and ripple current in the inductor, the inductor value of the boost converter can be determined using Equation 9.

$$L = \frac{V_{\text{IN(MIN)}}}{\Delta I_{\text{SW}} \cdot f_{\text{SW}}} \cdot D_{\text{MAX}} \quad (9)$$

The LT8336 limits the peak switch current in order to protect the switches and the system from overload faults. The bottom switch current limit is controlled to 3A (typical) regardless of the duty cycle. The peak inductor current is equal to the LT8336 bottom switch current limit. The user should choose an inductor with sufficient saturation and RMS current ratings to handle the inductor's peak current.

### Input Capacitor Selection

The input ripple current in a boost converter is relatively low (compared with the output ripple current), because this current is continuous. The voltage rating of the input capacitor,  $C_{\text{IN}}$ , should comfortably exceed the maximum input voltage. Although ceramic capacitors can be relatively tolerant of overvoltage conditions, aluminum electrolytic capacitors are not. Be sure to characterize the input voltage for any possible overvoltage transients that could apply excess stress to the input capacitors.

## APPLICATIONS INFORMATION

The value of  $C_{IN}$  is a function of the source impedance, and in general, the higher the source impedance, the higher the required input capacitance.

The RMS  $C_{IN}$  ripple current can be estimated by Equation 10.

$$I_{RMS(CIN)} = 0.3 \cdot \Delta I_L \quad (10)$$

### Output Capacitor Selection

The output capacitor has two essential functions. First, it filters the LT8336's discontinuous top switch current to produce the DC output. In this role, it determines the output ripple, thus low impedance at the switching frequency is important. The second function is to store energy in order to satisfy transient loads and stabilize the LT8336's control loop. The X5R or X7R type ceramic capacitors have very low equivalent series resistance (ESR), which provides low output ripple and good transient response. Transient performance can be improved with higher output capacitance and the addition of a feedforward capacitor placed between  $V_{OUT}$  and FB. When a feedforward capacitor is used or output capacitance is adjusted, a careful evaluation of system stability should be made to ensure adequate design margin. Increasing the output capacitance will also decrease the output voltage ripple. Lower value of output capacitance can be used to save space and cost, but transient performance will suffer and loop instability may result.

Besides the bulk output capacitors, two small output ceramic capacitors,  $1\mu\text{F}$  each, should be placed as close as possible to the IC to complete the Silent Switcher cancellation loops.

See the Board Layout section for more detail. XR7 or X5R capacitors are recommended for best performance across temperature and output voltage variations. Note that larger output capacitance is required when a lower switching frequency is used. If there is significant inductance to the load due to long wires or cables, additional bulk capacitance may be necessary. This can be provided

with an electrolytic capacitor. When choosing a capacitor, special attention should be given to capacitor's data sheet to calculate the effective capacitance under the relevant operating conditions of voltage bias and temperature. A physically larger capacitor, or one with a higher voltage rating, may be required. For good starting values, refer to the Typical Applications section.

### Board Layout

The LT8336 is specifically designed to minimize EMI emissions and also to maximize efficiency when switching at high frequencies. Figure 4 shows a recommended

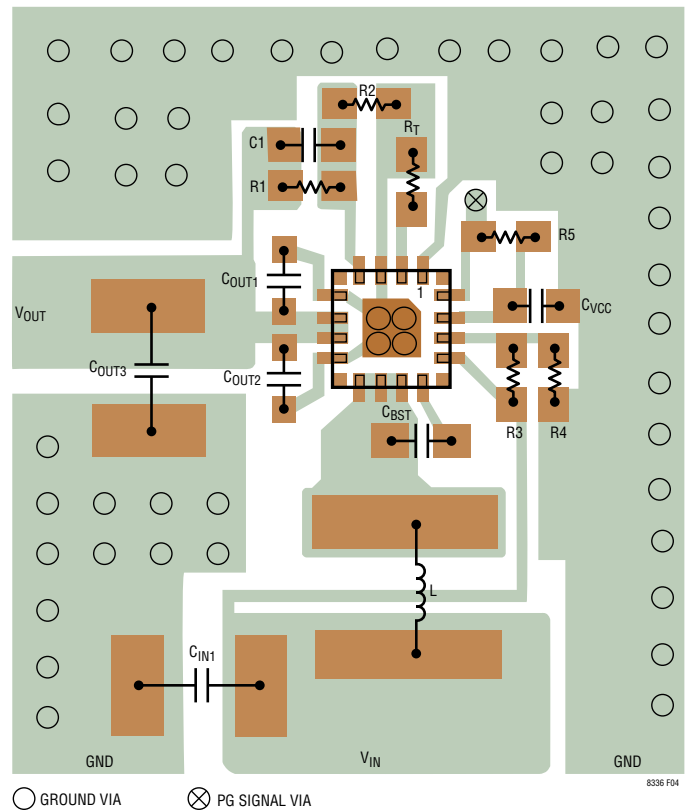

Figure 4. A Recommended PCB Layout for the LT8336



## APPLICATIONS INFORMATION

PCB layout. For more detail and PCB design files refer to the demo board guide for the LT8336.

For optimal performance the LT8336 requires the use of multiple  $V_{OUT}$  bypass capacitors. It is recommended to connect one  $1\mu\text{F}$  capacitor between  $V_{OUT}$  at Pin 6 and GND at Pin 5 only, and a matching  $1\mu\text{F}$  capacitor between  $V_{OUT}$  at Pin 7 and GND at Pin 8 only to complete the Silent Switcher EMI cancellation loops. These two capacitors must be placed as close as possible to the IC, and the loops formed by these two capacitors should be symmetrical and as small as possible to achieve an optimized EMI cancellation performance. Capacitors with small case size, such as 0402 or 0603, are optimal due to the low parasitic inductance. Additional bulk capacitors of  $2.2\mu\text{F}$  or more should be placed close to the IC with the positive terminals connected to  $V_{OUT}$ , and negative terminals connected to ground plane. The bypass capacitors for  $V_{IN}$  and  $\text{INTV}_{CC}$  pins should also be connected to the ground plane.

The output capacitors, along with the inductor and input capacitors, should be placed on the same side of the circuit board, and their connections should be made on that layer. Place a local, unbroken power ground plane under the application circuit on the layer closest to the surface layer. The SW and BST nodes should be as small as possible.

Keep the FB and RT nodes small so that the ground traces will shield them from the noise generated by the SW and BST nodes. It is recommended to use the GND at Pin 3 for the ground connection of the resistors connecting FB pin or RT Pin (refer to Figure 4).

The exposed pad on the bottom of the package should be soldered to the ground plane to reduce the package thermal resistance. To keep the thermal resistance low,

extend the ground plane as much as possible, and add many thermal vias to additional power ground planes within the circuit board.

### Thermal Considerations

Care should be taken in the layout of the PCB to ensure good heat sinking of the LT8336. The power ground plane should consist of large copper layers with thermal vias; these layers spread heat dissipated by the LT8336. Placing additional vias can reduce thermal resistance further. The maximum load current should be derated as the junction temperature approaches its maximum temperature rating. Power dissipation within the LT8336 can be estimated by calculating the total power loss from an efficiency measurement and subtracting the inductor loss. The junction temperature can be calculated by multiplying the total LT8336 power dissipation by the thermal resistance from junction to ambient and adding the ambient temperature. The LT8336 includes internal overtemperature protection that is intended to protect the device during momentary overload conditions. The overtemperature protection shuts down the LT8336 when the junction temperature exceeds  $170^{\circ}\text{C}$  (typ). The internal soft-start is triggered when the junction temperature drops below  $165^{\circ}\text{C}$  (typ). The maximum rated junction temperature is exceeded when this protection is active. Continuous operation above the specified absolute maximum operating junction temperature (see Absolute Maximum Ratings section) may impair device reliability or permanently damage the device.

## TYPICAL APPLICATIONS

Low I<sub>Q</sub>, Low EMI, 24V Output Boost Converter with SSFM\*

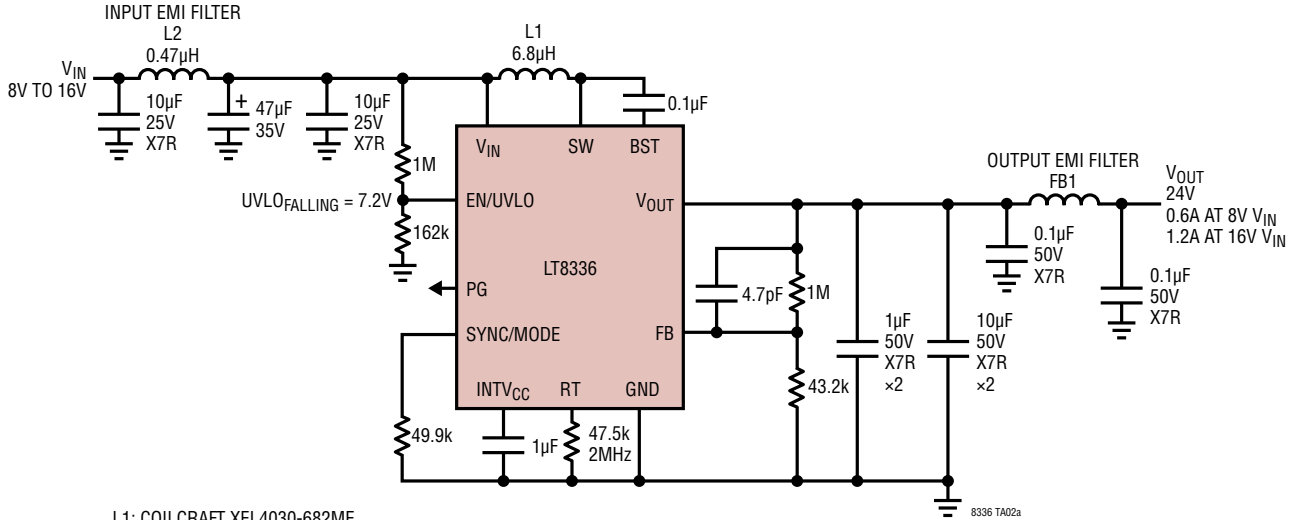

L1: COILCRAFT XEL4030-682ME

L2: WURTH ELEKTRONIK 74479299147

FB1: WURTH ELEKTRONIK 742792040

\*THIS CIRCUIT IS THE FRONT PAGE CIRCUIT WITH INPUT/OUTPUT FILTERS ADDED AND Burst Mode OPERATION WITH SSFM SELECTED. THE EMI PERFORMANCE IS SHOWN IN THE TYPICAL PERFORMANCE CHARACTERISTICS SECTION.

TYPICAL APPLICATIONS

8V to 16V Input, 36V Output Boost Converter

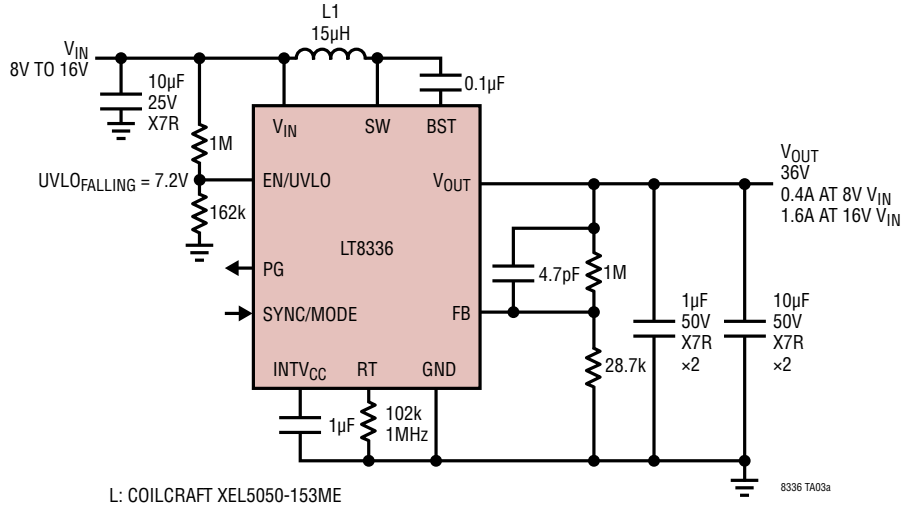

Efficiency and Power Loss vs Output Current

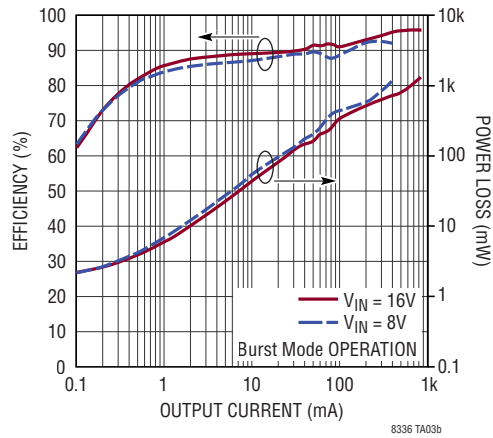

## TYPICAL APPLICATIONS

### 2.7V to 28V Input, 28V Output Boost Converter

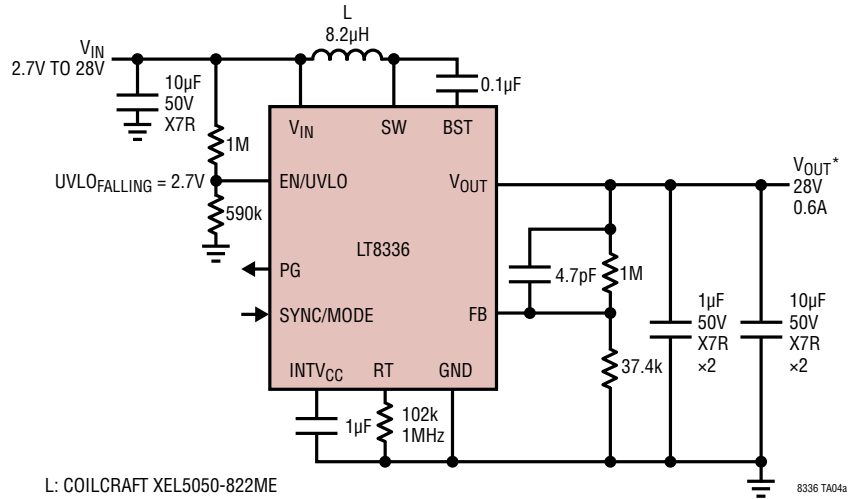

### Efficiency and Power Loss vs Output Current

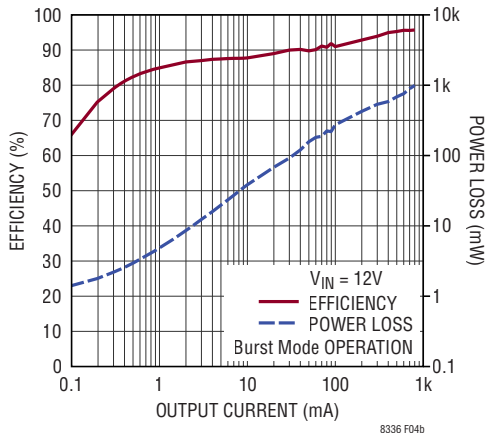

### Efficiency vs Input Voltage

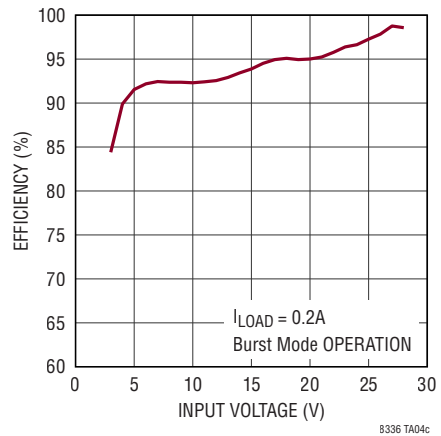

# TYPICAL APPLICATIONS

## Automotive Pre-Boost Converter for Stop-Start and Cold Crank with 20V Regulated Output and High Efficiency PassThru Mode

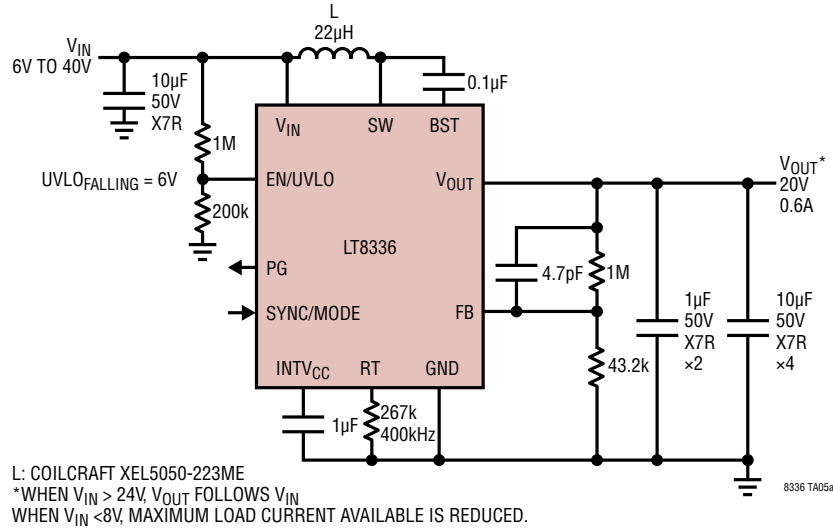

Efficiency and Power Loss vs Output Current

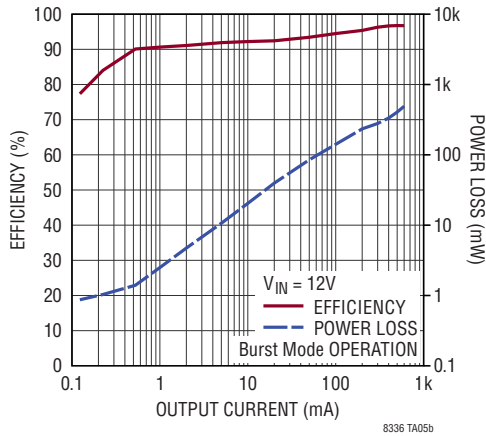

Efficiency vs Input Voltage

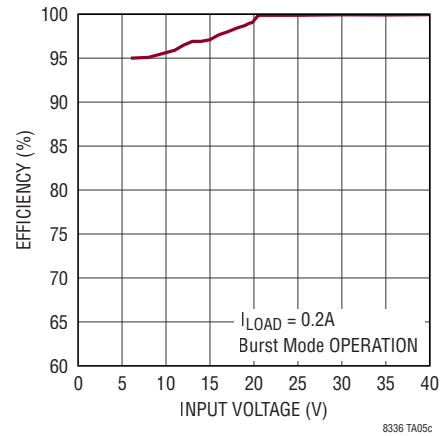

# PACKAGE DESCRIPTION

**LQFN Package**  
**16-Lead (3mm × 3mm × 0.94mm)**  
 (Reference LTC DWG # 05-08-1626 Rev A)

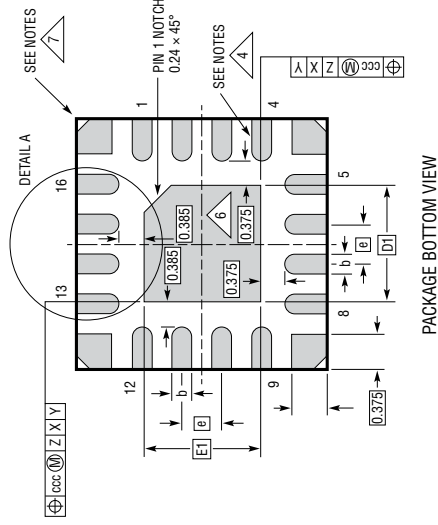

- NOTES:**
1. DIMENSIONING AND TOLERANCING PER ASME Y14.5M-1994
  2. ALL DIMENSIONS ARE IN MILLIMETERS
  3. PRIMARY DATUM -Z- IS SEATING PLANE
  4. METAL FEATURES UNDER THE SOLDER MASK OPENING NOT SHOWN SO AS NOT TO OBSCURE THESE TERMINALS AND HEAT FEATURES
  5. DETAILS OF PIN 1 IDENTIFIER ARE OPTIONAL, BUT MUST BE LOCATED WITHIN THE ZONE INDICATED. THE PIN 1 IDENTIFIER MAY BE EITHER A MOLD OR MARKED FEATURE
  6. THE EXPOSED HEAT FEATURE MAY HAVE OPTIONAL CORNER RADII
  7. CORNER SUPPORT PAD CHAMFER IS OPTIONAL

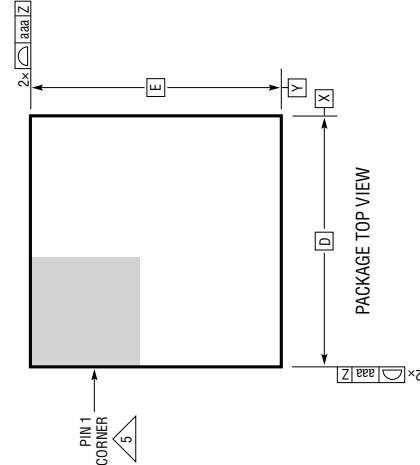
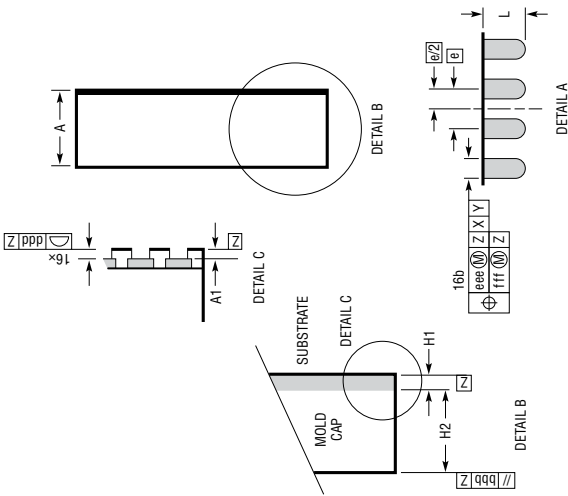
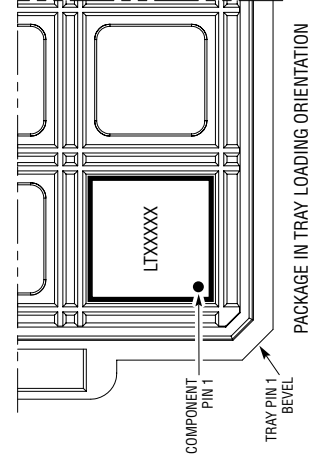

DIMENSIONS				
SYMBOL	MIN	NOM	MAX	NOTES
A	0.85	0.94	1.03	
A1	0.01	0.02	0.03	
L	0.30	0.40	0.50	
b	0.22	0.25	0.28	
D		3.00		
E		3.00		
D1		1.44		
E1		1.44		
e		0.50		
H1		0.24 REF		SUBSTRATE THK
H2		0.70 REF		MOLD CAP HT
aaa			0.10	
bbb			0.10	
ccc			0.10	
ddd			0.10	
eee			0.15	
fff			0.08	

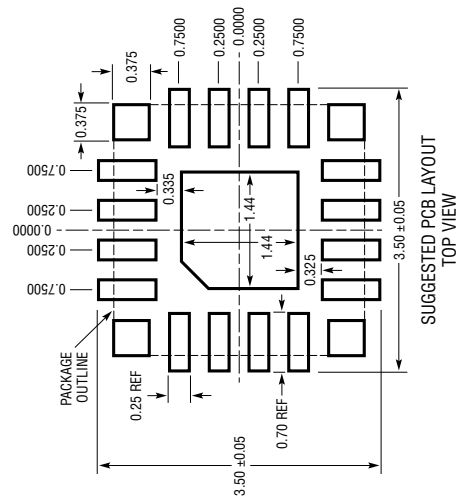

**REVISION HISTORY**

REV	DATE	DESCRIPTION	PAGE NUMBER
A	11/21	Updated all instances of Pass Through mode to trademarked PassThru.	1-3, 6, 8, 10, 13-14, 20, 22
		Added patent reference.	1
		Updated AEC-Q100 qualification status.	1
		Added <i>with PassThru</i> into Part Title.	1
		Clarified titling on typical graph G24.	6
		Updated graph descriptions.	7
		Updated SYNC/MODE pin description.	8
		Removed erroneous pin number.	9
		Updated operating description.	10, 16
		Edited typical $V_{IN}$ quiescent current.	11
		Edited Equation 1 reference to $V_{IN}$ .	11
		Edited frequency foldback description.	14
		Added LT8337/LT8337-1 to Related Parts section.	22

## TYPICAL APPLICATION

### Automotive Pre-Boost Converter for Stop-Start and Cold Crank with 10V Regulated Output and High Efficiency PassThru Mode

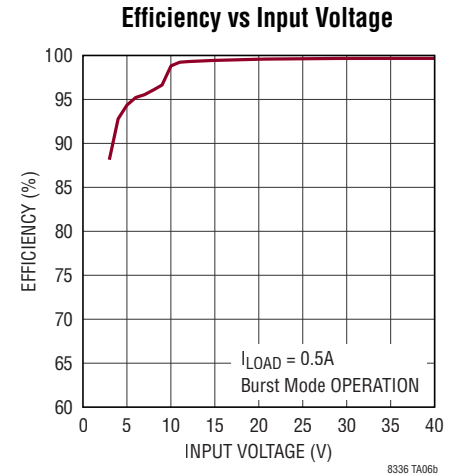
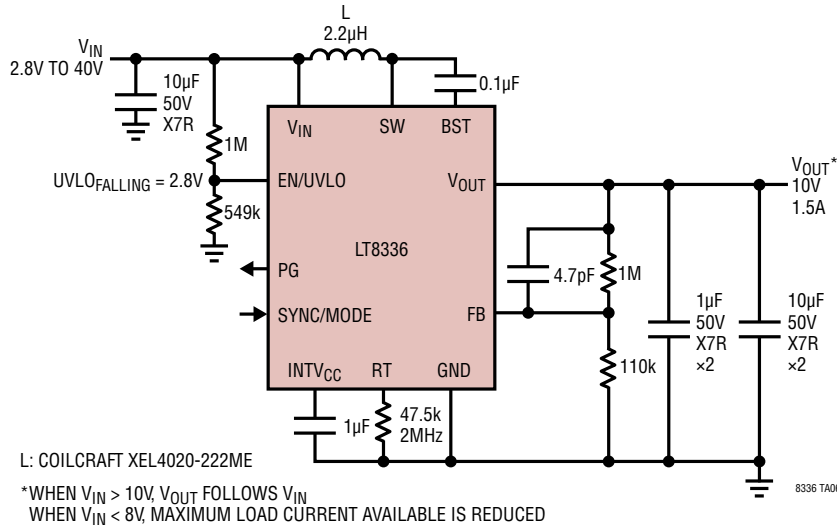

## RELATED PARTS

PART NUMBER	DESCRIPTION	COMMENTS
<a href="#">LT8330</a>	1A ( $I_{SW}$ ), 60V, 2MHz High Efficiency Boost/SEPIC/Inverting DC/DC Converter	$V_{IN} = 3V$ to 40V, $V_{OUT(MAX)} = 60V$ , $I_Q = 6\mu A$ (Burst Mode Operation), $I_{SD} < 1\mu A$ , ThinSOT, 2mm $\times$ 3mm DFN Packages
<a href="#">LT8331</a>	0.5A ( $I_{SW}$ ), 140V, 500kHz High Efficiency Boost/Flyback/SEPIC/Inverting DC/DC Converter	$V_{IN} = 4.5V$ to 100V, $V_{OUT(MAX)} = 135V$ , $I_Q = 6\mu A$ (Burst Mode Operation), $I_{SD} < 1\mu A$ , MSOP-16(12)E
<a href="#">LT8337/LT8337-1</a>	28V, 5A, Low $I_Q$ Synchronous Step-Up Silent Switcher with PassThru	$V_{IN} = 2.7V$ to 28V, $V_{OUT(MAX)} = 28V$ , $V_{IN}$ Pin $I_Q = 4\mu A$ (Burst Mode Operation), 3mm $\times$ 3mm LQFN package
<a href="#">LT3957A/LT3957</a>	Boost, Flyback, SEPIC and Inverting Converter with 5A/40V Switch	$3V \leq V_{IN} \leq 40V$ , Current Mode Control, 100kHz to 1MHz Programmable Operation Frequency, 5mm $\times$ 6mm QFN-36 Package
<a href="#">LT3958</a>	High Input Voltage, Boost, Flyback, SEPIC and Inverting Converter with 3.5A/80V Switch	$5V \leq V_{IN} < 80V$ , Current Mode Control, 100kHz to 1MHz Programmable Operation Frequency, 5mm $\times$ 6mm QFN-36 Package
<a href="#">LT8335</a>	28V, 2A, Low $I_Q$ Boost/SEPIC/Inverting 2MHz Converter	$V_{IN} = 3V$ to 25V, $V_{OUT(MAX)} = 25V$ , $I_Q = 6\mu A$ (Burst Mode Operation), 3mm $\times$ 2mm DFN Package
<a href="#">LT8362</a>	60V, 2A, Low $I_Q$ Boost/SEPIC/Inverting 2MHz Converter	$V_{IN} = 2.8V$ to 60V, $V_{OUT(MAX)} = 60V$ , $I_Q = 9\mu A$ (Burst Mode Operation), MSOP-16(12)E, 3mm $\times$ 3mm DFN-10 Packages
<a href="#">LT8364</a>	60V, 4A, Low $I_Q$ Boost/SEPIC/Inverting 2MHz Converter	$V_{IN} = 2.8V$ to 60V, $V_{OUT(MAX)} = 60V$ , $I_Q = 9\mu A$ (Burst Mode Operation), MSOP-16(12)E, 4mm $\times$ 3mm DFN-12 Packages
<a href="#">LT8494</a>	70V, 2A Boost/SEPIC 1.5MHz High Efficiency Step-Up DC/DC Converter	$V_{IN} = 1V$ to 60V (2.5V to 32V Start-Up), $V_{OUT(MAX)} = 70V$ , $I_Q = 3\mu A$ (Burst Mode Operation), $I_{SD} < 1\mu A$ , 20-Lead TSSOP
<a href="#">LT8580</a>	1A ( $I_{SW}$ ), 65V 1.5MHz, High Efficiency Step-Up DC/DC Converter	$V_{IN}: 2.55V$ to 40V, $V_{OUT(MAX)} = 65V$ , $I_Q = 1.2mA$ , $I_{SD} < 1\mu A$ , 3mm $\times$ 3mm DFN-8, MSOP-8E



## X-ON Electronics

Largest Supplier of Electrical and Electronic Components

*Click to view similar products for [Switching Voltage Regulators](#) category:*

*Click to view products by [Analog Devices](#) manufacturer:*

Other Similar products are found below :

[FAN53610AUC33X](#) [FAN53611AUC123X](#) [FAN48610BUC33X](#) [FAN48610BUC45X](#) [FAN48617UC50X](#) [R3](#) [430464BB](#) [KE177614](#)  
[FAN53611AUC12X](#) [MAX809TTR](#) [NCV891234MW50R2G](#) [NCP81103MNTXG](#) [NCP81203PMNTXG](#) [NCP81208MNTXG](#)  
[NCP81109GMNTXG](#) [SCY1751FCCT1G](#) [NCP81109JMNTXG](#) [AP3409ADNTR-G1](#) [NCP81241MNTXG](#) [LTM8064IY](#) [LT8315EFE#TRPBF](#)  
[LTM4664EY#PBF](#) [LTM4668AIY#PBF](#) [NCV1077CSTBT3G](#) [XCL207A123CR-G](#) [MPM54304GMN-0002](#) [MPM54304GMN-0004](#)  
[MPM54304GMN-0003](#) [AP62300Z6-7](#) [MP8757GL-P](#) [MIC23356YFT-TR](#) [LD8116CGL](#) [HG2269M/TR](#) [OB2269](#) [XD3526](#) [U6215A](#) [U6215B](#)  
[U6620S](#) [LTC3412IFE](#) [LT1425IS](#) [MAX25203BATJA/VY+](#) [MAX77874CEWM+](#) [XC9236D08CER-G](#) [MP3416GJ-P](#) [BD9S201NUX-CE2](#)  
[MP5461GC-Z](#) [MPQ4415AGQB-Z](#) [MPQ4590GS-Z](#) [MAX38640BENT18+T](#) [MAX77511AEWB+](#)