

FEATURES

- 8th Order Elliptic Filter in SO-8 Package
- Single 3V Operation: Supply Current: 1mA (Typ)
 f_{CUTOFF} : 14kHz (Max) S/N Ratio: 72dB
- Single 5V Operation: Supply Current: 1.2mA (Typ)
 f_{CUTOFF} : 20kHz (Max) S/N Ratio: 79dB
- ± 0.1 dB Passband Ripple Up to $0.9f_{\text{CUTOFF}}$ (Typ)
- 42dB Attenuation at $1.3f_{\text{CUTOFF}}$
- 66dB Attenuation at $2.0f_{\text{CUTOFF}}$
- 70dB Attenuation at $2.1f_{\text{CUTOFF}}$
- Wide Dynamic Range, 75dB or More (S/N + THD), Under Single 5V Operation
- Wideband Noise: $120\mu\text{V}_{\text{RMS}}$
- Clock-to- f_{CUTOFF} Ratio: 50:1
- Internal Sample Rate: 100:1

APPLICATIONS

- Handheld Instruments
- Telecommunication Filters
- Antialiasing Filters
- Smoothing Filters
- Audio
- Multimedia

LT, LT, LTC and LTM are registered trademarks of Linear Technology Corporation.

DESCRIPTION

The LTC[®]1069-6 is a monolithic low power, 8th order lowpass filter optimized for single 3V or single 5V supply operation. The LTC1069-6 typically consumes 1mA under single 3V supply operation and 1.2mA under 5V operation.

The cutoff frequency of the LTC1069-6 is clock tunable and it is equal to the clock frequency divided by 50. The input signal is sampled twice per clock cycle to lower the risk of aliasing.

The typical passband ripple is ± 0.1 dB up to $0.9f_{\text{CUTOFF}}$. The gain at f_{CUTOFF} is -0.7 dB. The transition band of the LTC1069-6 features progressive attenuation reaching 42dB at $1.3f_{\text{CUTOFF}}$ and 70dB at $2.1f_{\text{CUTOFF}}$. The maximum stopband attenuation is 72dB.

The LTC1069-6 can be clock tuned for cutoff frequencies up to 20kHz (single 5V supply) and for cutoff frequencies up to 14kHz (single 3V supply).

The low power feature of the LTC1069-6 does not penalize the device's dynamic range. With single 5V supply and an input range of 0.4V_{RMS} to 1.4V_{RMS} , the Signal-to-(Noise + THD) ratio is ≥ 70 dB. The wideband noise of the LTC1069-6 is $125\mu\text{V}_{\text{RMS}}$.

Other filter responses with higher speed can be obtained. Please contact LTC Marketing for details.

The LTC1069-6 is available in an 8-pin SO package.

TYPICAL APPLICATION

Single 3V Supply 10kHz Elliptic Lowpass Filter

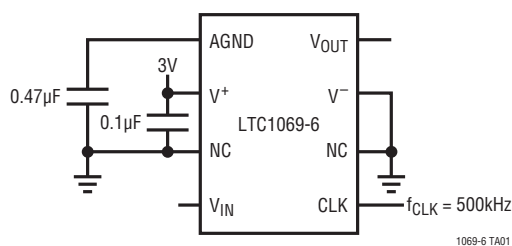

Frequency Response

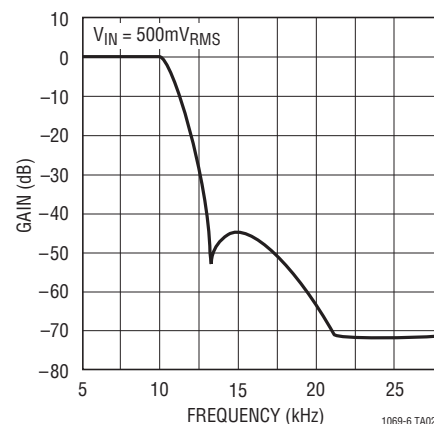

10696fa

ABSOLUTE MAXIMUM RATINGS

Total Supply Voltage (V^+ to V^-)	12V
Operating Temperature Range	
LTC1069-6C	0°C to 70°C
LTC1069-6I	-40°C to 85°C
Storage Temperature.....	-65°C to 150°C
Lead Temperature (Soldering, 10 sec)	300°C

PIN CONFIGURATION

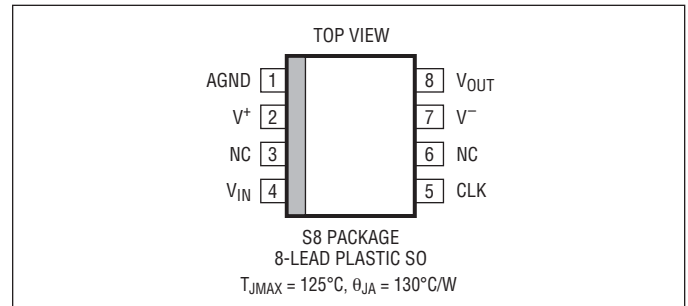

ORDER INFORMATION

LEAD FREE FINISH	TAPE AND REEL	PART MARKING	PACKAGE DESCRIPTION	TEMPERATURE RANGE
LTC1069-6CS8#PBF	LTC1069-6CS8#TRPBF	10696	8-Lead Plastic SO	0°C to 70°C
LTC1069-6IS8#PBF	LTC1069-6IS8#TRPBF	10696I	8-Lead Plastic SO	-40°C to 85°C

Consult LTC Marketing for parts specified with wider operating temperature ranges.

Consult LTC Marketing for information on non-standard lead based finish parts.

For more information on lead free part marking, go to: <http://www.linear.com/leadfree/>

For more information on tape and reel specifications, go to: <http://www.linear.com/tapeandree/>

ELECTRICAL CHARACTERISTICS The ● denotes the specifications which apply over the full operating temperature range. f_{CUTOFF} is the filter's cutoff frequency and is equal to $f_{CLK}/50$. The f_{CLK} signal level is TTL or CMOS (clock rise or fall time $\leq 1\mu s$) $R_L = 10k$, $V_S = 5V$, $T_A = 25^\circ C$, unless otherwise specified. All AC gains are measured relative to the passband gain.

SYMBOL	CONDITIONS	MIN	TYP	MAX	UNITS
Passband Gain ($f_{IN} \leq 0.2f_{CUTOFF}$)	$V_S = 5V$, $f_{CLK} = 200kHz$ $f_{TEST} = 0.25kHz$, $V_{IN} = 1V_{RMS}$	● -0.25 -0.30	0.1 0.1	0.45 0.50	db db
	$V_S = 3V$, $f_{CLK} = 200kHz$ $f_{TEST} = 0.25kHz$, $V_{IN} = 0.5V_{RMS}$	● -0.25 -0.30	0.1 0.1	0.45 0.50	db db
Gain at $0.50f_{CUTOFF}$	$V_S = 5V$, $f_{CLK} = 200kHz$ $f_{TEST} = 2.0kHz$, $V_{IN} = 1V_{RMS}$	● -0.10 -0.15	0.07 0.07	0.25 0.30	db db
	$V_S = 3V$, $f_{CLK} = 200kHz$ $f_{TEST} = 2.0kHz$, $V_{IN} = 0.5V_{RMS}$	● -0.15 -0.20	0.07 0.07	0.25 0.30	db db
Gain at $0.75f_{CUTOFF}$	$V_S = 5V$, $f_{CLK} = 200kHz$ $f_{TEST} = 3.0kHz$, $V_{IN} = 1V_{RMS}$	● -0.25 -0.30	0 0	0.25 0.30	db db
	$V_S = 3V$, $f_{CLK} = 200kHz$ $f_{TEST} = 3.0kHz$, $V_{IN} = 0.5V_{RMS}$	● -0.25 -0.30	0 0	0.25 0.30	db db
Gain at $0.90f_{CUTOFF}$	$V_S = 5V$, $f_{CLK} = 200kHz$ $f_{TEST} = 3.6kHz$, $V_{IN} = 1V_{RMS}$	● -0.25 -0.25	0.1 0.1	0.45 0.45	db db
	$V_S = 3V$, $f_{CLK} = 200kHz$ $f_{TEST} = 3.6kHz$, $V_{IN} = 0.5V_{RMS}$	● -0.25 -0.30	0.1 0.1	0.45 0.50	db db
Gain at $0.95f_{CUTOFF}$	$V_S = 5V$, $f_{CLK} = 200kHz$ $f_{TEST} = 3.8kHz$, $V_{IN} = 1V_{RMS}$	● -0.35 -0.45	0.05 0.05	0.25 0.25	db db
	$V_S = 3V$, $f_{CLK} = 200kHz$ $f_{TEST} = 3.8kHz$, $V_{IN} = 0.5V_{RMS}$	● -0.45 -0.55	0.05 0.05	0.25 0.35	db db

ELECTRICAL CHARACTERISTICS The ● denotes the specifications which apply over the full operating temperature range. f_{CUTOFF} is the filter's cutoff frequency and is equal to $f_{\text{CLK}}/50$. The f_{CLK} signal level is TTL or CMOS (clock rise or fall time $\leq 1\mu\text{s}$) $R_L = 10\text{k}$, $V_S = 5\text{V}$, $T_A = 25^\circ\text{C}$, unless otherwise specified. All AC gains are measured relative to the passband gain.

SYMBOL	CONDITIONS	MIN	TYP	MAX	UNITS	
Gain at f_{CUTOFF}	$V_S = 5\text{V}$, $f_{\text{CLK}} = 200\text{kHz}$ $f_{\text{TEST}} = 4.0\text{kHz}$, $V_{\text{IN}} = 1V_{\text{RMS}}$	● -1.50 -1.65	-0.07 -0.07	-0.20 -0.25	db db	
	$V_S = 3\text{V}$, $f_{\text{CLK}} = 200\text{kHz}$ $f_{\text{TEST}} = 4.0\text{kHz}$, $V_{\text{IN}} = 0.5V_{\text{RMS}}$	● -1.5 -1.7	-0.07 -0.07	0 0	db db	
Gain at $1.30f_{\text{CUTOFF}}$	$V_S = 5\text{V}$, $f_{\text{CLK}} = 200\text{kHz}$ $f_{\text{TEST}} = 5.2\text{kHz}$, $V_{\text{IN}} = 1V_{\text{RMS}}$	●	-42 -42	-40 -39	db db	
	$V_S = 3\text{V}$, $f_{\text{CLK}} = 200\text{kHz}$ $f_{\text{TEST}} = 5.2\text{kHz}$, $V_{\text{IN}} = 0.5V_{\text{RMS}}$	●	-41 -41	-38 -37	db db	
Gain at $2.00f_{\text{CUTOFF}}$	$V_S = 5\text{V}$, $f_{\text{CLK}} = 200\text{kHz}$ $f_{\text{TEST}} = 8.0\text{kHz}$, $V_{\text{IN}} = 1V_{\text{RMS}}$	●	-66 -66	-61 -60	db db	
	$V_S = 3\text{V}$, $f_{\text{CLK}} = 200\text{kHz}$ $f_{\text{TEST}} = 8.0\text{kHz}$, $V_{\text{IN}} = 0.5V_{\text{RMS}}$	●	-66 -66	-60 -59	db dB	
Gain at $0.95f_{\text{CUTOFF}}$	$V_S = 5\text{V}$, $f_{\text{CLK}} = 400\text{kHz}$, $f_{\text{TEST}} = 7.6\text{kHz}$, $V_{\text{IN}} = 1V_{\text{RMS}}$ $V_S = 3\text{V}$, $f_{\text{CLK}} = 400\text{kHz}$, $f_{\text{TEST}} = 7.6\text{kHz}$, $V_{\text{IN}} = 0.5V_{\text{RMS}}$		-0.5 -0.5	0.15 0	0.5 0.5	db db
	Output DC Offset (Note 1)	$V_S = 5\text{V}$, $f_{\text{CLK}} = 100\text{kHz}$ $V_S = 3\text{V}$, $f_{\text{CLK}} = 100\text{kHz}$		50 30	175 135	mV mV
Output DC Offset Tempco	$V_S = 5\text{V}$, $V_S = 3\text{V}$		30		$\mu\text{V}/^\circ\text{C}$	
Output Voltage Swing (Note 2)	$V_S = 5\text{V}$, $f_{\text{CLK}} = 100\text{kHz}$	● 3.4 3.2	4.2 4.2		$V_{\text{P-P}}$ $V_{\text{P-P}}$	
	$V_S = 3\text{V}$, $f_{\text{CLK}} = 100\text{kHz}$	● 1.6 1.6	2.0 2.0		$V_{\text{P-P}}$ $V_{\text{P-P}}$	
Power Supply Current	$V_S = 5\text{V}$, $f_{\text{CLK}} = 100\text{kHz}$	●	1.2	1.60 1.65	mA mA	
	$V_S = 3\text{V}$, $f_{\text{CLK}} = 100\text{kHz}$	●	1	1.40 1.55	mA mA	
Maximum Clock Frequency	$V_S = 5\text{V}$ $V_S = 3\text{V}$		1 0.7		MHz MHz	
	Input Frequency Range		0	$<(f_{\text{CLK}} - 2f_c)$		
Input Resistance		35	50	80	$\text{k}\Omega$	
Operating Supply Voltage (Note 3)		3		10	V	

Note 1: Stresses beyond those listed under Absolute Maximum Ratings may cause permanent damage to the device. Exposure to any Absolute Maximum Rating condition for extended periods may affect device reliability and lifetime.

Note 2: The input offset voltage is measured with respect to AGND (Pin 1). The input (Pin 4) is also shorted to the AGND pin. The analog ground pin potential is internally set to $(0.437)(V_{\text{SUPPLY}})$.

Note 3: The input voltage can swing to either rail (V^+ or ground); the output typically swings 50mV from ground and 0.8V from V^+ .

Note 4: The LTC1069-6 is optimized for 3V and 5V operation. Although the device can operate with a single 10V supply or $\pm 5\text{V}$, the total harmonic distortion will be degraded. For single 10V or $\pm 5\text{V}$ supply operation we recommend to use the LTC1069-1.

TYPICAL PERFORMANCE CHARACTERISTICS

Passband Gain vs Frequency

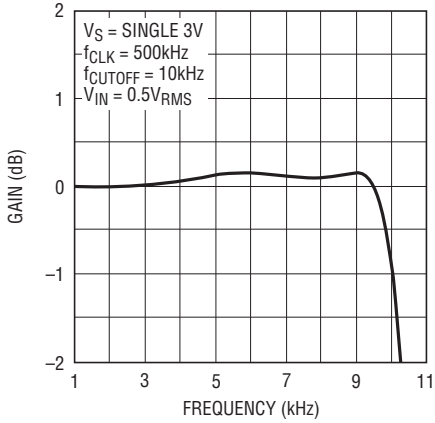

1069-6 G01

Transition Band Gain vs Frequency

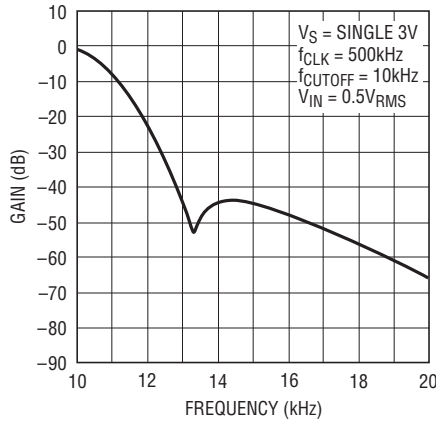

1069-6 G02

Stopband Gain vs Frequency

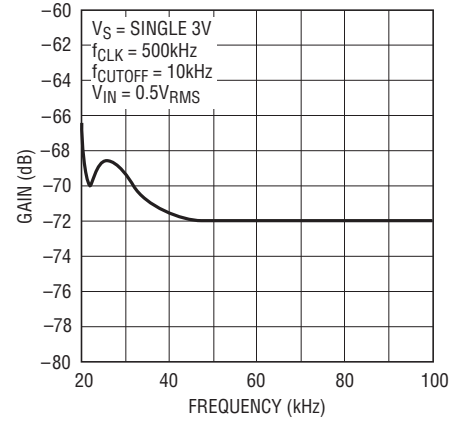

1069-6 G03

Passband Gain vs Clock Frequency

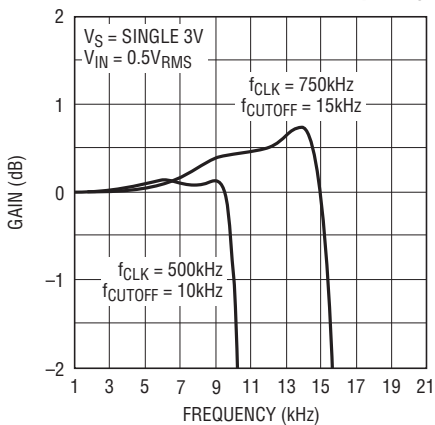

1069-6 G04

Passband Gain vs Clock Frequency

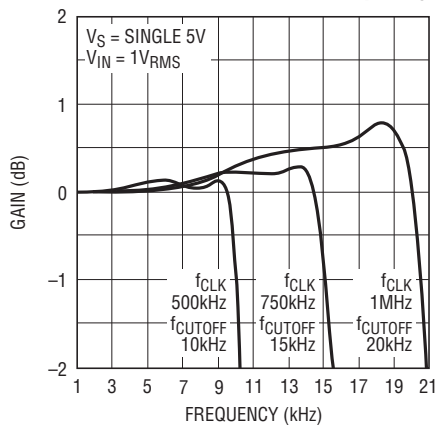

1069-6 G05

Amplitude Response vs Supply Voltage

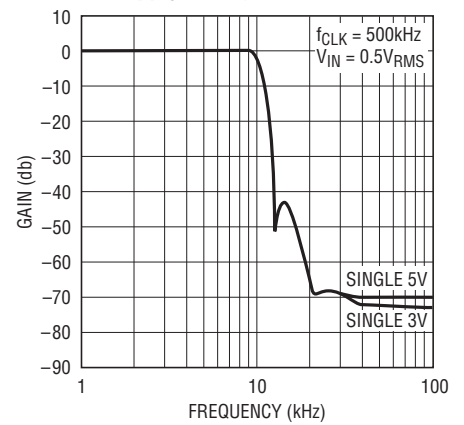

1069-6 G06

Phase vs Frequency

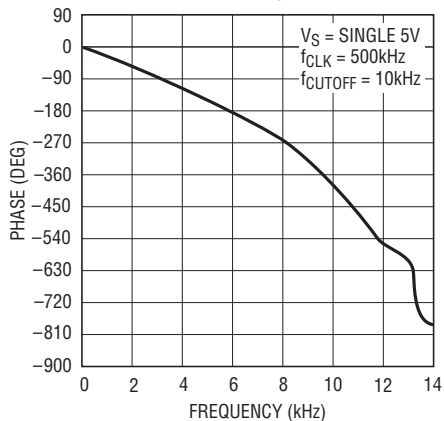

1069-6 G07

Group Delay vs Frequency

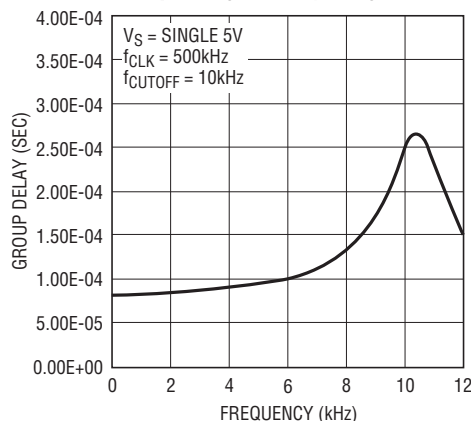

1069-6 G08

Transient Response

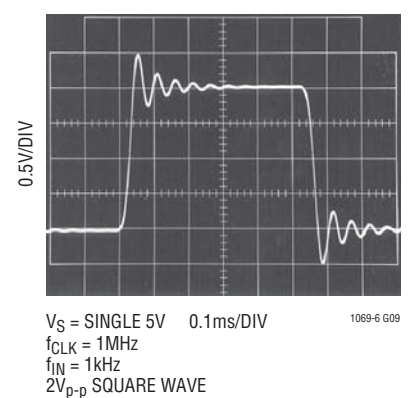

1069-6 G09

TYPICAL PERFORMANCE CHARACTERISTICS

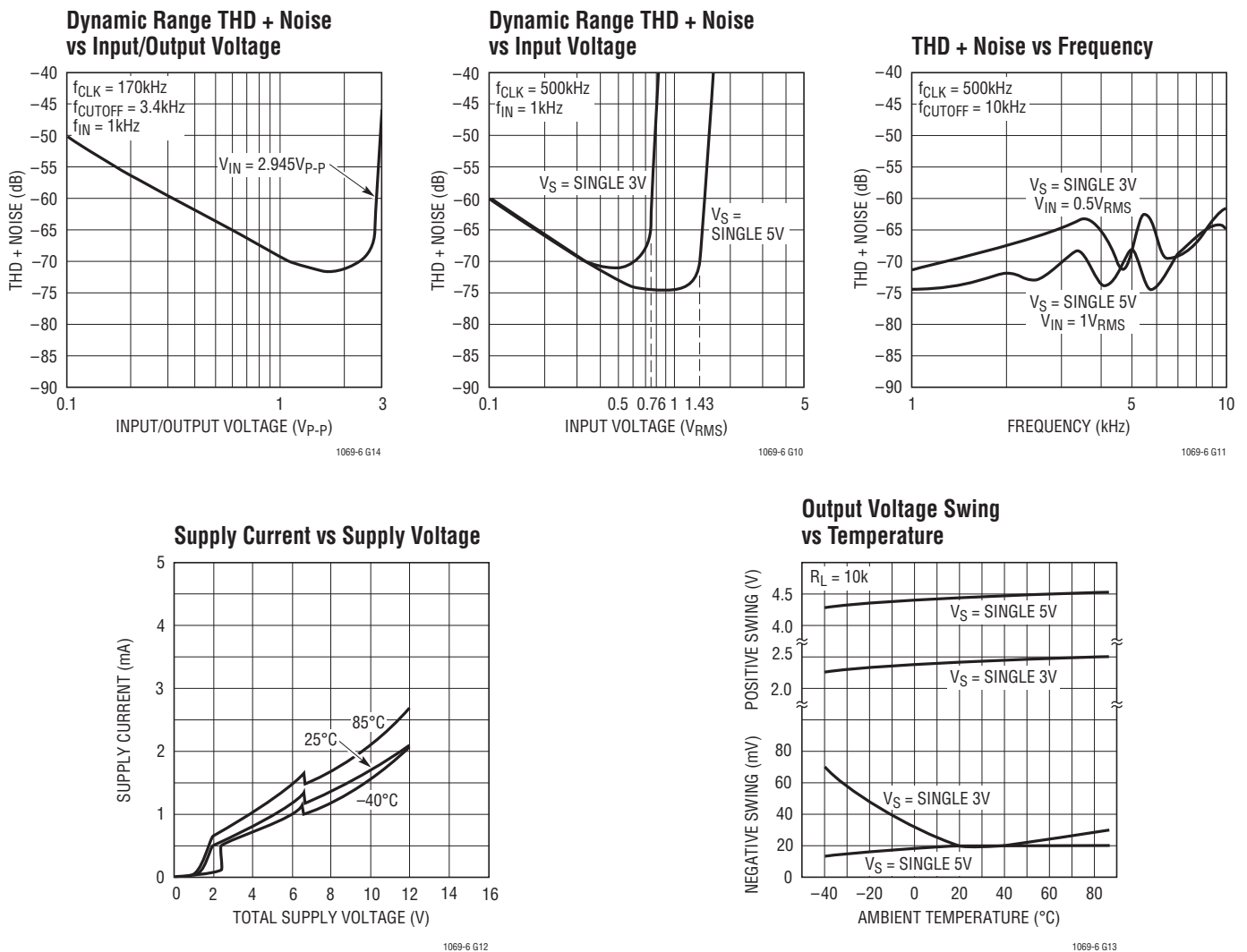

PIN FUNCTIONS

AGND (Pin 1): Analog Ground. The quality of the analog signal ground can affect the filter performance. For either single or dual supply operation, an analog ground plane surrounding the package is recommended. The analog ground plane should be connected to any digital ground at a single point. For single supply operation, Pin 1 should be bypassed to the analog ground plane with a $0.47\mu F$ capacitor or larger. An internal resistive divider biases Pin 1 to 0.4366 times the total power supply of the device (Figure 1). That is, with a single 5V supply, the potential at Pin 1 is $2.183V \pm 1\%$. As the LTC1069-6 is optimized

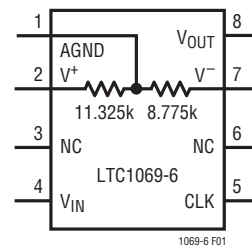

Figure 1. Internal Biasing of the Analog Ground (Pin 1)

PIN FUNCTIONS

for single supply operation, the internal biasing of Pin 1 allows optimum output swing. The AGND pin should be buffered if used to bias other ICs. Figure 2 shows the connections for single supply operation.

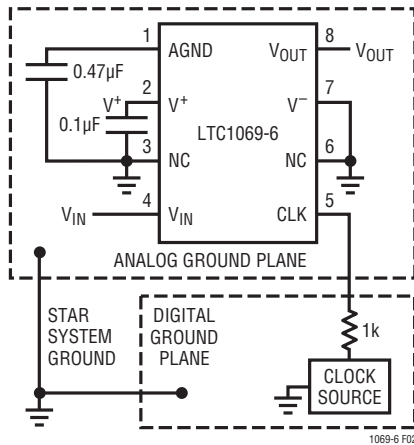

Figure 2. Connections for Single Supply Operation

V⁺, V⁻ (Pins 2, 7): Power Supply Pins. The V⁺ (Pin 2) and the V⁻ (Pin 7, if used) should be bypassed with a 0.1µF capacitor to an adequate analog ground. The filter's power supplies should be isolated from other digital or high voltage analog supplies. A low noise linear supply is recommended. Switching power supplies will lower the signal-to-noise ratio of the filter. Unlike previous monolithic filters, the power supplies can be applied in any order, that is, the positive supply can be applied before the negative supply and vice versa. Figure 3 shows the connection for dual supply operation.

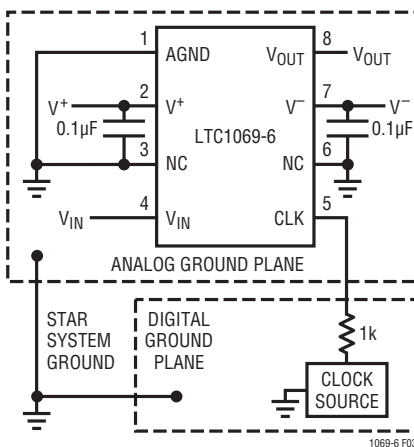

Figure 3. Connections for Dual Supply Operation

NC (Pins 3, 6): No Connection. Pins 3 and 6 are not connected to any internal circuitry; they should be tied to ground.

V_{IN} (Pin 4): Filter Input Pin. The Filter Input pin is internally connected to the inverting input of an op amp through a 50k resistor.

CLK (Pin 5): Clock Input Pin. Any TTL or CMOS clock source with a square wave output and 50% duty cycle ($\pm 10\%$) is an adequate clock source for the device. The power supply for the clock source should not necessarily be the filter's power supply. The analog ground of the filter should be connected to the clock's ground at a single point only. Table 1 shows the clock's low and high level threshold value for a dual or single supply operation. A pulse generator can be used as a clock source provided the high level ON time is greater than $0.42\mu\text{s}$ ($V_S = \pm 5\text{V}$). Sine waves less than 100kHz are not recommended for clock frequencies because, excessive slow clock rise or fall times generate internal clock jitter. The maximum clock rise or fall time is $1\mu\text{s}$. The clock signal should be routed from the right side of the IC package to avoid coupling into any input or output analog signal path. A 1k resistor between the clock source and the Clock Input (Pin 5) will slow down the rise and fall times of the clock to further reduce charge coupling (Figure 1).

Table 1. Clock Source High and Low Thresholds

POWER SUPPLY	HIGH LEVEL	LOW LEVEL
Dual Supply = $\pm 5\text{V}$	1.5V	0.5V
Single Supply = 10V	6.5V	5.5V
Single Supply = 5V	1.5V	0.5V
Single Supply = 3.3V	1.2V	0.5V

V_{OUT} (Pin 8): Filter Output Pin. Pin 8 is the output of the filter, and it can source 8mA or sink 1mA. The total harmonic distortion of the filter will degrade when driving coaxial cables or loads less than 20k without an output buffer.

APPLICATIONS INFORMATION

Temperature Behavior

The power supply current of the LTC1069-6 has a positive temperature coefficient. The GBW product of its internal op amps is nearly constant and the speed of the device does not degrade at high temperatures. Figures 4a, 4b and 4c show the behavior of the passband of the device for various supplies and temperatures. The filter has a passband behavior which is temperature independent.

Clock Feedthrough

The clock feedthrough is defined as the RMS value of the clock frequency and its harmonics that are present at the filter's Output (Pin 8). The clock feedthrough is tested with the Input (Pin 4) shorted to AGND (Pin 1) and depends on PC board layout and on the value of the power supplies. With proper layout techniques the values of the clock feedthrough are shown in Table 2.

Table 2. Clock Feedthrough

V_S	CLOCK FEEDTHROUGH
3.3V	100 μ V _{RMS}
5V	170 μ V _{RMS}
10V	350 μ V _{RMS}

Any parasitic switching transients during the rising and falling edges of the incoming clock are not part of the clock feedthrough specifications. Switching transients have frequency contents much higher than the applied clock; their amplitude strongly depends on scope probing techniques as well as grounding and power supply bypassing. The clock feedthrough can be reduced by adding a single RC lowpass filter at the Output (Pin 8).

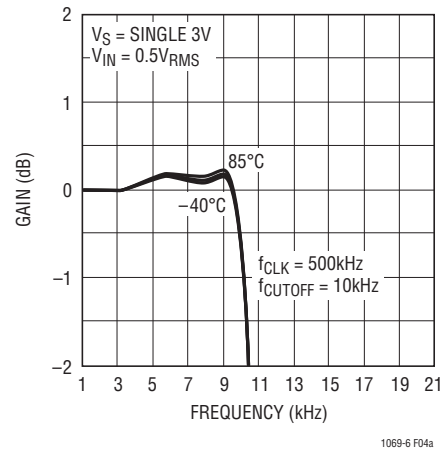

Figure 4a

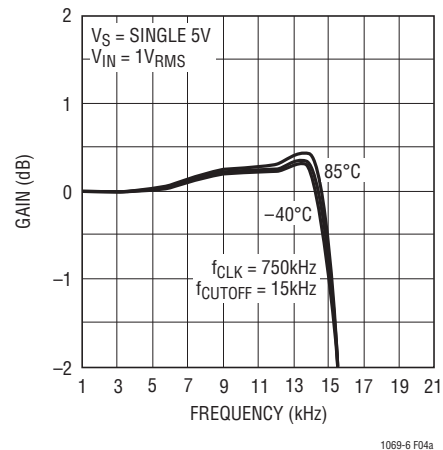

Figure 4b

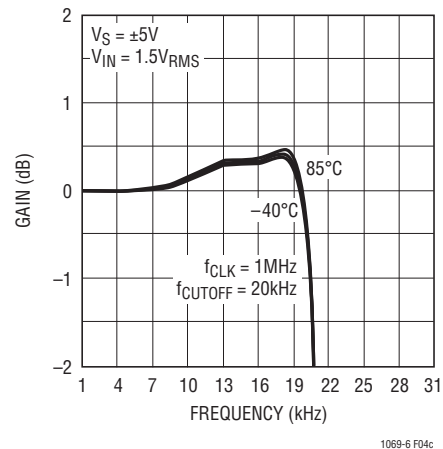

Figure 4c

APPLICATIONS INFORMATION

Wideband Noise

The wideband noise of the filter is the total RMS value of the device's noise spectral density and determines the operating signal-to-noise ratio. The frequency contents of the wideband noise lie within the filter's passband. The wideband noise cannot be reduced by adding post filtering. The total wideband noise is nearly independent of the clock frequency and depends slightly on the power supply voltage (see Table 3). The clock feedthrough specifications are not part of the wideband noise.

Table 3. Wideband Noise

V_S	WIDEBAND NOISE
3.3V	118 μ V _{RMS}
5V	123 μ V _{RMS}
\pm 5V	127 μ V _{RMS}

Aliasing

Aliasing is an inherent phenomenon of sampled data systems and occurs for input frequencies approaching the sampling frequency. The internal sampling frequency of the LTC1069-6 is 100 times its cutoff frequency. For instance, if a 98.5kHz, 100mV_{RMS} signal is applied at the input of an LTC1069-6 operating with a 50kHz clock, a 1.5kHz, 484 μ V_{RMS} alias signal will appear at the filter output. Table 4 shows details.

Table 4. Aliasing ($f_{CLK} = 50kHz$)

INPUT FREQUENCY ($V_{IN} = 1V_{RMS}$) (kHz)	OUTPUT LEVEL (Relative to Input) (dB)	OUTPUT FREQUENCY (Aliased Frequency) (kHz)
$f_{CLK}/f_C = 50:1$, $f_{CUTOFF} = 1kHz$		
96 (or 104)	-78.3	4.0
97 (or 103)	-70.4	3.0
98 (or 102)	-80.6	2.0
98.5 (or 101.5)	-46.3	1.5
99 (or 101)	-2.8	1.0
99.5 (or 100.5)	-1.38	0.5

PACKAGE DESCRIPTION

S8 Package
8-Lead Plastic Small Outline (Narrow 0.150)
 (LTC DWG # 05-08-1610)

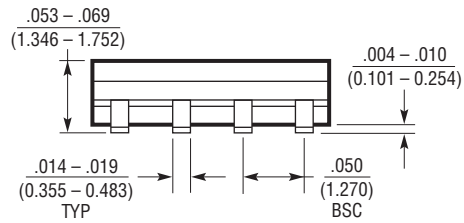
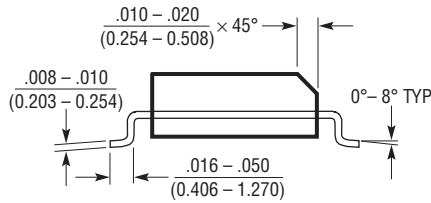
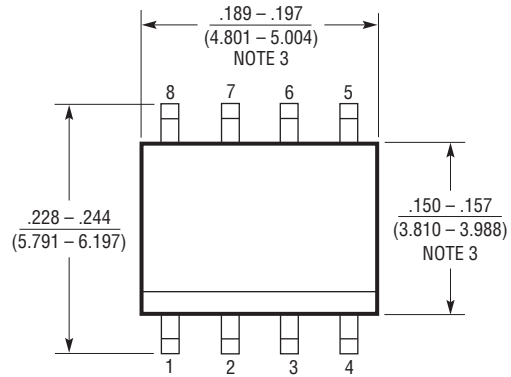
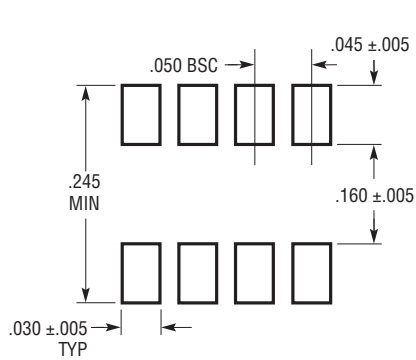

- NOTE:
 1. DIMENSIONS IN $\frac{\text{INCHES}}{\text{MILLIMETERS}}$
 2. DRAWING NOT TO SCALE
 3. THESE DIMENSIONS DO NOT INCLUDE MOLD FLASH OR PROTRUSIONS.
 MOLD FLASH OR PROTRUSIONS SHALL NOT EXCEED .006" (0.15mm)

S08 0303

TYPICAL APPLICATION

Single 5V Operation with Power Shutdown

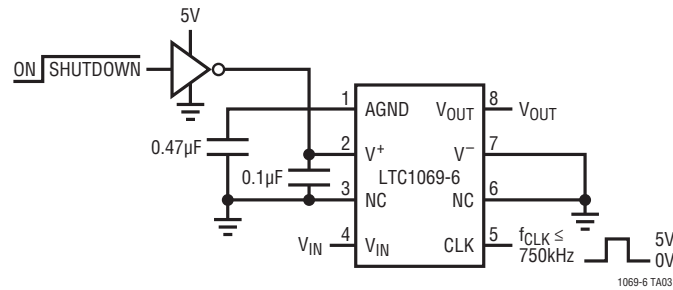

Single 3V Supply Operation with Output Buffer

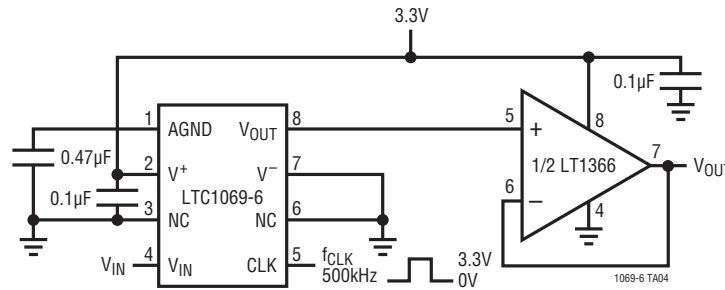

Single 3V Supply Voice Band Lowpass Filter with Rail-to-Rail Input and Output

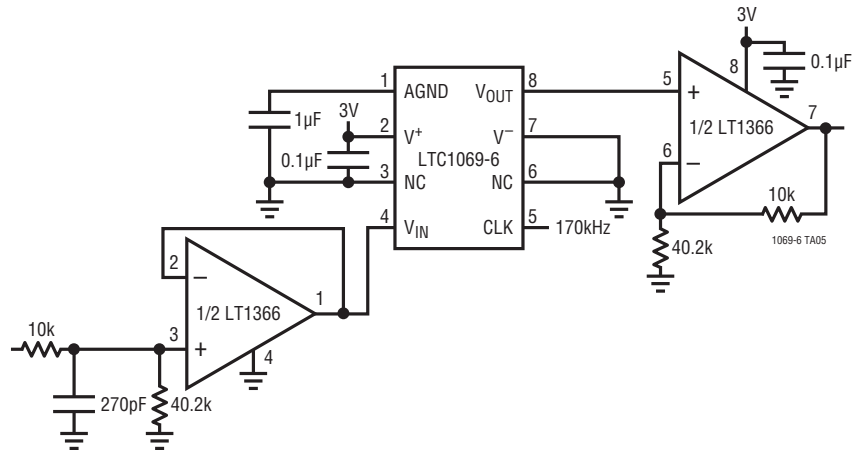

RELATED PARTS

PART NUMBER	DESCRIPTION	COMMENTS
LTC1068	Very Low Noise, High Accuracy, Quad Universal Filter Building Block	User-Configurable, SSOP Package
LTC1069-1	Low Power, Progressive Elliptic LPF	f_{CLK}/f_C Ratio 100:1, 8-Pin SO Package
LTC1164-5	Low Power 8th Order Butterworth LPF	f_{CLK}/f_C Ratio 100:1 and 50:1
LTC1164-6	Low Power 8th Order Elliptic LPF	f_{CLK}/f_C Ratio 100:1 and 50:1
LTC1164-7	Low Power 8th Order Linear Phase LPF	f_{CLK}/f_C Ratio 100:1 and 50:1

X-ON Electronics

Largest Supplier of Electrical and Electronic Components

Click to view similar products for [Active Filter](#) category:

Click to view products by [Analog Devices](#) manufacturer:

Other Similar products are found below :

[1D38810GQ2](#) [1D73312GQ22](#) [1D38830GQ3](#) [D51510GQ1](#) [D45015GQ42](#) [HMC894LP5ETR](#) [HMC896LP4ETR](#) [HMC891LP5ETR](#)
[MAX7491CEE+](#) [MAX7415CUA+](#) [MAX7413CPA+](#) [MAX7411CPA+](#) [MAX7410CPA+](#) [MAX7405EPA+](#) [MAX7413CUA+](#) [MAX7411CUA+](#)
[MAX7408CPA+](#) [MAX7405CPA+](#) [MAX7401EPA+](#) [MAX293CWE+](#) [MAX281AEWE+](#) [MAX275ACPP+](#) [MAX264BEPI+](#) [MAX263BEPI+](#)
[MAX293ESA+](#) [MAX280EPA+](#) [MAX275AEPP+](#) [MAX268BCWG+](#) [MAX263AEPI+](#) [MAX7423EUA+T](#) [LT1568CGN#PBF](#)
[LTC1062CSW#PBF](#) [LTC1562CG-2#PBF](#) [HMC881LP5ETR](#) [HMC882LP5ETR](#) [HMC1000LP5ETR](#) [LTC1569CS8-6#PBF](#) [LTC1563-](#)
[2IGN#PBF](#) [MAX7426EPA+](#) [MAX7426CPA+](#) [MAX7410EPA+](#) [MAX7407EPA+](#) [MAX7407CPA+](#) [MAX7427CPA+](#) [MAX7412CPA+](#)
[MAX7404EPA+](#) [MAX7404CPA+](#) [MAX7400EPA+](#) [MAX7400CPA+](#) [MAX296EPA+](#)