

Doubler Charge Pump with Low Noise Linear Regulator in ThinSOT

FEATURES

- Low Output Noise: 90 μ V_{RMS} (100kHz BW)
- Fixed Output Voltage: 5V
- Input Voltage Range: 2.7V to 4.4V
- No Inductors Required
- Uses Small Ceramic Capacitors
- Output Current Up to 30mA
- 550kHz Switching Frequency
- Low Operating Current: 190 μ A
- Low Shutdown Current: 4 μ A
- Internal Thermal Shutdown and Current Limiting
- Low Profile (1mm) ThinSOT™ Package

APPLICATIONS

- VCO Power Supplies for Cellular Phones
- 2-Way Pagers
- Wireless PCMCIA Cards
- Portable Medical Instruments
- Low Power Data Acquisition
- Remote Transmitters
- White LED Drivers
- GaAs Switches

DESCRIPTION

The LTC[®]1928-5 is a doubler charge pump with an internal low noise, low dropout (LDO) linear regulator. The part is designed to provide a low noise boosted supply voltage for powering noise sensitive devices such as high frequency VCOs in wireless applications.

An internal charge pump converts a 2.7V to 4.4V input to a boosted output, while the internal LDO regulator converts the boosted voltage to a low noise regulated output. The regulator is capable of supplying up to 30mA of output current. Shutdown reduces the supply current to <8 μ A, removes the load from V_{IN} by disabling the regulator and discharges V_{OUT} to ground through a 200 Ω switch.

The LTC1928-5 LDO regulator is stable with only 2 μ F on the output. Small ceramic capacitors can be used, reducing PC board area.

The LTC1928-5 is short-circuit and overtemperature protected. The part is available in a 6-pin low profile (1mm) ThinSOT package.

LT, LT, LTC, LTM, Linear Technology and the Linear logo are registered trademarks and ThinSOT and Burst Mode are trademarks of Linear Technology Corporation. All other trademarks are the property of their respective owners.

TYPICAL APPLICATION

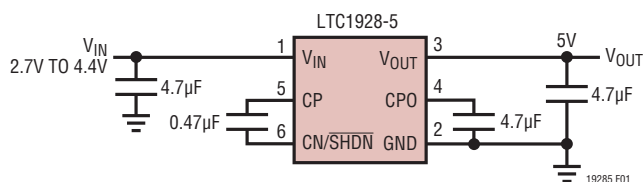
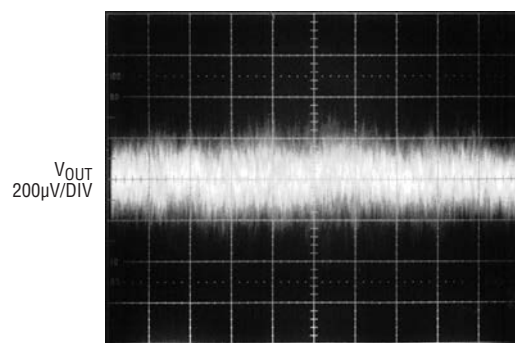

Figure 1. Low Noise 5V Power Supply

Output Noise (BW = 10Hz to 2.5MHz)



CCPO = C_{OUT} = 4.7 μ F 100 μ s/DIV
 I_{OUT} = 10mA
 V_{IN} = 3V
 V_{OUT} = 5A
 T_A = 25°C

ABSOLUTE MAXIMUM RATINGS

(Note 1)

V_{IN} to Ground	-0.3V to 5V
V_{OUT} Voltage	-0.3V to 5.25V
CPO to Ground	10V
CN/ $\overline{\text{SHDN}}$ to Ground	-0.3V to ($V_{IN} + 0.3V$)
V_{OUT} Short-Circuit Duration	Indefinite
I_{OUT}	40mA
Operating Temperature Range (Note 2)	-40°C to 85°C
Maximum Junction Temperature	125°C
Storage Temperature Range	-65°C to 150°C
Lead Temperature (Soldering, 10 sec)	300°C

PIN CONFIGURATION

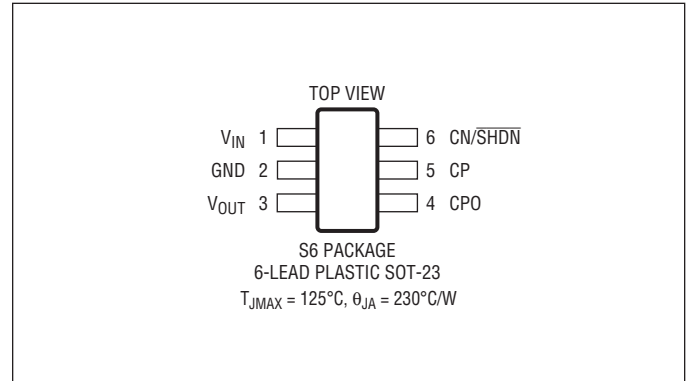

ORDER INFORMATION

LEAD FREE FINISH	TAPE AND REEL	PART MARKING	PACKAGE DESCRIPTION	TEMPERATURE RANGE
LTC1928ES6-5#PBF	LTC1928ES6-5#TRPBF	LTKT	6-Lead Plastic SOT-23	-40°C to 85°C

Consult LTC Marketing for parts specified with wider operating temperature ranges.

Consult LTC Marketing for information on nonstandard lead based finish parts.

For more information on lead free part marking, go to: <http://www.linear.com/leadfree/>

For more information on tape and reel specifications, go to: <http://www.linear.com/tapeandreel/>

ELECTRICAL CHARACTERISTICS The ● denotes the specifications which apply over the full operating temperature range, otherwise specifications are at $T_A = 25^\circ\text{C}$. $V_{IN} = 3V$, $C_{FLY} = 0.47\mu\text{F}$, C_{OUT} , C_{CPO} , $C_{IN} = 4.7\mu\text{F}$ unless otherwise specified.

PARAMETER	CONDITIONS	MIN	TYP	MAX	UNITS
V_{IN} Operating Voltage		● 2.7		4.4	V
I_{VIN} Shutdown Current	$\overline{\text{SHDN}} = 0V$ (Note 5)	●	4	8	μA
I_{VIN} Operating Current	$I_{OUT} = 0\text{mA}$, Burst Mode™ Operation	●	190	330	μA
Regulated Output Voltage	$I_{OUT} = 1\text{mA}$	● 4.9	5	5.1	V
V_{OUT} Temperature Coefficient			±50		ppm
Charge Pump Oscillator Frequency	$I_{OUT} > 500\mu\text{A}$, $V_{IN} = 2.7V$ to $4.4V$	● 480	550	620	kHz
CPO Output Resistance	$V_{IN} = 2.7V$, $I_{OUT} = 10\text{mA}$ $V_{IN} = 4.4V$, $I_{OUT} = 10\text{mA}$	●	17 14	30 24	Ω Ω
V_{OUT} Dropout Voltage (Note 3)	$I_{OUT} = 10\text{mA}$, $V_{OUT} = 5V$	●		100	mV
V_{OUT} Enable Time	$R_{LOAD} = 2k$		0.6		ms
V_{OUT} Output Noise Voltage	$I_{OUT} = 10\text{mA}$, $10\text{Hz} \leq f \leq 100\text{kHz}$ $I_{OUT} = 10\text{mA}$, $10\text{Hz} \leq f \leq 2.5\text{MHz}$		90 800		μV_{RMS} $\mu\text{V}_{\text{P-P}}$
V_{OUT} Line Regulation	$V_{IN} = 2.7V$ to $4.4V$, $I_{OUT} = 0$	●	4	20	mV
V_{OUT} Load Regulation	$I_{OUT} = 1\text{mA}$ to 10mA $I_{OUT} = 1\text{mA}$ to 30mA (Note 4)	●	2 4	10	mV mV
V_{OUT} Shutdown Resistance	CN/ $\overline{\text{SHDN}} = 0V$ (Note 5) $V_{IN} = 2.7V$, Resistance Measured to Ground $V_{IN} = 4.4V$, Resistance Measured to Ground	● ●	160 100	400 300	Ω Ω

ELECTRICAL CHARACTERISTICS The ● denotes the specifications which apply over the full operating temperature range, otherwise specifications are at $T_A = 25^\circ\text{C}$. $V_{IN} = 3\text{V}$, $C_{FLY} = 0.47\mu\text{F}$, C_{OUT} , C_{CPO} , $C_{IN} = 4.7\mu\text{F}$ unless otherwise specified.

CN/SHDN Input Threshold	$V_{IN} = 2.7\text{V}$ to 4.4V (Note 5)	●	0.15	0.5	1.6	V
CN/SHDN Input Current	CN/SHDN = 0V (Note 5)	●	-1	-3	-6	μA

Note 1: Stresses beyond those listed under Absolute Maximum Ratings may cause permanent damage to the device. Exposure to any Absolute Maximum Rating condition for extended periods may affect device reliability and lifetime.

Note 2: The LTC1928ES6-5 is guaranteed to meet performance specifications from 0°C to 70°C . Specifications over the -40°C to 85°C

operating temperature range are assured by design, characterization and correlation with statistical process controls.

Note 3: Dropout voltage is the minimum input/output voltage required to maintain regulation at the specified output current. In dropout the output voltage will be equal to: $V_{CPO} - V_{DROPOUT}$ (see Figure 2).

TYPICAL PERFORMANCE CHARACTERISTICS

CPO Output Resistance vs V_{IN}

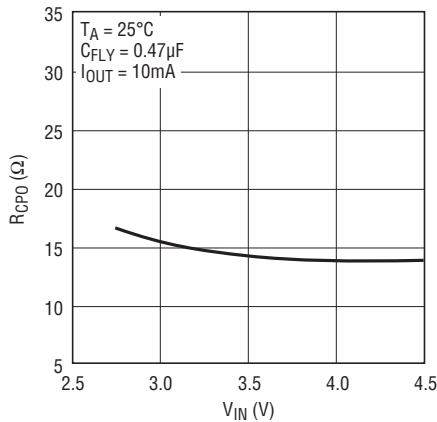

19285 G01

Min and Max V_{CPO} vs V_{IN}

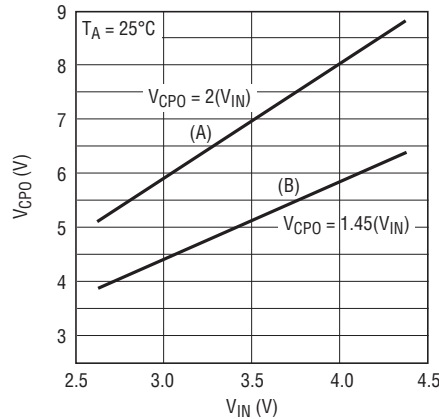

- (A) THE MAXIMUM GENERATED NO LOAD CPO VOLTAGE
- (B) THE MINIMUM ALLOWABLE CPO VOLTAGE, AT FULL LOAD, TO ENSURE THAT THE LDO IS NOT DISABLED

19285 G02

V_{OUT} Transient Response

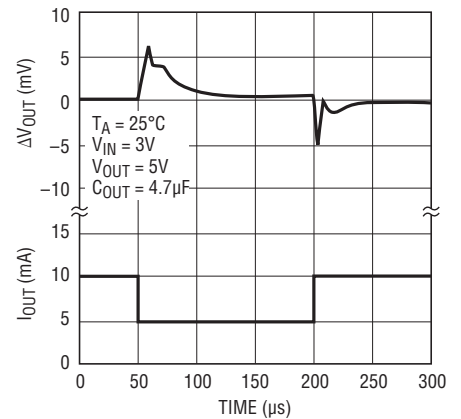

19285 G03

Shutdown to Enable Timing (Figure 5)

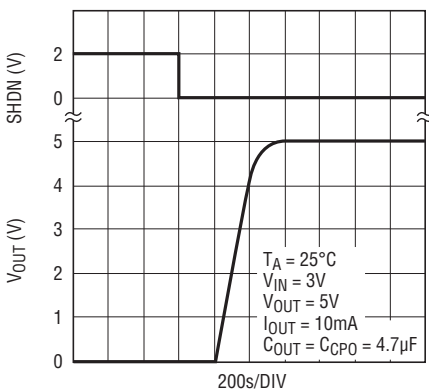

19285 G04

Enable to Shutdown Timing (Figure 5)

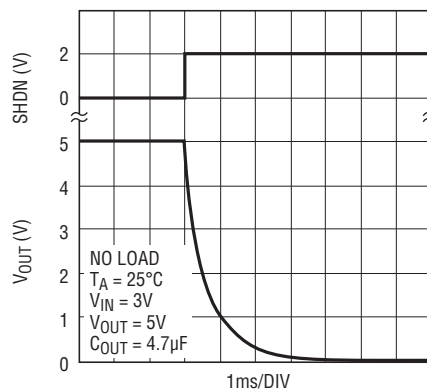

19285 G05

V_{OUT} Voltage vs Temperature

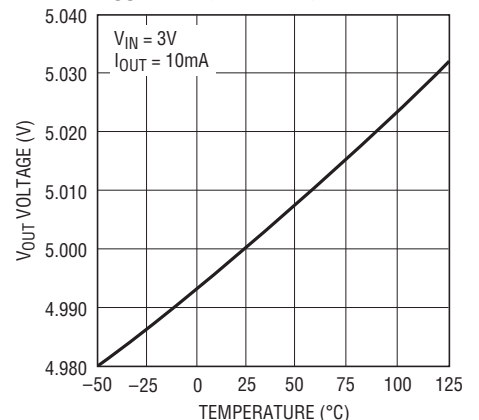

19285 G06

19285fa

TYPICAL PERFORMANCE CHARACTERISTICS

Operating Current vs V_{IN}
(No Load)

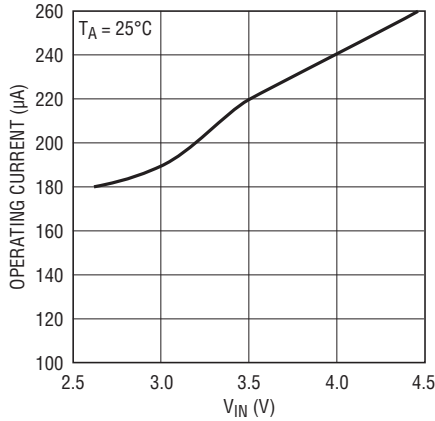

19285 G07

Efficiency vs Supply Voltage

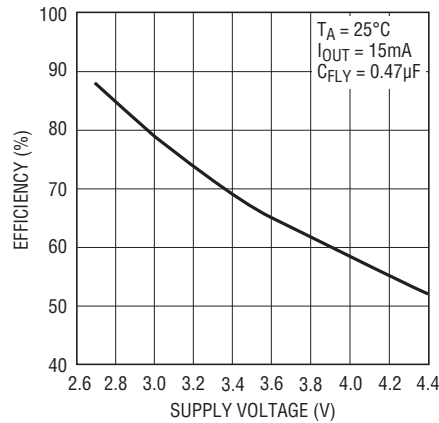

19285 G08

Output Voltage vs Output Current

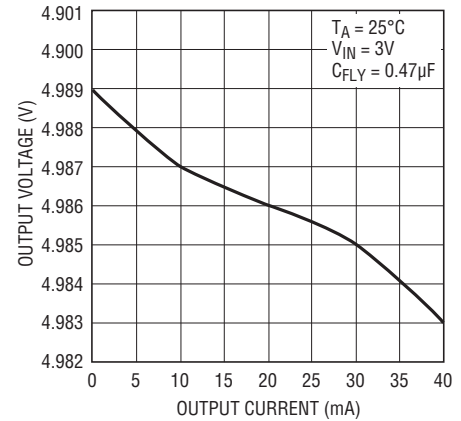

19285 G09

PIN FUNCTIONS

V_{IN} (Pin 1): Input Voltage, 2.7V to 4.4V. V_{IN} should be bypassed with a $\geq 2\mu F$ low ESR capacitor as close to the pin as possible for best performance. A minimum capacitance value of 0.1 μF is required.

GND (Pin 2): System Ground.

V_{OUT} (Pin 3): Low Noise Regulated Output Voltage. V_{OUT} should be bypassed with a $\geq 2\mu F$ low ESR capacitor as close to the pin as possible for best performance. The V_{OUT} voltage is internally set to 5V.

CPO (Pin 4): Boosted Unregulated Voltage. Approximately $1.95V_{IN}$ at low loads. Bypass with a $\geq 2\mu F$ low ESR capacitor.

CP (Pin 5): Flying Capacitor Positive Input.

CN/ \overline{SHDN} (Pin 6): Flying Capacitor Negative Input and \overline{SHDN} . When this pin is pulled to ground through a 100Ω resistor, the part will go into shutdown within approximately 30 μs .

BLOCK DIAGRAM

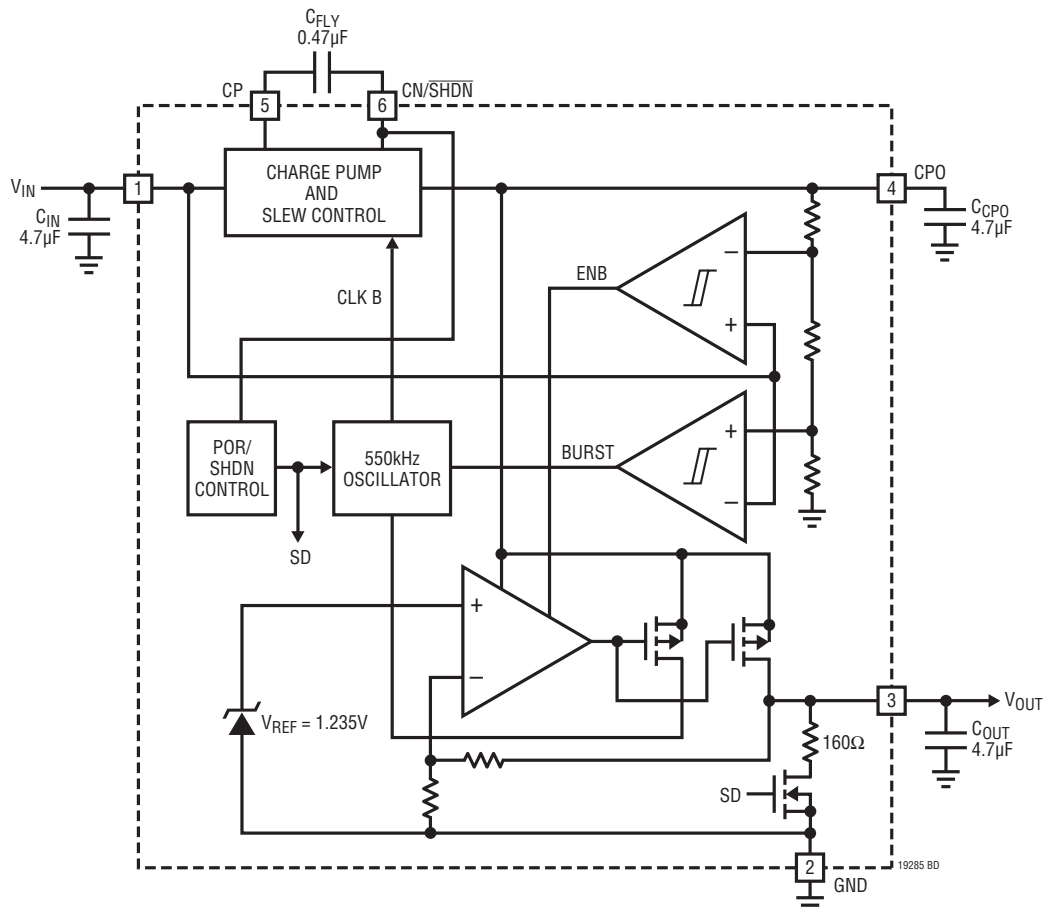

APPLICATIONS INFORMATION

Operation

The LTC1928-5 uses a switched-capacitor charge pump to generate a CPO voltage of approximately $2V_{IN}$. CPO powers an internal low dropout linear regulator that supplies a regulated output at V_{OUT} . Internal comparators are used to sense CPO and V_{IN} voltages for power-up conditioning. The output current is sensed to determine the charge pump operating mode. A trimmed internal bandgap is used as the voltage reference and a trimmed internal oscillator is used to control the charge pump switches.

The charge pump is a doubler configuration that uses one external flying capacitor. When enabled, a 2-phase nonoverlapping clock controls the charge pump switches. At start-up, the LDO is disabled and the load is removed from CPO. When CPO reaches $1.75V_{IN}$ the LDO is enabled. If CPO falls below $1.45V_{IN}$ the LDO will be disabled. Gen-

erally, the charge pump runs open loop with continuous clocking for low noise. If CPO is greater than $1.95V_{IN}$ and I_{OUT} is less than $200\mu A$, the charge pump will operate in Burst Mode operation for increased efficiency but slightly higher output noise. In Burst Mode operation, the clock is disabled when CPO reaches $1.95V_{IN}$ and enabled when CPO droops by about 150mV. The switching frequency is precisely controlled to ensure that the frequency is above 455kHz and at the optimum rate to ensure maximum efficiency. The switch edge rates are also controlled to minimize noise. The effective output resistance at CPO is dependent on the voltage at V_{IN} , CPO, the flying capacitor value C_{FLY} and the junction temperature. A low ESR capacitor of $\geq 2\mu F$ should be used at CPO for minimum noise.

The LDO is used to filter the ripple on CPO and to set an output voltage independent of CPO. V_{OUT} is set by an in-

APPLICATIONS INFORMATION

ternal reference and resistor divider. The LDO requires a capacitor on V_{OUT} for stability and improved load transient response. A low ESR capacitor of $\geq 2\mu\text{F}$ should be used.

Maximum I_{OUT} Calculations

The maximum available current can be calculated based on the open circuit CPO voltage, the dropout voltage of the LDO and the effective output resistance of the charge pump. The open circuit CPO voltage is approximately $2V_{IN}$ (see Figure 2).

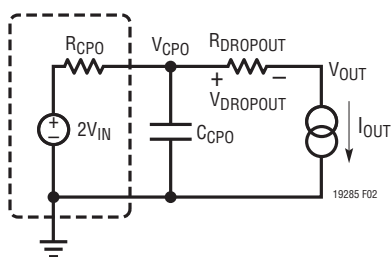

Figure 2. Equivalent Circuit

Example:

$$V_{IN} = 3\text{V}$$

$$V_{OUT} = 5\text{V}$$

$$R_{CPO} = 30\Omega$$

$$\text{Maximum unloaded CPO voltage} = 2V_{IN} = 6\text{V}$$

$$V_{DROPOUT(MAX)} = 100\text{mV}$$

$$I_{OUT(MAX)} = (2V_{IN} - V_{DROPOUT(MAX)} - V_{OUT})/R_{CPO}$$

$$= (6\text{V} - 0.1\text{V} - 5\text{V})/30\Omega = 30\text{mA}$$

V_{CPO} must be greater than $1.45V_{IN} = 4.35\text{V}$. To confirm this, calculate V_{CPO} :

$$V_{CPO} = 6\text{V} - (30\text{mA} \cdot 30\Omega) = 5.1\text{V}$$

For minimum noise applications the LDO must be kept out of dropout to prevent CPO noise from coupling into V_{OUT} .

External CPO Loading

The CPO output can drive an external load (for example, an LDO). The current required by this additional load will reduce the available current from V_{OUT} . If the external load requires 1mA, the available current at V_{OUT} will be reduced by 1mA.

Short-Circuit and Thermal Protection

V_{OUT} can be shorted to ground indefinitely. Internal circuitry will limit the output current. If the junction temperature

exceeds 150°C the part will shut down. Excessive power dissipation due to heavy loads will also cause the part to shut down when the junction temperature exceeds 150°C . The part will become enabled when the junction temperature drops below 140°C . If the fault conditions remain in place, the part will cycle between the shutdown and enabled states.

Capacitor Selection

For best performance it is recommended that low ESR ceramic capacitors be used to reduce noise and ripple. C_{OUT} must be $\geq 2\mu\text{F}$ and C_{CPO} must be equal to or greater than C_{OUT} . C_{IN} is dependent on the input power supply source impedance. The charge pump demands large instantaneous currents which may induce ripple onto a common voltage rail. C_{IN} should be $\geq 2\mu\text{F}$ and a spike reducing resistor of 2.2Ω may be required between V_{IN} and the supply.

A low ESR ceramic capacitor is recommended for the flying capacitor C_{FLY} with a value of $0.47\mu\text{F}$. At low load or high V_{IN} a smaller capacitor could be used to reduce ripple on CPO which would reflect as lower ripple on V_{OUT} .

If a minimum enable time is required, the CPO output filter capacitor should be at least $2\times$ the V_{OUT} filter capacitor. When the LDO is first enabled, the CPO capacitor will dump a large amount of charge into the V_{OUT} capacitor. If the drop in the CPO voltage falls below $1.45V_{IN}$ the LDO will be disabled and the CPO voltage will be required to charge up to $1.75V_{IN}$ to enable the LDO. The resulting cycling extends the enable time.

Output Ripple

The output ripple on CPO includes a spike component from the charge pump switches and a droop component which is dependent on the load current and the value of C_3 . The charge pump has been carefully designed to minimize the spike component, however, low ESR capacitors are essential to reduce the remaining spike energy effect on the CPO voltage. C_{CPO} should be increased for high load currents to minimize the droop component. Ripple components on CPO are greatly reduced at V_{OUT} by the LDO, however, C_{OUT} should also be a low ESR capacitor to improve filtering of the CPO noise.

APPLICATIONS INFORMATION

Shutdown

When $\overline{\text{CN/SHDN}} = 0\text{V}$, the part will be in shutdown, the supply current will be $<8\mu\text{A}$ and V_{OUT} will be shorted to ground through a 160Ω switch. In addition, CPO will be high impedance and disconnected from V_{IN} and $\overline{\text{CN/SHDN}}$.

Shutdown is achieved by internally sampling the $\overline{\text{CN/SHDN}}$ pin for a low voltage. Time between shutdown samples is about $30\mu\text{s}$. During the sample time the charge pump switches are disabled and $\overline{\text{CN/SHDN}}$ must be pulled to ground within 400ns . A resistor value between 100Ω and 1k is recommended. Parasitic lead capacitance should be minimized on the $\overline{\text{CN/SHDN}}$ pin.

Power-On Reset

Upon initial power-up, a power-on reset circuit ensures that the internal functions are correctly initialized. Once V_{IN} reaches about 1V , the power-on reset circuit will enable the part as long as the $\overline{\text{CN/SHDN}}$ pin is not pulled low.

Thermal Considerations

The power handling capability of the device will be limited by the maximum rated junction temperature (125°C). The device dissipation $P_{\text{D}} = I_{\text{OUT}}(2V_{\text{IN}} - V_{\text{OUT}}) + V_{\text{IN}}(2\text{mA})$. The

device dissipates the majority of its heat through its pins, especially GND (Pin 2). Thermal resistance to ambient can be optimized by connecting GND to a large copper region on the PCB, which serves as a heat sink. Applications that operate the LTC1928-5 near maximum power levels should maximize the copper area at all pins except CP and $\overline{\text{CN/SHDN}}$ and ensure that there is some airflow over the part to carry away excess heat.

General Layout Considerations

Due to the high switching frequency and high transient currents produced by the device, careful board layout is a must. A clean board layout using a ground plane and short connections to all capacitors will improve noise performance and ensure proper regulation.

Measuring Output Noise

Measuring the LTC1928 low noise levels requires care. Figure 3 shows a test setup for taking the measurement. Good connection and signal handling technique should yield about $800\mu\text{V}_{\text{P-P}}$ over a 2.5MHz bandwidth. The noise measurement involves AC-coupling the LTC1928 output into the test setup's input and terminating this connection with 50Ω . Coaxial connections must be maintained to preserve measurement integrity.

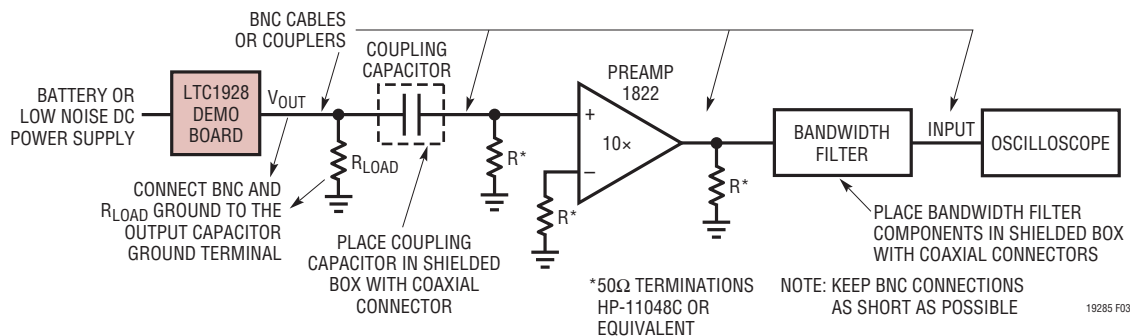

Figure 3. LTC1928-5 Noise Measurement Test Setup

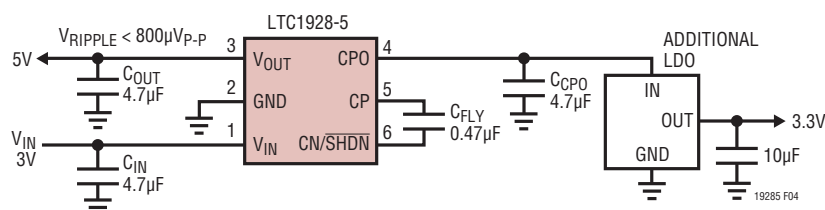
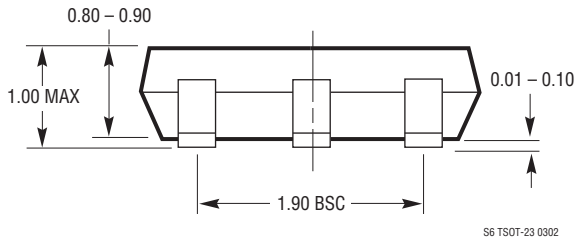
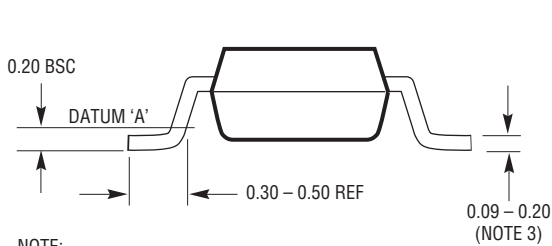
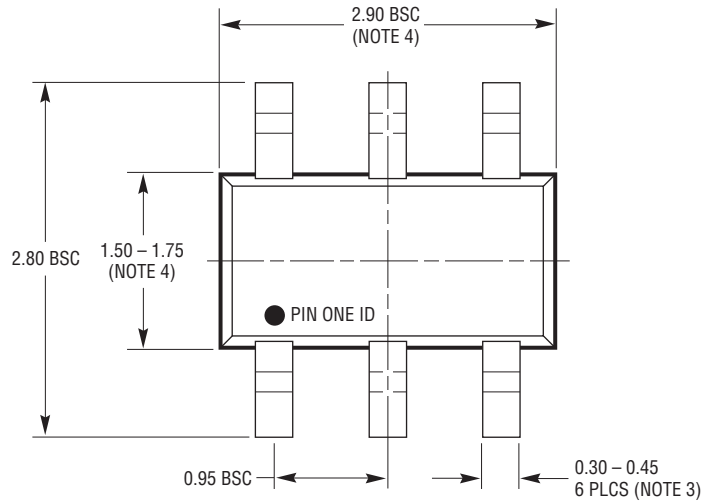
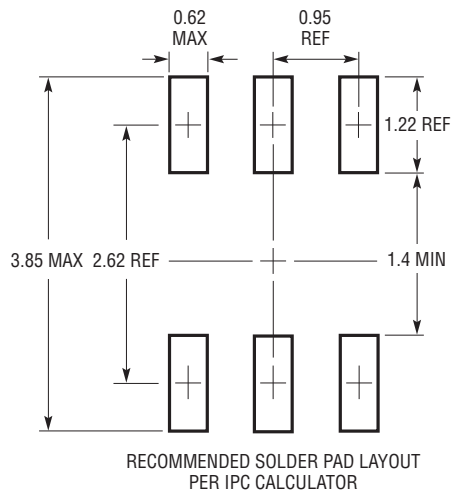

Figure 4. LTC1928-5, External Load on CPO, No Shutdown State

PACKAGE DESCRIPTION

Please refer to <http://www.linear.com/designtools/packaging/> for the most recent package drawings.

S6 Package 6-Lead Plastic TSOT-23 (Reference LTC DWG # 05-08-1636)



- NOTE:
1. DIMENSIONS ARE IN MILLIMETERS
 2. DRAWING NOT TO SCALE
 3. DIMENSIONS ARE INCLUSIVE OF PLATING
 4. DIMENSIONS ARE EXCLUSIVE OF MOLD FLASH AND METAL BURR
 5. MOLD FLASH SHALL NOT EXCEED 0.254mm
 6. JEDEC PACKAGE REFERENCE IS MO-193

S6 TSOT-23 0302

REVISION HISTORY

REV	DATE	DESCRIPTION	PAGE NUMBER
A	09/15	Revised package drawing.	8

TYPICAL APPLICATION

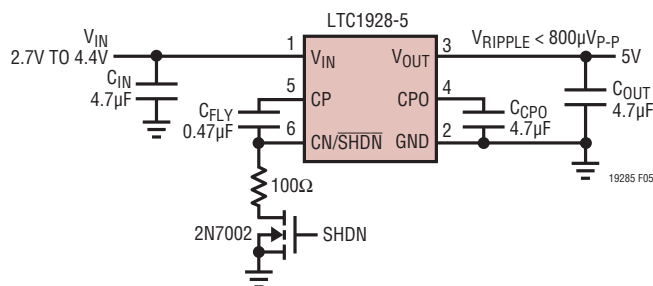

Figure 5. Low Noise 5V Supply with Shutdown

RELATED PARTS

PART NUMBER	DESCRIPTION	COMMENTS
LTC1550/LTC1551	Low Noise, 900kHz Charge Pump	1mV _{P-P} Typical Ripple, Up to 10mA
LT1611	Inverting 1.4MHz Switching Regulator	5V to -5V at 150mA, Low Output Noise
LT1613	1.4MHz Boost Switching Regulator in ThinSOT	3.3V to 5V at 200mA, Low Noise PWM Operation
LTC1682	Doubler Charge Pump with Low Noise Linear Regulator	60µV _{RMS} Noise, I _{OUT} Up to 80mA, MSOP
LTC1754-5	Micropower 5V Charge Pump in ThinSOT	I _Q = 13µA, I _{OUT} to 50mA, Shutdown
LT1761 Series	100mA ThinSOT, Low Noise LDO Regulators	20µA I _Q , 20µV _{RMS} Noise, 300mV Dropout
LTC3200	Constant Frequency Doubler Charge Pump	Low Noise, 5V Output or Adjustable

X-ON Electronics

Largest Supplier of Electrical and Electronic Components

Click to view similar products for [Switching Voltage Regulators](#) category:

Click to view products by [Analog Devices](#) manufacturer:

Other Similar products are found below :

[FAN53610AUC33X](#) [FAN53611AUC123X](#) [FAN48610BUC33X](#) [FAN48610BUC45X](#) [FAN48617UC50X](#) [R3](#) [430464BB](#) [KE177614](#)
[FAN53611AUC12X](#) [MAX809TTR](#) [NCV891234MW50R2G](#) [NCP81103MNTXG](#) [NCP81203PMNTXG](#) [NCP81208MNTXG](#)
[NCP81109GMNTXG](#) [SCY1751FCCT1G](#) [NCP81109JMNTXG](#) [AP3409ADNTR-G1](#) [NCP81241MNTXG](#) [LTM8064IY](#) [LT8315EFE#TRPBF](#)
[LTM4664EY#PBF](#) [LTM4668AIY#PBF](#) [NCV1077CSTBT3G](#) [XCL207A123CR-G](#) [MPM54304GMN-0002](#) [MPM54304GMN-0004](#)
[MPM54304GMN-0003](#) [AP62300Z6-7](#) [MP8757GL-P](#) [MIC23356YFT-TR](#) [LD8116CGL](#) [HG2269M/TR](#) [OB2269](#) [XD3526](#) [U6215A](#) [U6215B](#)
[U6620S](#) [LTC3412IFE](#) [LT1425IS](#) [MAX25203BATJA/VY+](#) [MAX77874CEWM+](#) [XC9236D08CER-G](#) [MP3416GJ-P](#) [BD9S201NUX-CE2](#)
[MP5461GC-Z](#) [MPQ4415AGQB-Z](#) [MPQ4590GS-Z](#) [MAX38640BENT18+T](#) [MAX77511AEWB+](#)