

## FEATURES

- **98dBFS SFDR**
- **80dBFS SNR Noise Floor**
- **Aperture Jitter = 45fs<sub>RMS</sub>**
- PGA Front-End 2.4V<sub>P-P</sub> or 1.6V<sub>P-P</sub> Input Range
- Optional Internal Dither
- Optional Data Output Randomizer
- Power Dissipation: 1280mW
- Shutdown Mode
- Serial SPI Port for Configuration
- Clock Duty Cycle Stabilizer
- 48-Lead (7mm × 7mm) QFN Package

## APPLICATIONS

- Software Defined Radios
- Military Radio and RADAR
- Cellular Base Stations
- Spectral Analysis
- Imaging Systems
- ATE and Instrumentation

## DESCRIPTION

The **LTC®2107** is a 16-bit, 210Msps high performance ADC. The combination of high sample rate, low noise and high linearity enable a new generation of digital radio designs. The direct sampling front-end is designed specifically for the most demanding receiver applications such as software defined radio and multi-channel GSM base stations. The AC performance includes, SNR = 80dBFS, SFDR = 98dBFS. Aperture jitter = 45fs<sub>RMS</sub> allows direct sampling of IF frequencies up to 500MHz with excellent performance.

Features such as internal dither, a PGA front-end and digital output randomization help maximize performance. Modes of operation can be controlled through a 3-wire serial interface (SPI).

The double data rate (DDR) low voltage differential (LVDS) digital outputs help reduce digital line count and enable space saving designs.

LT, LT, LTC, LTM, Linear Technology and the Linear logo are registered trademarks of Linear Technology Corporation. All other trademarks are the property of their respective owners. Protected by U.S. Patents, including 7683695, 8482442, 8648741.

## BLOCK DIAGRAM

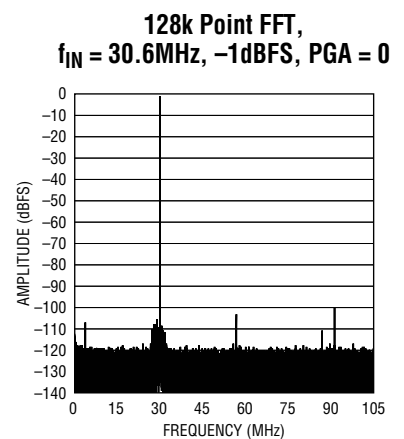
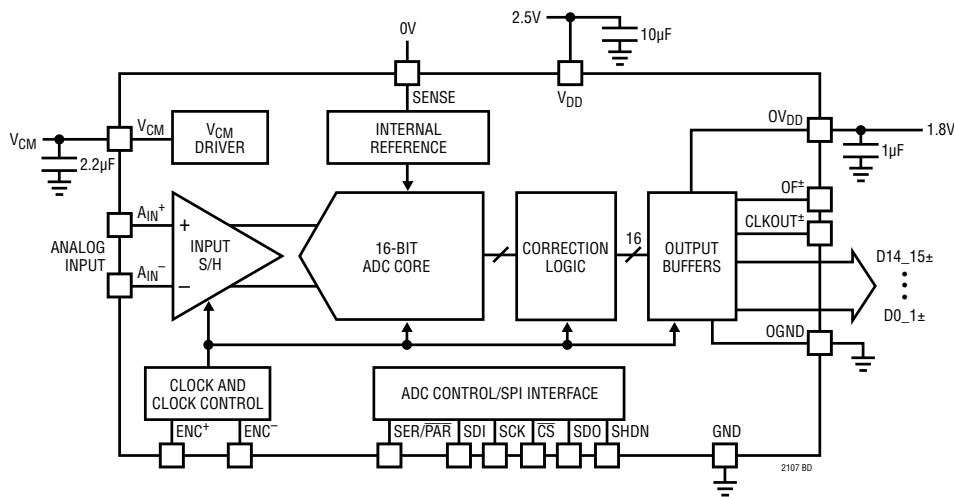

# LTC2107

## ABSOLUTE MAXIMUM RATINGS (Notes 1, 2)

Supply Voltage	Digital Output Voltage .....	-0.3V to (OV <sub>DD</sub> + 0.3V)
V <sub>DD</sub> .....	SDO (Note 4) .....	-0.3V to 3.9V
OV <sub>DD</sub> .....	Operating Temperature Range	
Analog Input Voltage	LTC2107C .....	0°C to 70°C
A <sub>IN</sub> <sup>+</sup> , A <sub>IN</sub> <sup>-</sup> , ENC <sup>+</sup> , ENC <sup>-</sup> , PAR/SER, SENSE	LTC2107I .....	-40°C to 85°C
(Note 3) .....	Storage Temperature Range .....	-65°C to 150°C
Digital Input Voltage		
CS, SDI, SCK (Note 4) .....		

## PIN CONFIGURATION

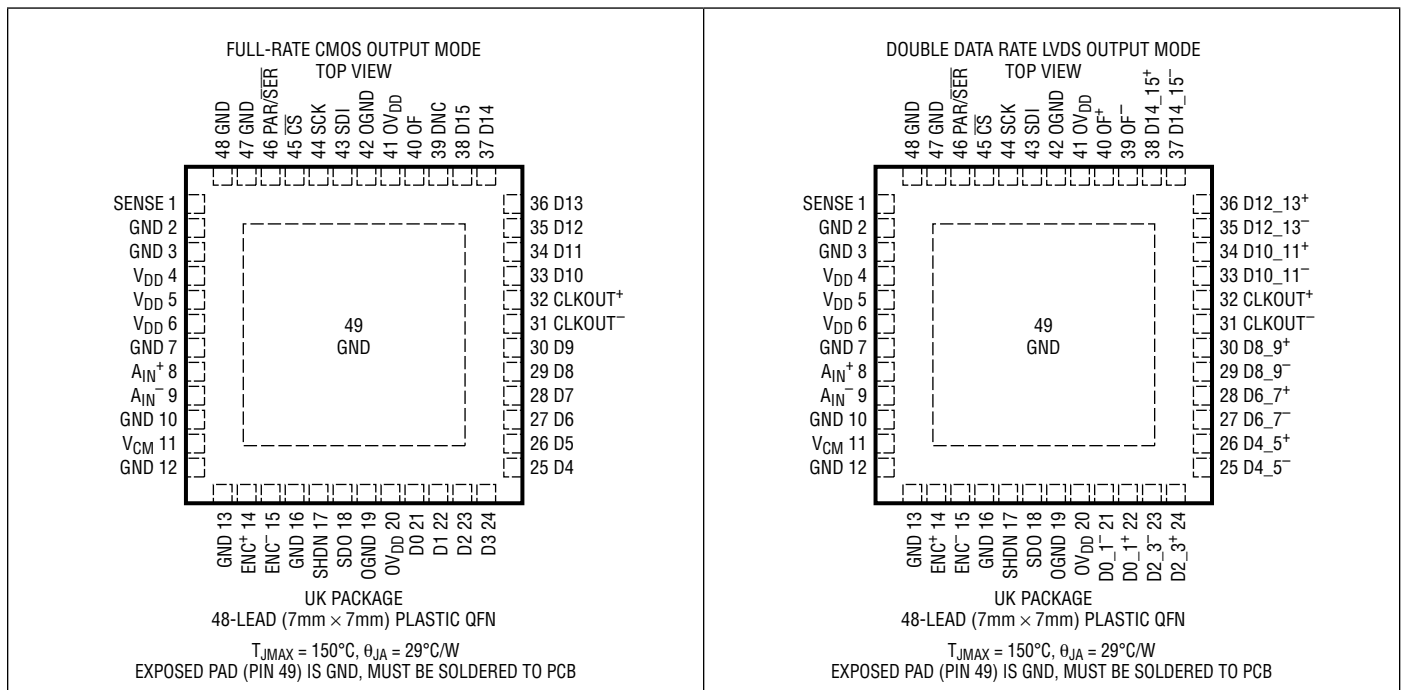

## ORDER INFORMATION

LEAD FREE FINISH	TAPE AND REEL	PART MARKING*	PACKAGE DESCRIPTION	TEMPERATURE RANGE
LTC2107CUK#PBF	LTC2107CUK#TRPBF	LTC2107UK	48-Lead (7mm × 7mm) Plastic QFN	0°C to 70°C
LTC2107IUK#PBF	LTC2107IUK#TRPBF	LTC2107UK	48-Lead (7mm × 7mm) Plastic QFN	-40°C to 85°C

Consult LTC Marketing for parts specified with wider operating temperature ranges. \*The temperature grade is identified by a label on the shipping container.

For more information on lead free part marking, go to: <http://www.linear.com/leadfree/>

For more information on tape and reel specifications, go to: <http://www.linear.com/tapeandree/>. Some packages are available in 500 unit reels through designated sales channels with #TRMPBF suffix.

## CONVERTER CHARACTERISTICS

The ● denotes the specifications which apply over the full operating temperature range, otherwise specifications are at  $T_A = 25^\circ\text{C}$ . (Note 5)

PARAMETER	CONDITIONS	MIN	TYP	MAX	UNITS		
Resolution (No Missing Codes)		●	16		Bits		
Integral Linearity Error	Differential Analog Input (Note 6)	●	-4.5	±1.6	4.5	LSB	
Differential Linearity Error	Differential Analog Input		-1	±0.4	1.0	LSB	
Offset Error	(Note 7)	●	-5	-0.5	5	mV	
Gain Error	Internal Reference, PGA = 0 External Reference, PGA = 0	●		±1.5	-0.2	0.85	%FS %FS
Offset Drift			-20			$\mu\text{V}/^\circ\text{C}$	
Full-Scale Drift	Internal Reference, PGA = 0 External Reference, PGA = 0			110 70		ppm/ $^\circ\text{C}$ ppm/ $^\circ\text{C}$	
Transition Noise	External Reference, PGA = 0 External Reference, PGA = 1			2.3 3.0		LSB <sub>RMS</sub> LSB <sub>RMS</sub>	
Noise Density, Input Referred	PGA = 0, Sample Rate = 210Msps, Bandwidth = 105MHz PGA = 1, Sample Rate = 210Msps, Bandwidth = 105MHz			8.3 7.2		nV/ $\sqrt{\text{Hz}}$ nV/ $\sqrt{\text{Hz}}$	

## ANALOG INPUT

The ● denotes the specifications which apply over the full operating temperature range, otherwise specifications are at  $T_A = 25^\circ\text{C}$ . (Note 5)

SYMBOL	PARAMETER	CONDITIONS	MIN	TYP	MAX	UNITS	
$V_{IN}$	Analog Input Range ( $A_{IN^+} - A_{IN^-}$ )	2.375V < $V_{DD}$ < 2.625V, PGA = 0 2.375V < $V_{DD}$ < 2.625V, PGA = 1	● ●	2.4 1.6		$V_{P-P}$ $V_{P-P}$	
$V_{IN(CM)}$	Analog Input Common Mode ( $A_{IN^+} + A_{IN^-}$ )/2	Differential Analog Input (Note 8)	●	1.15	$V_{CM}$	1.25	V
$V_{SENSE}$	External Voltage Reference Applied to SENSE	External Reference Mode	●	1.225	1.250	1.275	V
$I_{IN1}$	Analog Input Leakage Current	0.6V < $A_{IN^+}$ < 1.8V, 0.6V < $A_{IN^-}$ < 1.8V	●	-1		1	$\mu\text{A}$
$I_{IN2}$	SENSE, PAR/SER Input Leakage Current	0 < SENSE, PAR/SER < $V_{DD}$	●	-1		1	$\mu\text{A}$
$t_{AP}$	Sample-and-Hold Acquisition Delay Time	$R_S = 25\Omega$		0.5			ns
$t_{JITTER}$	Sample-and-Hold Acquisition Delay Jitter	(Note 11)		45			fs <sub>RMS</sub>
BW-3dB	Full-Power Bandwidth	$R_S = 25\Omega$		800			MHz
	Over-Range Recovery Time	±120% Full Scale (Note 10)		1			Cycles

## DYNAMIC ACCURACY

The ● denotes the specifications which apply over the full operating temperature range, otherwise specifications are at  $T_A = 25^\circ\text{C}$ .  $A_{IN} = -1\text{dBFS}$ . (Note 5)

SYMBOL	PARAMETER	CONDITIONS	MIN	TYP	MAX	UNITS
SNR	Signal-to-Noise Ratio	5.1MHz Input (PGA = 0) 30.3MHz Input (PGA = 0) 71.1MHz Input (PGA = 0) 141MHz Input (PGA = 0)	●	78	79.8 79.7 79.5 79.1	dBFS dBFS dBFS dBFS
		141MHz Input (PGA = 1) 250MHz Input (PGA = 0) 250MHz Input (PGA = 1)	●	75.2	77.0 78.2 76.4	dBFS dBFS dBFS
SFDR	Spurious Free Dynamic Range 2nd Harmonic	5.1MHz Input (PGA = 0) 30.3MHz Input (PGA = 0) 71.1MHz Input (PGA = 0) 141MHz Input (PGA = 0)	●	84	104.3 96.8 87 87.5	dBFS dBFS dBFS dBFS
		141MHz Input (PGA = 1) 250MHz Input (PGA = 0) 250MHz Input (PGA = 1)	●	84	95.5 85.8 89.3	dBFS dBFS dBFS
	Spurious Free Dynamic Range 3rd Harmonic	5.1MHz Input (PGA = 0) 30.3MHz Input (PGA = 0) 71.1MHz Input (PGA = 0) 141MHz Input (PGA = 0)	●	86	98 96.8 87 93.3	dBFS dBFS dBFS dBFS
		141MHz Input (PGA = 1) 250MHz Input (PGA = 0) 250MHz Input (PGA = 1)	●	86	100 80.4 83.5	dBFS dBFS dBFS
	Spurious Free Dynamic Range 4th Harmonic or Higher	5.1MHz Input (PGA = 0) 30.3MHz Input (PGA = 0) 71.1MHz Input (PGA = 0) 141MHz Input (PGA = 0)	●	93	100.8 101.6 100.7 105	dBFS dBFS dBFS dBFS
		141MHz Input (PGA = 1) 250MHz Input (PGA = 0) 250MHz Input (PGA = 1)	●	91	96.4 95.7 96.3	dBFS dBFS dBFS
S/(N+D)	Signal-to-Noise Plus Distortion Ratio	5.1MHz Input (PGA = 0) 30.3MHz Input (PGA = 0) 71.1MHz Input (PGA = 0) 141MHz Input (PGA = 0)	●	77	79.4 79.5 78.4 78.7	dBFS dBFS dBFS dBFS
		141MHz Input (PGA = 1) 250MHz Input (PGA = 0) 250MHz Input (PGA = 1)	●	74	76.7 76.7 76.0	dBFS dBFS dBFS
SFDR	Spurious Free Dynamic Range at -25dBFS Dither "Off"	5.1MHz Input (PGA = 0) 30.3MHz Input (PGA = 0) 71.1MHz Input (PGA = 0) 141MHz Input (PGA = 0)	●	95	100.4 107.4 106.6 108.3	dBFS dBFS dBFS dBFS
		141MHz Input (PGA = 1) 250MHz Input (PGA = 0) 250MHz Input (PGA = 1)			106.7 106.7 106.7	dBFS dBFS dBFS
	Spurious Free Dynamic Range at -25dBFS Dither "On"	5.1MHz Input (PGA = 0) 30.3MHz Input (PGA = 0) 71.1MHz Input (PGA = 0) 141MHz Input (PGA = 0)	●	103	126 124 119 119	dBFS dBFS dBFS dBFS
		141MHz Input (PGA = 1) 250MHz Input (PGA = 0) 250MHz Input (PGA = 1)			122.3 124.4 124.6	dBFS dBFS dBFS
SNRD	SNR Density	Sample Rate = 210Msps, PGA = 0 Sample Rate = 210Msps, PGA = 1		160.2 157.9	dBFS/ $\sqrt{\text{Hz}}$ dBFS/ $\sqrt{\text{Hz}}$	

## **V<sub>CM</sub> OUTPUT** The ● denotes the specifications which apply over the full operating temperature range, otherwise specifications are at T<sub>A</sub> = 25°C. (Note 5)

PARAMETER	CONDITIONS	MIN	TYP	MAX	UNITS
V <sub>CM</sub> Output Voltage	I <sub>OUT</sub> = 0	1.17	1.20	1.23	V
V <sub>CM</sub> Output Temperature Drift			18		ppm/°C
V <sub>CM</sub> Output Resistance	-1mA < I <sub>OUT</sub> < 1mA		0.35		Ω
V <sub>CM</sub> Line Regulation	2.375V < V <sub>DD</sub> < 2.625V		0.8		mV/V

## **DIGITAL INPUTS AND OUTPUTS** The ● denotes the specifications which apply over the full operating temperature range, otherwise specifications are at T<sub>A</sub> = 25°C. (Note 5)

SYMBOL	PARAMETER	CONDITIONS	MIN	TYP	MAX	UNITS	
<b>Encode Inputs (ENC<sup>+</sup>, ENC<sup>-</sup>)</b>							
V <sub>ID</sub>	Differential Input Voltage	(Note 8)	●	0.2	2	V	
V <sub>ICM</sub>	Common Mode Input Voltage	Internally Set Externally Set (Note 8)		1.1	1.2 1.5	V V	
V <sub>IN</sub>	Input Voltage Range	ENC <sup>+</sup> , ENC <sup>-</sup> to GND	●	0	2.5	V	
R <sub>IN</sub>	Input Resistance	(See Figure 8)		5		kΩ	
R <sub>TERM</sub>	Optional Encode Termination	Encode Termination Enabled (See Figure 8)		107		Ω	
C <sub>IN</sub>	Input Capacitance	Between ENC <sup>+</sup> and ENC <sup>-</sup> (Note 8)		3		pF	
<b>Digital Inputs (CS, SDI, SCK, SHDN)</b>							
V <sub>IH</sub>	High Level Input Voltage	V <sub>DD</sub> = 2.5V	●	1.2		V	
V <sub>IL</sub>	Low Level Input Voltage	V <sub>DD</sub> = 2.5V	●		0.6	V	
I <sub>IN</sub>	Input Current	V <sub>IN</sub> = 0V to 3.6V	●	-10	10	μA	
C <sub>IN</sub>	Input Capacitance	(Note 8)		2		pF	
<b>SDO Output (Open-Drain Output. Requires 2kΩ Pull-Up Resistor if SDO Is Used)</b>							
R <sub>OL</sub>	Logic Low Output Resistance to GND	V <sub>DD</sub> = 2.5V, SDO = 0V		260		Ω	
I <sub>OH</sub>	Logic High Output Leakage Current	SDO = 0V to 3.6V	●	-10	10	μA	
C <sub>OUT</sub>	Output Capacitance	(Note 8)		2		pF	
<b>Digital Data Outputs (CMOS Mode)</b>							
V <sub>OH</sub>	High Level Output Voltage	I <sub>O</sub> = -500μA	●	1.7	1.790	V	
V <sub>OL</sub>	Low Level Output Voltage	I <sub>O</sub> = 500μA	●		0.010 0.050	V	
<b>Digital Data Outputs (LVDS Mode)</b>							
V <sub>OD</sub>	Differential Output Voltage	100Ω Differential Load, 3.5mA Mode 100Ω Differential Load, 1.75mA Mode	● ●	247 125	350 175	454 250	mV mV
V <sub>OS</sub>	Common Mode Output Voltage	100Ω Differential Load, 3.5mA Mode 100Ω Differential Load, 1.75mA Mode	● ●	1.19 1.20	1.250 1.250	1.375 1.375	V V
R <sub>TERM</sub>	On-Chip Termination Resistance	Termination Enabled, 0V <sub>DD</sub> = 1.8V, 3.5mA Mode		100			Ω

## POWER REQUIREMENTS

The ● denotes the specifications which apply over the full operating temperature range, otherwise specifications are at  $T_A = 25^\circ\text{C}$ . (Note 9)

SYMBOL	PARAMETER	CONDITIONS	MIN	TYP	MAX	UNITS
$V_{DD}$	Analog Supply Voltage	(Note 9)	● 2.375	2.5	2.625	V
$OV_{DD}$	Output Supply Voltage	CMOS Mode (Note 9)	● 1.7	1.8	1.9	V
		LVDS Mode (Note 9)	● 1.7	1.8	1.9	V
$I_{VDD}$	Analog Supply Current			495.3	545	mA
$I_{OVDD}$	Digital Supply Current	CMOS Mode		61		mA
		LVDS Mode, 1.75mA Mode	● 23.2	26		mA
		LVDS Mode, 3.5mA Mode	● 45	50		mA
$P_{DISS}$	Power Dissipation	CMOS Mode		1348		mW
		LVDS Mode, 1.75mA Mode	● 1280	1409		mW
		LVDS Mode, 3.5mA Mode	● 1320	1453		mW
$P_{SHDN}$	SHDN Mode Power			6.4		mW
$I_{VDD}$	Analog Supply Current with Inactive Encode	Encode Clock Not Active Keep Alive Oscillator Enabled		366		mA

## TIMING CHARACTERISTICS

The ● denotes the specifications which apply over the full operating temperature range, otherwise specifications are at  $T_A = 25^\circ\text{C}$ . (Note 5)

SYMBOL	PARAMETER	CONDITIONS	MIN	TYP	MAX	UNITS
$f_S$	Sampling Frequency	(Note 9)	● 10		210	MHz
$t_L$	ENC Low Time	Duty Cycle Stabilizer Off (Note 8)	● 2.26	2.38	50	ns
		Duty Cycle Stabilizer On (Note 8)	● 1.16	2.38	50	ns
$t_H$	ENC High Time	Duty Cycle Stabilizer Off (Note 8)	● 2.26	2.38	50	ns
		Duty Cycle Stabilizer On (Note 8)	● 1.16	2.38	50	ns
$t_{AP}$	Sample-and-Hold Acquisition Delay Time	$R_S = 25\Omega$		0.5		ns

### Digital Data Outputs (CMOS Mode)

$t_D$	ENC to Data Delay	$C_L = 6.8\text{pF}$ (Notes 8, 12)	● 1.3	1.9	2.5	ns
$t_C$	ENC to CLKOUT Delay	$C_L = 6.8\text{pF}$ (Notes 8, 12)	● 1.3	1.9	2.5	ns
$t_{SKEW}$	DATA to CLKOUT Skew	$t_D - t_C$ (Note 8)	● -0.3	0	0.3	ns
	Pipeline Latency			7		Cycles

### Digital Data Outputs (LVDS Mode)

$t_D$	ENC to Data Delay	$C_L = 6.8\text{pF}$ (Notes 8, 12)	● 1.3	1.9	2.5	ns
$t_C$	ENC to CLKOUT Delay	$C_L = 6.8\text{pF}$ (Notes 8, 12)	● 1.3	1.9	2.5	ns
$t_{SKEW}$	DATA to CLKOUT Skew	$t_D - t_C$ (Note 8)	● -0.3	0	0.3	ns
	Pipeline Latency			7		Cycles

### SPI Port Timing (Note 8)

$t_{SCK}$	SCK Period	Write Mode	● 40			ns
		Read Back Mode, $C_{SDO} = 20\text{pF}$ , $R_{PULLUP} = 2\text{k}$	● 250			ns
$t_{CSS}$	$\overline{CS}$ Falling to SCK Rising Setup Time		● 5			ns
$t_{SCH}$	SCK Rising to $\overline{CS}$ Rising Hold Time		● 5			ns
$t_{SCS}$	SCK Falling to $\overline{CS}$ Falling Setup Time		● 5			ns
$t_{DS}$	SDI to SCK Rising Setup Time		● 5			ns
$t_{DH}$	SCK Rising to SDI Hold Time		● 5			ns
$t_{DO}$	SCK Falling to SDO Valid	Read Back Mode, $C_{SDO} = 20\text{pF}$ , $R_{PULLUP} = 2\text{k}$	●		125	ns

## ELECTRICAL CHARACTERISTICS

**Note 1:** Stresses beyond those listed under Absolute Maximum Ratings may cause permanent damage to the device. Exposure to any Absolute Maximum Rating condition for extended periods may affect device reliability and lifetime.

**Note 2:** All voltage values are with respect to GND and OGND shorted (unless otherwise noted).

**Note 3:** When these pin voltages are taken below GND or above  $V_{DD}$ , they will be clamped by internal diodes. This product can handle input currents of greater than 100mA below GND or above  $V_{DD}$  without latchup.

**Note 4:** When these pin voltages are taken below GND they will be clamped by internal diodes. When these pin voltages are taken above  $V_{DD}$  they will not be clamped by internal diodes. This product can handle input currents of greater than 100mA below GND without latchup.

**Note 5:**  $V_{DD} = 2.5V$ ,  $OV_{DD} = 1.8V$ ,  $f_{SAMPLE} = 210MHz$ , LVDS outputs, differential  $ENC^+/ENC^- = 2V_{P-P}$  sine wave, input range =  $2.4V_{P-P}$  (PGA = 0) with differential drive, unless otherwise noted.

**Note 6:** Integral nonlinearity is defined as the deviation of a code from a best fit straight line to the transfer curve. The deviation is measured from the center of the quantization band.

**Note 7:** Offset error is the offset voltage measured from  $-0.5LSB$  when the output code flickers between 0000 0000 0000 0000 and 1111 1111 1111 1111 in 2's complement output mode.

**Note 8:** Guaranteed by design, not subject to test.

**Note 9:** Recommended operating conditions.

**Note 10:** Refer to Overflow Bit section for additional information.

**Note 11:** The test circuit of Figure 11 is used to verify jitter performance.

**Note 12:**  $C_L$  is the external single-ended load capacitance between each output pin and ground.

## TIMING DIAGRAMS

**CMOS Output Timing Mode**  
All Outputs Are Single-Ended and Have CMOS Levels

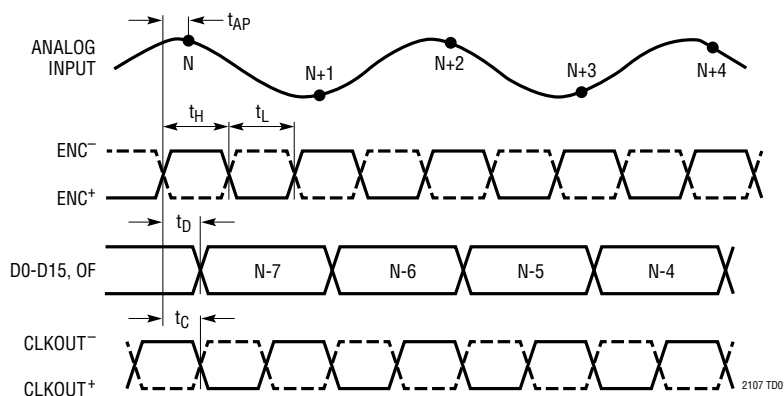

# TIMING DIAGRAMS

**Double Data Rate LVDS Output Mode Timing**  
 All Outputs Are Differential and Have LVDS Levels

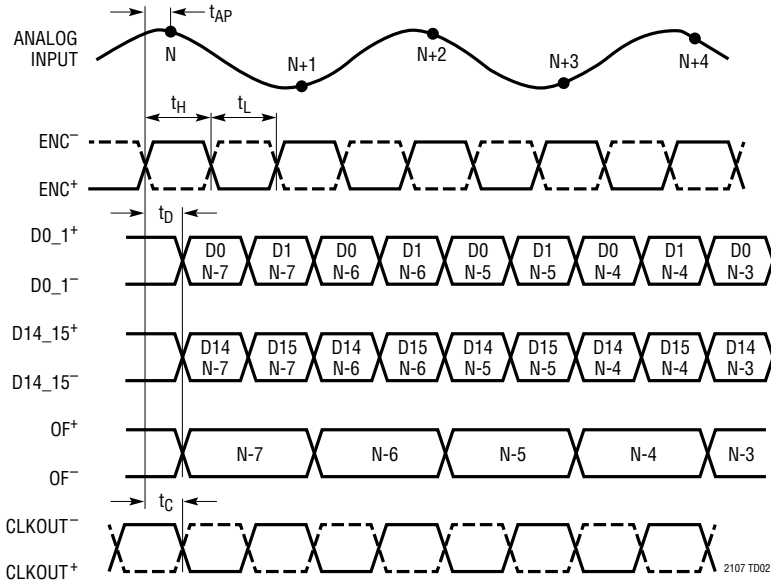

**SPI Timing (Write Mode)**

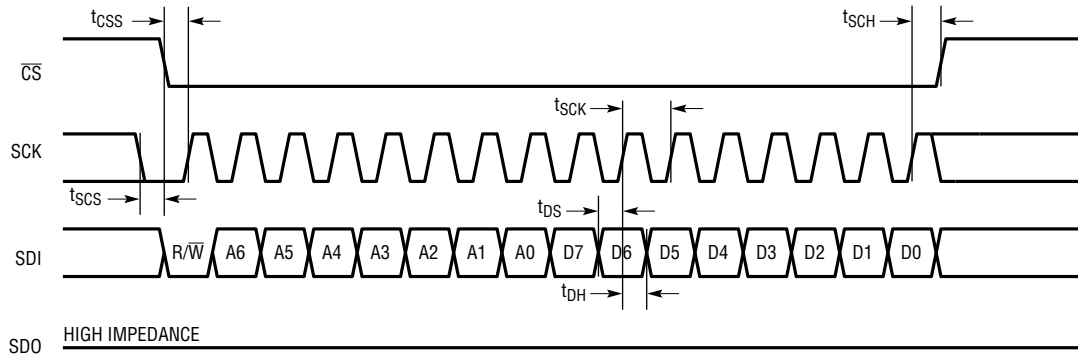

**SPI Timing (Read-Back Mode)**

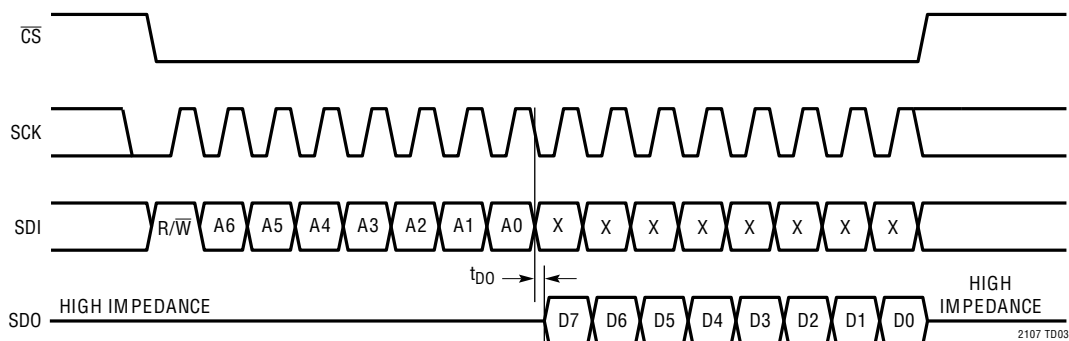



# TYPICAL PERFORMANCE CHARACTERISTICS

**Integral Nonlinearity (INL) vs Output Code**

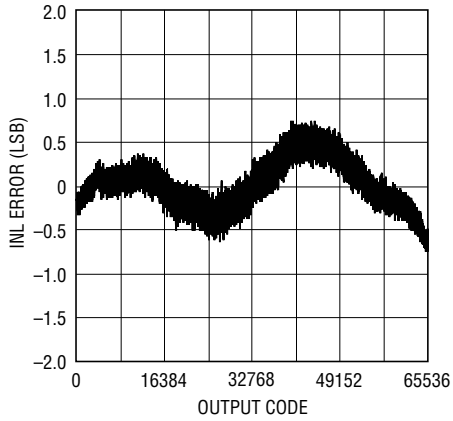

2107 G01

**Differential Nonlinearity (DNL) vs Output Code**

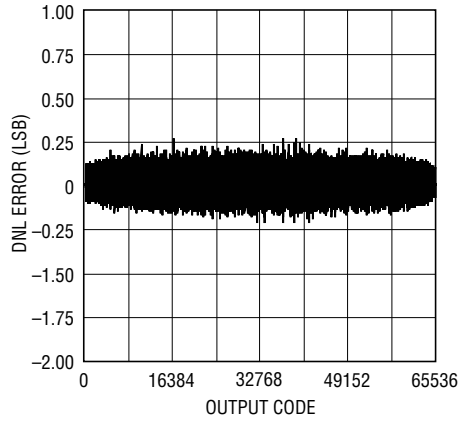

2107 G02

**AC Grounded Input Histogram**

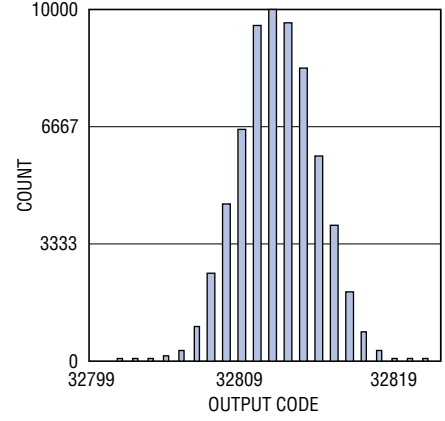

2107 G03

**128k Point FFT,  $f_{IN} = 5.0\text{MHz}$ , -1dBFS, PGA = 0, Dither On**

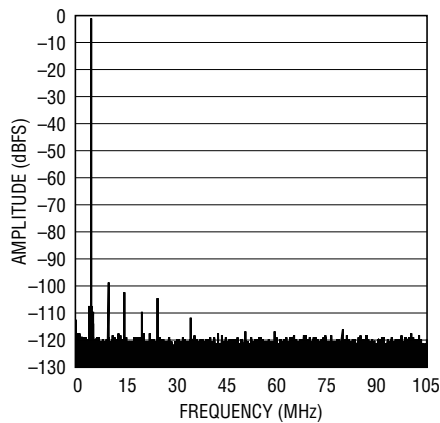

2107 G04

**128k Point FFT,  $f_{IN} = 30.6\text{MHz}$ , -1dBFS, PGA = 0, Dither On**

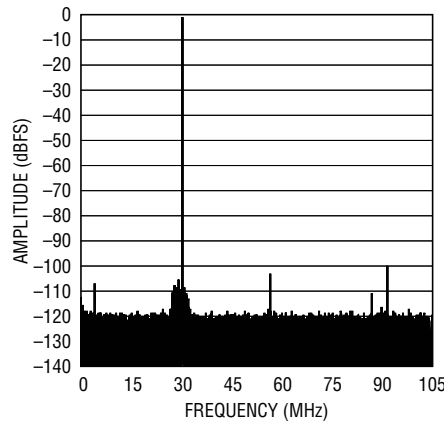

2107 G05

**128k Point FFT, 30.6MHz, -20dBFS, PGA = 0, Dither Off**

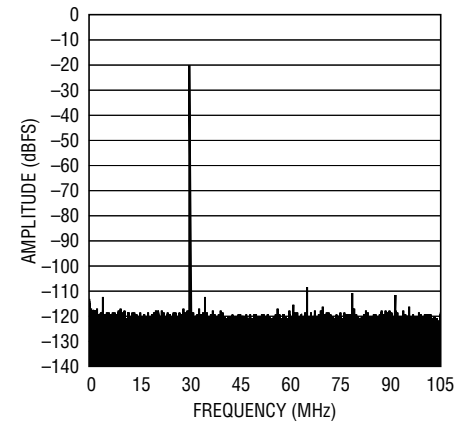

2107 G06

**128k Point FFT, 30.6MHz, -20dBFS, PGA = 0, Dither On**

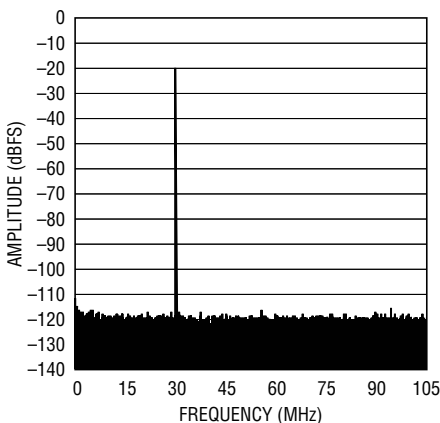

2107 G07

**128k Point 2-Tone FFT, 25.1MHz and 30.51MHz, -7dBFS PGA = 0, Dither On**

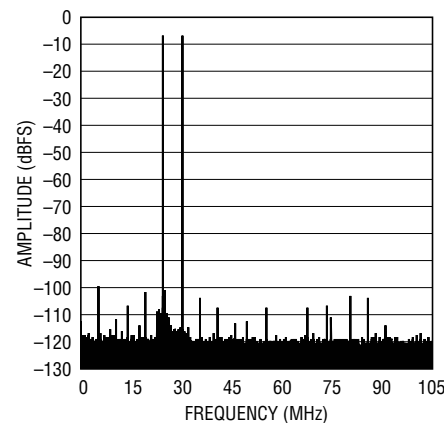

2107 G08

**128k Point 2-Tone FFT, 25.07MHz and 30.5MHz, -20dBFS PGA = 0, Dither On**

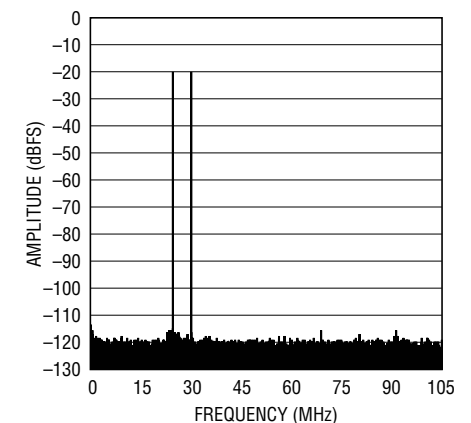

2107 G09

2107fb

**TYPICAL PERFORMANCE CHARACTERISTICS**

**SFDR vs Input Level,  $f_{IN} = 30.6\text{MHz}$ ,  
PGA = 0, Dither Off**

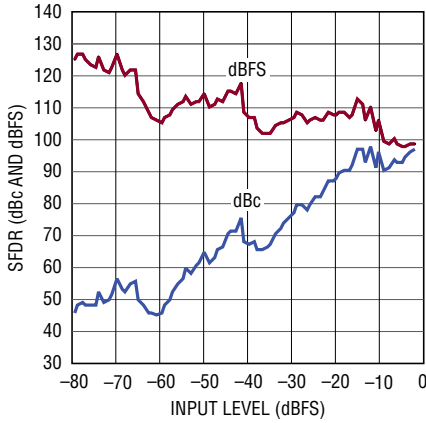

2107 G10

**SFDR vs Input Level,  $f_{IN} = 30.6\text{MHz}$ ,  
PGA = 0, Dither On**

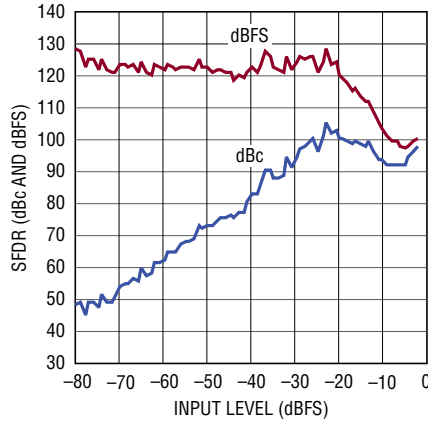

2107 G11

**128k Point FFT,  $f_{IN} = 71.1\text{MHz}$ ,  
-1dBFS, PGA = 0, Dither On**

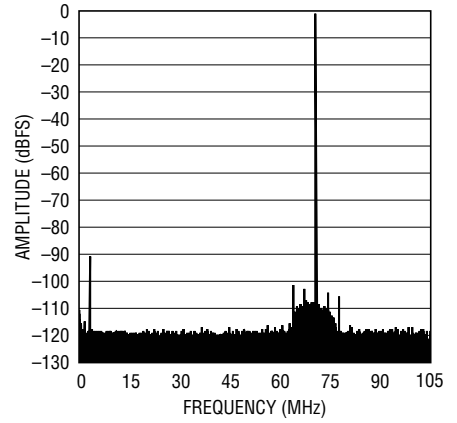

2107 G12

**128k Point FFT,  $f_{IN} = 71.1\text{MHz}$ ,  
-10dBFS, PGA = 0, Dither On**

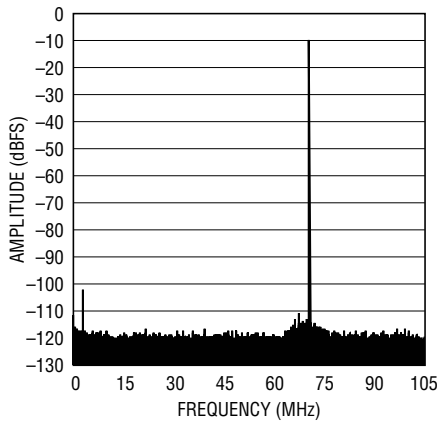

2107 G13

**128k Point FFT,  $f_{IN} = 71.1\text{MHz}$ ,  
-20dBFS, PGA = 0, Dither On**

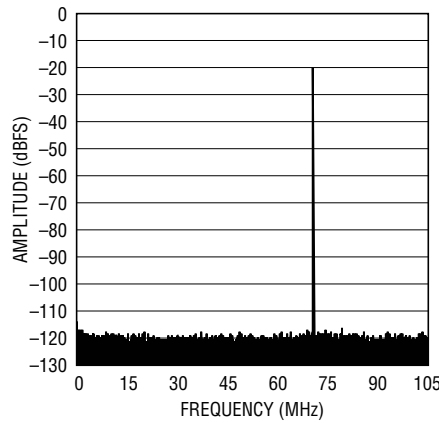

2107 G14

**128k Point FFT,  $f_{IN} = 71.1\text{MHz}$ ,  
-20dBFS, PGA = 1, Dither On**

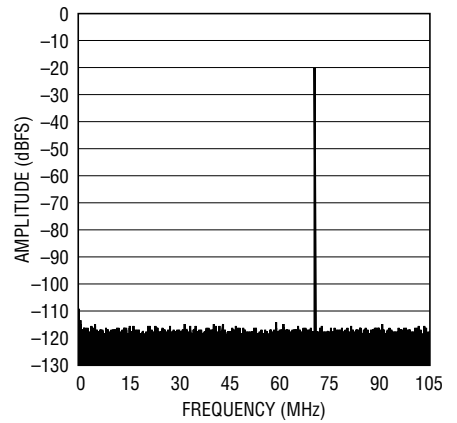

2107 G15

**SFDR vs Input Level,  $f_{IN} = 71.1\text{MHz}$ ,  
PGA = 1, Dither Off**

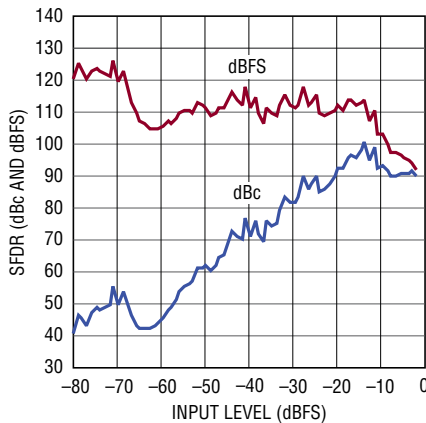

2107 G16

**SFDR vs Input Level,  $f_{IN} = 71.1\text{MHz}$ ,  
PGA = 1, Dither On**

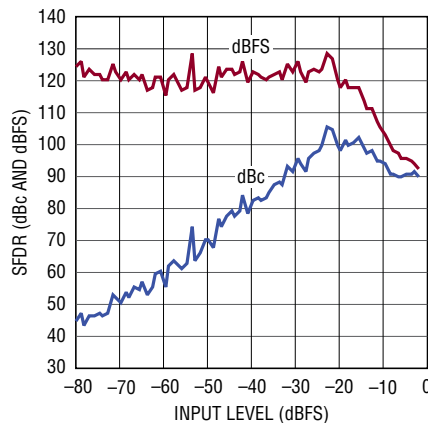

2107 G17

**128k Point FFT,  $f_{IN} = 71.1\text{MHz}$   
and 80MHz, -7dBFS, PGA = 0,  
Dither On**

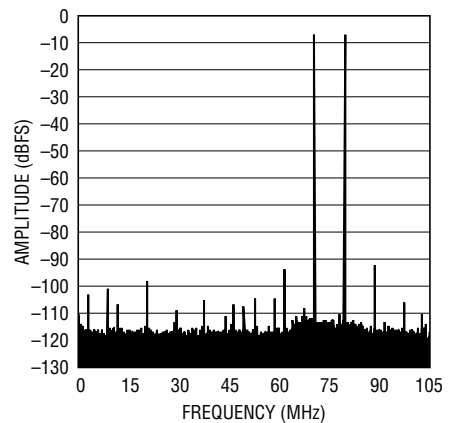

2107 G18

2107fb

# TYPICAL PERFORMANCE CHARACTERISTICS

128k Point FFT,  $f_{IN} = 71.1\text{MHz}$   
and 80MHz, -15dBFS, PGA = 0,  
Dither On

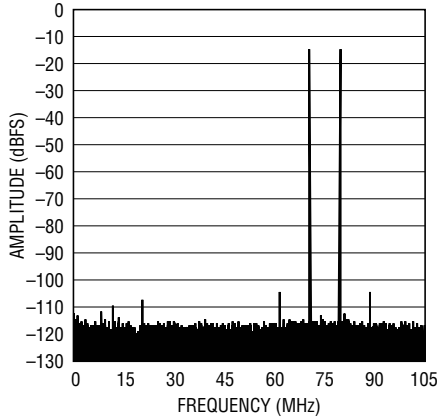

2107 G19

64k Point FFT,  $f_{IN} = 141.1\text{MHz}$ ,  
-1dBFS, PGA = 0, Dither On

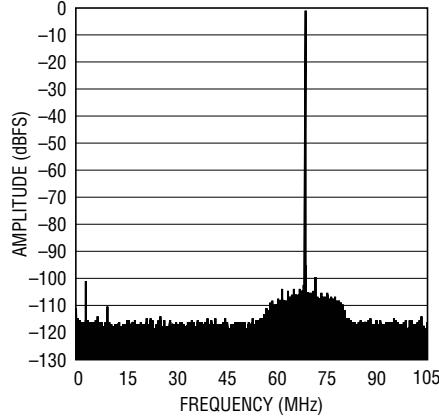

2107 G20

64k Point FFT,  $f_{IN} = 141.1\text{MHz}$ ,  
-1dBFS, PGA = 1, Dither On

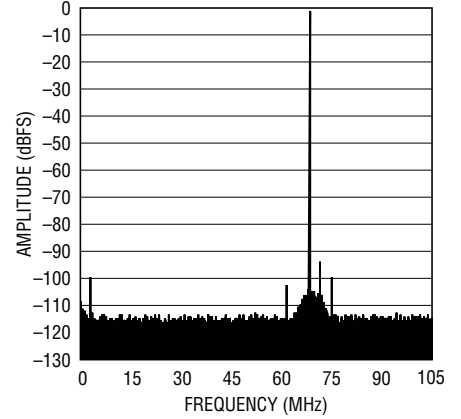

2107 G21

SFDR vs Input Level,  $f_{IN} = 141.1\text{MHz}$ ,  
PGA = 1, Dither Off

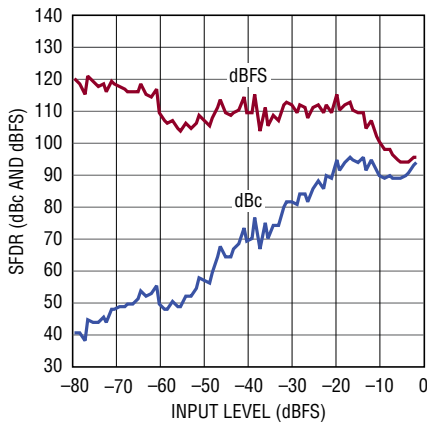

2107 G22

SFDR vs Input Level,  $f_{IN} = 141.1\text{MHz}$ ,  
PGA = 1, Dither On

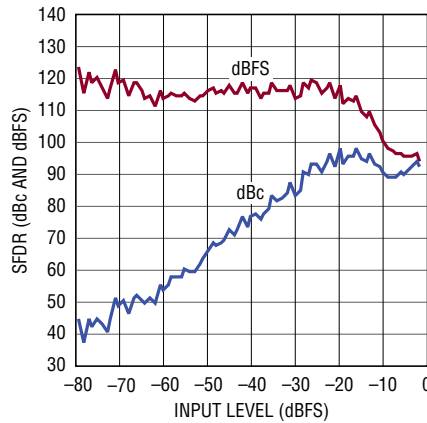

2107 G23

64k Point FFT,  $f_{IN} = 170.0\text{MHz}$ ,  
-1dBFS, PGA = 1, Dither On

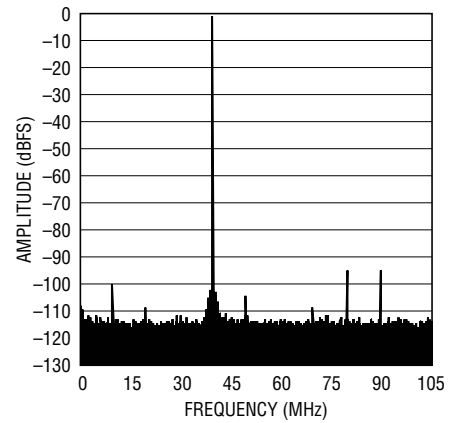

2107 G24

128k Point FFT,  $f_{IN} = 250.0\text{MHz}$ ,  
-1dBFS, PGA = 1, Dither On

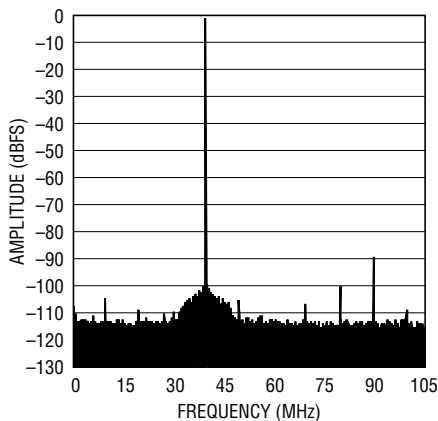

2107 G25

128k Point FFT,  $f_{IN} = 250.0\text{MHz}$ ,  
-10dBFS, PGA = 1, Dither On

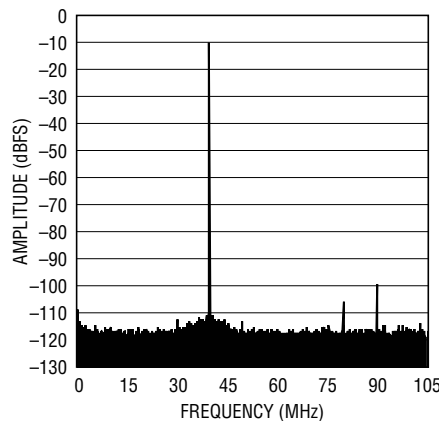

2107 G26

128k Point FFT,  $f_{IN} = 380.0\text{MHz}$ ,  
-1dBFS, PGA = 1, Dither On

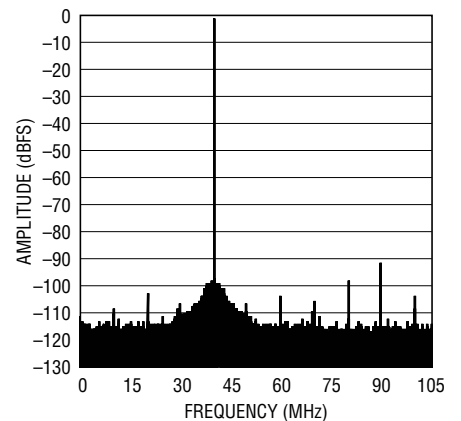

2107 G27

TYPICAL PERFORMANCE CHARACTERISTICS

128k Point FFT,  $f_{IN} = 380.0\text{MHz}$ ,  $-10\text{dBFS}$ ,  $\text{PGA} = 1$ , Dither On

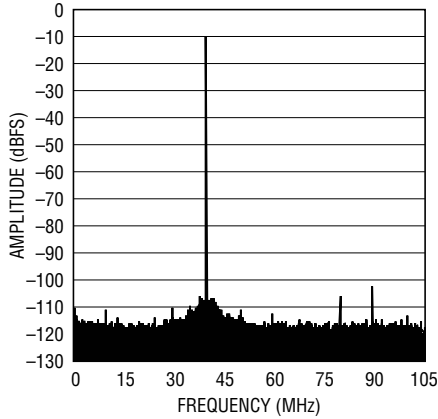

2107 G28

HD2/HD3 vs Input Frequency,  $\text{PGA} = 0$ ,  $-1\text{dBFS}$

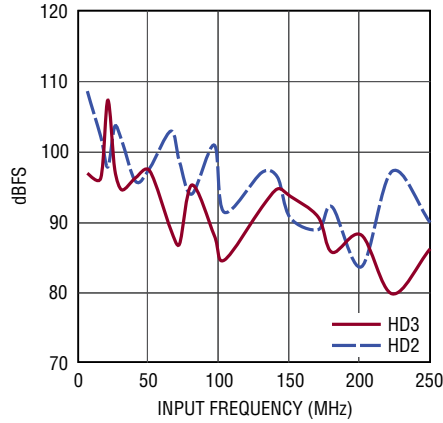

2107 G29

HD2/HD3 vs Input Frequency,  $\text{PGA} = 1$ ,  $-1\text{dBFS}$

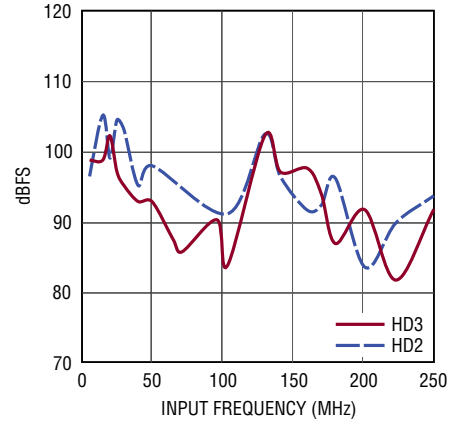

2107 G30

SNR vs Input Frequency

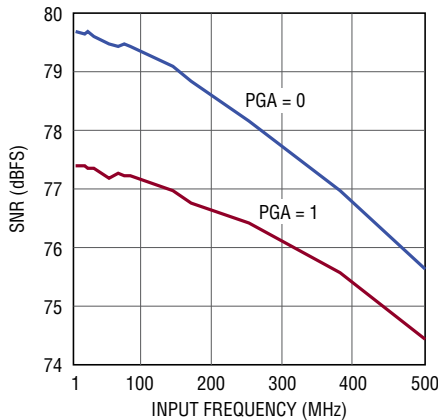

2107 G31

SNR and SFDR vs Sample Rate,  $f_{IN} = 5\text{MHz}$ ,  $-1\text{dBFS}$

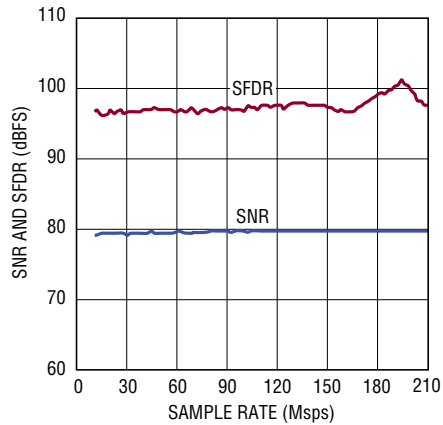

2107 G32

SNR and SFDR vs Supply Voltage ( $V_{DD}$ ),  $f_{IN} = 5\text{MHz}$ ,  $-1\text{dBFS}$

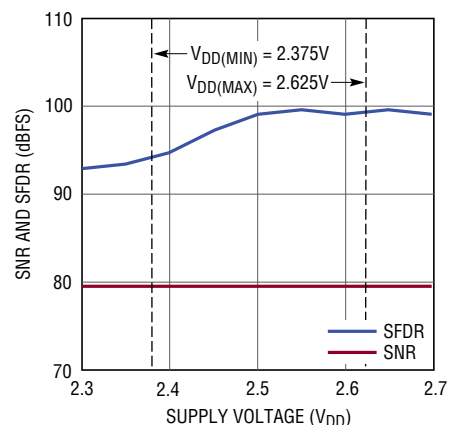

2107 G33

$I_{VDD}$  vs Sample Rate, 5MHz Sine Wave,  $-1\text{dBFS}$

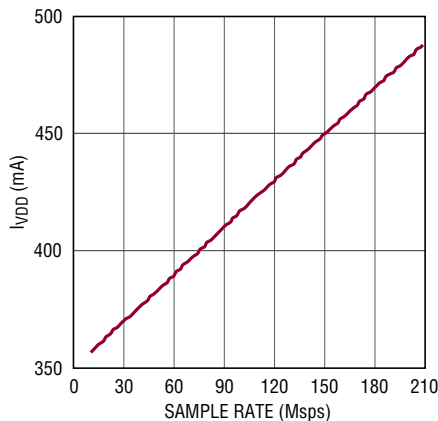

2107 G34

Normalized Full Scale vs Temperature, Internal Reference, 5 Units

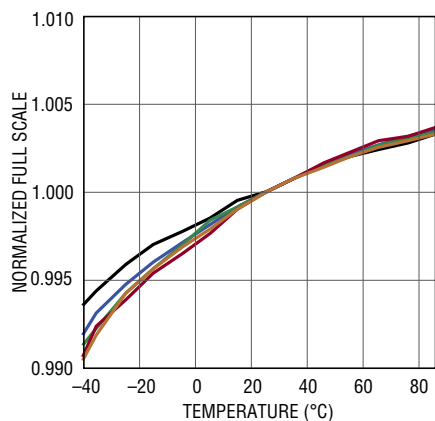

2107 G35

Normalized Full Scale vs Temperature, External Reference, 5 Units

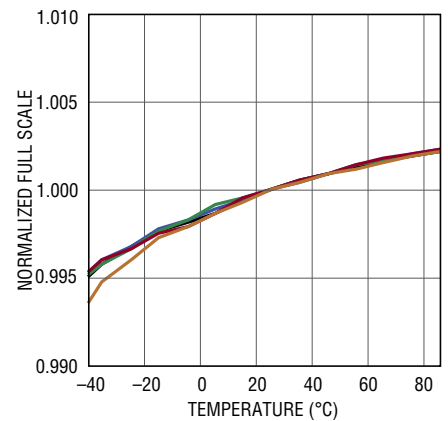

2107 G36

# TYPICAL PERFORMANCE CHARACTERISTICS

**Input Offset Voltage vs Temperature, 5 Units**

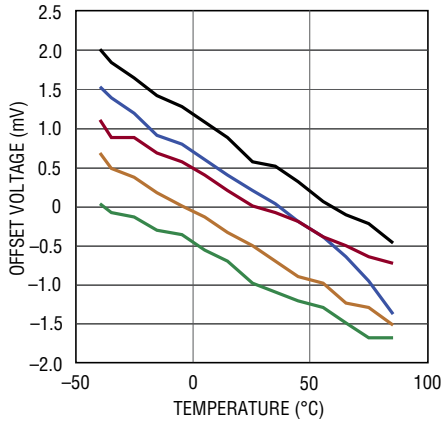

2107 G37

**SFDR vs Analog Input Common Mode Voltage, -1dBFS**

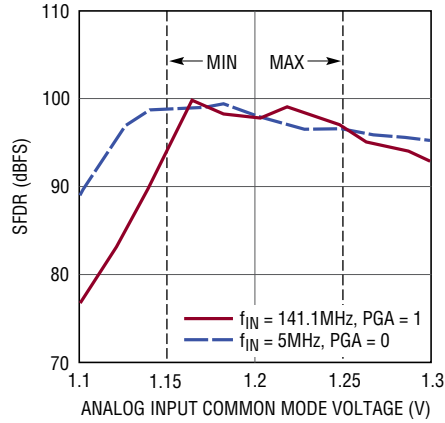

2107 G38

**Mid-Scale Settling After Wake Up from Shutdown**

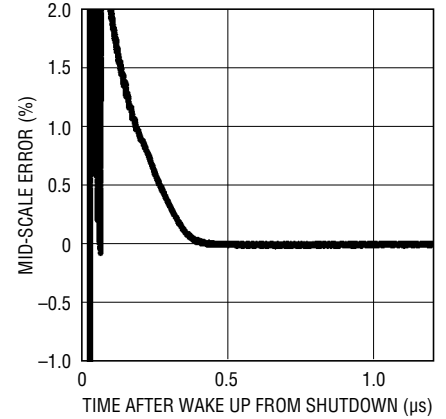

2107 G39

**Mid-Scale Settling After Starting Encode Clock with Keep-Alive On**

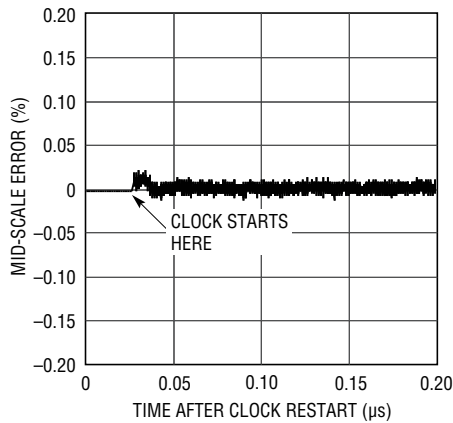

2107 G40

**Mid-Scale Settling After Starting Encode Clock with Keep-Alive Off**

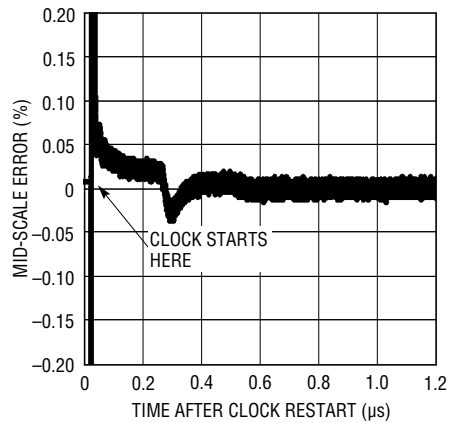

2107 G41

## PIN FUNCTIONS

### (Pins That Are the Same for All Digital Output Modes)

**SENSE (Pin 1):** Reference Programming Pin. The SENSE pin voltage selects the use of an internal reference or an external 1.25V reference. Connecting SENSE to ground or  $V_{DD}$  selects the internal reference. Connect SENSE to a 1.25V external reference and the external reference mode is automatically selected. The external reference must be  $1.25V \pm 25mV$  for proper operation.

**GND (Pins 2, 3, 7, 10, 12, 13, 16, 47, 48, 49):** ADC Power Ground.

**$V_{DD}$  (Pins 4, 5, 6):** 2.5V Analog Power Supply. Bypass to ground with an 0402 10 $\mu$ F ceramic capacitor and an 0402 0.1 $\mu$ F ceramic capacitor as close to these pins as possible. Pins 4, 5 and 6 can share these two bypass capacitors.

**$A_{IN}^+$  (Pin 8):** Positive Differential Analog Input.

**$A_{IN}^-$  (Pin 9):** Negative Differential Analog Input.

**$V_{CM}$  (Pin 11):** Common Mode Bias Output, Nominally Equal to 1.2V.  $V_{CM}$  should be used to bias the common mode of the analog inputs. Bypass to ground with a 2.2 $\mu$ F ceramic capacitor.

**ENC<sup>+</sup> (Pin 14):** Encode Input. Conversion starts on the rising edge.

**ENC<sup>-</sup> (Pin 15):** Encode Complement Input. Conversion starts on the falling edge.

**SHDN (Pin 17):** Power Shutdown Pin. SHDN = 0V results in normal operation. SHDN = 2.5V results in powered-down analog circuitry and the digital outputs are set in high impedance state.

**SDO (Pin 18):** In serial programming mode, ( $\overline{PAR/SER} = 0V$ ), SDO is the serial interface data output. Data on SDO is read back from the mode control registers and can be latched on the falling edge of SCK. SDO is an open-drain NMOS output that requires an external 2k pull-up resistor to 1.8V-3.3V. If readback from the mode control registers is not needed, the pull-up resistor is not necessary and SDO can be left unconnected.

**OGND (Pins 19, 42):** Output Driver Ground. OGND and GND should be tied together with a common ground plane.

**$OV_{DD}$  (Pins 20, 41):** 1.8V Output Driver Supply. Bypass each  $OV_{DD}$  pin to ground with an 0402 1 $\mu$ F ceramic capacitor and an 0402 0.1 $\mu$ F ceramic capacitor. Place the bypass capacitors as close to these pins as possible. Pins 20 and 41 cannot share these bypass capacitors.

**SDI (Pin 43):** In serial programming mode, ( $\overline{PAR/SER} = 0V$ ), SDI is the serial interface data input. Data on SDI is clocked into the mode control registers on the rising edge of SCK. In the parallel programming mode ( $\overline{PAR/SER} = V_{DD}$ ), SDI becomes the digital output randomization control bit. When SDI is low, digital output randomization is disabled. When SDI is high, digital output randomization is enabled. SDI can be driven with 1.8V to 3.3V logic.

**SCK (Pin 44):** In serial programming mode, ( $\overline{PAR/SER} = 0V$ ), SCK is the serial interface clock input. In the parallel programming mode ( $\overline{PAR/SER} = V_{DD}$ ), SCK controls the programmable gain amplifier front-end, PGA. SCK low selects a front-end gain of 1, input range of 2.4V<sub>p-p</sub>. High selects a front-end gain of 1.5, input range of 1.6V<sub>p-p</sub>. SCK can be driven with 1.8V to 3.3V logic.

**$\overline{CS}$  (Pin 45):** In serial programming mode, ( $\overline{PAR/SER} = 0V$ ),  $\overline{CS}$  is the serial interface chip select input. When  $\overline{CS}$  is low, SCK is enabled for shifting data on SDI into the mode control registers. In the parallel programming mode ( $\overline{PAR/SER} = V_{DD}$ ),  $\overline{CS}$  controls the digital output mode. When  $\overline{CS}$  is low, the full-rate CMOS output mode is enabled. When  $\overline{CS}$  is high, the double data rate LVDS output mode (with 3.5mA output current) is enabled.  $\overline{CS}$  can be driven with 1.8V to 3.3V logic.

**$\overline{PAR/SER}$  (Pin 46):** Programming Mode Selection Pin. Connect to ground to enable the serial programming mode.  $\overline{CS}$ , SCK, SDI, SDO become a serial interface that control the A/D operating modes. Connect to  $V_{DD}$  to enable the parallel programming mode where  $\overline{CS}$ , SCK, SDI become parallel logic inputs that control a reduced set of the A/D operating modes.  $\overline{PAR/SER}$  should be connected directly to ground or the  $V_{DD}$  of the part and not be driven by a logic signal.

## PIN FUNCTIONS

### Full-Rate CMOS Output Mode

All pins below have CMOS output levels (OGND to  $OV_{DD}$ )

**CMOS Output Mode is only recommended for sample rates up to 100Msps.**

**D0-D15 (Pins 21-30, 33-38):** Digital Outputs. D15 is the MSB.

**CLKOUT<sup>-</sup> (Pin 31):** Inverted Version of CLKOUT<sup>+</sup>.

**CLKOUT<sup>+</sup> (Pin 32):** Data Output Clock. The digital outputs normally transition at the same time as the falling edge of CLKOUT<sup>+</sup>. The phase of CLKOUT<sup>+</sup> can also be delayed relative to the digital outputs by programming the mode control registers.

**DNC (Pin 39):** Do not connect this pin.

**OF (Pin 40):** Over/Under Flow Digital Output. OF is high when an overflow or underflow has occurred.

### Double Data Rate LVDS Output Mode

All pins below have LVDS output levels. The output current level is programmable. There is an optional internal 100 $\Omega$  termination resistor between the pins of each LVDS output pair.

**D0<sub>1</sub><sup>-</sup>/D0<sub>1</sub><sup>+</sup> to D14<sub>15</sub><sup>-</sup>/D14<sub>15</sub><sup>+</sup> (Pins 21/22, 23/24, 25/26, 27/28, 29/30, 33/34, 35/36, 37/38):** Double Data Rate Digital Outputs. Two data bits are multiplexed onto each differential output pair. The even data bits (D0, D2, D4, D6, D8, D10, D12, D14) appear when CLKOUT<sup>+</sup> is low. The odd data bits (D1, D3, D5, D7, D9, D11, D13, D15) appear when CLKOUT<sup>+</sup> is high.

**CLKOUT<sup>-</sup>/CLKOUT<sup>+</sup> (Pins 31/32):** Data Output Clock. The digital outputs normally transition at the same time as the falling and rising edges of CLKOUT<sup>+</sup>. The phase of CLKOUT<sup>+</sup> can also be delayed relative to the digital outputs by programming the mode control registers.

**OF<sup>-</sup>/OF<sup>+</sup> (Pins 39/40):** Over/Under Flow Digital Output. OF<sup>+</sup> is high when an overflow or underflow has occurred. OF<sup>-</sup> is an inverted version of OF<sup>+</sup>.

## BLOCK DIAGRAM

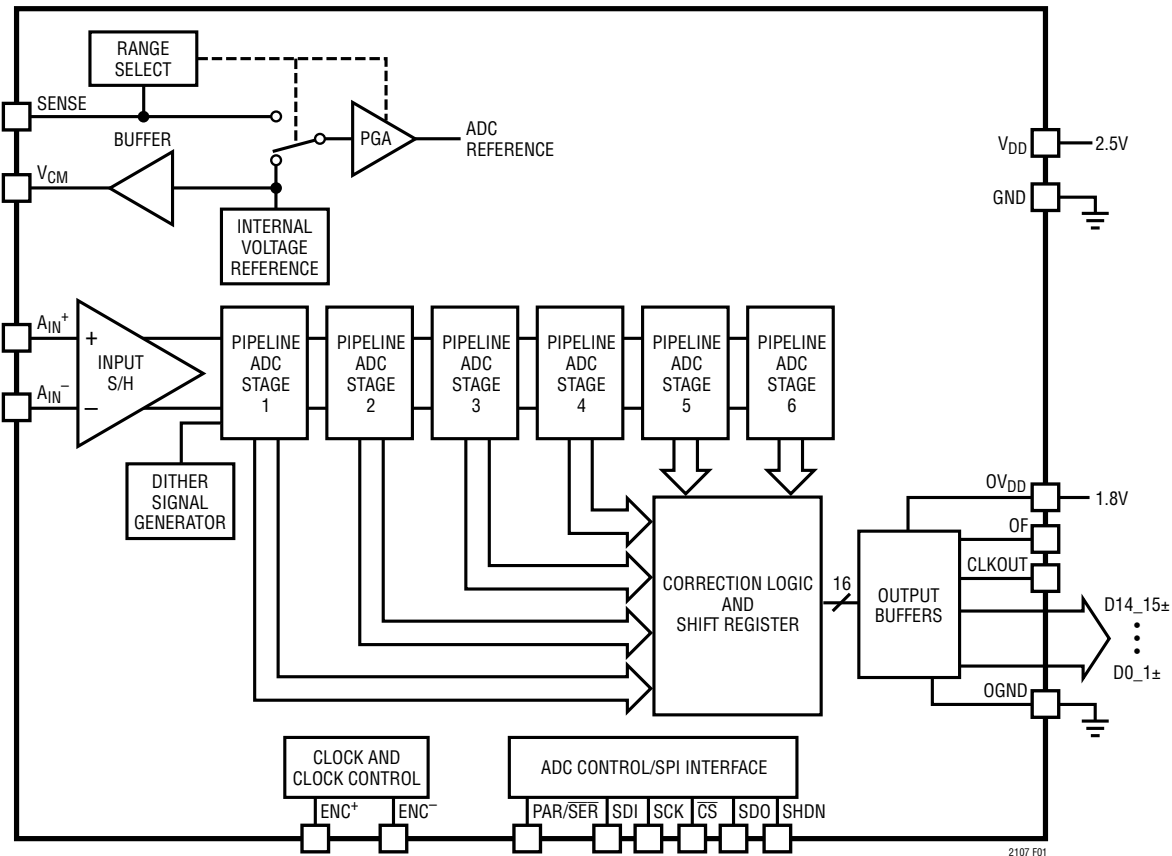

Figure 1. Functional Block Diagram

## APPLICATIONS INFORMATION

### CONVERTER OPERATION

The LTC2107 is a high performance pipelined 16-bit 210MSPS A/D converter with a direct sampling PGA front-end. As shown in Figure 1, the converter has six pipelined ADC stages; a sampled input will result in a digitized result seven cycles later (see the Timing Diagrams). The analog input is differential for improved common mode noise rejection, even order harmonic reduction and for maximum input voltage range. The encode input is also differential for common mode noise rejection and for optimal jitter performance. The digital outputs can be CMOS or double data rate LVDS (to reduce digital noise in the system.)

Many additional features can be chosen by programming the mode control registers through a serial SPI port.

The LTC2107 has two phases of operation, determined by the state of the differential  $ENC^+/ENC^-$  input pins. For brevity, the text will refer to  $ENC^+$  greater than  $ENC^-$  as ENC high and  $ENC^+$  less than  $ENC^-$  as ENC low.

Successive stages process the signal on a different phase over the course of seven clock cycles in order to create a digital representation of the analog input.

When ENC is low, the analog input is sampled differentially, directly onto the input sample-and-hold (S/H) capacitors,



## APPLICATIONS INFORMATION

inside the “Input S/H” shown in the Block Diagram. At the instant the ENC transitions from low to high, the voltage on the sample capacitors is held. While ENC is high, the held input voltage is buffered by the S/H amplifier which drives the first pipelined ADC stage. The first stage acquires the output of the S/H amplifier during the high phase of ENC. When ENC goes back low, the first stage produces its output which is acquired by the second stage. At the same time, the input S/H goes back to acquiring the next analog input. When ENC goes back high again, the second stage produces its output which is acquired by the third stage. The identical process is repeated for the remaining stages 3-5 finally resulting in an output at the output of the 5th stage which is sent to the 6th ADC stage for final evaluation.

Results from all stages are digitally delayed such that stage results are aligned with one analog input sample. The delayed results from all stages are then combined in the correction logic and the final result is sent to the output buffers.

### SAMPLE/HOLD OPERATION

Figure 2 shows the equivalent circuit for the LTC2107 direct sampling, differential sample/hold circuit. The differential analog inputs,  $A_{IN}^+$  and  $A_{IN}^-$  are sampled directly on to the sampling capacitors ( $C_{SAMPLE}$ ) through NMOS transistor switches. The capacitors shown attached to each input ( $C_{PAR}$ ) are the summation of all other capacitance associated with each input, for interconnect and device parasitics.

During the sample phase, when ENC is low, the NMOS switches connect the analog inputs to the sampling capacitors, such that they charge to, and track the input voltage. The capacitance seen at the input during the sample phase is the sum of  $C_{SAMPLE}$  and  $C_{PAR}$  or 6.38pF. When ENC transitions from low to high, the NMOS switches open, disconnecting the analog inputs from the sampling capacitors. The voltage on the sampling capacitors is held and is passed to the ADC core for evaluation. The capacitance seen at the input during the hold phase is  $C_{PAR}$  or 0.66pF.

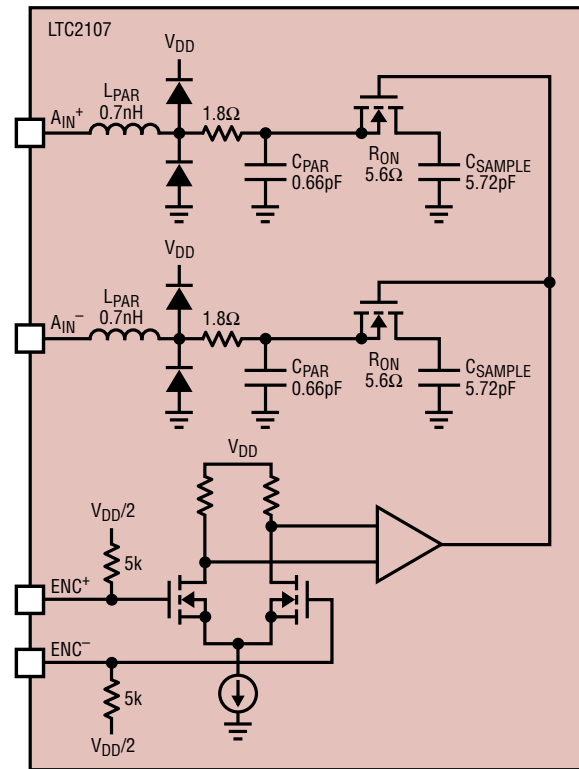

2107 F02

Figure 2. Equivalent Input Circuit

### Sampling Glitch

As ENC transitions from high to low, the inputs are re-connected to the sampling capacitors to acquire a new sample. Since the sampling capacitors still hold the previous sample, the analog inputs must supply a charge that is proportional to the change in voltage between the current sample and the previous sample. Additionally there is a fixed charge associated with the turn-on of the NMOS sampling switches.

Ideally, the input circuitry should be fast enough to fully charge the sampling capacitor during the sampling period  $1/2f_{ENCODE}$ . However, this is not always possible and the incomplete settling may degrade the SFDR. The sampling glitch has been designed to be as linear as possible to minimize the effects of incomplete settling.

## APPLICATIONS INFORMATION

Particular care has to be taken when driving the ADC with test equipment involving long BNC cables. Such a situation can create reflections in the BNC cable which will degrade SFDR. Connecting a 3dB attenuator pad at the input to the demo board will help mitigate this problem.

### Drive Impedance

As with all high performance, high speed ADCs the dynamic performance of the LTC2107 can be influenced by the input drive circuitry, particularly the second and third harmonics. Source impedance and input reactance can influence SFDR. At the falling edge of ENC the sample and hold circuit will connect the 5.72pF sampling capacitor to the input pin and start the sampling period. The sampling period ends when ENC rises, holding the sampled input on the sampling capacitor.

The analog input drive impedance will affect sampling bandwidth and settling time. The input impedance of the LTC2107 is primarily capacitive for frequencies below 1GHz. Higher source impedance will result in slower settling and lower sampling bandwidth. The sampling bandwidth is typically 800MHz with a source impedance of 25 $\Omega$ .

Better SFDR results from lower input impedance. For the best performance it is recommended to have a source impedance of 50 $\Omega$  or less for each input. The source impedance should be matched for the differential inputs. Poor matching will result in higher even order harmonics, especially the second.

### PGA Function

The LTC2107 has a programmable gain amplifier sample/hold circuit. The gain can be controlled through the serial or parallel modes of operation. PGA = 0 selects a sample/hold gain of 1 and an input range of 2.4V<sub>P-P</sub>. PGA = 1 selects a sample/hold gain of 1.5 and an input range of 1.6V<sub>P-P</sub>. The PGA setting allows flexibility for ADC drive optimization. A lower ADC input signal eases the OIP3 requirements of the ADC driver circuit. The lower input range of the PGA = 1 setting is easier to drive and has lower distortion for high frequency applications. For PGA = 1, SNR is lower by 2.3dB as compared to PGA = 0; however the input referred noise is improved by 1.2dB.

**Table 1. PGA settings**

	PGA = 0	PGA = 1	UNIT
Input Range	2.4	1.6	V <sub>P-P</sub>
SNR, Idle Channel	80	77.7	dBFS
Input Referred Noise	85	74	$\mu$ V <sub>RMS</sub>

### INPUT DRIVE CIRCUITS

The inputs should be driven differentially around a common mode voltage set by the V<sub>CM</sub> output pin, which is nominally 1.2V. For the 2.4V input range, the inputs should swing from V<sub>CM</sub> – 0.6V to V<sub>CM</sub> + 0.6V. There should be 180° phase difference between the inputs.

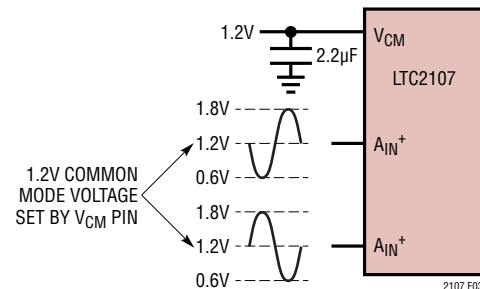

**Figure 3. Input Voltage Swings for the 2.4V Input Range**

### Transformer Coupled Circuits

RF transformers offer a simple, low noise, low power, and low distortion method for single-ended to differential conversion, as well as voltage gain and impedance transformation. Figure 4 shows the analog input being driven by a transmission line transformer and flux-coupled transformer combination circuit. The secondary coil of the flux-coupled transformer is biased with V<sub>CM</sub>, setting the A/D input at its optimal DC level. There is always a source impedance in front of the ADC seen by its input pins A<sub>IN</sub><sup>+</sup> and A<sub>IN</sub><sup>-</sup>. Source impedance greater than 50 $\Omega$  can reduce the input bandwidth and increase high frequency distortion. A disadvantage of using a transformer is the signal loss at low frequencies. Most small RF transformers have poor performance at frequencies below 1MHz.

At higher input frequencies a single transmission line balun transformer is used (Figures 5 to 6).

## APPLICATIONS INFORMATION

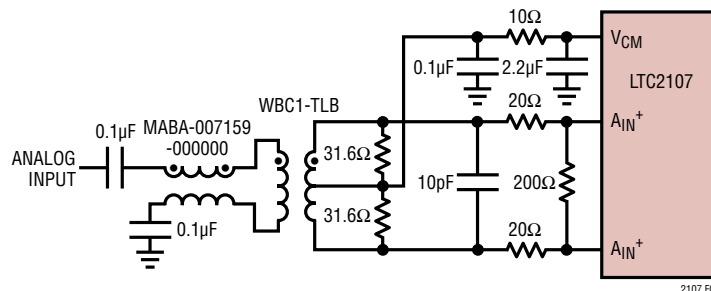

**Figure 4. Single-Ended to Differential Conversion Using Two Transformers. Recommended for Input Frequencies from 5MHz to 100MHz**

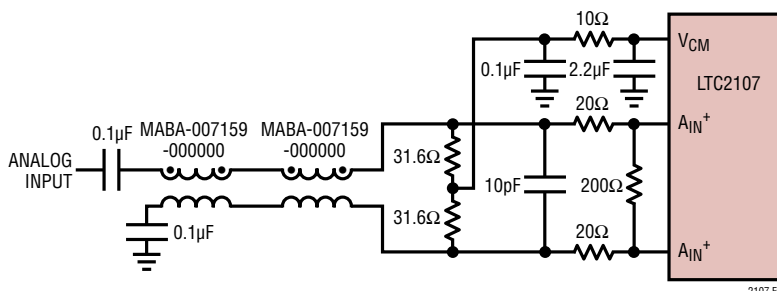

**Figure 5. Single-Ended to Differential Conversion Using Two Transformers. Recommended for Input Frequencies from 100MHz to 250MHz**

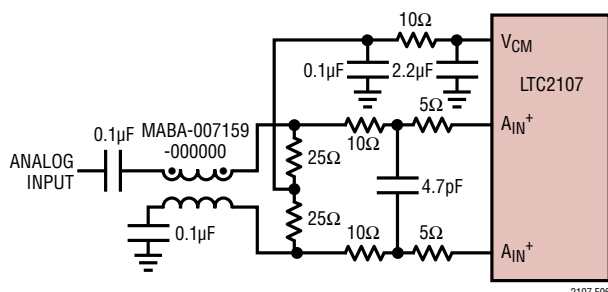

**Figure 6. Single-Ended to Differential Conversion Using One Transformer. Recommended for Input Frequencies Above 250MHz**

### Dither

The dither function enhances the SFDR performance of the LTC2107. Dither can be turned on by writing a “1” to register A1[2]. For brevity, the text will refer to  $A_{IN}^+ - A_{IN}^-$  as  $A_{IN}$ . The dither function adds a pseudorandom dither voltage to the sampled analog input at the front of

the ADC, yielding  $A_{IN} + \text{dither}$ . This signal is converted by the ADC, yielding  $A_{IN} + \text{dither}$  in digital format. Dither is then subtracted, yielding the  $A_{IN}$  value at the output of the ADC in 16 bit resolution. The dither function is invisible to the user. The input signal range of the ADC is not affected when dither is turned on.

### Reference

The LTC2107 has an internal 1.25V voltage reference. Connecting SENSE to  $V_{DD}$  or GND selects use of the internal 1.25V reference. The SENSE pin is also the input for an external 1.25V reference. Figure 7 shows how an external 1.25V reference voltage or the internal 1.25V reference can be used. Figure 8 shows how an external 1.25V reference voltage can be configured. Either internal or external reference will result in an ADC input range of  $2.4V_{P-P}$  with  $PGA = 0$ .

## APPLICATIONS INFORMATION

TIE SENSE TO 0V OR  $V_{DD}$  TO USE THE INTERNAL 1.25V REFERENCE  
TIE SENSE TO A 1.25V REFERENCE TO USE AN EXTERNAL REFERENCE

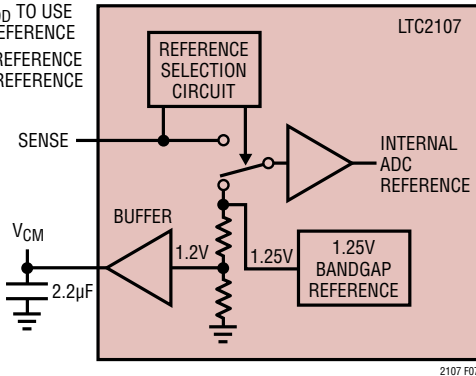

Figure 7. Reference Circuit.

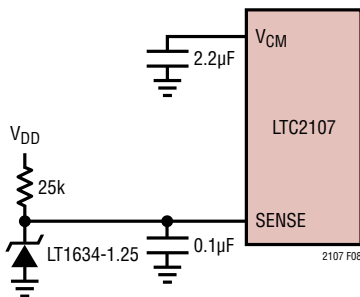

Figure 8. Using an external 1.25V reference.

### Encode Input

The signal quality of the differential encode inputs strongly affects the A/D noise performance. The encode inputs should be treated as analog signals—do not route them next to digital traces on the circuit board. Sinusoidal, PECL, or LVDS encode inputs can be used. The encode inputs are internally biased to 1.25V through 5k equivalent resistance. An optional 100Ω termination resistor can be

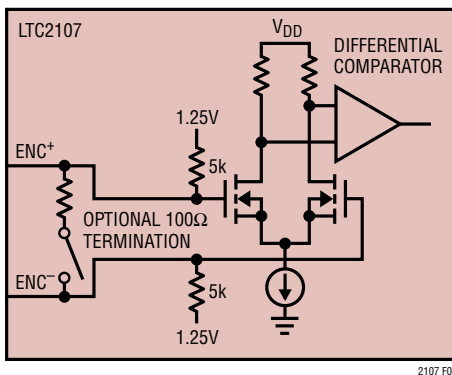

Figure 9. Equivalent Encode Input Circuit

turned on by writing a “1” to control register bit A3[5]. The encode inputs can be taken up to  $V_{DD}$ , and the common mode range is from 1.1V to 1.5V.

For good jitter performance a high quality, low jitter clock source should be used. A 2V<sub>P-P</sub> differential encode signal is recommended for optimum SNR performance. Refer to Figure 10 for clock source jitter requirements to achieve a desired SNR at a given input frequency.

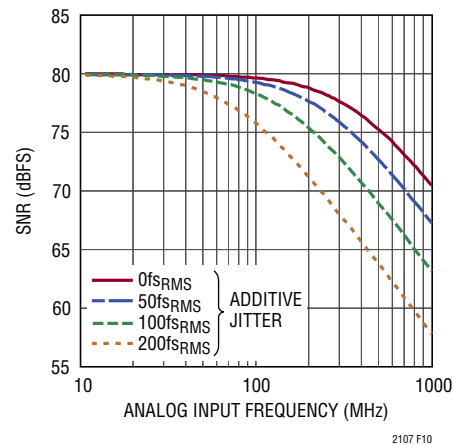

Figure 10. Ideal SNR Versus Analog Input Frequency and Clock Source Jitter

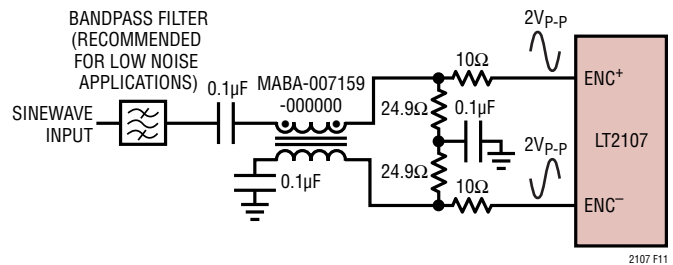

Figure 11. Sinusoidal Encode Drive

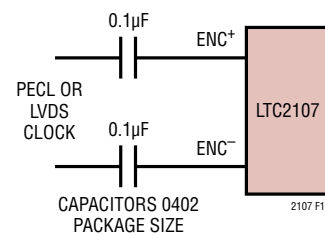

Figure 12. PECL or LVDS Encode Drive

## APPLICATIONS INFORMATION

### Clock Duty Cycle Stabilizer

The clock duty cycle stabilizer (DCS) is a circuit that produces a 50% duty cycle clock internal to the LTC2107 from a non 50% duty cycle encode input. The clock DCS is off by default and is enabled by writing a “1” to control register bit A3[0] (serial programming mode only). When the DCS is disabled optimum ADC performance is achieved when the encode signal has a 50% ( $\pm 5\%$ ) duty cycle. When the optional clock duty cycle stabilizer circuit is enabled, the encode duty cycle can vary from 30% to 70% and the duty cycle stabilizer will maintain a constant 50% internal duty cycle. If the encode signal changes frequency or is turned off and on again, the duty cycle stabilizer circuit requires approximately one hundred clock cycles to lock onto the input clock and maintain a steady state.

For applications where the sample rate needs to be changed quickly, the clock duty cycle stabilizer can be left disabled. If the duty cycle stabilizer is disabled, care should be taken to make the sampling clock have a 50% ( $\pm 5\%$ ) duty cycle.

### Keep-Alive Oscillator

There are many circuits on the LTC2107 which depend on the presence of a clock for refresh purposes, proper functionality and biasing. However an encode clock may not be available to the LTC2107 all of the time during operation.

The keep-alive oscillator ensures the presence of an on-chip 800kHz clock when an encode clock is not active at ENC<sup>+</sup>/ENC<sup>-</sup>. The keep-alive oscillator functionality is shown in Figure 13. The purpose of this function is to enable fast operation of the ADC when an encode clock does become active at the ENC<sup>+</sup>/ENC<sup>-</sup> pins. See the Mid-Scale and Full-Scale Settling performance plots for evidence of fast ADC recovery when the ENC<sup>+</sup>/ENC<sup>-</sup> clock becomes active. The keep-alive oscillator can be disabled by writing a “1” to A3[4]. In the event that the keep-alive oscillator is disabled and a clock is not active at the ENC<sup>+</sup>/ENC<sup>-</sup> pins there will be no on-chip clock active. This will also result in elevated input leakage current on the A<sub>IN</sub><sup>+</sup>/A<sub>IN</sub><sup>-</sup> pins.

## DIGITAL OUTPUTS

### Digital Output Modes

The LTC2107 can operate in two digital output modes: CMOS mode or double data rate LVDS mode. The output mode is set by mode control register A4[0] (serial programming mode), or by CS (parallel programming mode). LVDS mode is generally used to reduce digital noise on the printed circuit board.

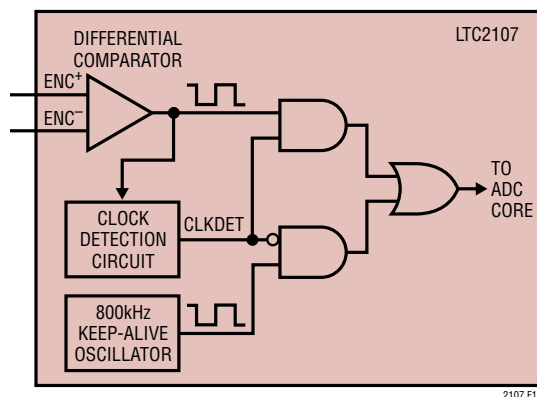

Figure 13. Functionality of Keep-Alive Oscillator

## APPLICATIONS INFORMATION

### CMOS Mode

In CMOS mode the 16 digital outputs (D0-D15), overflow (OF), and the data output clocks (CLKOUT<sup>+</sup>, CLKOUT<sup>-</sup>) have CMOS output levels. The outputs are powered by OV<sub>DD</sub> and OGND which are isolated from the A/D core power and ground.

For good performance the digital outputs should drive minimal capacitive loads. If the load capacitance is larger than 5pF a digital buffer should be used.

CMOS mode is not recommended for sampling rates greater than 100Msps.

### Double Data Rate LVDS Mode

In double data rate LVDS mode, two data bits are multiplexed and output on each differential output pair. There are eight LVDS ADC data output pairs: (D0\_1<sup>+</sup>/D0\_1<sup>-</sup> through D14\_15<sup>+</sup>/D14\_15<sup>-</sup>). Overflow (OF<sup>+</sup>/OF<sup>-</sup>) and the data output clock (CLKOUT<sup>+</sup>/CLKOUT<sup>-</sup>) each have an LVDS output pair.

By default the outputs are standard LVDS levels: 3.5mA output current and a 1.25V output common mode voltage. An external 100Ω differential termination resistor is required for each LVDS output pair. The termination resistors should be located as close as possible to the LVDS receiver.

The outputs are powered by OV<sub>DD</sub> and OGND which are isolated from the A/D core power and ground. In LVDS mode, OV<sub>DD</sub> should be 1.8V.

### Programmable LVDS Output Current

In LVDS Mode, the default output driver current is 3.5mA. This current can be adjusted by serially programming mode control register A4. Available current levels are 1.75mA, 2.1mA, 2.5mA, 3mA, 3.5mA, 4mA and 4.5mA.

### Optional LVDS Driver Internal Termination

In most cases using just an external 100Ω termination resistor will give excellent LVDS signal integrity. In addition, an optional internal 100Ω termination resistor can be enabled by serially programming mode control register A4[3]. The internal termination helps absorb any reflections caused by imperfect termination at the receiver. When the internal termination is enabled, the output driver current is doubled to maintain the same output voltage swing.

### Overflow Bit

The overflow output bit (OF) outputs a logic high when the analog input is either overranged or underranged. The overflow bit has the same pipeline latency as the data bits.

In Full-Rate CMOS mode OF is the overflow pin. In DDR LVDS mode OF<sup>-</sup>/OF<sup>+</sup> are the two differential overflow pins. Sustained over-range or under-range beyond 120% of full-scale, for more than 20,000 samples may produce erroneous ADC codes and an extended ADC recovery time.

### Phase Shifting the Output Clock

In full rate CMOS mode the data output bits normally change at the same time as the falling edge of CLKOUT<sup>+</sup>, so the rising edge of CLKOUT<sup>+</sup> can be used to latch the output data. In double data rate LVDS mode the data output bits normally change at the same time as the falling and rising edges of CLKOUT<sup>+</sup>. To allow adequate setup and hold time when latching the data, the CLKOUT<sup>+</sup> signal may need to be phase shifted relative to the data output bits. Most FPGAs have this feature—this is generally the best place to adjust the timing.

The LTC2107 can also phase shift the CLKOUT<sup>+</sup>/CLKOUT<sup>-</sup> signals by serially programming mode control register A3[2:1]. The output clock can be shifted by 0°, 45°, 90°.

## APPLICATIONS INFORMATION

or 135°. To use the phase shifting feature the clock duty cycle stabilizer must be turned on. Writing a “1” to A3[0] will invert the polarity of CLKOUT+ and CLKOUT-, independently of the phase shift. The combination of these two features enables phase shifts of 45° up to 315° (Figure 14).

### DATA FORMAT

Table 2 shows the relationship between the analog input voltage, the digital data output bits and the over-flow bit. By default the output data format is offset binary. The 2’s complement format can be selected by serially programming mode control register A5[0]

**Table 2. Output Codes vs Input Voltage**

A <sub>IN</sub> <sup>+</sup> – A <sub>IN</sub> <sup>-</sup> (2.4V RANGE)	OF	D15 – D0 (OFFSET BINARY)	D15 – D0 (2’S COMPLEMENT)
>1.2000000V	1	1111 1111 1111 1111	0111 1111 1111 1111
+1.1999634V	0	1111 1111 1111 1111	0111 1111 1111 1111
+1.1999268V	0	1111 1111 1111 1110	0111 1111 1111 1110
+0.0000366V	0	1000 0000 0000 0001	0000 0000 0000 0001
+0.0000000V	0	1000 0000 0000 0000	0000 0000 0000 0000
-0.0000366V	0	0111 1111 1111 1111	1111 1111 1111 1111
-0.0000732V	0	0111 1111 1111 1110	1111 1111 1111 1110
-1.1999634V	0	0000 0000 0000 0001	1000 0000 0000 0001
-1.2000000V	0	0000 0000 0000 0000	1000 0000 0000 0000
≤-1.2000000V	1	0000 0000 0000 0000	1000 0000 0000 0000

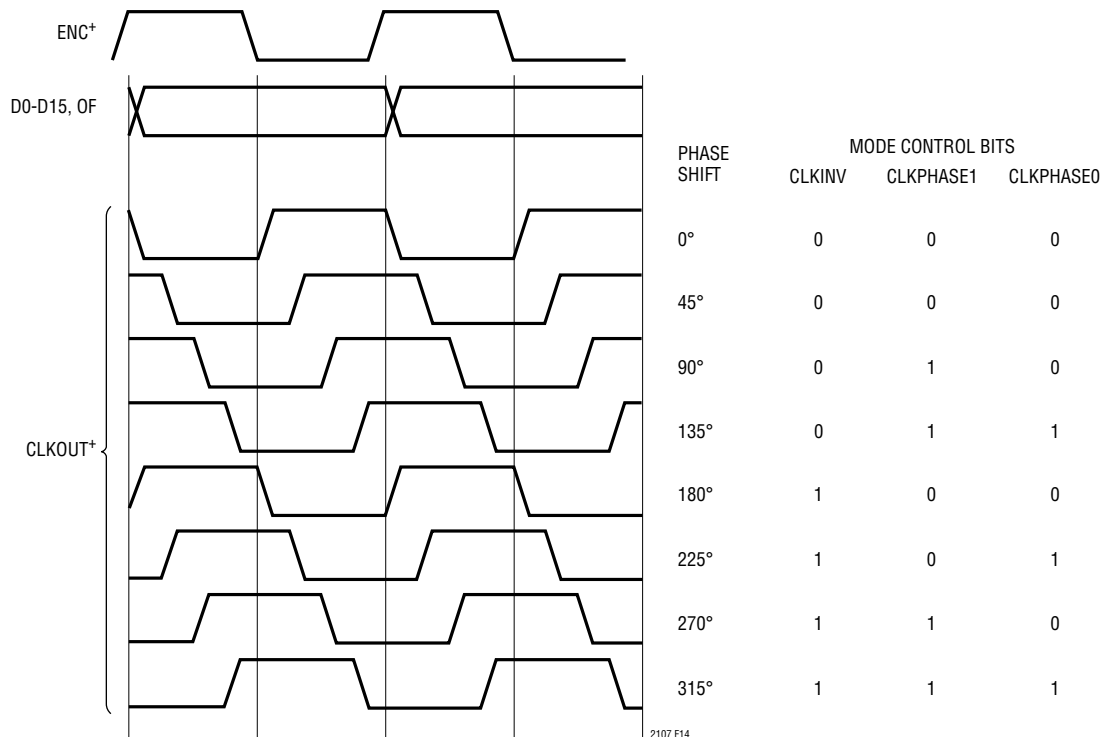

**Figure 14. Phase Shifting CLKOUT**



## APPLICATIONS INFORMATION

### Digital Output Randomizer

Interference from the A/D digital outputs is sometimes unavoidable. Digital interference may be from capacitive or inductive coupling or coupling through the ground plane. Even a tiny coupling factor can cause unwanted tones in the ADC output spectrum. By randomizing the digital output before it is transmitted off chip, these unwanted tones can be randomized which reduces the unwanted tone amplitude.

The digital output is “randomized” by applying an exclusive-OR logic operation between the LSB and all other data output bits. To decode, the reverse operation is applied—an exclusive-OR operation is applied between the LSB and all other bits. The LSB, OF and CLKOUT outputs are not affected. The output randomizer is enabled by serially programming mode control register A5[1].

### Alternate Bit Polarity

Another feature that reduces digital feedback on the circuit board is the alternate bit polarity mode. When this mode is enabled, all of the odd bits (D1, D3, D5, D7, D9, D11, D13, D15) are inverted before the output buffers. The even bits (D0, D2, D4, D6, D8, D10, D12, D14), OF and CLKOUT are not affected. This can reduce digital currents in the circuit board ground plane and reduce digital noise, particularly for very small analog input signals.

When there is a very small signal at the input of the A/D that is centered around mid-scale, the digital outputs toggle between mostly 1’s and mostly 0’s. This simultaneous switching of most of the bits will cause large currents in the ground plane. By inverting every other bit, the alternate bit polarity mode makes half of the bits transition high while half of the bits transition low. To first order, this cancels current flow in the ground plane, reducing the digital noise.

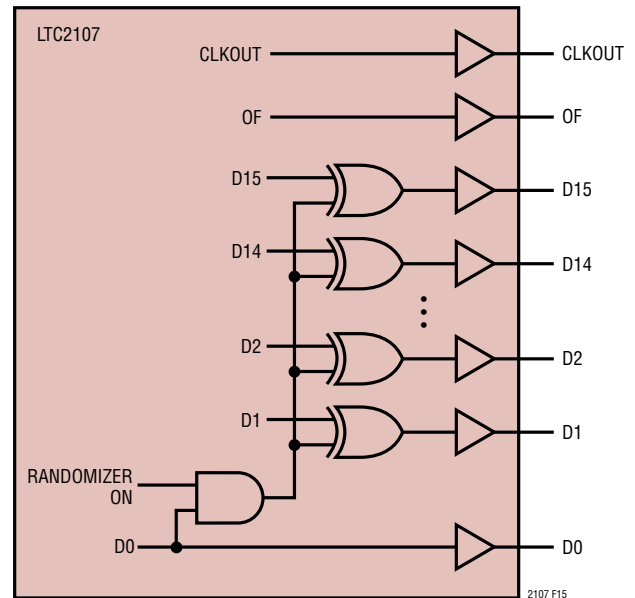

Figure 15. Functional Equivalent of Digital Output Randomizer

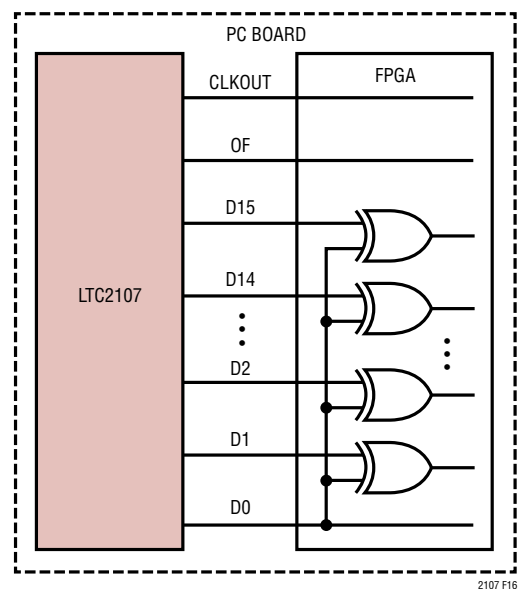

Figure 16. Unrandomizing a Randomized Digital Output Signal



## APPLICATIONS INFORMATION

The digital output is decoded at the receiver by inverting the odd bits (D1, D3, D5, D7, D9, D11, D13, D15). The alternate bit polarity mode is independent of the digital output randomizer—either, both or neither function can be on at the same time. The alternate bit polarity mode is enabled by serially programming mode control register A5[2].

### Digital Output Test Patterns

To allow in-circuit testing of the digital interface to the A/D, there are several test modes that force the A/D data outputs (OF, D15-D0) to known values:

All 1s: All outputs are 1

All 0s: All outputs are 0

Alternating: Outputs change from all 1s to all 0s on alternating samples.

Checkerboard: Outputs change from 101010101010101 to 010101010101010 on alternating samples.

The digital output test patterns are enabled by serially programming mode control register A5[5:3]. When enabled, the Test Patterns override all other formatting modes: 2's complement, randomizer, alternate-bit-polarity.

### Output Disable

The digital outputs may be disabled by serially programming mode control register A4[2]. All digital outputs including OF and CLKOUT are disabled. The high impedance disabled state is intended for long periods of inactivity—it is too slow to multiplex a data bus between multiple converters at full speed.

### Shutdown Mode

The A/D may be placed in shutdown mode to conserve power. In shutdown mode the entire A/D converter is powered down, resulting in 6.4mW power consumption. Shutdown mode is enabled by mode control register A1[1] (serial programming mode), or by SHDN (parallel or serial programming mode). The amount of time required to recover from shutdown is shown in the mid-scale settling performance plots.

## DEVICE PROGRAMMING MODES

The operating modes of the LTC2107 can be programmed by either a parallel interface or a simple serial interface. The serial interface has more flexibility and can program all available modes. The parallel interface is more limited and can only program some of the more commonly used modes.

### Parallel Programming Mode

To use the parallel programming mode,  $\overline{\text{PAR}}/\overline{\text{SER}}$  should be tied to  $V_{\text{DD}}$ . The  $\overline{\text{CS}}$ , SCK, SDI, and SHDN pins are binary logic inputs that set certain operating modes. These pins can be tied to  $V_{\text{DD}}$  or ground, or driven by 1.8V, 2.5V, or 3.3V CMOS logic. Table 3 shows the modes set by  $\overline{\text{CS}}$ , SCK, SDI and SHDN.

**Table 3. Parallel Programming Mode Control Bits**

PIN	DESCRIPTION
$\overline{\text{CS}}$	<b>Digital Output Mode Control Bit</b> 0 = Full Rate CMOS Digital Output Mode 1 = Double Data Rate (DDR) LVDS Output Modes
SCK	<b>Programmable Gain Front-End (PGA) Control Bit</b> 0 = Front-End Gain = 1 (FS = 2.4V <sub>p-p</sub> ) 1 = Front-End Gain = 1.5 (FS = 1.6V <sub>p-p</sub> )
SDI	<b>Digital Output Randomizer Control Bit</b> 0 = Digital Output Randomization Disabled 1 = Digital Output Randomization Enabled
SHDN	0 = Normal Operation 1 = ADC Power Shut Down

## APPLICATIONS INFORMATION

### Serial Programming Mode

To use the Serial Programming mode, the  $\overline{\text{PAR}}/\overline{\text{SER}}$  pin should be tied to ground. The  $\overline{\text{CS}}$ , SCK, SDI and SDO pins become the Serial Peripheral Interface (SPI) pins that program the A/D control registers. Data is written to a register with a 16-bit serial word. Data can also be read back from a register to verify its contents.

Serial data transfer starts when  $\overline{\text{CS}}$  is taken low. SCK must be low at the time of the falling edge of  $\overline{\text{CS}}$  for proper operation (see the SPI Timing Diagrams). The data on the SDI pin is latched at the first 16 rising edges of SCK. Any SCK rising edges after the first 16 are ignored. The data transfer ends when  $\overline{\text{CS}}$  is taken high again.

The first bit of the 16-bit input word is the  $\overline{\text{R}}/\overline{\text{W}}$  bit. The next 7 bits are the address of the register (A6:A0). The final 8 bits are the register data (D7:D0). If the  $\overline{\text{R}}/\overline{\text{W}}$  bit is low, the serial data (D7:D0) will be written to the register set by the address bits (A6:A0).

If the  $\overline{\text{R}}/\overline{\text{W}}$  bit is high, data in the register set by the address bits (A6:A0) will be read back on the SDO pin (see the SPI Timing Diagrams). During a read-back command the register is not updated and data on SDI is ignored.

The SDO pin is an open-drain output that pulls to ground through a 260 $\Omega$  resistance. If register data is read back through SDO, an external 2k pull-up resistor is required. If serial data is only written and read-back is not needed, SDO may be left floating and no pull-up resistor is needed.

Table 4 shows a map of the mode control registers.

### Software Reset

If serial programming is used, the mode control registers should be programmed as soon as possible after the power supplies turn on and are stable. The first serial command

must be a software reset which will reset all register data bits to logic 0. To perform a software reset, bit A0[7] in the reset register is written with a logic 1. After the reset is complete, bit A0[7] is automatically set back to zero. All serial control bits are set to zero after a reset.

### GROUNDING AND BYPASSING

The LTC2107 requires a printed circuit board with a clean unbroken ground plane. A multilayer board with an internal ground plane is recommended. Layout for the printed circuit board should ensure that digital and analog signal lines are separated as much as possible. In particular, care should be taken not to run any digital track alongside an analog signal track or underneath the ADC.

High quality ceramic bypass capacitors should be used at the  $V_{\text{DD}}$ ,  $0V_{\text{DD}}$ , and  $V_{\text{CM}}$  pins. Bypass capacitors must be located as close to the pins as possible. Size 0402 ceramic capacitors are recommended for the 0.1 $\mu\text{F}$ , 1 $\mu\text{F}$ , 2.2 $\mu\text{F}$  and 10 $\mu\text{F}$  decoupling capacitors. The traces connecting the pins and bypass capacitors must be kept short and should be made as wide as possible.

The analog inputs, encode signals, and digital outputs should not be routed next to each other. Ground fill and grounded vias should be used as barriers to isolate these signals from each other.

### HEAT TRANSFER

Most of the heat generated by the LTC2107 is transferred from the die through the bottom-side exposed pad and package leads onto the printed circuit board. For good electrical and thermal performance, the exposed pad must be soldered to a large grounded pad on the PC board.

## APPLICATIONS INFORMATION

Table 4. Serial Programming Mode Register Map

### REGISTER A0: RESET REGISTER (ADDRESS 00h)

D7	D6	D5	D4	D3	D2	D1	D0
RESET	X	X	X	X	X	X	X

- Bits 7      **RESET**      Software Reset Bit  
 0 = Not Used  
 1 = Software Reset. All Mode Control Registers are reset to 00h. This bit is automatically set back to zero after the reset is complete. The Reset Register is Write Only.
- Bits 6-0      Unused Bits. Read back as 0.

### REGISTER A1: ADC CONTROL REGISTER (ADDRESS 01h)

D7	D6	D5	D4	D3	D2	D1	D0
X	X	X	X	PGA	$\overline{\text{DITH}}$	SHDN	X

- Bits 7-4,0      Unused Bits. Read back as 0.
- Bit 3      **PGA**      Programmable Gain Front-End Control Bit  
 0 = Front-End Gain of 1. Default value at start-up.  
 1 = Front-End Gain of 1.5
- Bit 2      **DITH**      Dither Control Bit  
 0 = Dither Enabled. Default value at start-up.  
 1 = Dither Disabled
- Bit 1      **SHDN**      ADC Power Shut Down Control Bit  
 0 = Normal Operation. Default value at start-up.  
 1 = ADC Power Shut Down

## APPLICATIONS INFORMATION

### REGISTER A2: NOT USED (ADDRESS 02h)

D7	D6	D5	D4	D3	D2	D1	D0
X	X	X	X	X	X	X	X

Bits 7-0 Unused Bits. Read back as 0.

### REGISTER A3: CLOCK CONTROL REGISTER (ADDRESS 03h)

D7	D6	D5	D4	D3	D2	D1	D0
X	X	Encode Term	$\overline{\text{KAOSC}}$	CLKINV	CLKPHASE1	CLKPHASE0	DCS

Bits 7-6 Unused Bits. Read back as 0.

Bit 5  $100\Omega$  clock encode termination

0 = Clock Encode Termination Off. Default value at start-up.  
1 = Clock Encode Termination On.

Bit 4 **KAOSC** Keep Alive Oscillator Control Bit

0 = Keep Alive Oscillator Enabled. Default value at start-up.  
1 = Keep Alive Oscillator Disabled.

Bit 3 **CLKINV** Output Clock Invert Bit

0 = Normal CLKOUT Polarity (as shown in the timing diagrams). Default value at startup.  
1 = Inverted CLKOUT Polarity.

Bits 2-1 **CLKPHASE1:CLKPHASE0** Output Clock Phase Delay Bits

00 = No CLKOUT Delay (as shown in the timing diagrams). Default value at start-up.  
01 = CLKOUT+/CLKOUT- Delayed by  $45^\circ$  (Clock Period  $\times 1/8$ )  
10 = CLKOUT+/CLKOUT- Delayed by  $90^\circ$  (Clock Period  $\times 1/4$ )  
11 = CLKOUT+/CLKOUT- Delayed by  $135^\circ$  (Clock Period  $\times 3/8$ )

Note: If the CLKOUT Phase Delay feature is used, the clock duty cycle stabilizer must also be turned on.

Bit 0 **DCS** Clock Duty Cycle Stabilizer Control Bit

0 = Clock Duty Cycle Stabilizer Off. Default value at start-up.  
1 = Clock Duty Cycle Stabilizer On.

## APPLICATIONS INFORMATION

### REGISTER A4: OUTPUT MODE REGISTER (ADDRESS 04h)

D7	D6	D5	D4	D3	D2	D1	D0
X	ILVDS2	ILVDS1	ILVDS0	TERMON	OUTOFF	X	LVDS

Bit 7 Unused Bit. Read back as 0.

Bits 6-4 **ILVDS2:ILVDS0** LVDS Output Current Control Bits

000 = 3.5mA LVDS Output Driver Current. Default value at start-up.

001 = 4.0mA LVDS Output Driver Current.

010 = 4.5mA LVDS Output Driver Current.

011 = Not Used.

100 = 3.0mA LVDS Output Driver Current.

101 = 2.5mA LVDS Output Driver Current.

110 = 2.1mA LVDS Output Driver Current.

111 = 1.75mA LVDS Output Driver Current.

Bit 3 **TERMON** LVDS Internal Termination Bit

0 = Internal Termination Off. Default value at start-up.

1 = Internal Termination On. LVDS output driver current is 2× the current set by ILVDS2:ILVDS0

Bit 2 **OUTOFF** Output Disable Bit

0 = Digital Outputs are Enabled. Default value at start-up.

1 = Digital Outputs are Disabled and Have High Output Impedance.

Bit 1 Unused Bit. Read back as 0.

Bit 0 **LVDS** Digital Output Mode Control Bit

0 = Double Data Rate LVDS Output Mode. Default value at start-up.

1 = Full-Rate CMOS Output Mode.

### REGISTER A5: DATA FORMAT REGISTER (ADDRESS 05h)

D7	D6	D5	D4	D3	D2	D1	D0
X	X	OUTTEST2	OUTTEST1	OUTTEST0	ABP	RAND	TWOSCOMP

Bits 7-6 Unused Bits. Read back as 0.

Bits 5-3 **OUTTEST2:OUTTEST0** Digital Output Test Pattern Bits

000 = Digital Output Test Patterns Off. Default value at start-up.

001 = All Digital Outputs = 0.

011 = All Digital Outputs = 1.

101 = Checkerboard Output Pattern. OF, D15-D0 alternate between 10101 0101 0101 0101 and 01010 1010 1010 1010.

111 = Alternating Output Pattern. OF, D15-D0 alternate between 00000 0000 0000 0000 and 11111 1111 1111 1111.

Note: Other bit combinations are not used

Bit 2 **ABP** Alternate Bit Polarity Mode Control Bit

0 = Alternate Bit Polarity Mode Off. Default value at start-up.

1 = Alternate Bit Polarity Mode On.

Bit 1 **RAND** Data Output Randomizer Mode Control Bit

0 = Data Output Randomizer Mode Off. Default value at start-up.

1 = Data Output Randomizer Mode On.

Bits 0 **TWOSCOMP** Two's Complement Mode Control Bit

0 = Offset Binary Data Format. Default value at start-up.

1 = Two's Complement Data Format.

## PACKAGE DESCRIPTION

Please refer to <http://www.linear.com/product/LTC2107#packaging> for the most recent package drawings.

**UK Package**  
**48-Lead Plastic QFN (7mm × 7mm)**  
 (Reference LTC DWG # 05-08-1704 Rev C)

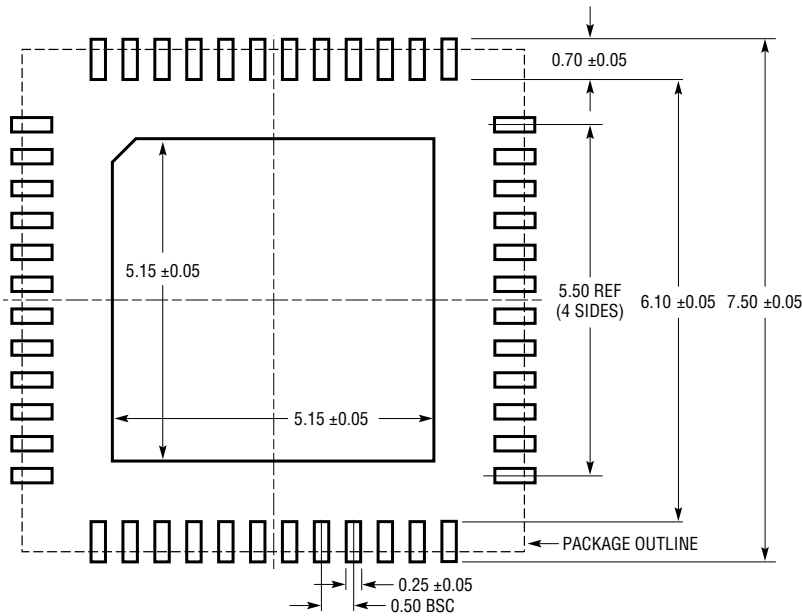

RECOMMENDED SOLDER PAD PITCH AND DIMENSIONS  
 APPLY SOLDER MASK TO AREAS THAT ARE NOT SOLDERED

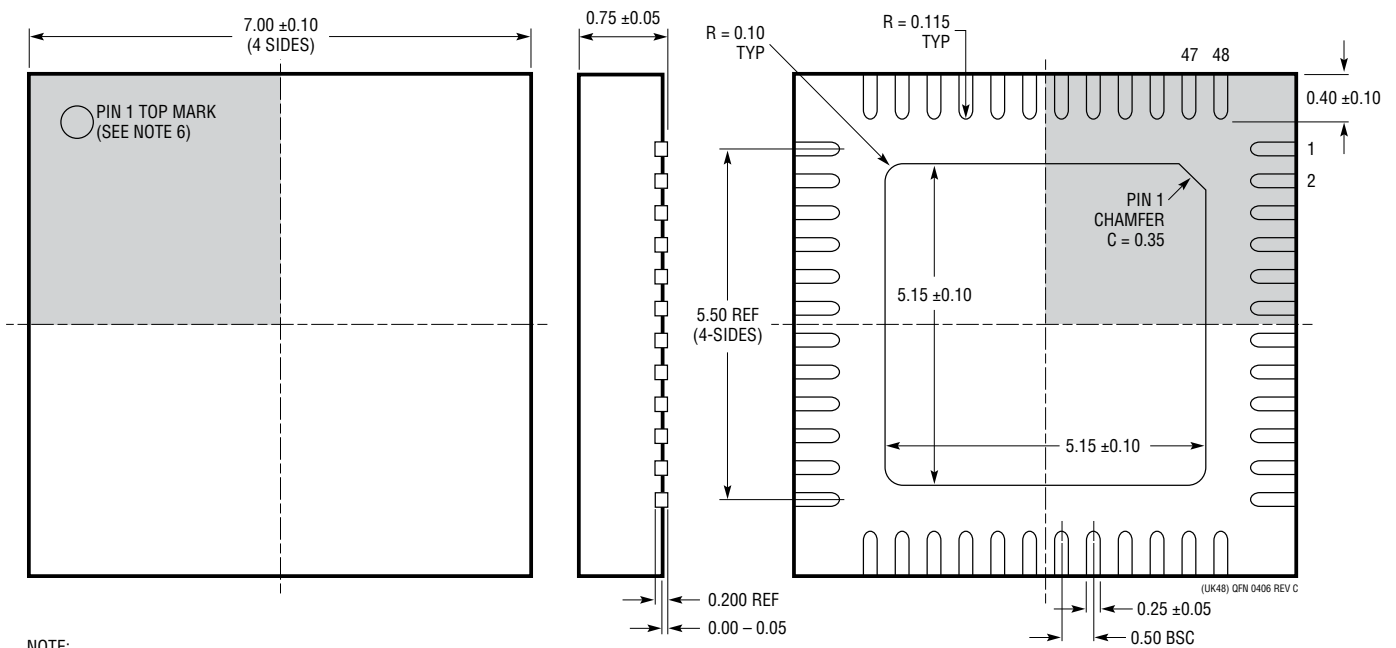

- NOTE:
1. DRAWING CONFORMS TO JEDEC PACKAGE OUTLINE MO-220 VARIATION (WKKD-2)
  2. DRAWING NOT TO SCALE
  3. ALL DIMENSIONS ARE IN MILLIMETERS
  4. DIMENSIONS OF EXPOSED PAD ON BOTTOM OF PACKAGE DO NOT INCLUDE MOLD FLASH. MOLD FLASH, IF PRESENT, SHALL NOT EXCEED 0.20mm ON ANY SIDE, IF PRESENT
  5. EXPOSED PAD SHALL BE SOLDER PLATED
  6. SHADED AREA IS ONLY A REFERENCE FOR PIN 1 LOCATION ON THE TOP AND BOTTOM OF PACKAGE

BOTTOM VIEW—EXPOSED PAD

## REVISION HISTORY

REV	DATE	DESCRIPTION	PAGE NUMBER
A	08/15	Updated the SPI Port Timing description, diagrams and programming information	6, 8 and 26
B	12/15	Updated Figure 13	21

## TYPICAL APPLICATION

LTC2107 Schematic (Serial Mode)

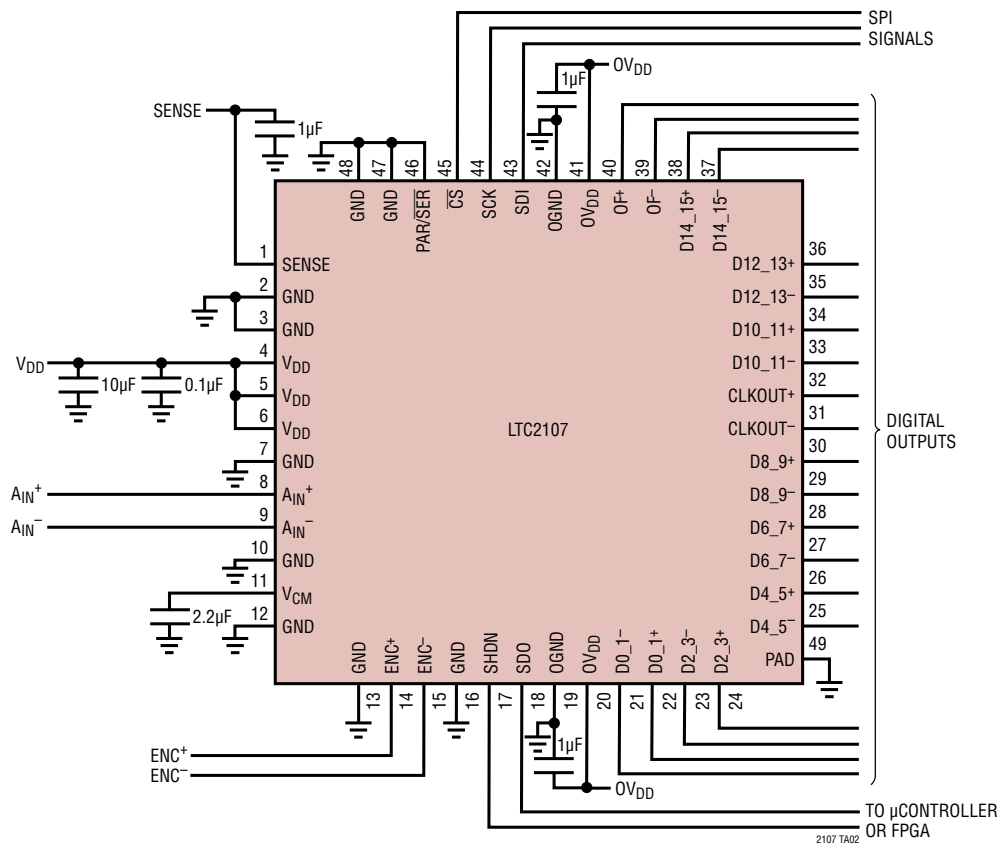

## RELATED PARTS

PART NUMBER	DESCRIPTION	COMMENTS
<b>High Speed ADCs</b>		
LTC2208	16-Bit 130Msps, 3.3V ADC	77.7dB SNR, 100dB SFDR, 1250mW, CMOS/LVDS Outputs, 9mm × 9mm QFN-64
LTC2209	16-Bit 160Msps, 3.3V ADC	77.1dB SNR, 100dB SFDR, 1530mW, CMOS/LVDS Outputs, 9mm × 9mm QFN-64
LTC2217	16-Bit 105Msps, 3.3V ADC	81.6dB SNR, 100dB SFDR, 1190mW, CMOS/LVDS Outputs, 9mm × 9mm QFN-64
LTC2195	16-Bit 125Msps, 1.8V Dual ADC, Ultralow Power	76.8dB SNR, 90dB SFDR, 432mW, Serial LVDS Outputs, 7mm × 8mm QFN-52
LTC2271	16-Bit 20Msps, 1.8V Dual ADC, Ultralow Power	84.1dB SNR, 99dB SFDR, 185mW, Serial LVDS Outputs, 7mm × 8mm QFN-52
<b>Fixed Gain IF Amplifiers/ADC Drivers</b>		
LTC6430-15	High Linearity Differential RF/IF Amplifier/ADC Driver	15dB Gain, +50dBm OIP3, 3dB NF at 240MHz, 5V/160mA Supply
<b>Baseband Differential Amplifiers</b>		
LTC6409	1.1nV/√Hz Single Supply Differential Amplifier/ADC Driver	88dB SFDR at 100MHz, AC- or DC-Coupled Inputs, 3mm × 2mm QFN-10
<b>RF Mixers</b>		
LTC5551	300MHz to 3.5GHz Ultrahigh Dynamic Range Mixer	+36dBm IIP3, 2.4dB Conversion Gain, 0dBm LO Drive, 670mW Total Power

2107fb



## X-ON Electronics

Largest Supplier of Electrical and Electronic Components

*Click to view similar products for [Analog to Digital Converters - ADC category](#):*

*Click to view products by [Analog Devices manufacturer](#):*

Other Similar products are found below :

[ADC0804LCD](#) [ADC0808](#) [MCP37211-200I/TE](#) [MAX15511TGTL+](#) [MCP33141-10T-E/MS](#) [MCP33141D-05T-E/MS](#) [MCP33151D-05T-E/MS](#)  
[MCP3202T-CI/MS](#) [MCP33141-05T-E/MS](#) [MCP33141D-10T-E/MS](#) [MCP33151-05T-E/MS](#) [MCP33151-10T-E/MS](#) [ADE1201ACCZ](#)  
[ADE1202ACCZ](#) [LTC1090CN](#) [LTC1605IG](#) [LTC1605AIG](#) [LTC2208IUP](#) [ADS1282HPW](#) [LTC1297DCN8](#) [LTC1741CFW](#) [MCP3422A0-](#)  
[E/MS](#) [MCP3426A2-E/MC](#) [MCP3426A3-E/MC](#) [MCP3427-E/MF](#) [TLC0820ACN](#) [TLC2543IN](#) [TLV2543IDW](#) [NCD9830DDBR2G](#)  
[ADS5231IPAG](#) [ADS7807U](#) [ADS7891IPFBT](#) [ADS8328IBPW](#) [AMC1204BDWR](#) [ADS7959QDBTRQ1](#) [ADS7807UB](#) [ADS7805UB](#)  
[ADS1220IPWR](#) [MCP3426A0-E/MS](#) [MCP3423-E/UN](#) [MCP3422A0-E/MC](#) [AD9220AR](#) [MAX11123ATI+](#) [MAX11212AEUB+](#)  
[MAX11135ATI+](#) [TLV1570CDW](#) [TLC3574IDWR](#) [TLC0838CDWR](#) [AD7714ARZ-5REEL](#) [AD7914BRUZ-REEL7](#)