

Quad Synchronous Step-Down Regulator: 2.25MHz, 300mA, 200mA, 200mA, 100mA

FEATURES

- High Efficiency: Up to 95%
- Four Independent Regulators Provide Up to 300mA, 200mA, 200mA and 100mA Output Current
- 2.25V to 5.5V Input Voltage Range
- 2.25MHz Constant Frequency Operation
- No Schottky Diodes Required
- Low Dropout Operation: 100% Duty Cycle
- Pulse Skipping at Low Load for Minimum Ripple
- 0.8V Reference Allows Low Output Voltages
- Shutdown Mode Draws <math><1\mu\text{A}</math> Supply Current
- Current Mode Operation for Excellent Line and Load Transient Response
- Overtemperature Protected
- Low Profile (3mm × 3mm) 16-Lead QFN Package

APPLICATIONS

- Cellular Telephones
- Personal Information Appliances
- Wireless and DSL Modems
- Digital Still Cameras
- Media Players
- Portable Instruments

DESCRIPTION

The LTC[®]3544B is a quad, high efficiency, monolithic synchronous buck regulator using a constant frequency, current mode architecture. The four regulators operate independently with separate run pins. The 2.25V to 5.5V input voltage range makes the LTC3544B well suited for single Li-Ion/polymer battery-powered applications. 100% duty cycle provides low dropout operation, extending battery runtime in portable systems. At moderate and low output load levels PWM pulse skip mode operation provides very low output ripple voltage for noise sensitive applications.

Switching frequency is internally set to 2.25MHz, allowing the use of small surface mount inductors and capacitors.

The internal synchronous switches increase efficiency and eliminate the need for external Schottky diodes. Low output voltages are easily supported with the 0.8V feedback reference voltage.

The LTC3544B is available in a low profile (0.75mm) (3mm × 3mm) QFN package.

LT, LT, LTC, LTM, Linear Technology and the Linear logo are registered trademarks of Linear Technology Corporation. All other trademarks are the property of their respective owners. Protected by U.S. Patents including 5481178, 6580258, 6304066, 6127815, 6498466, 6611131, 5994885.

TYPICAL APPLICATION

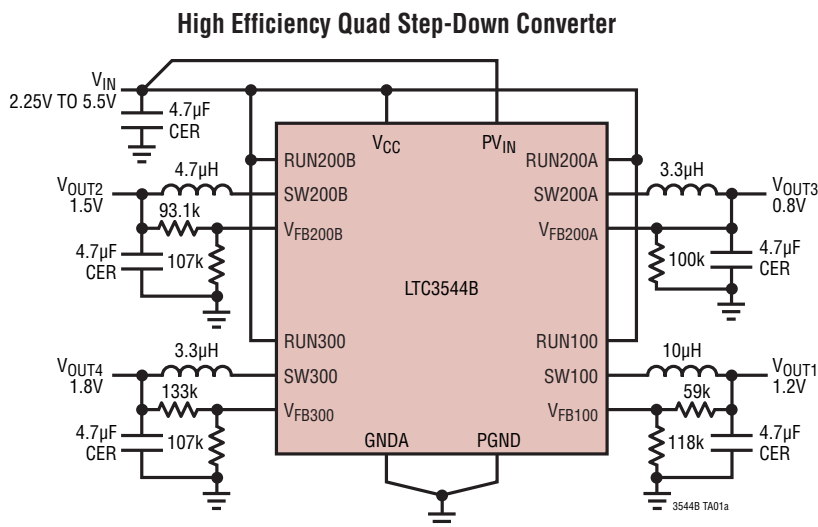

Efficiency vs Load Current, 300mA Channel, All Other Channels Off

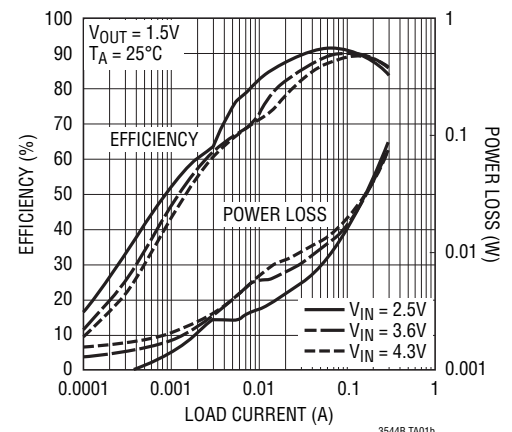

3544Bfb

LTC3544B

ABSOLUTE MAXIMUM RATINGS

(Note 1)

Input Supply Voltage	-0.3V to 6V
RUNx	-0.3V to ($V_{IN} + 0.3V$)
V_{FBx}	-0.3V to ($V_{IN} + 0.3V$)
SWx	-0.3V to ($V_{IN} + 0.3V$)
300mA P-Channel Source Current (DC) (Note 8) .	450mA
300mA N-Channel Sink Current (DC) (Note 8)	450mA
200mA P-Channel Source Current (DC) (Note 8) .	300mA
200mA N-Channel Sink Current (DC) (Note 8)	300mA
100mA P-Channel Source Current (DC) (Note 8) .	200mA
100mA N-Channel Sink Current (DC) (Note 8)	200mA
Peak 300mA SW Sink and Source Current (Note 8)	600mA
Peak 200mA SW Sink and Source Current (Note 8)	400mA
Peak 100mA SW Sink and Source Current (Note 8)	200mA
Operating Temperature Range	-40°C to 85°C
Junction Temperature (Notes 3, 4)	125°C
Storage Temperature Range	-65°C to 125°C

PIN CONFIGURATION

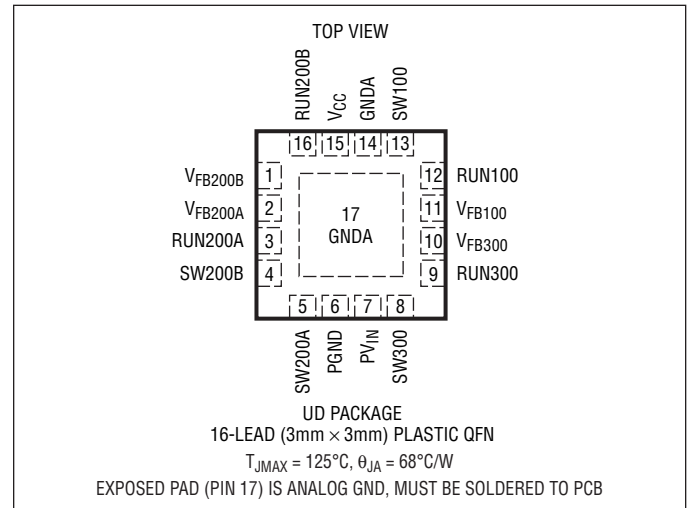

ORDER INFORMATION

LEAD FREE FINISH	TAPE AND REEL	PART MARKING	PACKAGE DESCRIPTION	TEMPERATURE RANGE
LTC3544BEUD#PBF	LTC3544BEUD#TRPBF	LCLN	16-Lead (3mm x 3mm) Plastic QFN	-40°C to 85°C
LEAD BASED FINISH	TAPE AND REEL	PART MARKING	PACKAGE DESCRIPTION	TEMPERATURE RANGE
LTC3544BEUD	LTC3544BEUD#TR	LCLN	16-Lead (3mm x 3mm) Plastic QFN	-40°C to 85°C

Consult LTC Marketing for parts specified with wider operating temperature ranges.

For more information on lead free part marking, go to: <http://www.linear.com/leadfree/>

For more information on tape and reel specifications, go to: <http://www.linear.com/tapeandreeel/>

ELECTRICAL CHARACTERISTICS

The ● denotes the specifications which apply over the full operating temperature range, otherwise specifications are at $T_A = 25^\circ\text{C}$. $V_{IN} = 3.6V$ unless otherwise noted. (Note 2)

SYMBOL	PARAMETER	CONDITIONS	MIN	TYP	MAX	UNITS
General Characteristics						
V_{IN}	Input Voltage Range		● 2.25		5.5	V
V_{FBREGx}	Regulated Feedback Voltage (Note 5)		● 0.792	0.8	0.808	V
			● 0.784	0.8	0.816	V
ΔV_{FBREGx}	Reference Voltage Line Regulation (Note 5)	$V_{IN} = 2.25V$ to $5.5V$		0.05	0.25	%/V
$V_{LOADREG}$	Output Voltage Load Regulation (Note 6)			0.5		%
I_S	Input DC Bias Current Active Mode (Pulse Skip)	$V_{FB} = 0.7V$, $I_{LOAD} = 0A$, 2.25MHz, Four Regulators Enabled		825	1100	μA
	Shutdown			0.1	2	μA
f_{OSC}	Oscillator Frequency	$V_{IN} = 3V$		2.25		MHz
		$V_{IN} = 2.5V$ to $5.5V$	● 1.8		2.7	MHz

3544bfb

ELECTRICAL CHARACTERISTICS

The ● denotes the specifications which apply over the full operating temperature range, otherwise specifications are at $T_A = 25^\circ\text{C}$. $V_{IN} = 3.6\text{V}$ unless otherwise noted.

SYMBOL	PARAMETER	CONDITIONS	MIN	TYP	MAX	UNITS
$V_{\text{RUN(HIGH)}}$	RUNx Input High Voltage		● 1.0			V
$V_{\text{RUN(LOW)}}$	RUNx Input Low Voltage				● 0.3	V
I_{LSW}	SWx Leakage	$V_{\text{RUN}} = 0\text{V}$, $V_{\text{SW}} = 0\text{V}$ or 5.5V , $V_{\text{IN}} = 5.5\text{V}$		±0.1	±1	μA
I_{RUN}	RUN Leakage Current	$V_{\text{IN}} = 5.5\text{V}$	●	±0.1	±1	μA
I_{VFB}	V_{FBx} Leakage Current				80	nA
t_{SS}	Soft-Start Period	$V_{\text{FB}} = 7.5\%$ to 92.5% Full Scale	650	875	1200	μs
V_{UVLO}	Undervoltage Lockout		●	1.9	2.25	V

Individual Regulator Characteristics

Regulator SW300 – 300mA

I_{PK}	Peak Switch Current Limit	$V_{\text{FB}} < V_{\text{FBREG}}$, Duty Cycle $< 35\%$		400	600	800	mA
I_{S300}	Input DC Bias Current—Reg SW300 Only Active Mode (Pulse Skip)	$V_{\text{FB}} = 0.7\text{V}$, $I_{\text{LOAD}} = 0\text{A}$, 2.25MHz			320		μA
R_{PFET}	$R_{\text{DS(ON)}}$ of P-Channel FET (Note 7)	$I_{\text{SW}} = 100\text{mA}$			0.55		Ω
R_{NFET}	$R_{\text{DS(ON)}}$ of N-Channel FET (Note 7)	$I_{\text{SW}} = -100\text{mA}$			0.50		Ω

Regulator SW200A – 200mA

I_{PK}	Peak Switch Current Limit	$V_{\text{FB}} < V_{\text{FBREG}}$, Duty Cycle $< 35\%$		300	400	500	mA
I_{S200}	Input DC Bias Current—Reg SW200A Only Active Mode (Pulse Skip)	$V_{\text{FB}} = 0.7\text{V}$, $I_{\text{LOAD}} = 0\text{A}$, 2.25MHz			320		μA
R_{PFET}	$R_{\text{DS(ON)}}$ of P-Channel FET (Note 7)	$I_{\text{SW}} = 100\text{mA}$			0.65		Ω
R_{NFET}	$R_{\text{DS(ON)}}$ of N-Channel FET (Note 7)	$I_{\text{SW}} = -100\text{mA}$			0.60		Ω

Regulator SW200B – 200mA

I_{PK}	Peak Switch Current Limit	$V_{\text{FB}} < V_{\text{FBREG}}$, Duty Cycle $< 35\%$		300	400	500	mA
I_{S200}	Input DC Bias Current—Reg SW200B Only Active Mode (Pulse Skip)	$V_{\text{FB}} = 0.7\text{V}$, $I_{\text{LOAD}} = 0\text{A}$, 2.25MHz			320		μA
R_{PFET}	$R_{\text{DS(ON)}}$ of P-Channel FET (Note 7)	$I_{\text{SW}} = 100\text{mA}$			0.65		Ω
R_{NFET}	$R_{\text{DS(ON)}}$ of N-Channel FET (Note 7)	$I_{\text{SW}} = -100\text{mA}$			0.60		Ω

Regulator SW100 – 100mA

I_{PK}	Peak Switch Current Limit	$V_{\text{FB}} < V_{\text{FBREG}}$, Duty Cycle $< 35\%$		200	300	400	mA
I_{S100}	Input DC Bias Current—Reg SW100B Only Active Mode (Pulse Skip)	$V_{\text{FB}} = 0.7\text{V}$, $I_{\text{LOAD}} = 0\text{A}$, 2.25MHz			320		μA
R_{PFET}	$R_{\text{DS(ON)}}$ of P-Channel FET (Note 7)	$I_{\text{SW}} = 100\text{mA}$			0.80		Ω
R_{NFET}	$R_{\text{DS(ON)}}$ of N-Channel FET (Note 7)	$I_{\text{SW}} = -100\text{mA}$			0.75		Ω

Note 1: Stresses beyond those listed under Absolute Maximum Ratings may cause permanent damage to the device. Exposure to any Absolute Maximum Rating condition for extended periods may affect device reliability and lifetime.

Note 2: The LTC3544BE is guaranteed to meet performance specifications from 0°C to 85°C . Specifications over the -40°C to 85°C operating temperature range are assured by design, characterization and correlation with statistical process controls.

Note 3: T_J is calculated from the ambient temperature T_A and power dissipation P_D according to the following formula:

$$T_J = T_A + (P_D)(68^\circ\text{C/W}).$$

Note 4: This IC includes overtemperature protection that is intended to protect the device during momentary overload conditions. Junction temperature will exceed 125°C when overtemperature is active. Continuous operation above the specified maximum operating junction temperature may impair device reliability.

Note 5: The LTC3544B is tested in a proprietary test mode that connects V_{FB} to the output of the error amplifier.

Note 6: Load regulation is inferred by measuring the regulation loop gain.

Note 7: The QFN switch on-resistance is guaranteed by correlation to wafer level measurements.

Note 8: Guaranteed by long-term current density limitations.

TYPICAL PERFORMANCE CHARACTERISTICS

V_{REF} vs Temperature at 2.25V, 3.6V, 5.5V

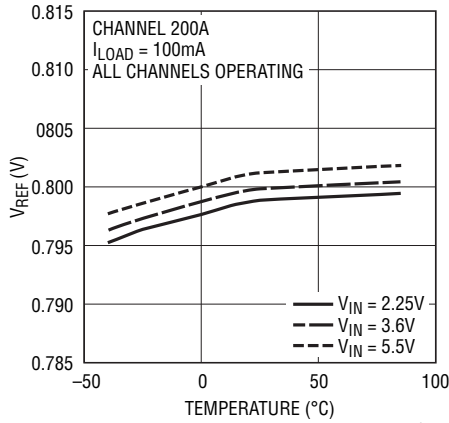

Switching Frequency vs Supply Voltage and Temperature

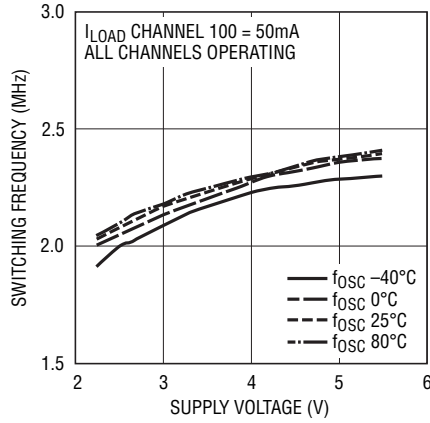

Efficiency vs Load Current 300mA Channel. All Other Channels at 50% Peak Current

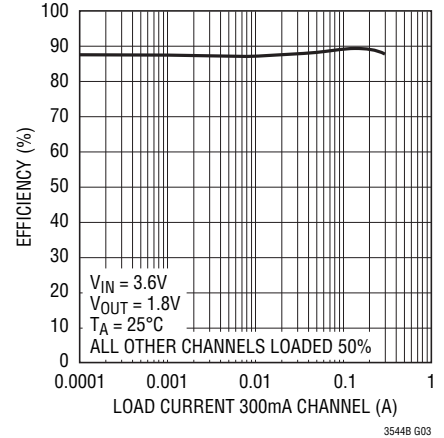

Efficiency vs Load Current 300mA Channel. All Other Channels Off

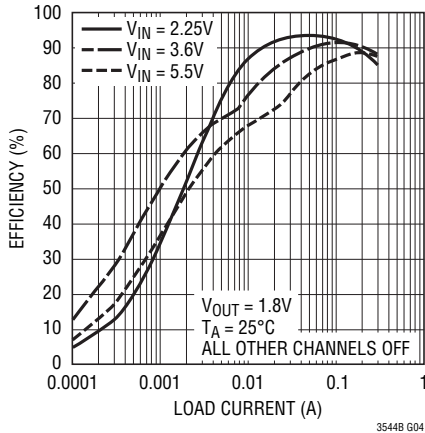

Efficiency vs Load Current 200mA Channel A. All Other Channels Off

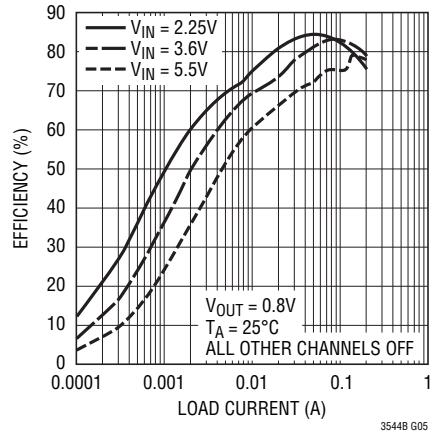

Efficiency vs Load Current 200mA Channel B. All Other Channels Off

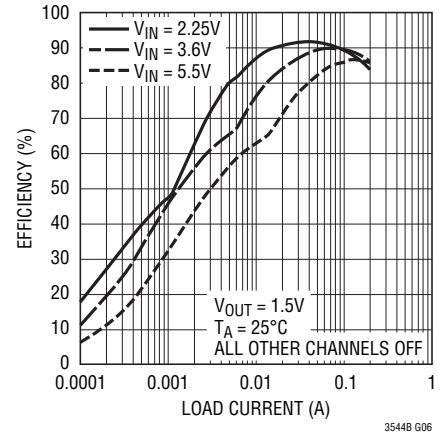

Efficiency vs Load Current 100mA Channel. All Other Channels Off

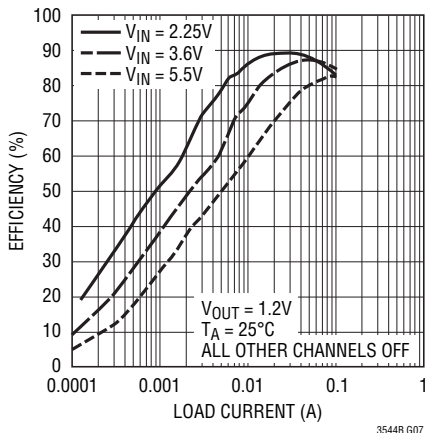

Efficiency vs Supply Voltage, All Channels 50% Loaded

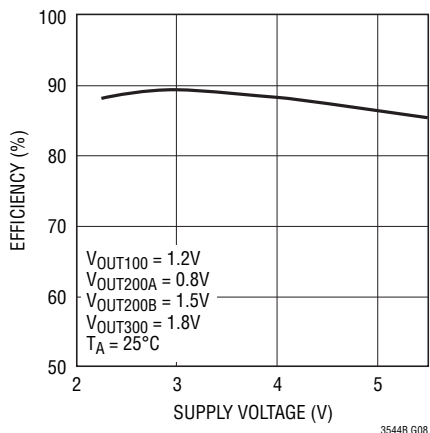

Load Regulation, All Channels

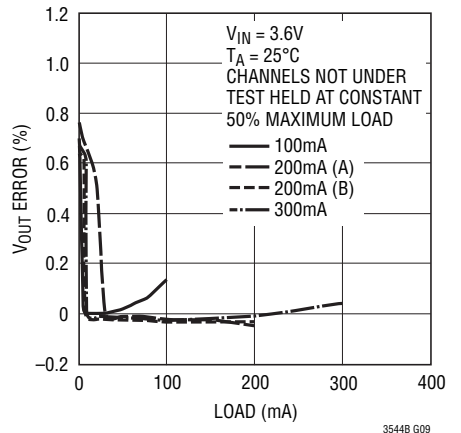

TYPICAL PERFORMANCE CHARACTERISTICS

Start-Up Curves, All Channels

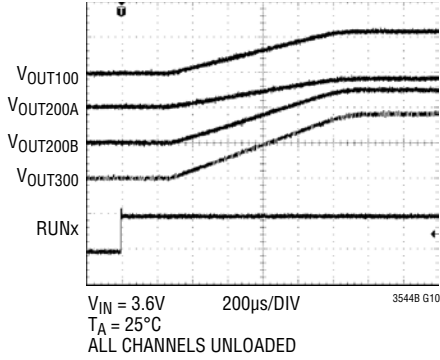

Load Step Response, 300mA Channel

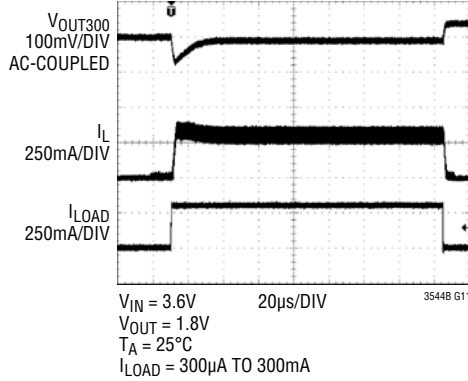

Load Step Response, 200mA Channel A

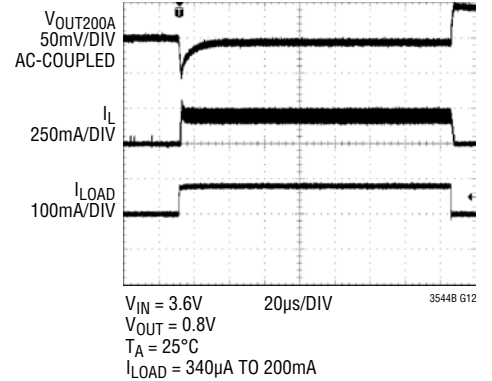

Load Step Response, 200mA Channel B

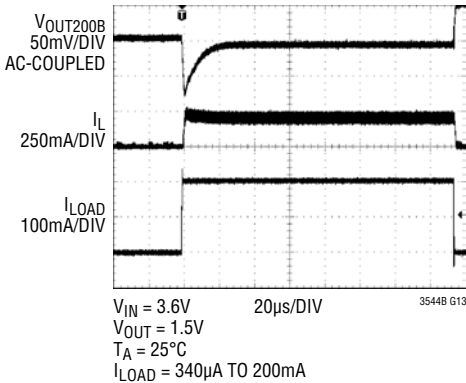

Load Step Response, 100mA Channel

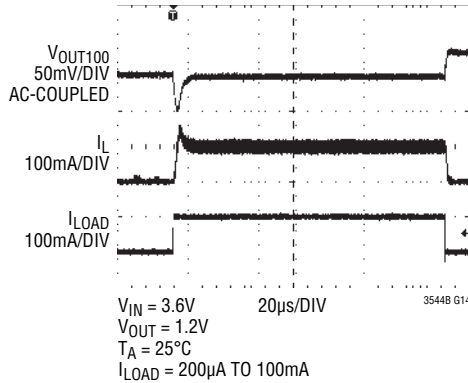

Load Step Crosstalk

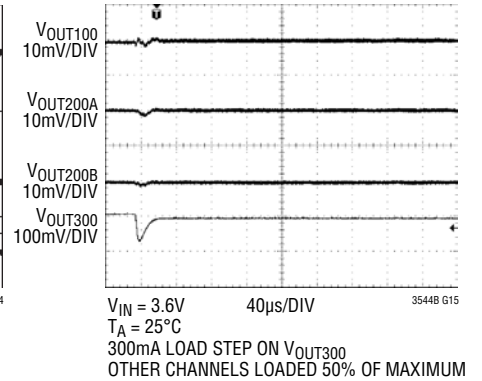

TYPICAL PERFORMANCE CHARACTERISTICS

PFET $R_{DS(ON)}$ vs Supply Voltage

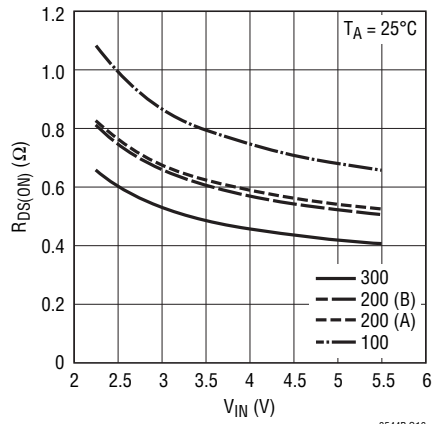

3544B G16

NFET $R_{DS(ON)}$ vs Supply Voltage

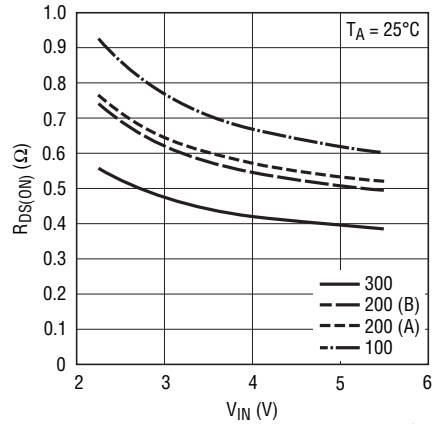

3544B G17

PFET $R_{DS(ON)}$ vs Temperature

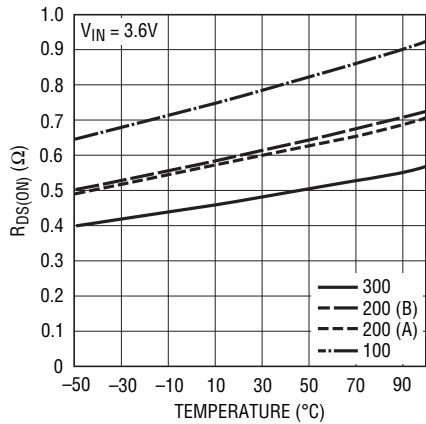

3544B G18

NFET $R_{DS(ON)}$ vs Temperature

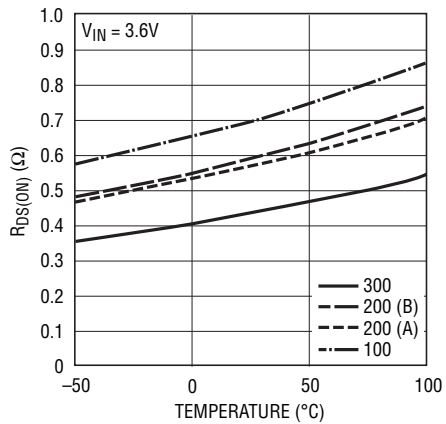

3544B G19

PIN FUNCTIONS

V_{FB200B} (Pin 1): 200mA Regulator B Feedback Pin. This pin receives the feedback voltage from an external resistive divider across the output.

V_{FB200A} (Pin 2): 200mA Regulator A Feedback Pin. This pin receives the feedback voltage from an external resistive divider across the output.

RUN200A (Pin 3): 200mA Regulator A Enable Pin. Forcing this pin to V_{IN} enables the 200mA regulator (channel A), while forcing it to GND causes the regulator to shut off.

SW200B (Pin 4): Switch Node Connection to Inductor for 200mA Regulator B. This pin connects to the drains of the internal power MOSFET switches.

SW200A (Pin 5): Switch node Connection to Inductor for 200mA Regulator A. This pin connects to the drains of the internal power MOSFET switches.

PGND (Pin 6): Power Path Return Pin for Both 200mA Regulators and the 300mA Regulator.

PV_{IN} (Pin 7): Power Path Supply Pin for Both 200mA Regulators and the 300mA Regulator. This pin must be closely decoupled to PGND, with a 4.7μF or greater ceramic capacitor.

SW300 (Pin 8): Switch Node Connection to Inductor for 300mA Regulator. This pin connects to the drains of the internal power MOSFET switches.

RUN300 (Pin 9): 300mA Regulator Enable Pin. Forcing this pin to V_{IN} enables the 300mA regulator, while forcing it to GND causes the regulator to shut off.

V_{FB300} (Pin 10): 300mA Regulator Feedback Pin. This pin receives the feedback voltage from an external resistive divider across the output.

V_{FB100} (Pin 11): 100mA Regulator Feedback Pin. This pin receives the feedback voltage from an external resistive divider across the output.

RUN100 (Pin 12): 100mA Regulator Enable Pin. Forcing this pin to V_{IN} enables the 100mA regulator, while forcing it to GND causes the 100mA regulator to shut off.

SW100 (Pin 13): Switch Node Connection to Inductor for 100mA Regulator. This pin connects to the drains of the internal power MOSFET switches.

GNDA (Pin 14, Exposed Pad Pin 17): Ground Pin for Internal Reference, Control Circuitry, and the Current Path Return for 100mA Regulator. The exposed pad must be soldered to PCB ground for electrical connection and rated thermal performance.

V_{CC} (Pin 15): Supply Pin for Internal Reference and Control Circuitry. Power path supply pin for the 100mA regulator.

RUN200B (Pin 16): 200mA Regulator B Enable Pin. Forcing this pin to V_{IN} enables the 200mA regulator (channel B), while forcing it to GND causes the regulator to shut off.

FUNCTIONAL DIAGRAMS

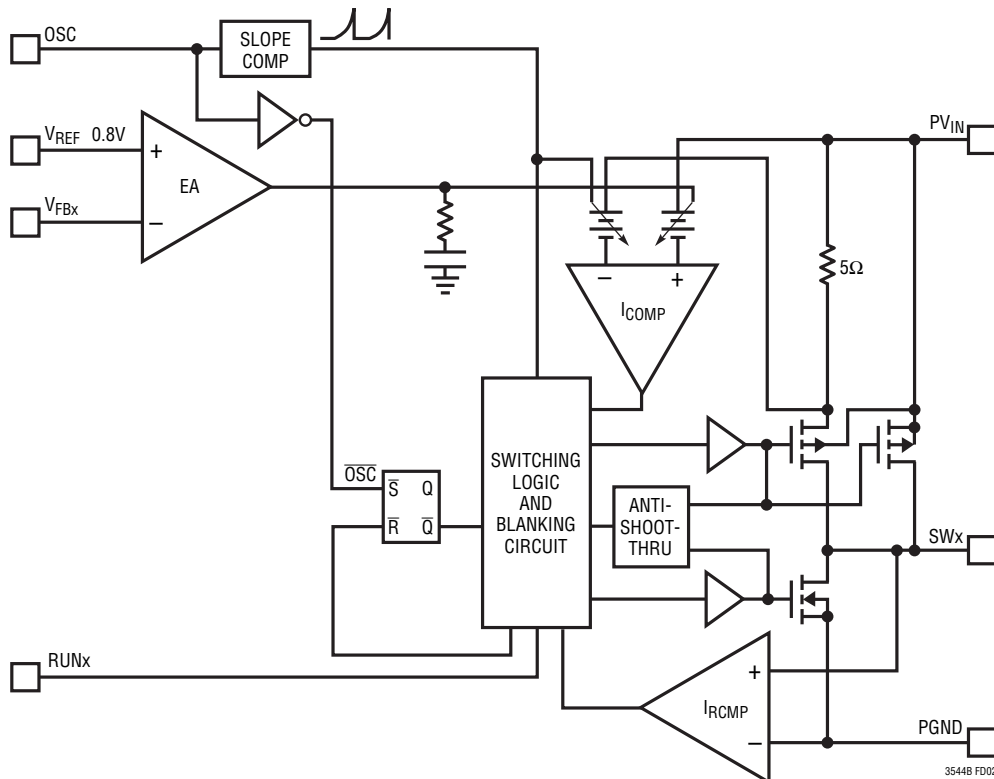
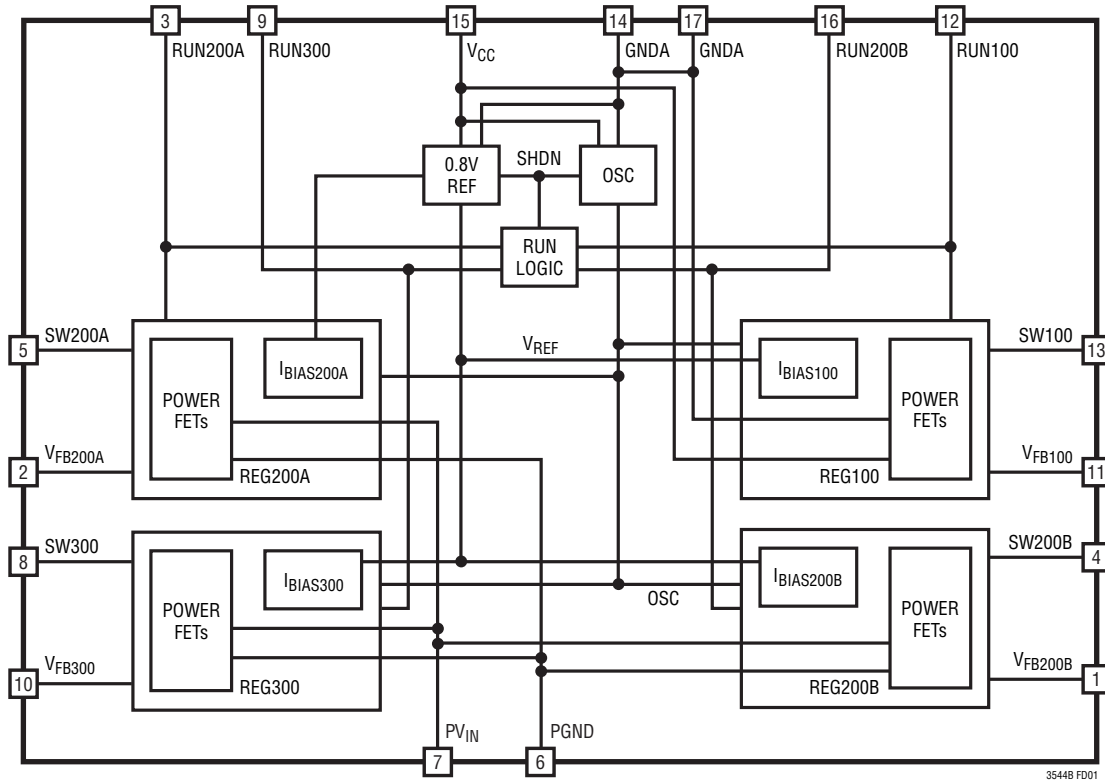

OPERATION

MAIN CONTROL LOOP

The LTC3544B uses a constant frequency, current mode step-down architecture. Both the main (P-channel MOSFET) and synchronous (N-channel MOSFET) switches are internal. During normal operation, the internal top power MOSFET is turned on each cycle when the oscillator sets the RS latch, and turned off when the current comparator, I_{COMP} , resets the RS latch. The peak inductor current at which I_{COMP} resets the RS latch, is controlled by the output of error amplifier EA. When the load current increases, it causes a slight decrease in the feedback voltage FB relative to the 0.8V reference, which in turn, causes the EA amplifier's output voltage to increase until the average inductor current matches the new load current. While the top MOSFET is off, the bottom MOSFET is turned on until either the inductor current starts to reverse, as indicated by the current reversal comparator, I_{RCMP} , or the beginning of the next clock cycle.

PULSE SKIPPING MODE OPERATION

At light loads, the inductor current may reach zero or reverse on each pulse. The bottom MOSFET is turned off by the current reversal comparator, I_{RCMP} , and the switch voltage will ring. This is discontinuous mode operation, and is normal behavior for the switching regulator. At very light loads, the LTC3544B will automatically skip pulses to maintain output regulation.

SOFT-START

Soft-start reduces surge currents on V_{IN} and output overshoot during start-up. Soft-start on the LTC3544B is implemented by internally ramping the reference signal fed to the error amplifier over approximately a 1ms period. Figure 1 shows the behavior of the four regulator channels during soft-start.

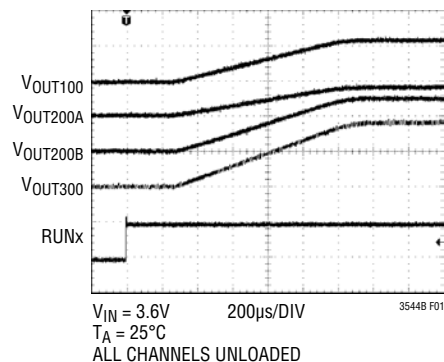

Figure 1. Regulator Soft-Start

Short-Circuit Protection

Short circuit protection is achieved by monitoring the inductor current. When the current exceeds a predetermined level, the main switch is turned off, and the synchronous switch is turned on long enough to allow the current in the inductor to decay below the fault threshold. This prevents a catastrophic inductor current, run-away condition, but will still provide current to the output. Output voltage regulation in this condition is not achieved.

DROPOUT OPERATION

As the input supply voltage decreases to a value approaching the output voltage, the duty cycle increases toward the maximum on-time. Further reduction of the supply voltage forces the main switch to remain on for more than one cycle until it reaches 100% duty cycle. The output voltage will then be determined by the input voltage minus the voltage drop across the P-channel MOSFET and the inductor. An important detail to remember is that at low input supply voltages, the $R_{DS(ON)}$ of the P-channel switch increases (see Typical Performance Characteristics). Therefore, the user should calculate the power dissipation when the LTC3544B is used at 100% duty cycle with low input voltage (See Thermal Considerations in the Applications Information section).

APPLICATIONS INFORMATION

The basic LTC3544B application circuit is shown on the first page of this data sheet. External component selection is driven by the load requirement and begins with the selection of L followed by C_{IN} and C_{OUT} .

Inductor Selection

For most applications, the value of the inductor will fall in the range of $1\mu\text{H}$ to $10\mu\text{H}$. Its value is chosen based on the desired ripple current. Large inductor values lower ripple current and small inductor values result in higher ripple currents. Higher V_{IN} or V_{OUT} also increases the ripple current as shown in Equation 1. A reasonable starting point for setting ripple current for the 300mA regulator is $\Delta I_L = 120\text{mA}$ (40% of 300mA).

$$\Delta I_L = \frac{1}{(f)(L)} V_{OUT} \left(1 - \frac{V_{OUT}}{V_{IN}} \right) \quad (1)$$

The DC current rating of the inductor should be at least equal to the maximum load current plus half the ripple current to prevent core saturation. Thus, a 360mA rated inductor should be enough for most applications (300mA + 60mA). For better efficiency, choose a low DCR inductor.

Inductor Core Selection

Different core materials and shapes will change the size/current and price/current relationship of an inductor. Toroid or shielded pot cores in ferrite or permalloy materials are small and don't radiate much energy, but generally cost more than powdered iron core inductors with similar electrical characteristics. The choice of which style inductor to use often depends more on the price vs. size requirements and any radiated field/EMI requirements than on what the LTC3544B requires to operate. Table 1 shows typical surface mount inductors that work well in LTC3544B applications.

Table 1. Representative Surface Mount Inductors

PART NUMBER	VALUE (μH)	DCR (Ω MAX)	MAX DC CURRENT (A)	W \times L \times H (mm^3)
Sumida CDH2D09B	10	0.47	0.48	$3.0 \times 2.8 \times 1.0$
	6.4	0.32	0.6	
	4.7	0.218	0.7	
	3.3	0.15	0.85	
Würth TPC744029	10	0.50	0.50	$2.8 \times 2.8 \times 1.35$
	6.8	0.38	0.65	
	4.7	0.210	0.80	
	3.3	0.155	0.95	
TDK VLF3010AT	10	0.67	0.49	$2.8 \times 2.6 \times 1.0$
	6.8	0.39	0.61	
	4.7	0.28	0.70	
	3.3	0.17	0.87	

C_{IN} and C_{OUT} Selection

In continuous mode, a worst-case estimate for the input current ripple can be determined by assuming that the source current of the top MOSFET is a square wave of duty cycle V_{OUT}/V_{IN} , and amplitude $I_{OUT(MAX)}$. To prevent large voltage transients, a low ESR input capacitor sized for the maximum RMS current must be used. The maximum RMS capacitor current is given by:

$$I_{RMS} \cong I_{OUT(MAX)} \frac{\sqrt{V_{OUT}(V_{IN} - V_{OUT})}}{V_{IN}}$$

This formula has a maximum at $V_{IN} = 2V_{OUT}$, where $I_{RMS} = I_{OUT}/2$. This simple worst-case condition is commonly used for design. Note that the capacitor manufacturer's ripple current ratings are often based on 2000 hours of life (non-ceramic capacitors). This makes it advisable to further de-rate the capacitor, or choose a capacitor rated at a higher temperature than required. Always consult the manufacturer if there is any question.

The selection of C_{OUT} is driven by the required effective series resistance (ESR). Typically, once the ESR requirement for C_{OUT} has been met, the RMS current rating

APPLICATIONS INFORMATION

generally far exceeds the $I_{\text{RIPPLE(P-P)}}$ requirement. The output ripple ΔV_{OUT} is determined by:

$$\Delta V_{\text{OUT}} \cong \Delta I_L \left(\text{ESR} + \frac{1}{8 \cdot f \cdot C_{\text{OUT}}} \right)$$

where f = operating frequency, C_{OUT} = output capacitance and ΔI_L = ripple current in the inductor. For a fixed output voltage, the output ripple is highest at maximum input voltage since ΔI_L increases with input voltage.

Using Ceramic Input and Output Capacitors

Higher value, lower cost, ceramic capacitors are now widely available in smaller case sizes. Their high ripple current, high voltage rating and low ESR make them ideal for switching regulator applications. Because the LTC3544B's control loop does not depend on the output capacitor's ESR for stable operation, ceramic capacitors can be used freely to achieve very low output ripple and small circuit size.

However, care must be taken when ceramic capacitors are used at the input and the output. When a ceramic capacitor is used at the input and the power is supplied by a wall adapter through long wires, a load step at the output can induce ringing at the input, V_{IN} . At best, this ringing can couple to the output and be mistaken as loop instability. At worst, a sudden inrush of current through the long wires can potentially cause a voltage spike at V_{IN} , large enough to damage the part.

When choosing the input and output ceramic capacitors, choose the X5R or X7R dielectric formulations. These dielectrics have the best temperature and voltage characteristics of all the ceramics for a given value and size.

Output Voltage Programming

The output voltage is set by tying V_{FB} to a resistive divider according to the following formula:

$$V_{\text{OUT}} = 0.8V \left(1 + \frac{R2}{R1} \right)$$

The external resistive divider is connected to the output allowing remote voltage sensing as shown in Figure 2.

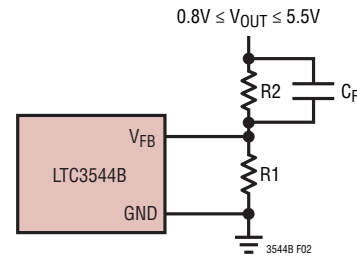

Figure 2. Setting the LTC3544B Output Voltage

Keeping the current in the resistors small maximizes the efficiency, but making them too small may allow stray capacitance to cause noise problems or reduce the phase margin of the control loop. It is recommended that the total feedback resistor string be kept to under 100k.

To improve the frequency response of the control loop, a feed forward capacitor, C_F , may be used. Great care should be taken to route the feedback line away from noise sources such as the inductor of the SW line.

Efficiency Considerations

The efficiency of a switching regulator is equal to the output power divided by the input power times 100%. It is often useful to analyze individual losses to determine what is limiting the efficiency and which change would produce the most improvement. Efficiency can be expressed as: Efficiency = 100% – (L1 + L2 + L3 + ...) where L1, L2, etc. are the individual losses as a percentage of input power.

Although all dissipative elements in the circuit produce losses, two main sources usually account for most of the losses in LTC3544B circuits: V_{IN} quiescent current and I^2R losses. V_{IN} quiescent current loss dominates the efficiency loss at low load currents, whereas the I^2R loss dominates the efficiency loss at medium to high load currents.

1. The quiescent current is due to two components: the DC bias current as given in the electrical characteristics and the internal main switch and synchronous switch gate charge currents. The gate charge current results from switching the gate capacitance of the internal power MOSFET switches. Each time the gate is switched from high to low to high again, a packet of charge, dQ , moves from PV_{IN} to ground. The resulting dQ/dt is the current out of PV_{IN} that is typically larger than the DC bias current and

APPLICATIONS INFORMATION

proportional to frequency. Both the DC bias and gate charge losses are proportional to P_{VIN} and thus their effects will be more pronounced at higher supply voltages.

2. I^2R losses are calculated from the resistances of the internal switches, R_{SW} , and external inductor R_L . In continuous mode, the average output current flowing through inductor L is “chopped” between the main switch and the synchronous switch. Thus, the series resistance looking into the SW pin is a function of both top and bottom MOSFET $R_{DS(ON)}$ and the duty cycle (DC) as follows:

$$R_{SW} = (R_{DS(ON)TOP})(DC) + (R_{DS(ON)BOT})(1 - DC)$$

The $R_{DS(ON)}$ for both the top and bottom MOSFETs can be obtained from the Typical Performance Characteristics curves. Thus, to obtain I^2R losses, simply add R_{SW} to R_L and multiply the result by the square of the average output current.

Other losses when in switching operation, including C_{IN} and C_{OUT} ESR dissipative losses and inductor core losses, generally account for less than 2% total additional loss.

Thermal Considerations

The LTC3544B requires the package backplane metal to be well soldered to the PC board. This gives the QFN package exceptional thermal properties, making it difficult in normal operation to exceed the maximum junction temperature of the part. In most applications the LTC3544B does not dissipate much heat due to its high efficiency. In applications where the LTC3544B is running at high ambient temperature with low supply voltage and high duty cycles, such as in dropout, the heat dissipated may exceed the maximum junction temperature of the part if it is not well thermally grounded. If the junction temperature reaches approximately 150°C, the power switches will be turned off and the SW nodes will become high impedance.

To avoid the LTC3544B from exceeding the maximum junction temperature, the user will need to do some thermal analysis. The goal of the thermal analysis is to determine whether the power dissipated exceeds the maximum junction temperature of the part. The temperature rise is given by:

$$T_R = P_D \cdot \theta_{JA}$$

where P_D is the power dissipated by the regulator and θ_{JA} is the thermal resistance from the junction of the die to the ambient temperature.

The junction temperature, T_J , is given by:

$$T_J = T_A + T_R$$

where T_A is the ambient temperature.

As an example, consider the LTC3544B in dropout at an input voltage of 2.5V, a total load current (all four regulators) of 800mA and an ambient temperature of 85°C. From the Typical Performance graphs of switch resistance, the $R_{DS(ON)}$ of the 300mA P-channel switch at 85°C can be estimated as 0.67Ω. Therefore, power dissipated by the 300mA channel is:

$$P_D = I_{LOAD}^2 \cdot R_{DS(ON)} = 60mW$$

Similar analysis on the other channels gives a total power dissipation of 138mW. For the 3mm × 3mm QFN package, the θ_{JA} is 68°C/W. Thus, the junction temperature of the regulator is:

$$T_J = 85^\circ\text{C} + (0.138)(68) = 94.4^\circ\text{C}$$

which is well below the maximum junction temperature of 125°C.

Note that at higher supply voltages, the junction temperature is lower due to reduced switch resistance $R_{DS(ON)}$.

Checking Transient Response

The regulator loop response can be checked by looking at the load transient response. Switching regulators take several cycles to respond to a step in load current. When a load step occurs, V_{OUT} immediately shifts by an amount equal to $(\Delta I_{LOAD} \cdot ESR)$, where ESR is the effective series resistance of C_{OUT} . ΔI_{LOAD} also begins to charge or discharge C_{OUT} , which generates a feedback error signal. The regulator loop then acts to return V_{OUT} to its steady-state value. During this recovery time V_{OUT} can be monitored for overshoot or ringing that would indicate a stability problem. For a detailed explanation of switching control loop theory, see Application Note 76.

APPLICATIONS INFORMATION

A second, more severe transient is caused by switching in loads with large ($>1\mu\text{F}$) supply bypass capacitors. The discharged bypass capacitors are effectively put in parallel with C_{OUT} , causing a rapid drop in V_{OUT} . No regulator can deliver enough current to prevent this problem if the load switch resistance is low and it is driven quickly. The only solution is to limit the rise time of the switch drive so that the load rise time is limited to approximately $(25 \cdot C_{LOAD})$. Thus, a $10\mu\text{F}$ capacitor charging to 3.3V would require a $250\mu\text{s}$ rise time, limiting the charging current to about 130mA .

PC Board Layout Checklist

When laying out the printed circuit board, the following checklist should be used to ensure proper operation of the LTC3544B. These items are also illustrated graphically in Figures 3 and 4. Check the following in your layout:

1. The power traces, consisting of the PGND trace, the GNDA trace, the SW traces, the PV_{IN} trace and the V_{CC} trace should be kept short, direct and wide.
2. Does each of the V_{FBx} pins connect directly to the respective feedback resistors? The resistive dividers must be connected between the (+) plate of the corresponding output filter capacitor (e.g. C13) and GNDA. If the circuit being powered is at such a distance from the part where voltage drops along circuit traces are large, consider a Kelvin connection from the powered circuit back to the resistive dividers.
3. Keep C8 and C9 as close to the part as possible.
4. Keep the switching nodes (SWx) away from the sensitive V_{FBx} nodes.
5. Keep the ground connected plates of the input and output capacitors as close as possible.
6. Care should be taken to provide enough space between unshielded inductors in order to minimize any transformer coupling.

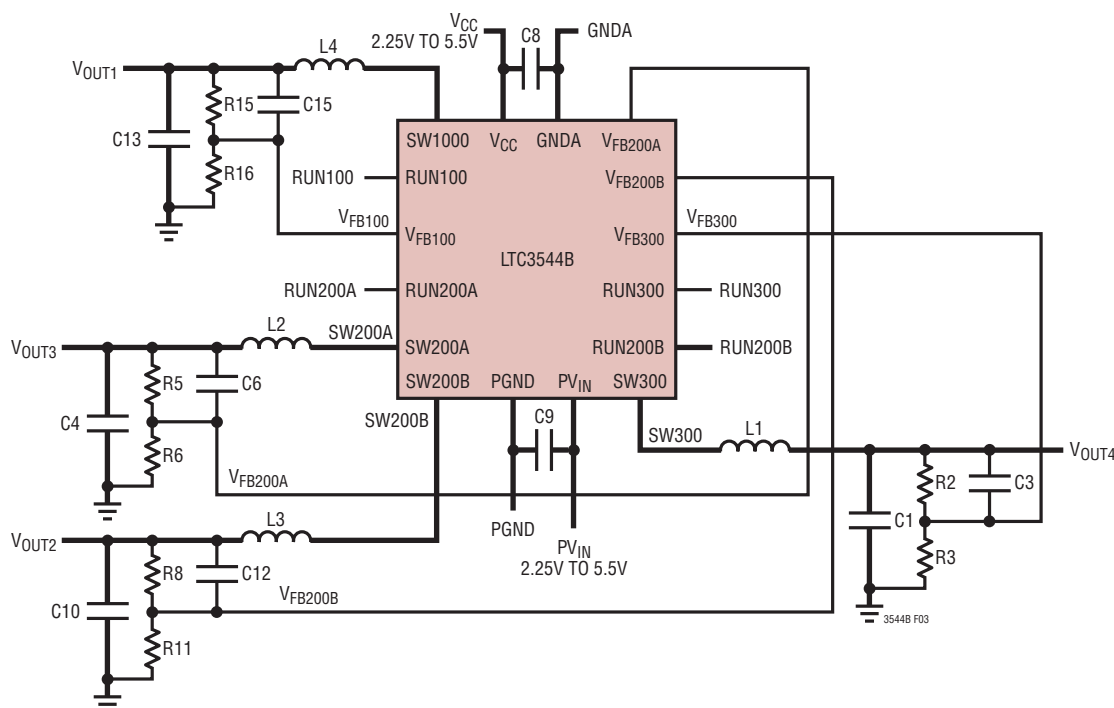

Figure 3. LTC3544B Layout Diagram

APPLICATIONS INFORMATION

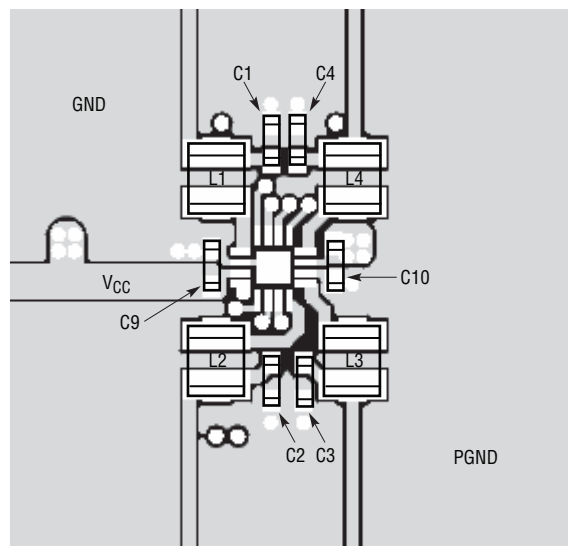

Figure 4

Design Example

As a design example, consider using the LTC3544B as a portable application with a Li-Ion battery. The battery provides V_{IN} ranging from 2.8V to 4.2V. The demand at 2.5V is 250mA necessitating the use of the 300mA output for this requirement.

Beginning with this channel, first calculate the inductor value for about 35% ripple current (100mA in this example) at maximum V_{IN} . Using a form of equation:

$$L4 = \frac{2.5V}{2.25MHz \cdot 100mA} \left(1 - \frac{2.5V}{4.2V} \right) = 4.5\mu H$$

For the inductor, use the closest standard value of 4.7 μ H. A 4.7 μ F capacitor should be sufficient for the output capacitor. A larger output capacitor will attenuate the load transient response, but increase the settling time. A value for $C_{IN} = 4.7\mu F$ should suffice as the source impedance of a Li-Ion battery is very low.

The feedback resistors program the output voltage. Minimizing the current in these resistors will maximize efficiency at very light loads, but totals on the order of 200k are a good compromise between efficiency and immunity to any adverse effects of PCB parasitic capacitance on the feedback pins. Choosing 10 μ A with 0.8V feedback voltage makes $R7 = 80k$. A close standard 1% resistor is 76.8k. Using:

$$R8 = \left(\frac{V_{OUT}}{0.8} - 1 \right) \cdot R7 = 163.2k$$

The closest standard 1% resistor is 162k. An optional 20pF feedback capacitor may be used to improve transient response. The component values for the other channels are chosen in a similar fashion.

Figure 5 shows the complete schematic for this example, along with the efficiency curve and transient response for the 300mA channel.

APPLICATIONS INFORMATION

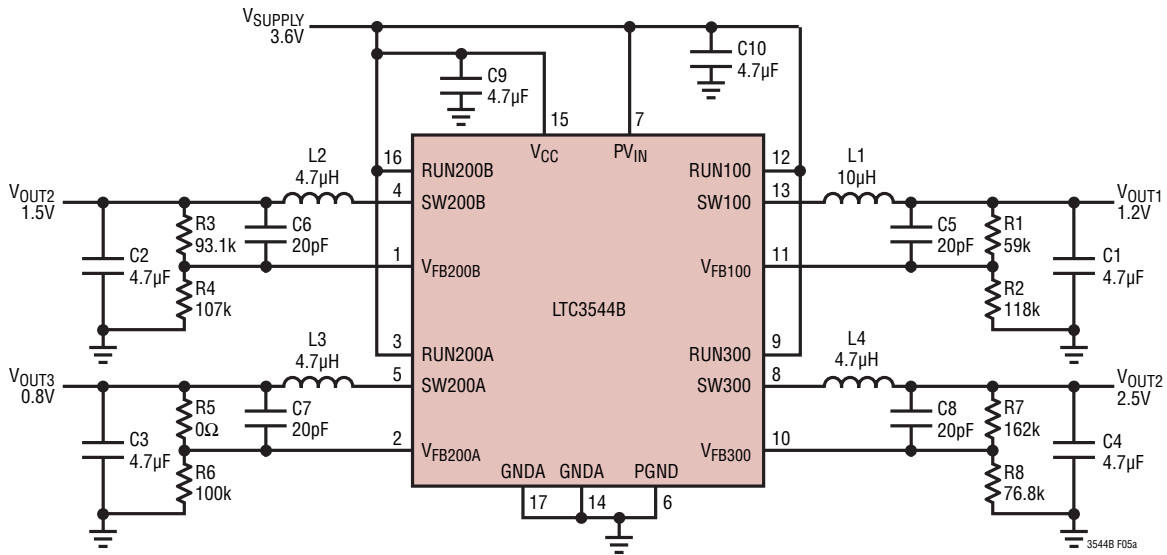
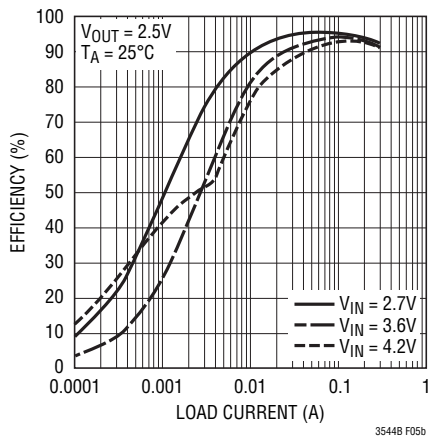
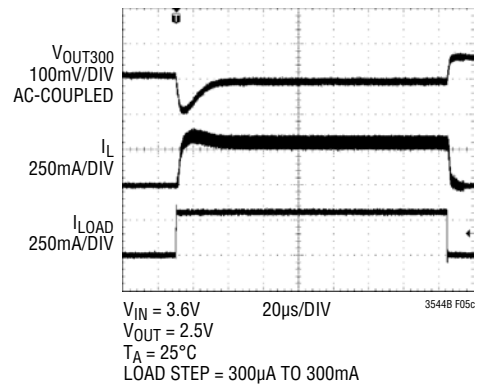

Figure 5

Efficiency vs Output Current—300mA Channel, All Other Channels Off



Transient Response



PACKAGE DESCRIPTION

UD Package
16-Lead Plastic QFN (3mm × 3mm)
 (Reference LTC DWG # 05-08-1691)

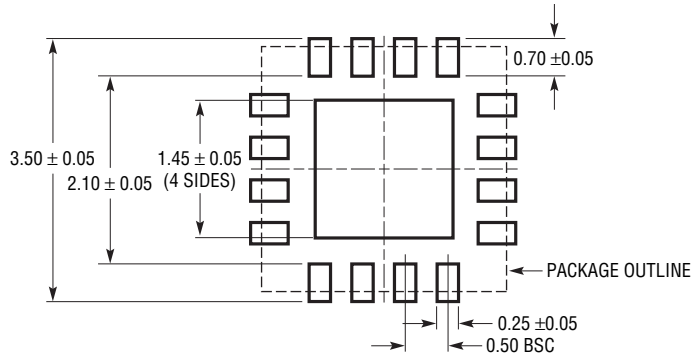

RECOMMENDED SOLDER PAD PITCH AND DIMENSIONS

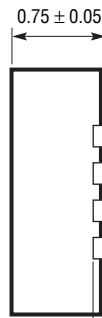
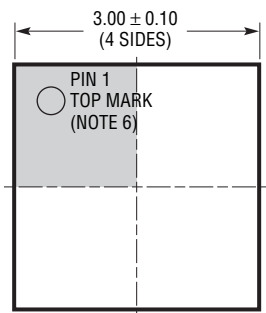

BOTTOM VIEW—EXPOSED PAD

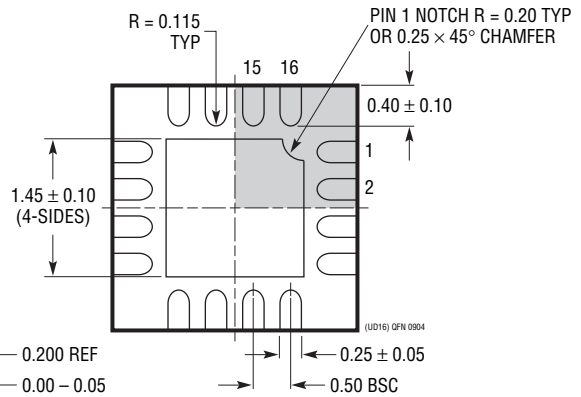

NOTE:

1. DRAWING CONFORMS TO JEDEC PACKAGE OUTLINE MO-220 VARIATION (WEED-2)
2. DRAWING NOT TO SCALE
3. ALL DIMENSIONS ARE IN MILLIMETERS
4. DIMENSIONS OF EXPOSED PAD ON BOTTOM OF PACKAGE DO NOT INCLUDE MOLD FLASH. MOLD FLASH, IF PRESENT, SHALL NOT EXCEED 0.15mm ON ANY SIDE
5. EXPOSED PAD SHALL BE SOLDER PLATED
6. SHADED AREA IS ONLY A REFERENCE FOR PIN 1 LOCATION ON THE TOP AND BOTTOM OF PACKAGE

REVISION HISTORY (Revision history begins at Rev B)

REV	DATE	DESCRIPTION	PAGE NUMBER
B	5/10	Changes to Order Information Section	2
		Pin 14 and Pin 17 Paragraphs Combined in Pin Functions	7
		Updates to Functional Diagrams	8
		Updated Related Parts	18

LTC3544B

RELATED PARTS

PART NUMBER	DESCRIPTION	COMMENTS
LTC3544	Quad 100mA/200mA/200mA/300mA, 2.25MHz Synchronous Step-Down DC/DC Converter	95% Efficiency, $V_{IN(MIN)}$: 2.3V to 5.5V, $V_{OUT(MIN)}$ = 0.8V, I_Q = 70 μ A, I_{SD} < 1 μ A, 3mm \times 3mm QFN-16 Package
LTC3545/ LTC3545-1	Triple, 800mA \times 3, 2.25MHz Synchronous Step-Down DC/DC Converter	95% Efficiency, $V_{IN(MIN)}$: 2.3V to 5.5V, $V_{OUT(MIN)}$ = 0.6V, I_Q = 58 μ A, I_{SD} < 1 μ A, 3mm \times 3mm QFN-16 Package
LTC3562	Quad, I ² C Interface, 600mA/600mA/400mA/400mA, 2.25MHz Synchronous Step-Down DC/DC Converter	95% Efficiency, $V_{IN(MIN)}$: 2.9V to 5.5V, $V_{OUT(MIN)}$ = 0.425V, I_Q = 100 μ A, I_{SD} < 1 μ A, 3mm \times 3mm QFN-20 Package
LTC3547/ LTC3547B	Dual 300mA, 2.25MHz, Synchronous Step-Down DC/DC Converter	95% Efficiency, $V_{IN(MIN)}$: 2.5V to 5.5V, $V_{OUT(MIN)}$ = 0.6V, I_Q = 40 μ A, I_{SD} < 1 μ A, DFN-8 Package
LTC3417A-2	Dual 1.5A/1A, 4MHz, Synchronous Step-Down DC/DC Converter	95% Efficiency, $V_{IN(MIN)}$: 2.3V to 5.5V, $V_{OUT(MIN)}$ = 0.8V, I_Q = 125 μ A, I_{SD} < 1 μ A, TSSOP-16E, 3mm \times 5mm DFN-16 Packages
LTC3407A/ LTC3407A-2	Dual 600mA/600mA 1.5MHz, Synchronous Step-Down DC/DC Converter	95% Efficiency, $V_{IN(MIN)}$: 2.5V to 5.5V, $V_{OUT(MIN)}$ = 0.6V, I_Q = 40 μ A, I_{SD} < 1 μ A, MS10E, 3mm \times 3mm DFN-10 Packages
LTC3419/ LTC3419-1	Dual 600mA/600mA 2.25MHz, Synchronous Step-Down DC/DC Converter	95% Efficiency, $V_{IN(MIN)}$: 2.5V to 5.5V, $V_{OUT(MIN)}$ = 0.6V, I_Q = 35 μ A, I_{SD} < 1 μ A, MS10, 3mm \times 3mm DFN-10 Packages
LTC3548/ LTC3548-1/ LTC3548-2	Dual 400mA and 800mA I_{OUT} , 2.25MHz, Synchronous Step-Down DC/DC Converter	95% Efficiency, $V_{IN(MIN)}$: 2.5V to 5.5V, $V_{OUT(MIN)}$ = 0.6V, I_Q = 40 μ A, I_{SD} < 1 μ A, MS10E, 3mm \times 3mm DFN-10 Packages

X-ON Electronics

Largest Supplier of Electrical and Electronic Components

Click to view similar products for [Switching Voltage Regulators](#) category:

Click to view products by [Analog Devices](#) manufacturer:

Other Similar products are found below :

[FAN53610AUC33X](#) [FAN53611AUC123X](#) [FAN48610BUC33X](#) [FAN48610BUC45X](#) [FAN48617UC50X](#) [R3](#) [430464BB](#) [KE177614](#)
[MAX809TTR](#) [NCV891234MW50R2G](#) [NCP81103MNTXG](#) [NCP81203PMNTXG](#) [NCP81208MNTXG](#) [NCP81109GMNTXG](#)
[SCY1751FCCT1G](#) [NCP81109JMNTXG](#) [AP3409ADNTR-G1](#) [NCP81241MNTXG](#) [LTM8064IY](#) [LT8315EFE#TRPBF](#) [LTM4664EY#PBF](#)
[LTM4668AIY#PBF](#) [NCV1077CSTBT3G](#) [XCL207A123CR-G](#) [MPM54304GMN-0002](#) [MPM54304GMN-0004](#) [MPM54304GMN-0003](#)
[AP62300Z6-7](#) [MP8757GL-P](#) [MIC23356YFT-TR](#) [LD8116CGL](#) [HG2269M/TR](#) [OB2269](#) [XD3526](#) [U6215A](#) [U6215B](#) [U6620S](#) [LTC3412IFE](#)
[LT1425IS](#) [MAX25203BATJA/VY+](#) [MAX77874CEWM+](#) [XC9236D08CER-G](#) [MP3416GJ-P](#) [BD9S201NUX-CE2](#) [MP5461GC-Z](#)
[MPQ4415AGQB-Z](#) [MPQ4590GS-Z](#) [MAX38640BENT18+T](#) [MAX77511AEWB+](#) [MAX20406AFOD/VY+](#)